



Veterans World Judo Championships 2016

(USA Fort Lauderdale, 18-21 November 2016)

M1 -66 kg

11 Judoka

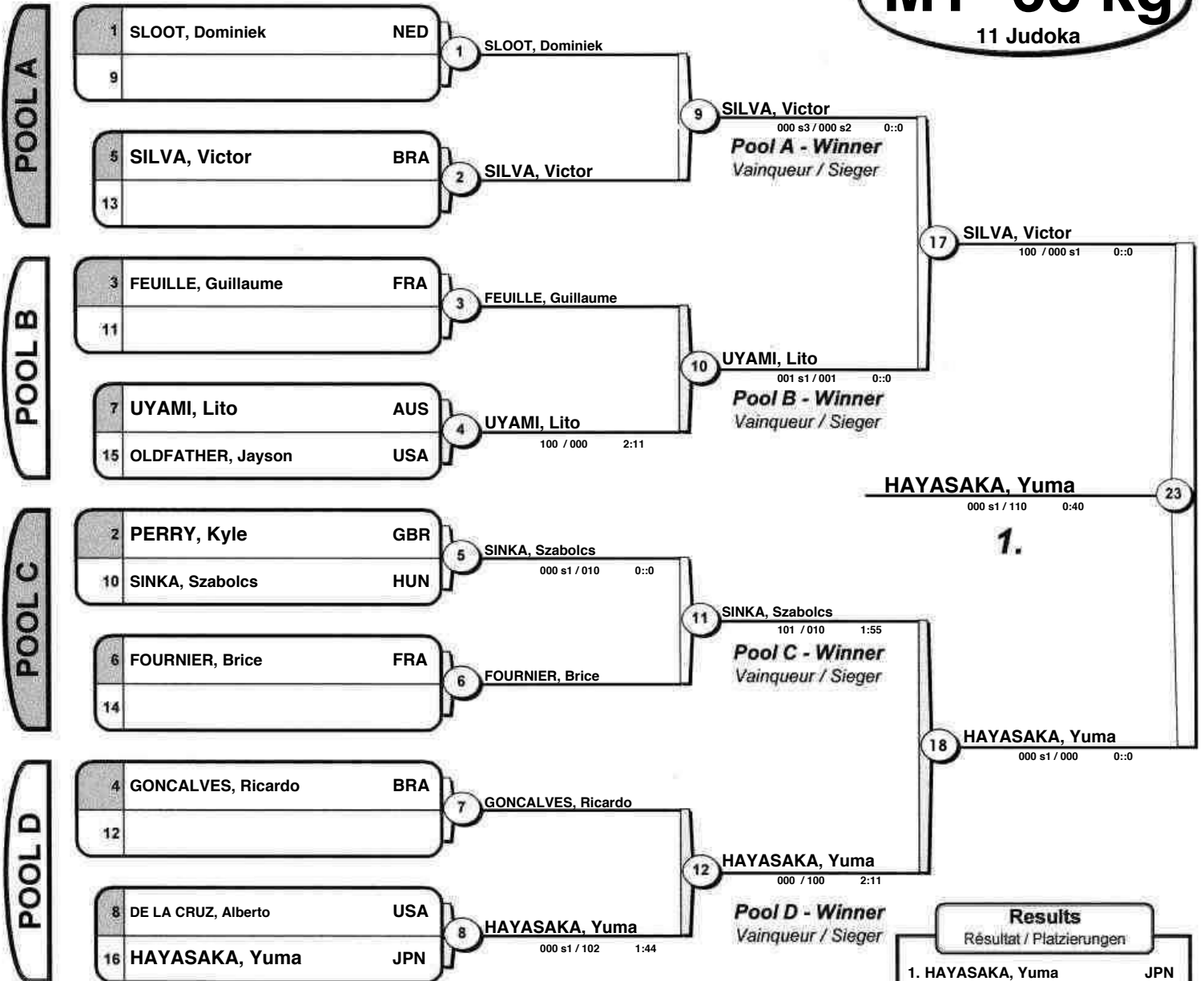

Results		
Résultat / Platzierungen		
1.	HAYASAKA, Yuma	JPN
2.	SILVA, Victor	BRA
3.	SINKA, Szabolcs	HUN
3.	PERRY, Kyle	GBR
5.	SLOOT, Dominiek	NED
5.	UYAMI, Lito	AUS
7.	FEUILLE, Guillaume	FRA
7.	GONCALVES, Ricardo	BRA

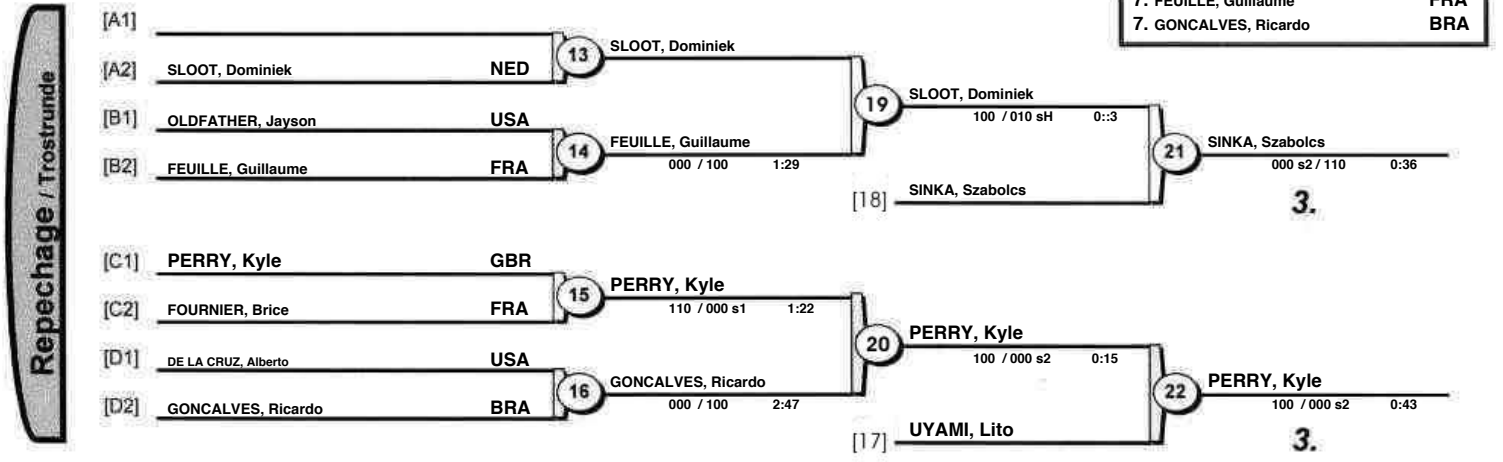



Veterans World Judo Championships 2016

(USA Fort Lauderdale, 18-21 November 2016)

M1 -73 kg

15 Judoka

POOL A

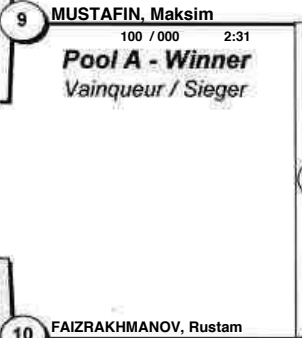
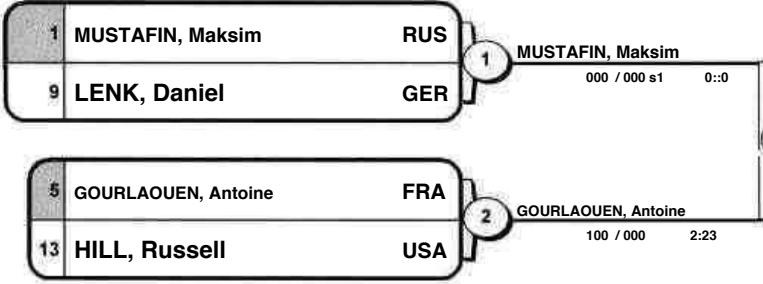

POOL B

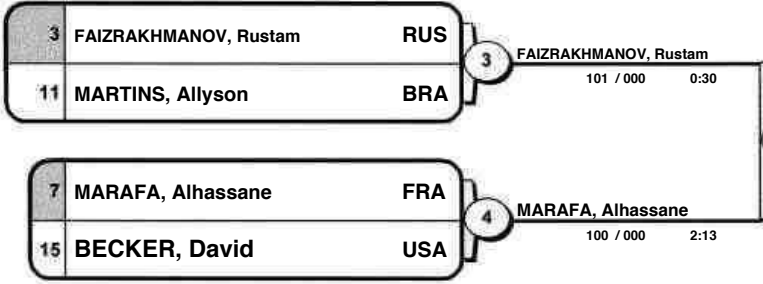

POOL C

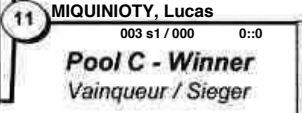
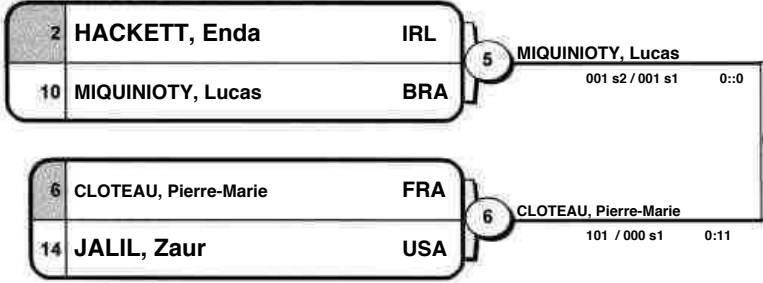

POOL D

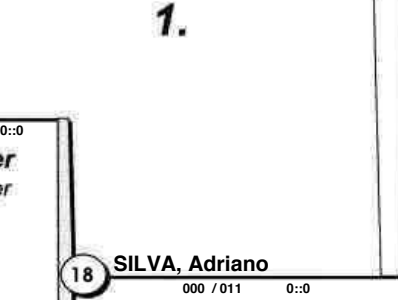
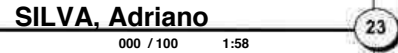
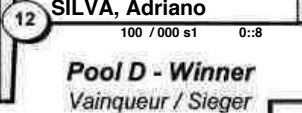
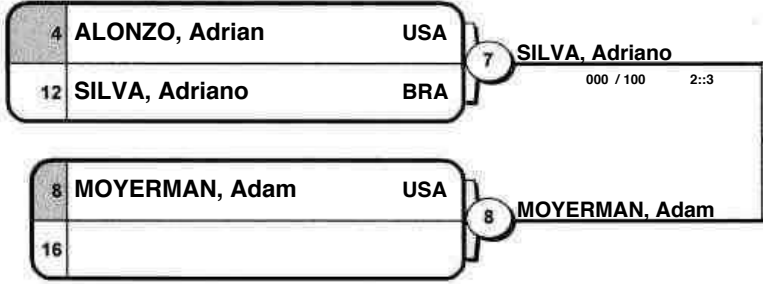

Results		
Résultat / Platzierungen		
1.	SILVA, Adriano	BRA
2.	MUSTAFIN, Maksim	RUS
3.	MIQUINIOTY, Lucas	BRA
3.	MOYERMAN, Adam	USA
5.	LENK, Daniel	GER
5.	FAIZRAKHMANOV, Rustam	RUS
7.	MARTINS, Allyson	BRA
7.	CLOTEAU, Pierre-Marie	FRA

Repechage / Trostrunde

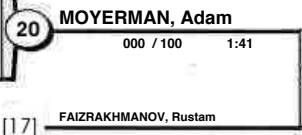
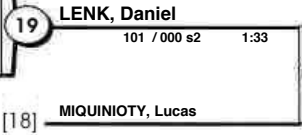
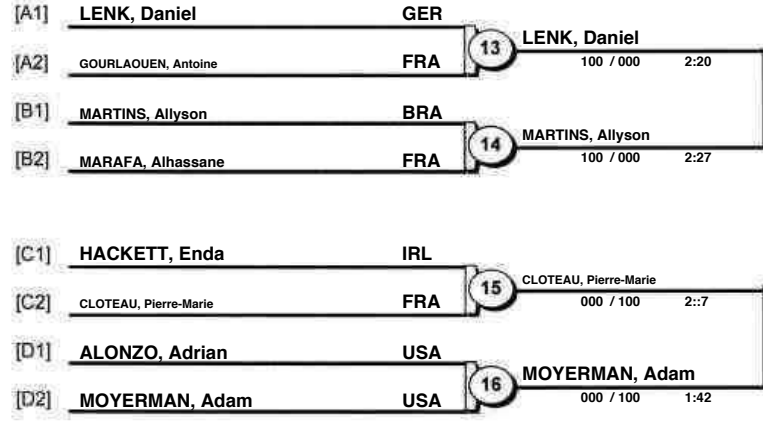



Veterans World Judo Championships 2016

(USA Fort Lauderdale, 18-21 November 2016)

M1 -81 kg

16 Judoka

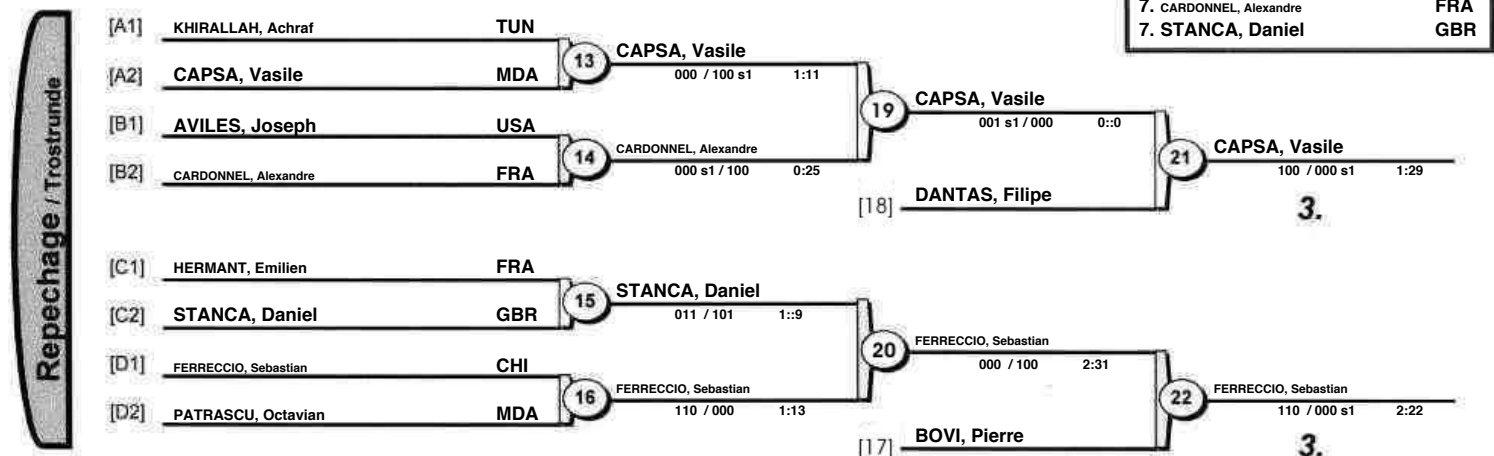
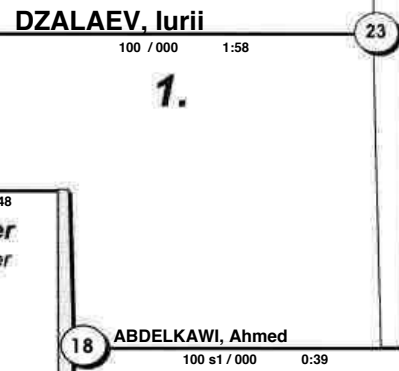
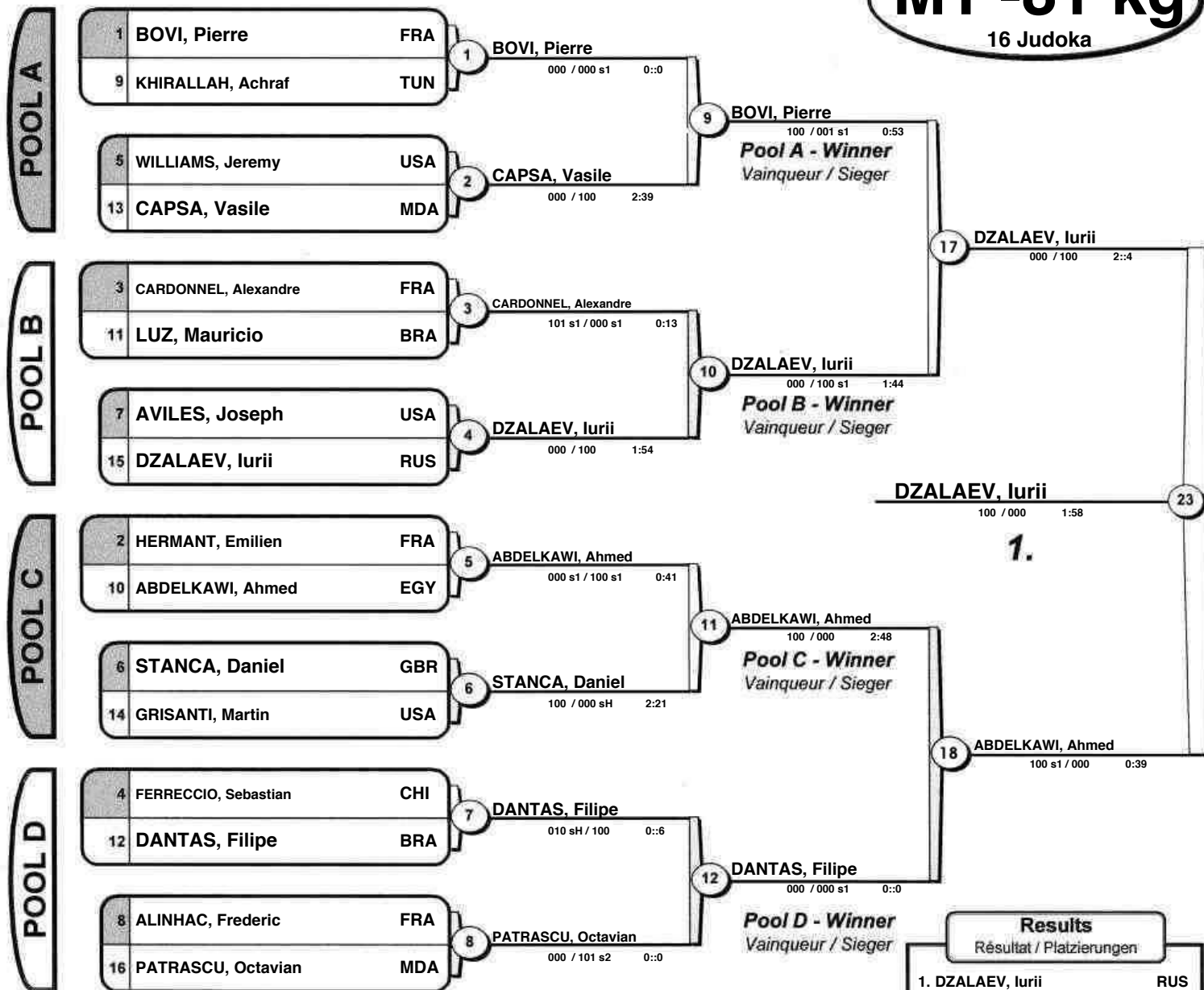



Veterans World Judo Championships 2016

(USA Fort Lauderdale, 18-21 November 2016)

M1 -90 kg

14 Judoka

POOL A

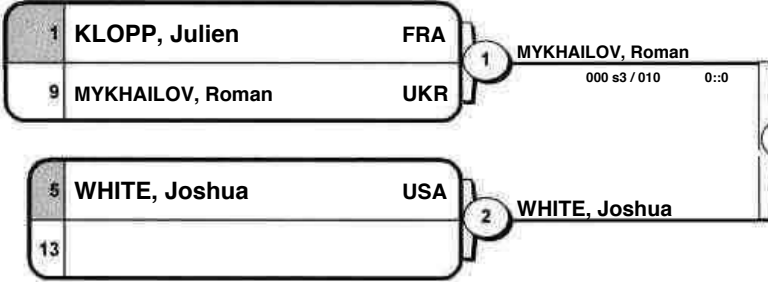

POOL B

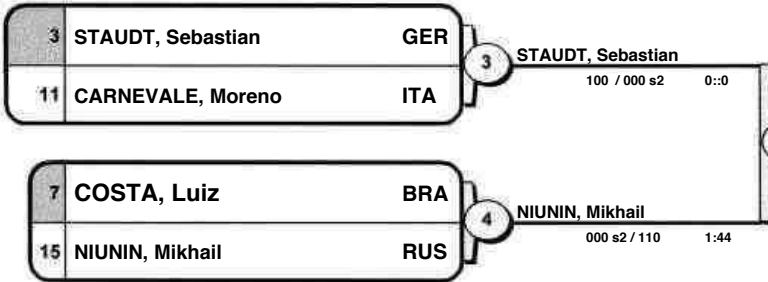

POOL C

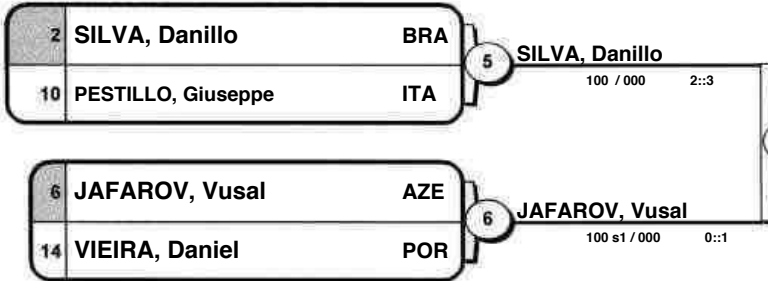

POOL D

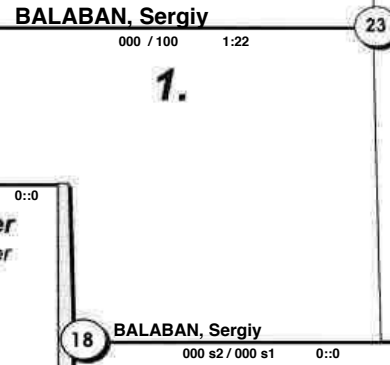
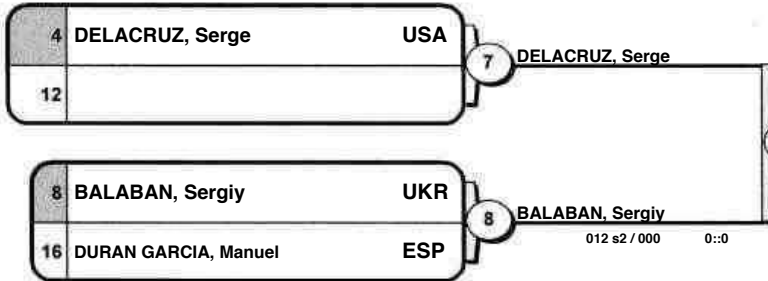

Results	
Résultat / Platzierungen	
1. BALABAN, Sergiy	UKR
2. MYKHAILOV, Roman	UKR
3. SILVA, Danilo	BRA
3. NIUNIN, Mikhail	RUS
5. KLOPP, Julien	FRA
5. DURAN GARCIA, Manuel	ESP
7. STAUDT, Sebastian	GER
7. PESTILLO, Giuseppe	ITA

Repechage / Trostrunde

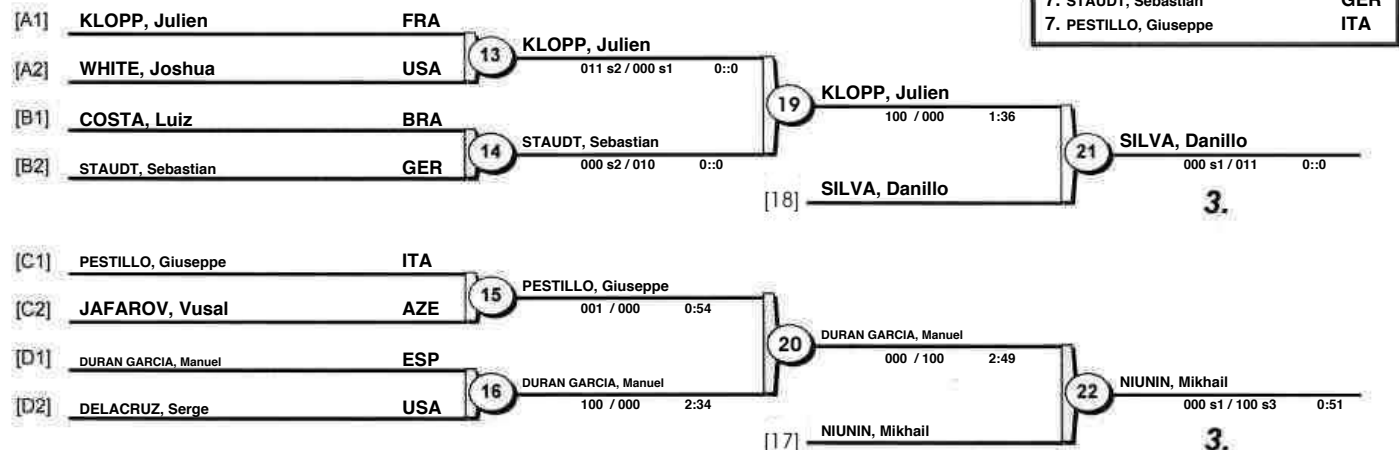



Veterans World Judo Championships 2016

(USA Fort Lauderdale, 18-21 November 2016)

M1 -100 kg

15 Judoka

POOL A

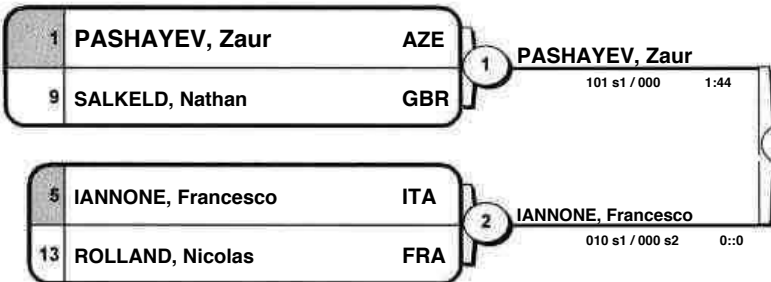

POOL B

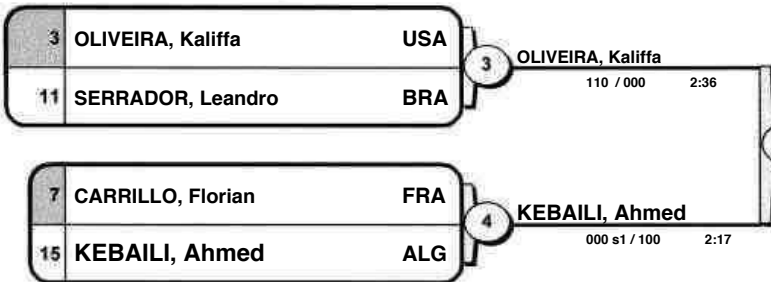

POOL C

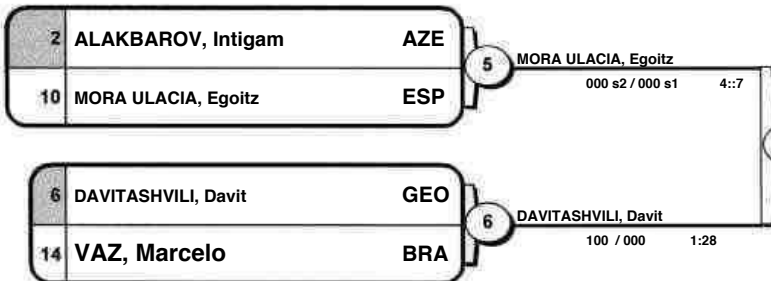

POOL D

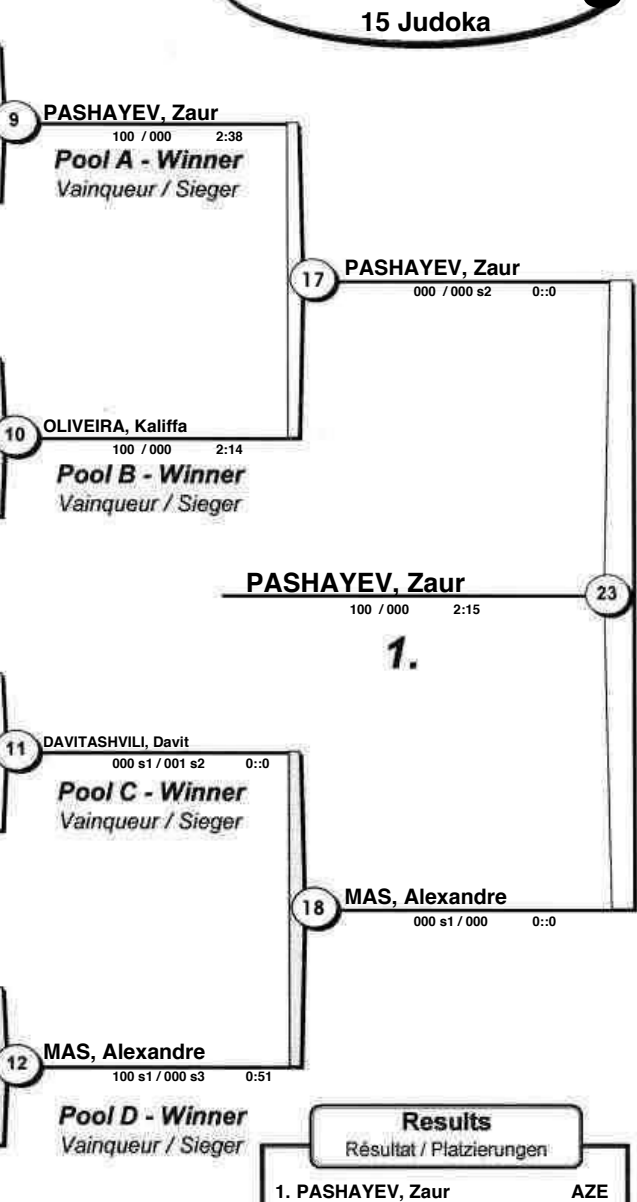
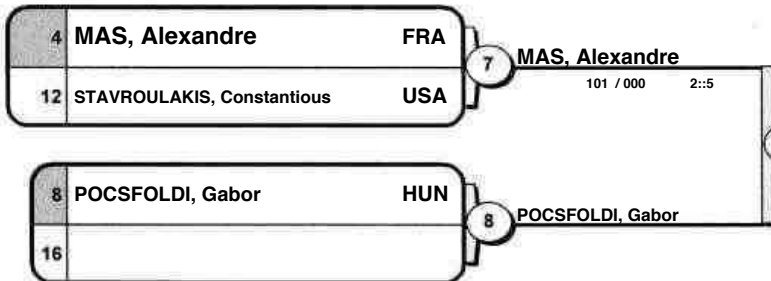

Results	
Résultat / Platzierungen	
1.	PASHAYEV, Zaur AZE
2.	MAS, Alexandre FRA
3.	KEBAILI, Ahmed ALG
3.	OLIVEIRA, Kaliffa USA
5.	DAVITASHVILI, Davit GEO
5.	MORA ULACIA, Egoitz ESP
7.	IANNONE, Francesco ITA
7.	POCSFOLDI, Gabor HUN

Repechage / Trostrunde

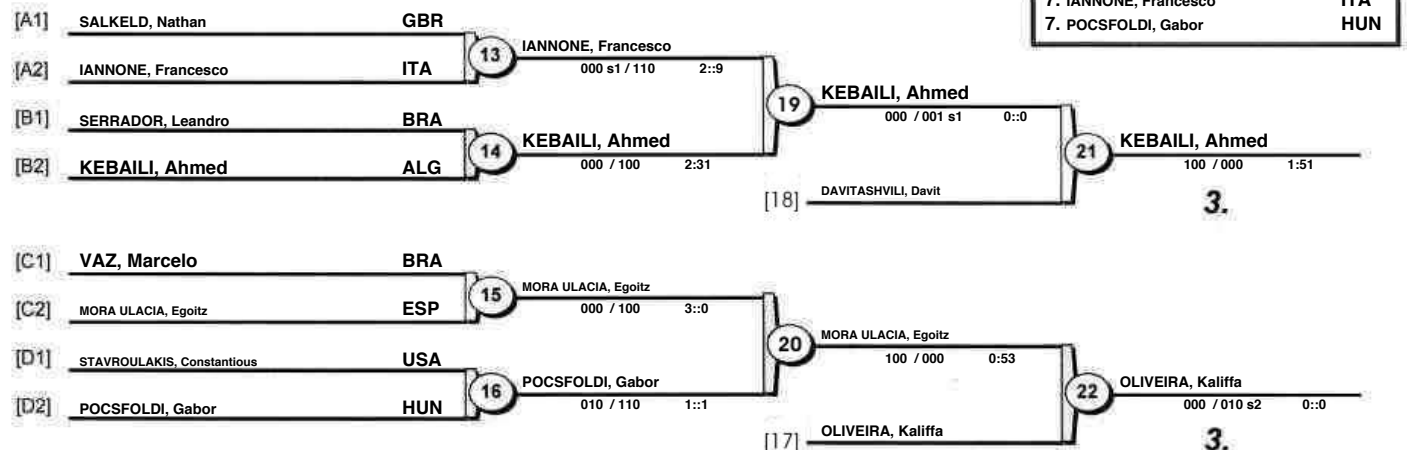



Veterans World Judo Championships 2016

(USA Fort Lauderdale, 18-21 November 2016)

M1 +100 kg

8 Judoka

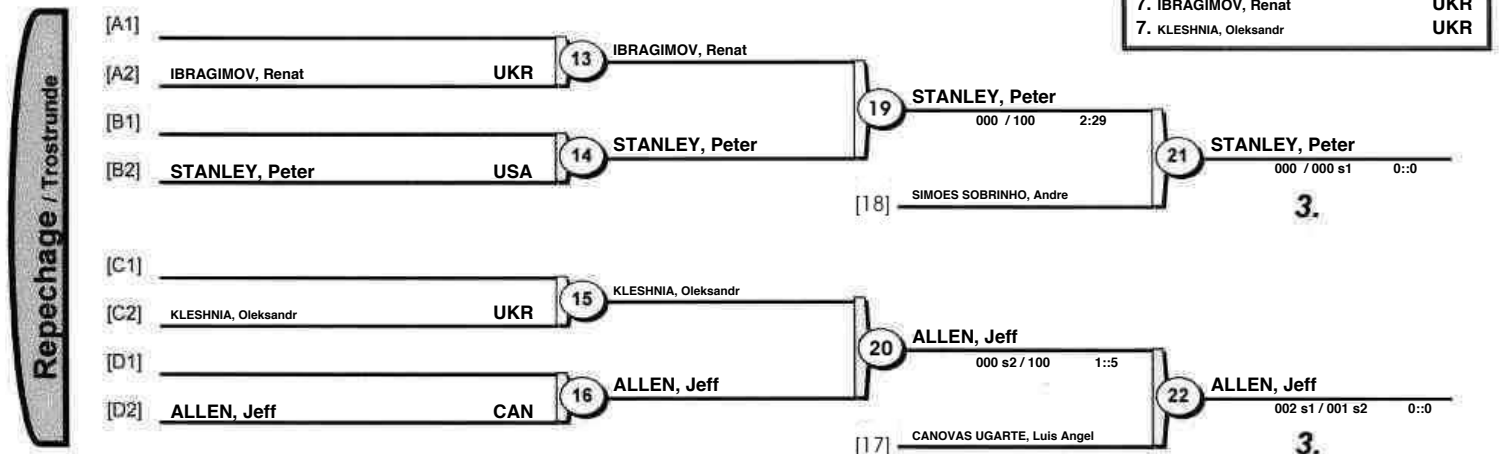
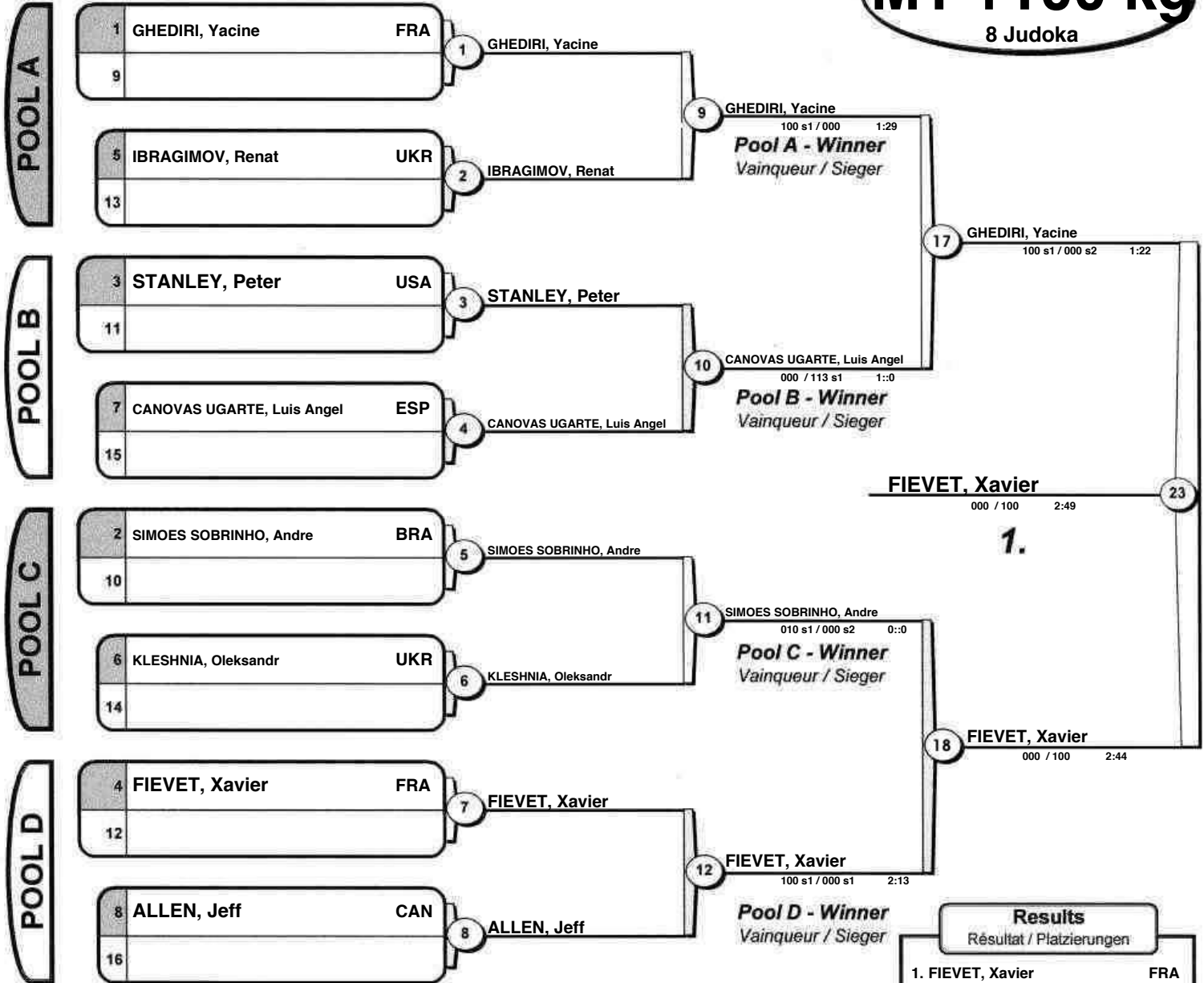



Veterans World Judo Championships 2016

(USA Fort Lauderdale, 18-21 November 2016)

M2 -60 kg

6 Judoka

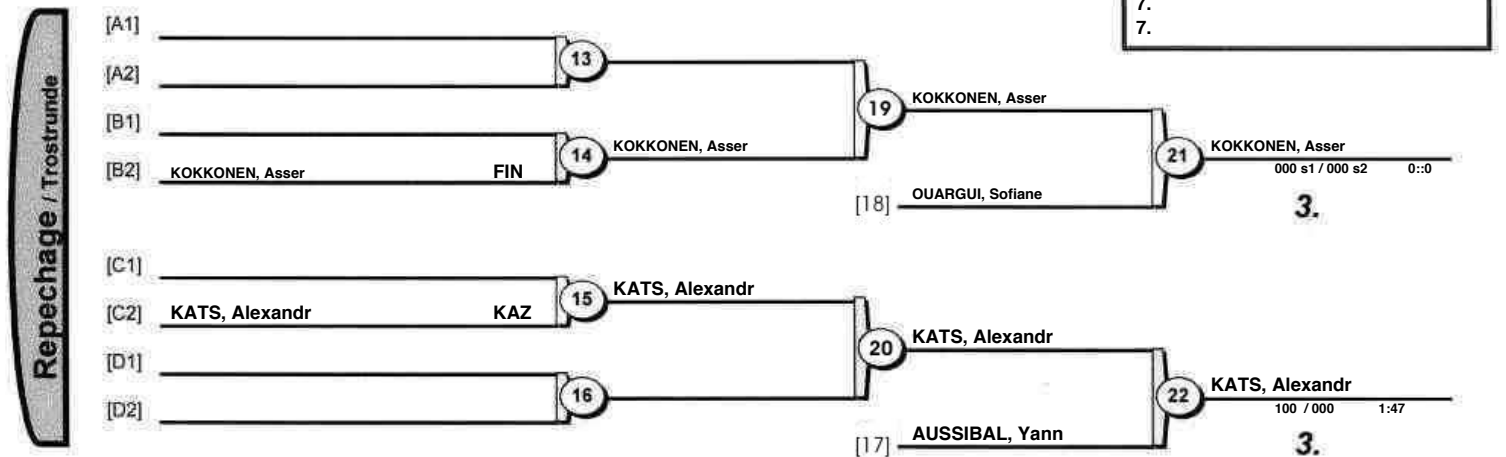
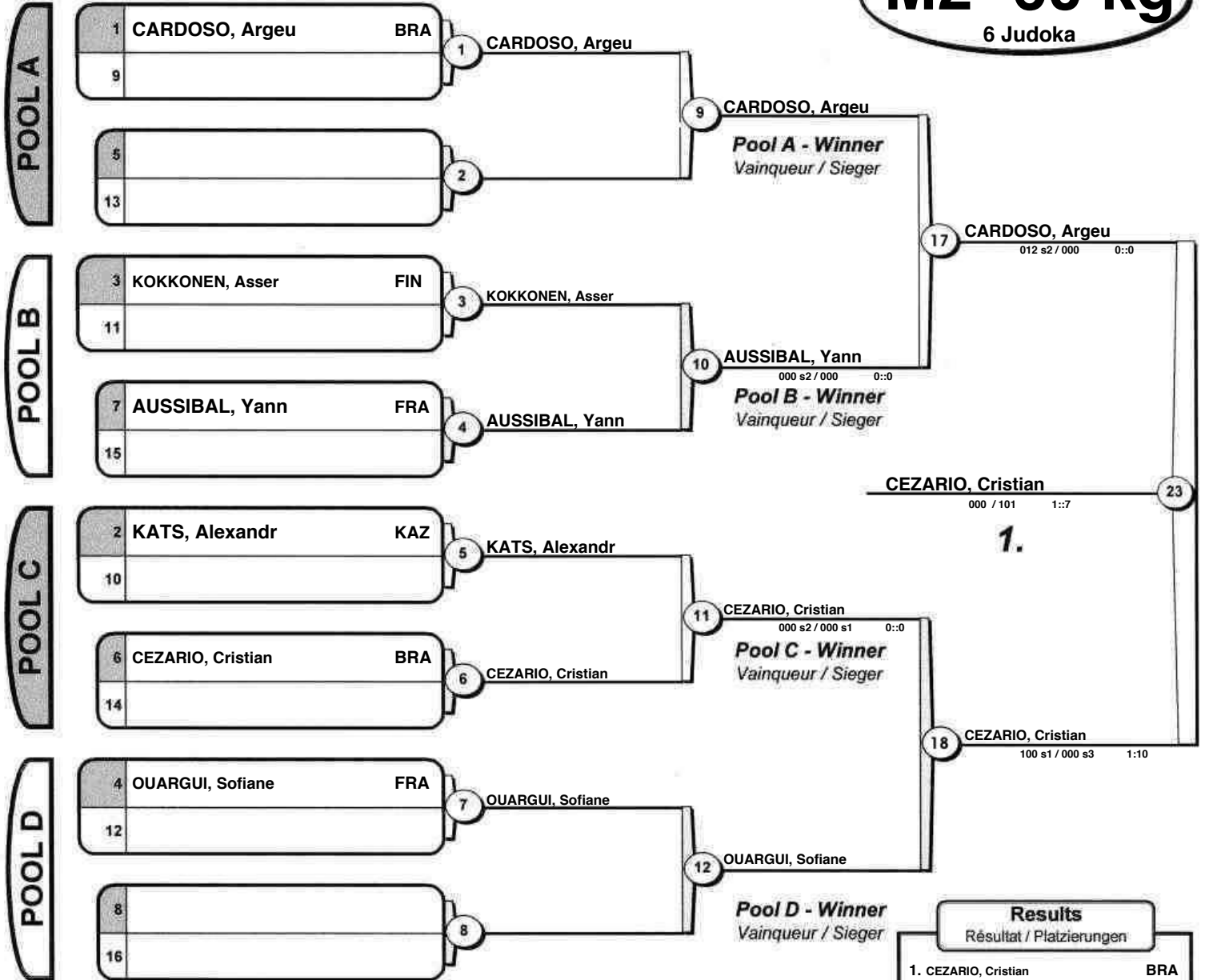



Veterans World Judo Championships 2016

(USA Fort Lauderdale, 18-21 November 2016)

M2 -66 kg

18 Judoka

POOL A

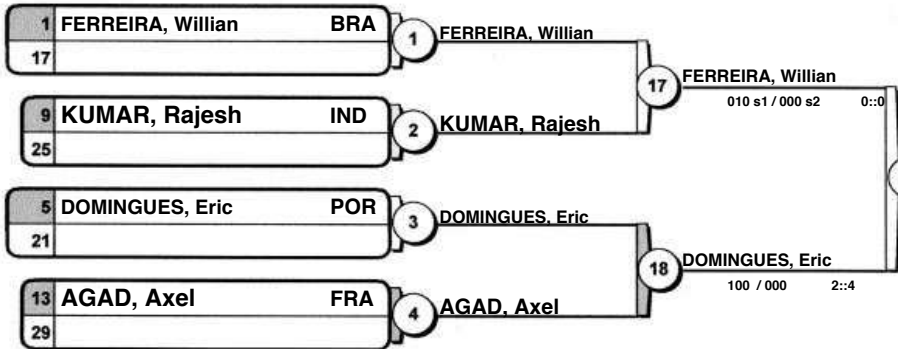

Pool A - Winner
Vainqueur / Sieger

POOL B

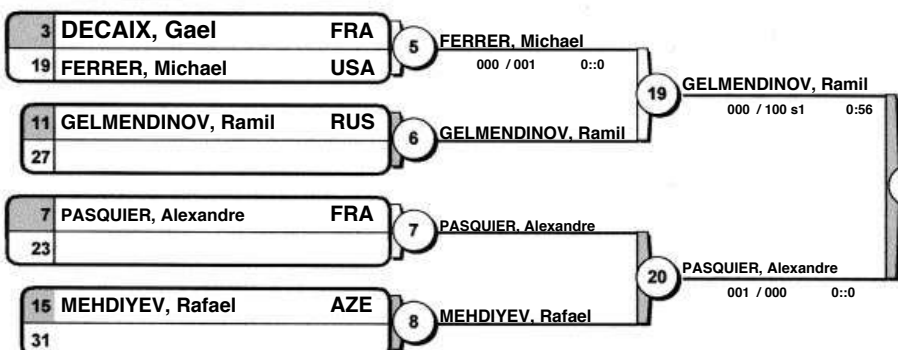

Pool B - Winner
Vainqueur / Sieger

POOL C

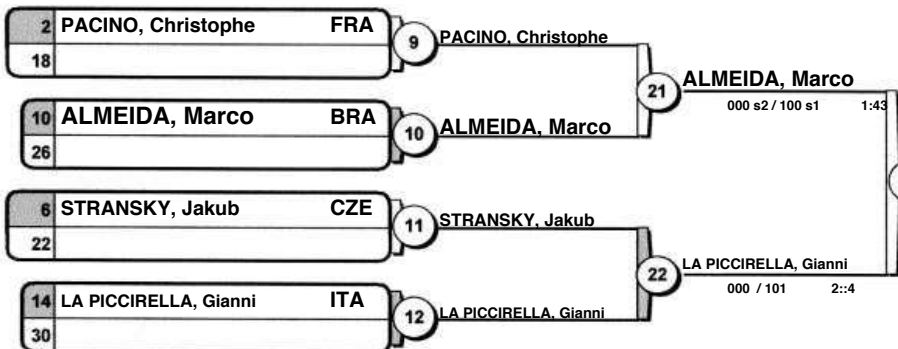

Pool C - Winner
Vainqueur / Sieger

POOL D

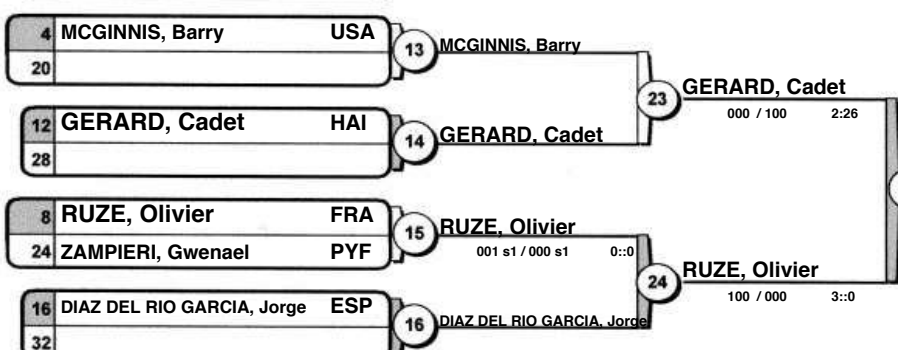

Pool D - Winner
Vainqueur / Sieger



1.

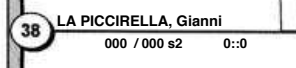

2.

Results	
Résultat / Platzierungen	
1.	PASQUIER, Alexandre FRA
2.	LA PICCIRELLA, Gianni ITA
3.	GELMENDINOV, Ramil RUS
3.	DOMINGUES, Eric POR
5.	RUZE, Olivier FRA
5.	GERARD, Cadet HAI
7.	AGAD, Axel FRA
7.	ALMEIDA, Marco BRA

Repechage / Trostrunde

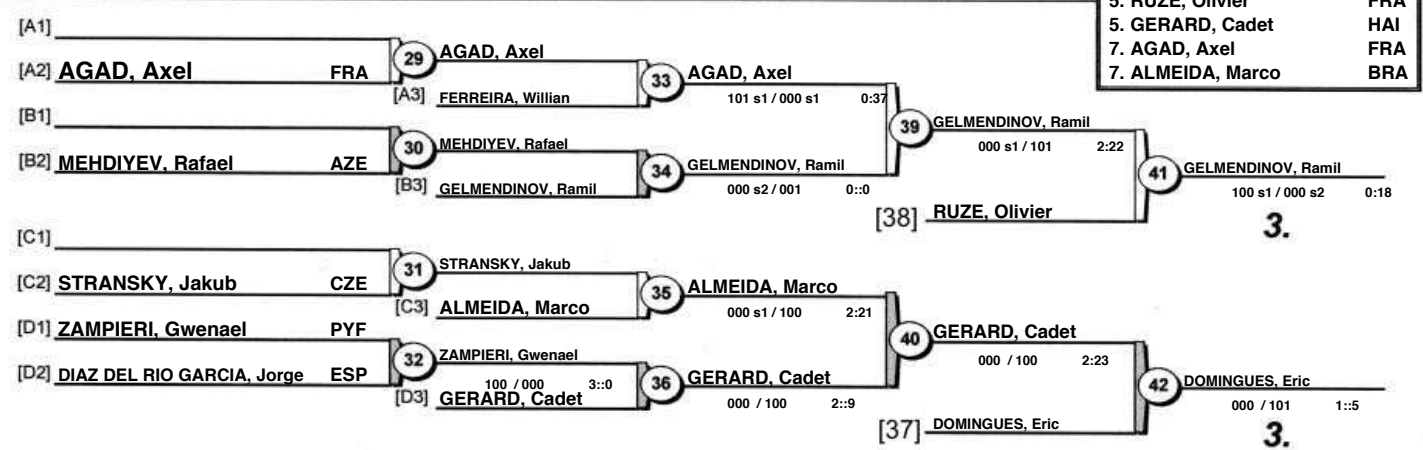

3.

3.



Veterans World Judo Championships 2016

(USA Fort Lauderdale, 18-21 November 2016)

M2 -73 kg

24 Judoka

POOL A



POOL B

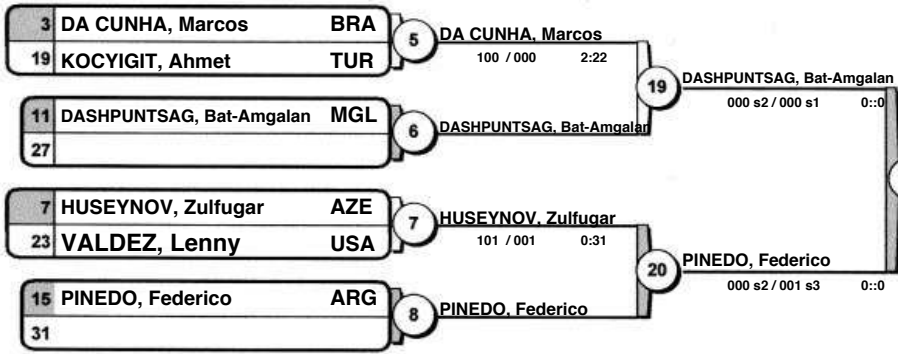

POOL C

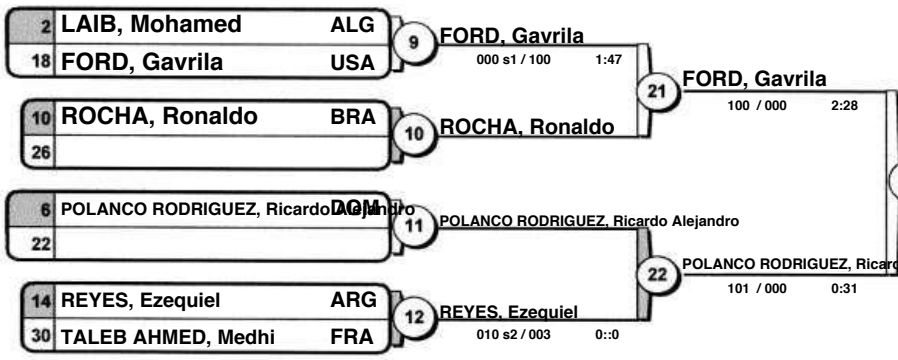

POOL D

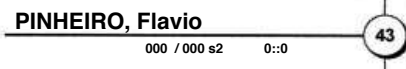

43 **1.**

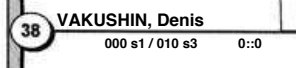

38 **3.**

Results	
Résultat / Platzierungen	
1.	PINHEIRO, Flavio BRA
2.	VAKUSHIN, Denis RUS
3.	FORD, Gavrila USA
3.	PINEDO, Federico ARG
5.	HUSEYNOV, Zulfugar AZE
5.	ROCHA, Ronaldo BRA
7.	RUSSO, Eduardo BRA
7.	DOS SANTOS, Geraldo BRA

Repechage / Trostrunde

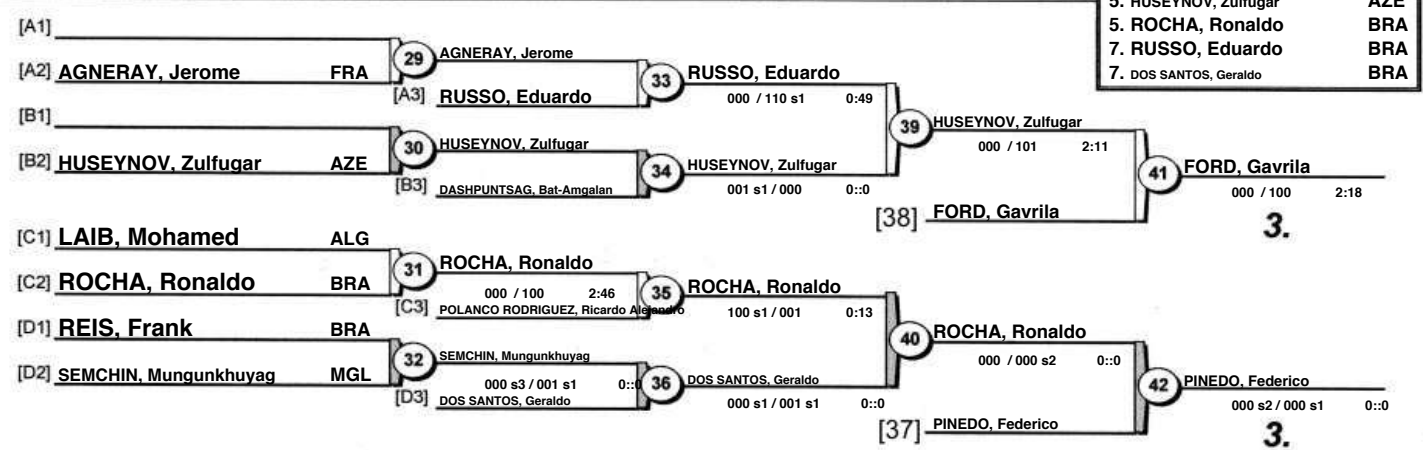

3.



Veterans World Judo Championships 2016

(USA Fort Lauderdale, 18-21 November 2016)

M2 -81 kg

25 Judoka

POOL A

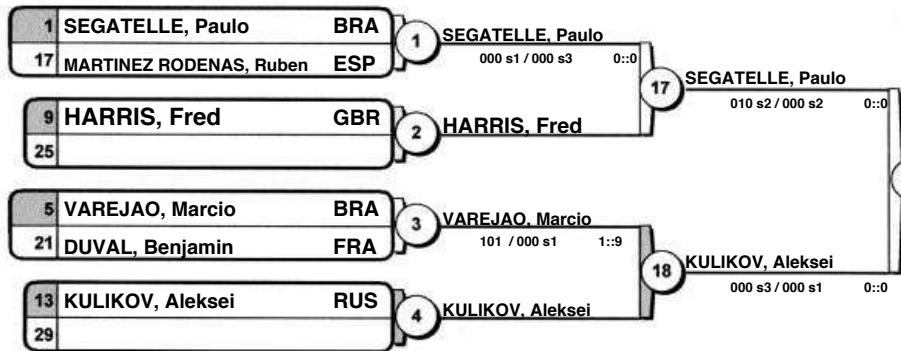

POOL B

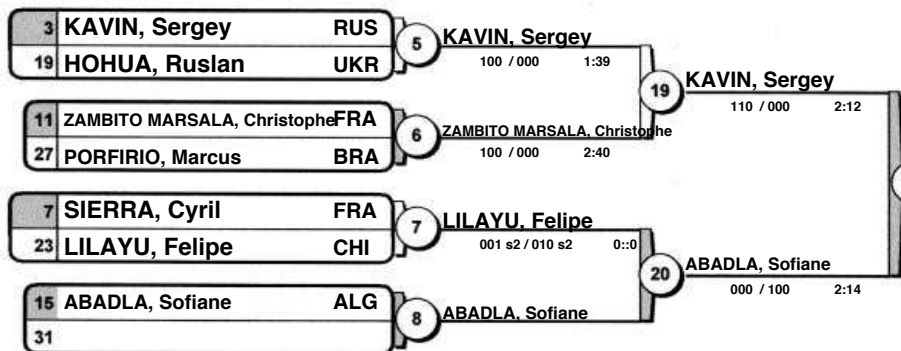

POOL C



POOL D

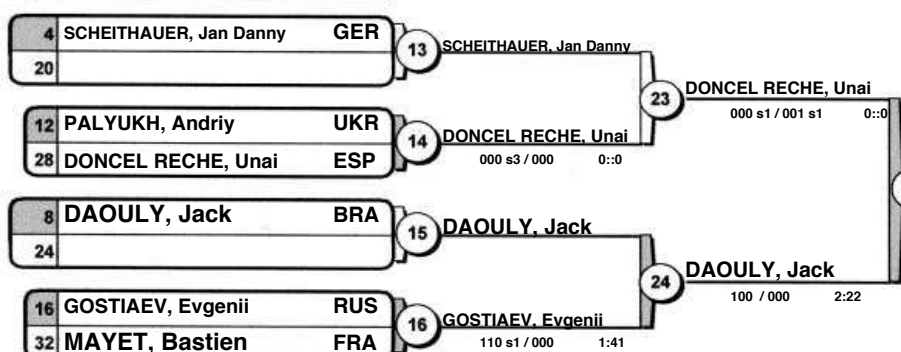

DAOULY, Jack 000 s3 / 000 s1 0:0

1.

DAOULY, Jack 000 / 100 2:41

Results Résultat / Platzierungen

1. DAOULY, Jack BRA
2. SEGATELLE, Paulo BRA
3. ABADLA, Sofiane ALG
3. ANIKIN, Nikolay RUS
5. ALSINA, Emmanuel ARG
5. KAVIN, Sergey RUS
7. KULIKOV, Aleksei RUS
7. GOSTIAEV, Evgenii RUS

Repechage / Trostrunde

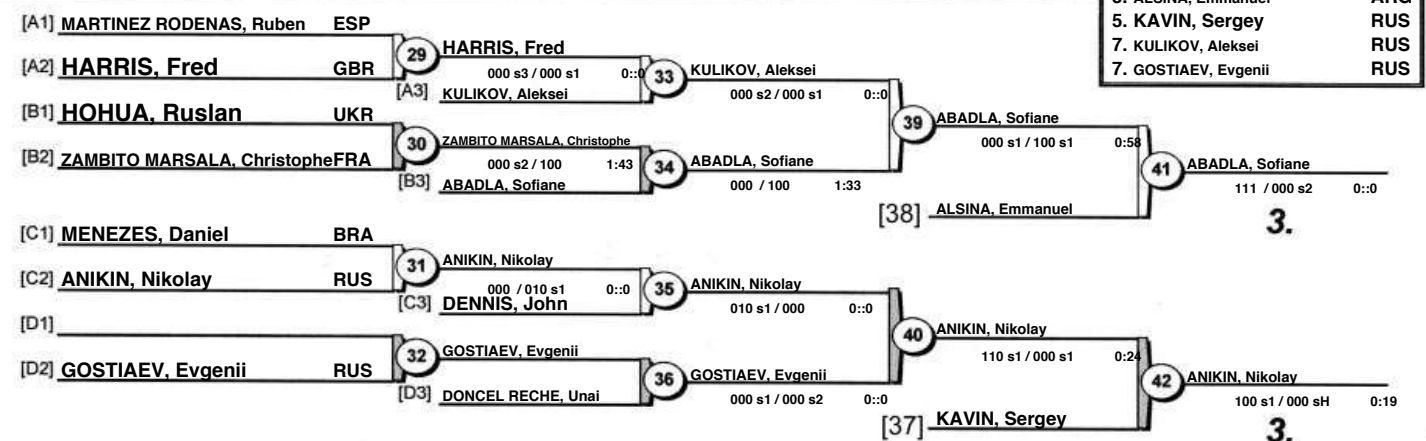

3.

3.



Veterans World Judo Championships 2016

(USA Fort Lauderdale, 18-21 November 2016)

M2 -90 kg

20 Judoka

POOL A

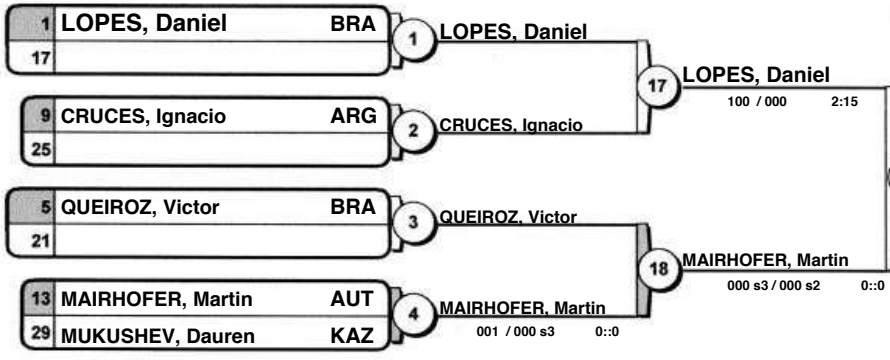

Pool A - Winner
Vainqueur / Sieger

POOL B

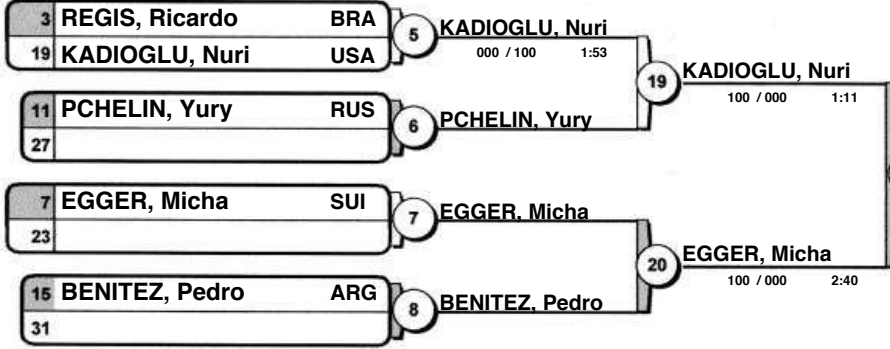

Pool B - Winner
Vainqueur / Sieger

POOL C

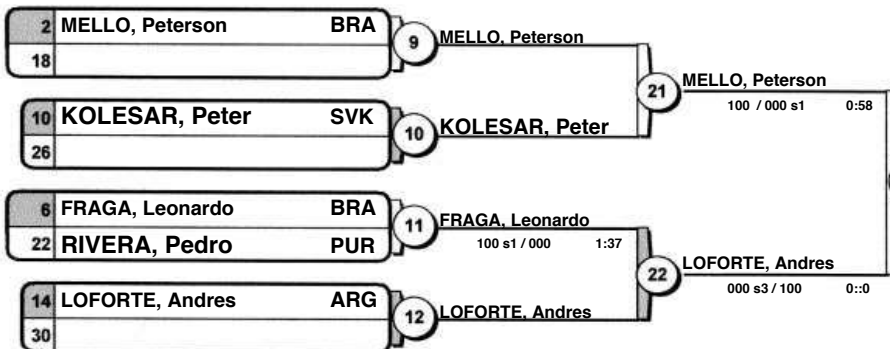

Pool C - Winner
Vainqueur / Sieger

POOL D



Pool D - Winner
Vainqueur / Sieger



1.

Results		
Résultat / Platzierungen		
1.	EGGER, Micha	SUI
2.	LOFORTE, Andres	ARG
3.	ALONSO, Humberto	BRA
3.	MAIRHOFER, Martin	AUT
5.	LOPES, Daniel	BRA
5.	MELLO, Peterson	BRA
7.	KADIOGLU, Nuri	USA
7.	LOPEZ POLO, Juan Alberto	ESP

Repechage / Trostrunde

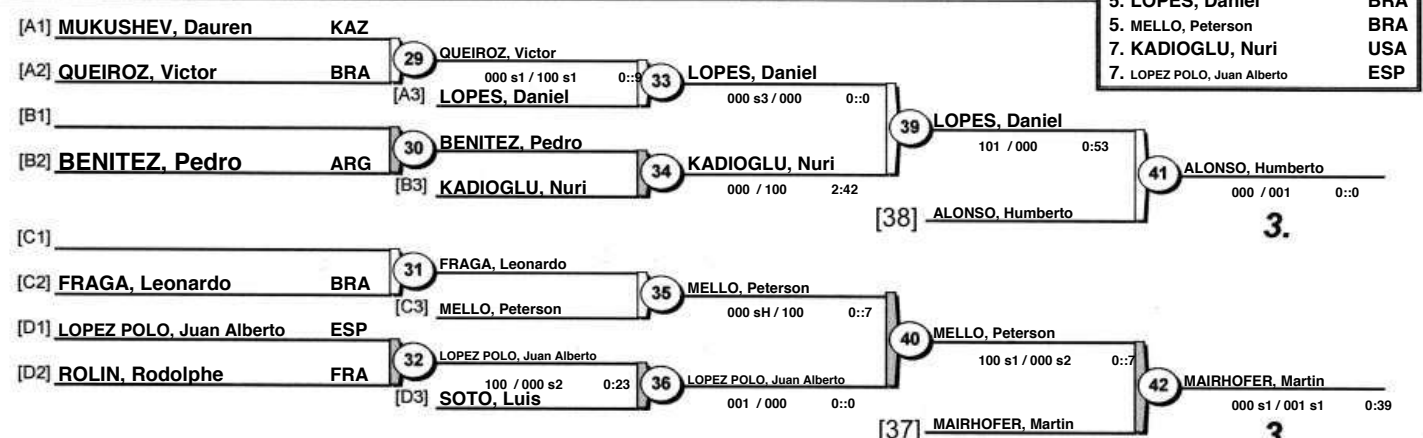

3.



Veterans World Judo Championships 2016

(USA Fort Lauderdale, 18-21 November 2016)

M2 -100 kg

21 Judoka

POOL A

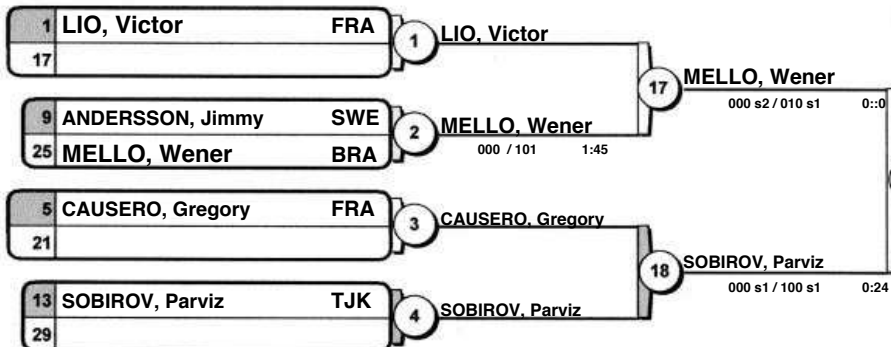

POOL B

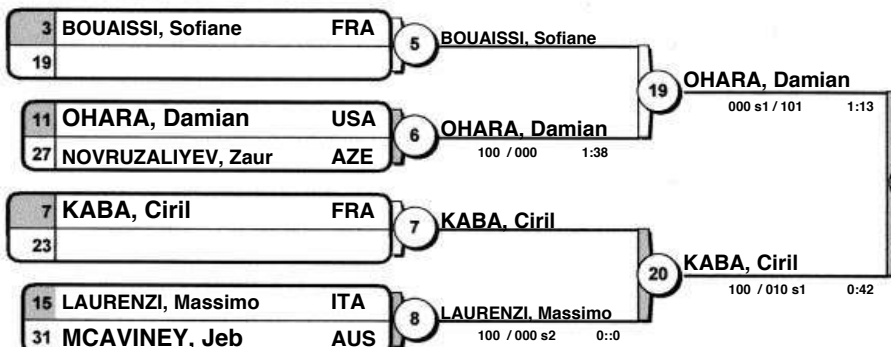

POOL C

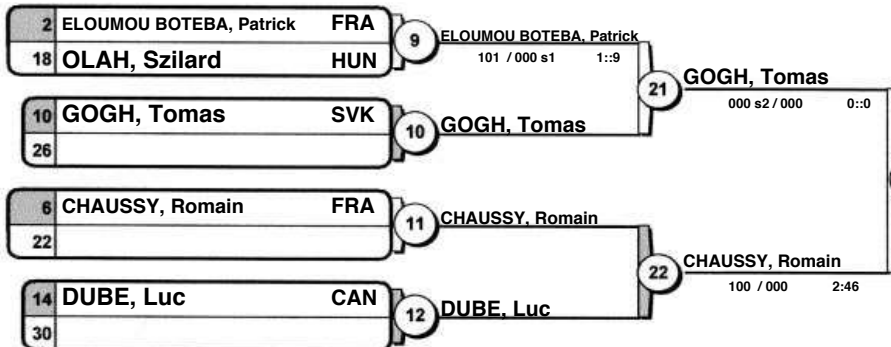

POOL D

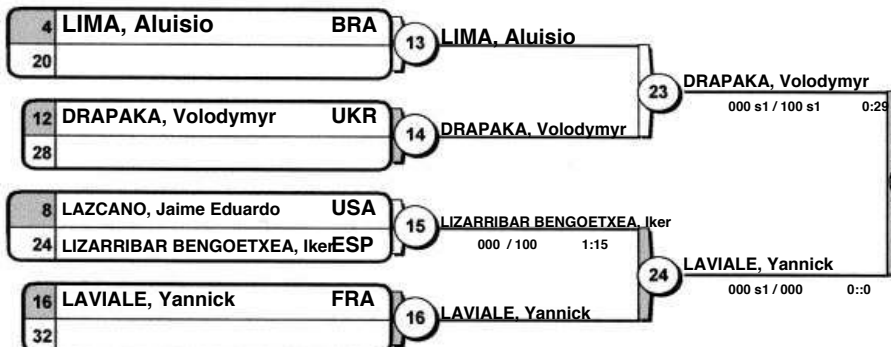

1.

Pool C - Winner
Vainqueur / Sieger

Pool D - Winner
Vainqueur / Sieger

Results Résultat / Platzierungen

1. SOBIROV, Parviz TJK
2. LAVIALE, Yannick FRA
3. KABA, Ciril FRA
3. GOGH, Tomas SVK
5. CHAUSSY, Romain FRA
5. OHARA, Damian USA
7. CAUSERO, Gregory FRA
7. DRAPAKA, Volodymyr UKR

Repechage / Trostrunde

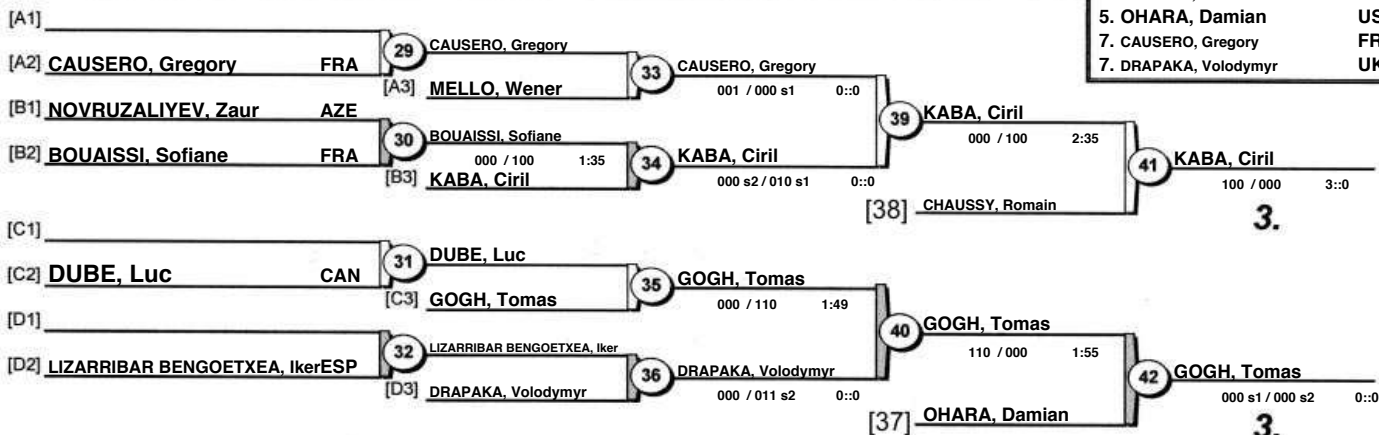

3.

3.



Veterans World Judo Championships 2016

(USA Fort Lauderdale, 18-21 November 2016)

M2 +100 kg

9 Judoka

POOL A

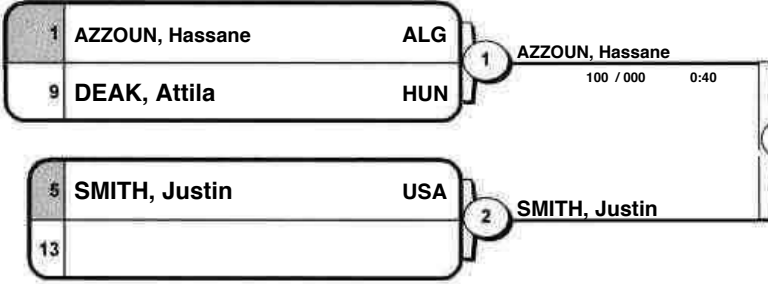

POOL B

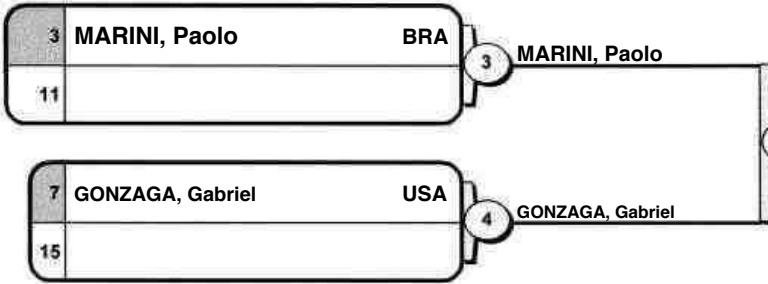

POOL C

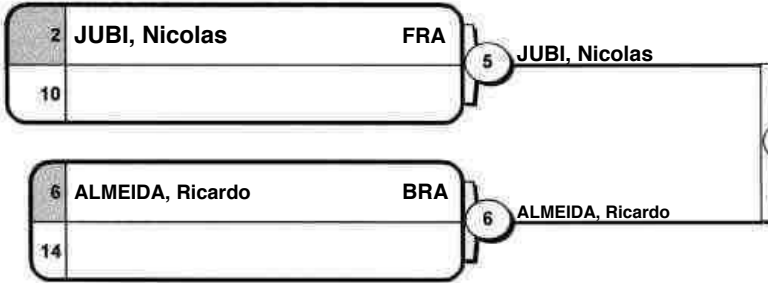

POOL D

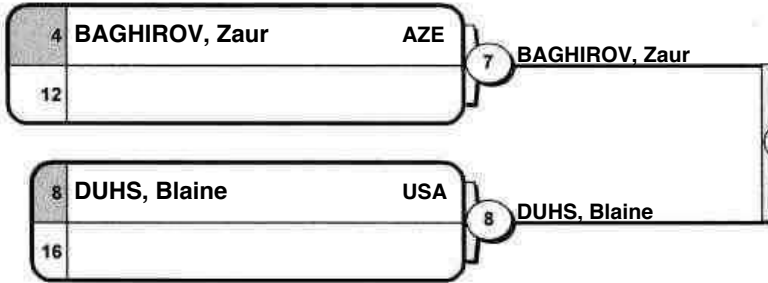

1.

Results

Résultat / Platzierungen

1.	AZZOUN, Hassane	ALG
2.	BAGHIROV, Zaur	AZE
3.	ALMEIDA, Ricardo	BRA
3.	GONZAGA, Gabriel	USA
5.	DEAK, Attila	HUN
5.	DUHS, Blaine	USA
7.	MARINI, Paolo	BRA
7.	JUBI, Nicolas	FRA

Repechage / Trostrunde

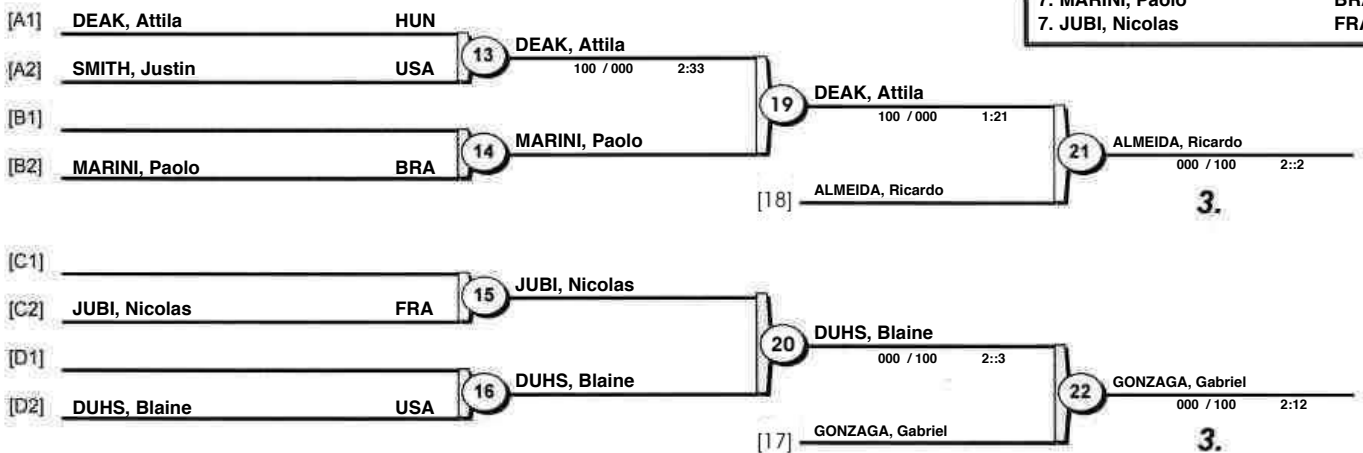



Veterans World Judo Championships 2016

(USA Fort Lauderdale, 18-21 November 2016)

M3 -60 kg

5 Judoka

			1	2	3	4	5		
1	DANG, Ryan	USA		0	0	1 (0.5)	1 (100)	2 (100.5)	
2	ANDREI, Marco	ITA	1 (0.5)		0	1 (100)	1 (100)	3 (200.5)	
3	GOUGOUZIAN, David	FRA	1 (100)	1 (100)		1 (100)	1 (0.5)	4 (300.5)	
4	LANIBA, Salomon	FRA	0	0	0		1 (100)	1 (100)	
5	EKENBERG, Mikael	SWE	0	0	0	0		(0)	

1	DANG, Ryan	USA	1	ANDREI, Marco	ITA
2	ANDREI, Marco	ITA		000 s2 / 000 s1	0::0

3	GOUGOUZIAN, David	FRA	2	GOUGOUZIAN, David	FRA
4	LANIBA, Salomon	FRA		100 / 000	2:42

1	DANG, Ryan	USA	3	DANG, Ryan	USA
5	EKENBERG, Mikael	SWE		100 / 000 s2	0:43

2	ANDREI, Marco	ITA	4	GOUGOUZIAN, David	FRA
3	GOUGOUZIAN, David	FRA		000 / 100	2:10

4	LANIBA, Salomon	FRA	5	LANIBA, Salomon	FRA
5	EKENBERG, Mikael	SWE		100 / 000	2:40

1	DANG, Ryan	USA	6	GOUGOUZIAN, David	FRA
3	GOUGOUZIAN, David	FRA		000 s1 / 100 s3	0:51

2	ANDREI, Marco	ITA	7	ANDREI, Marco	ITA
4	LANIBA, Salomon	FRA		100 / 000	2:13

3	GOUGOUZIAN, David	FRA	8	GOUGOUZIAN, David	FRA
5	EKENBERG, Mikael	SWE		001 s1 / 001 s2	0::0

1	DANG, Ryan	USA	9	DANG, Ryan	USA
4	LANIBA, Salomon	FRA		000 / 000 s2	0::0

2	ANDREI, Marco	ITA	10	ANDREI, Marco	ITA
5	EKENBERG, Mikael	SWE		100 / 000 s1	0:38

Final Results

- GOUGOUZIAN, David FRA
- ANDREI, Marco ITA
- DANG, Ryan USA
-



Veterans World Judo Championships 2016

(USA Fort Lauderdale, 18-21 November 2016)

M3 -66 kg

18 Judoka

POOL A

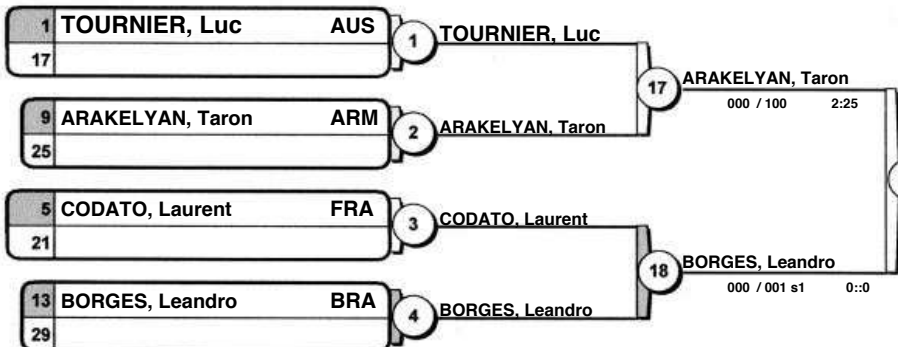

POOL B



POOL C

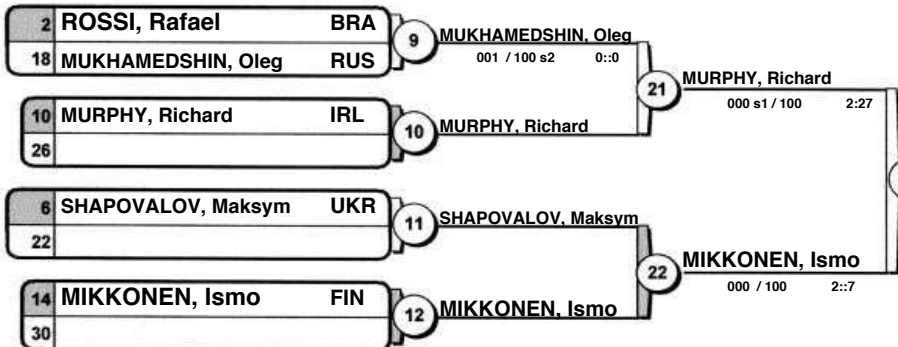

POOL D

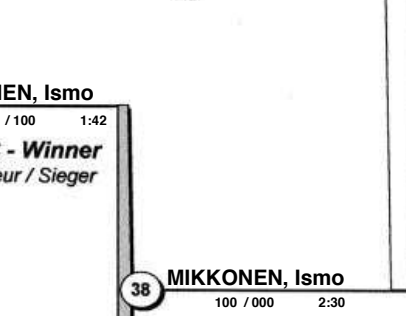

Results Résultat / Platzierungen

1. MIKKONEN, Ismo FIN
2. DIAS, Vlamir BRA
3. BROCCHERI, Fabio Stefano ITA
3. SHAPOVALOV, Maksym UKR
5. ROUIBET, Abdelkrim ALG
5. BORGES, Leandro BRA
7. ARAKELIAN, Taron ARM
7. NAKAYAMA, Takahisa JPN

Repechage / Trostrunde

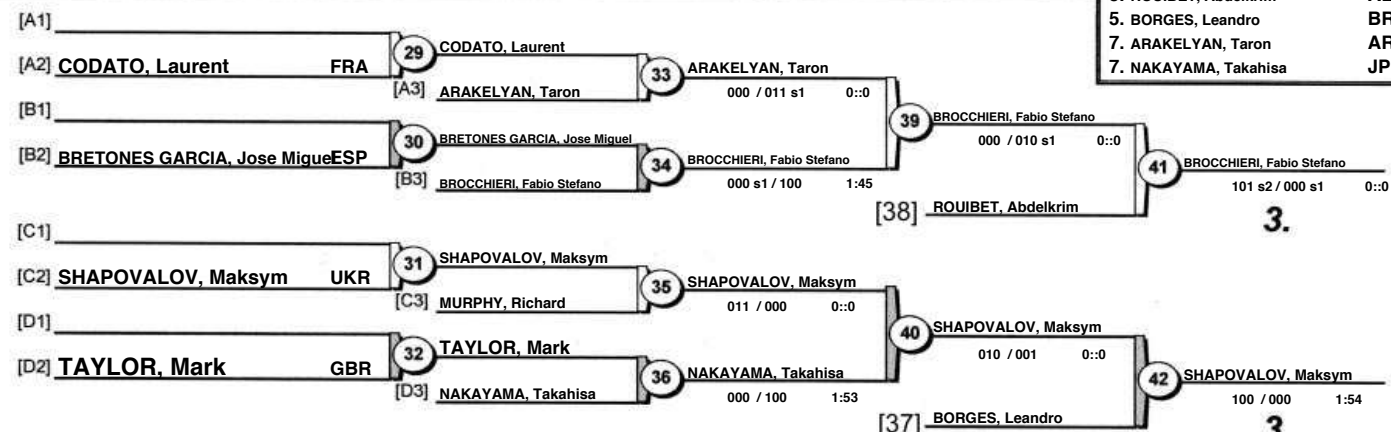



Veterans World Judo Championships 2016

(USA Fort Lauderdale, 18-21 November 2016)

M3 -73 kg

28 Judoka

POOL A

1	RODRIGUES JUNIOR, Lucio	BRA	1	RODRIGUES JUNIOR, Lucio	010 s3 / 000 s1	0:0
17	LEPORE, Alessio	ITA	17	RODRIGUES JUNIOR, Lucio	100 / 000	2:10
9	KARMACHARYA, Rajesh	NEP	2	KAROLYI, Sandor	000 s2 / 100	1:26
25	KAROLYI, Sandor	HUN	25	HOMER, Craig	000 s1 / 100	0:1
5	LISAI, Patrick	FRA	3	LISAI, Patrick	000 / 100	2:30
21			18	HOMER, Craig	000 / 100	2:30
13	LEE, Hak Sul	KOR	4	HOMER, Craig	010 s1 / 100	0:23
29	HOMER, Craig	GBR	4	HOMER, Craig	010 s1 / 100	0:23

POOL B

3	LI, Denis	KAZ	5	LI, Denis	000 s1 / 100	1:23
19			19	GADZHIEV, Rafail	000 s1 / 100	1:23
11	GADZHIEV, Rafail	RUS	6	GADZHIEV, Rafail	101 / 000 s1	1:57
27	BERNARDINO, Gustavo	BRA	26	GADZHIEV, Rafail	100 / 000 s1	0:39
7	ZEMPLINSKY, Tony	USA	7	ZEMPLINSKY, Tony	100 / 000	2:16
23	BIGOT, Christophe	FRA	20	MATSUNAGA MATSUNAGA, Norio	000 / 110	1:2
15	MATSUNAGA MATSUNAGA, Norio	DOM	8	MATSUNAGA MATSUNAGA, Norio	100 s1 / 000	2:29
31	DIAZ VILA, Daniel	ESP	8	MATSUNAGA MATSUNAGA, Norio	100 s1 / 000	2:29

POOL C

2	ROCHA, Cesar	BRA	9	SINILOV, Sergii	000 s3 / 000	0:0
18	SINILOV, Sergii	UKR	21	MERENKOV, Valeriy	000 / 100	2:43
10	MERENKOV, Valeriy	RUS	10	MERENKOV, Valeriy	010 s1 / 000 s1	0:0
26	MIJALKOVIC, Marko	SRB	27	MERENKOV, Valeriy	100 s1 / 000 s1	0:18
6	HAYEK, Bahjet	BRA	11	HAYEK, Bahjet	101 / 000	1:22
22			22	HAYEK, Bahjet	101 / 000	1:22
14	MACAULAY, Alan Brian	GBR	12	MACAULAY, Alan Brian	101 / 000	1:12
30	MELICIANO, Patrice	FRA	12	MACAULAY, Alan Brian	101 / 000	1:12

POOL D

4	KLCSO, Gabor	HUN	13	CAVES, Erin	000 s1 / 010 s1	0:0
20	CAVES, Erin	USA	23	ALAMOV, Alisher	000 s2 / 010 s2	0:0
12	ALAMOV, Alisher	TJK	14	ALAMOV, Alisher	100 / 000	2:42
28	LEOCADIO, Alexandre	BRA	28	ESPIRITUSANTO DE MIGUEL, Santiago	000 s2 / 100	0:0
8	ESPIRITUSANTO DE MIGUEL, Santiago	ESP	15	ESPIRITUSANTO DE MIGUEL, Santiago	101 s1 / 000	0:24
24			24	ESPIRITUSANTO DE MIGUEL, Santiago	101 s1 / 000	0:24
16	HILBIG, Dirk	GER	16	PERREAUX, Jerome	000 s1 / 010 s1	0:0
32	PERREAUX, Jerome	FRA	16	PERREAUX, Jerome	000 s1 / 010 s1	0:0

37	HOMER, Craig	000 s1 / 000 s3	0:0
43	MERENKOV, Valeriy	000 s1 / 100	0:52
1.			
38	MERENKOV, Valeriy	100 / 000	2:2

Results	
Résultat / Platzierungen	
1.	MERENKOV, Valeriy RUS
2.	HOMER, Craig GBR
3.	ESPIRITUSANTO DE MIGUEL, Santiago ESP
3.	MIJALKOVIC, Marko SRB
5.	RODRIGUES JUNIOR, Lucio BRA
5.	GADZHIEV, Rafail RUS
7.	MATSUNAGA MATSUNAGA, Norio DOM
7.	ALAMOV, Alisher TJK

Repechage / Trostrunde

[A1]	LEE, Hak Sul	KOR	29	LEE, Hak Sul	000 / 000 s1	0:0	33	RODRIGUES JUNIOR, Lucio	000 s2 / 100	0:10
[A2]	LISAI, Patrick	FRA	[A3]	RODRIGUES JUNIOR, Lucio			39	RODRIGUES JUNIOR, Lucio	001 s2 / 000	0:0
[B1]	BERNARDINO, Gustavo	BRA	30	LI, Denis	000 / 100	3:0	34	MATSUNAGA MATSUNAGA, Norio	000 s1 / 000	0:0
[B2]	LI, Denis	KAZ	[B3]	MATSUNAGA MATSUNAGA, Norio			[38]	ESPIRITUSANTO DE MIGUEL, Santiago		
[C1]	MIJALKOVIC, Marko	SRB	31	MIJALKOVIC, Marko	100 s1 / 000 s1	0:49	35	MIJALKOVIC, Marko	000 s1 / 000 s2	0:0
[C2]	SINILOV, Sergii	UKR	[C3]	HAYEK, Bahjet			40	MIJALKOVIC, Marko	100 s1 / 000 s3	0:5
[D1]			32	PERREAUX, Jerome			42	MIJALKOVIC, Marko	000 s1 / 000 s2	0:0
[D2]	PERREAUX, Jerome	FRA	[D3]	ALAMOV, Alisher			[37]	GADZHIEV, Rafail		



Veterans World Judo Championships 2016

(USA Fort Lauderdale, 18-21 November 2016)

M3 -81 kg
34 Judoka

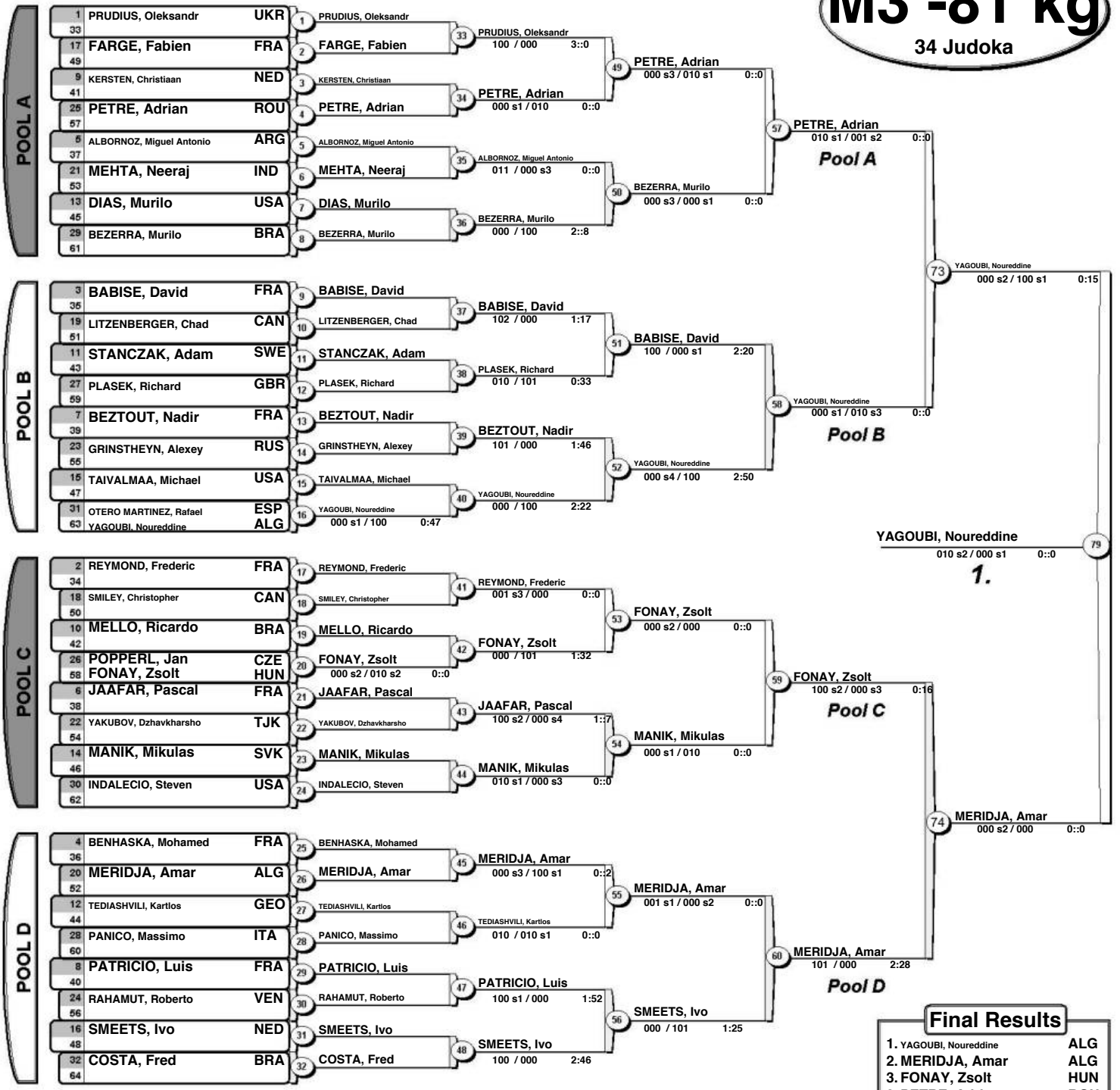

Repechage

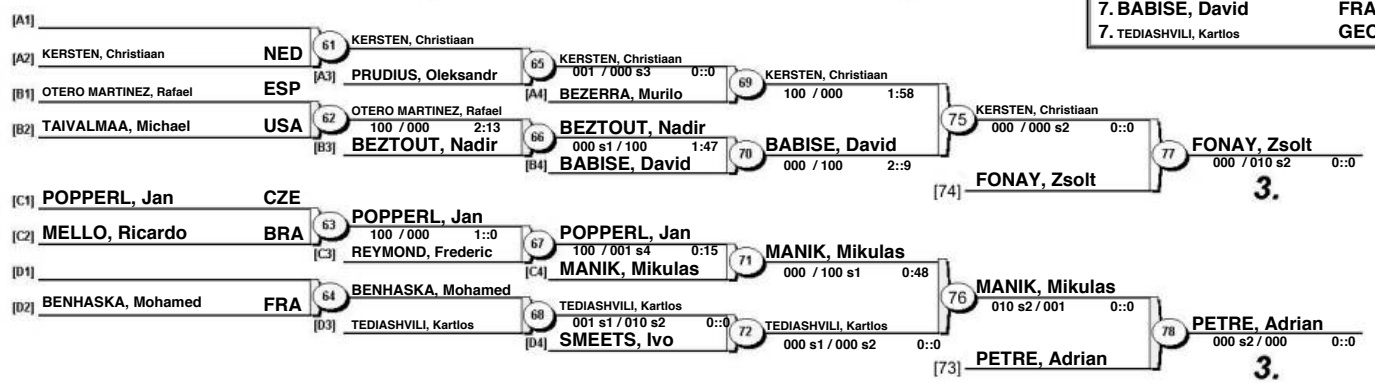



Veterans World Judo Championships 2016

(USA Fort Lauderdale, 18-21 November 2016)

M3 -90 kg

21 Judoka

POOL A

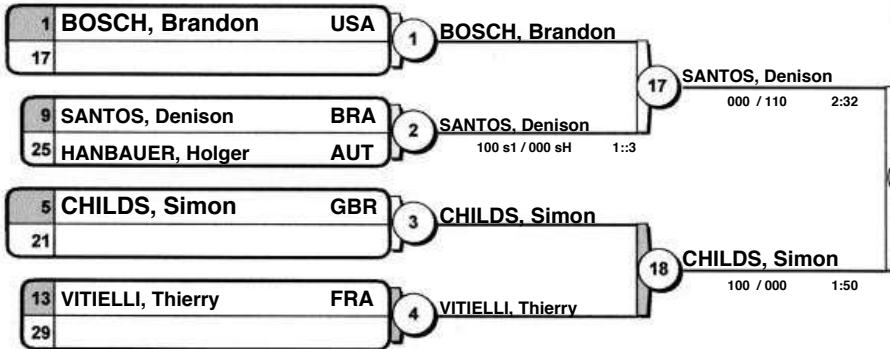

POOL B



POOL C

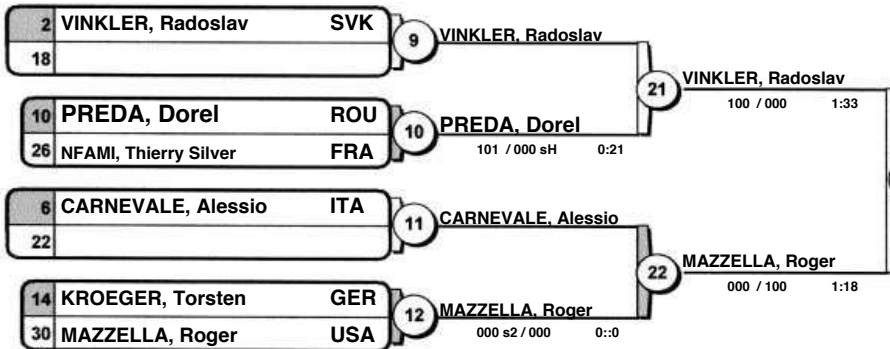

POOL D

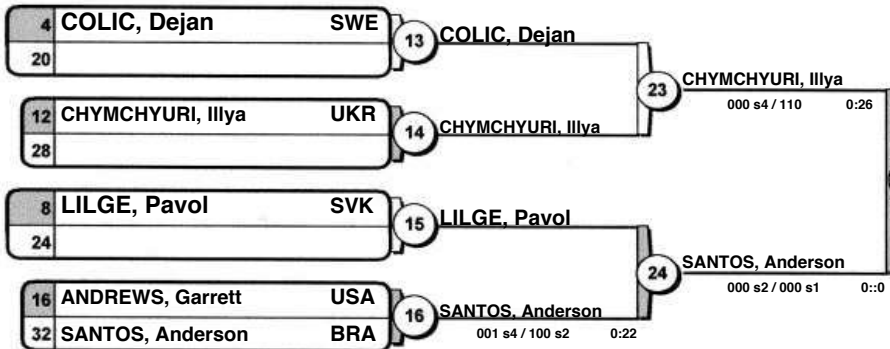

1.



Results	
Résultat / Platzierungen	
1.	CHYMCHYURI, Iliya UKR
2.	VIEIRA, Alexandre POR
3.	MAZZELLA, Roger USA
3.	SANTOS, Denison BRA
5.	HANBAUER, Holger AUT
5.	VINKLER, Radoslav SVK
7.	BIELAK, Martin SVK
7.	SANTOS, Anderson BRA

Repechage / Trostrunde

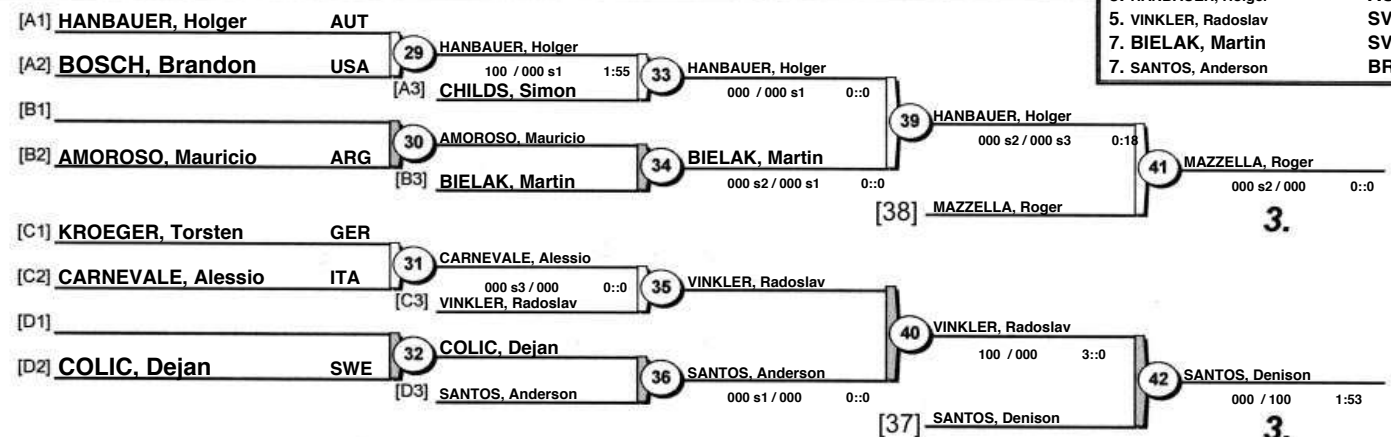



Veterans World Judo Championships 2016

(USA Fort Lauderdale, 18-21 November 2016)

M3 -100 kg

27 Judoka

POOL A

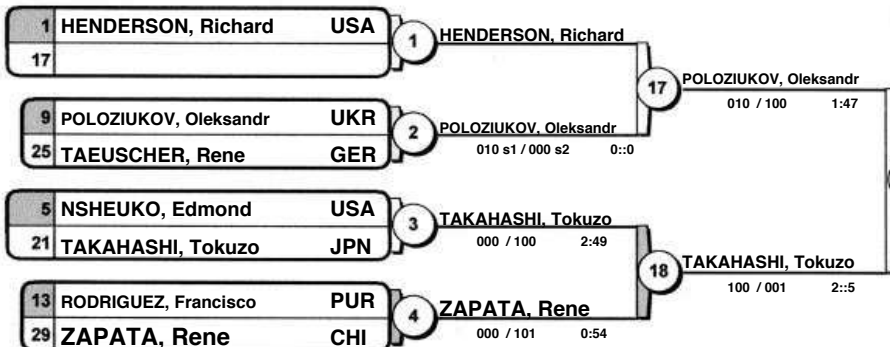

Pool A - Winner
Vainqueur / Sieger

POOL B

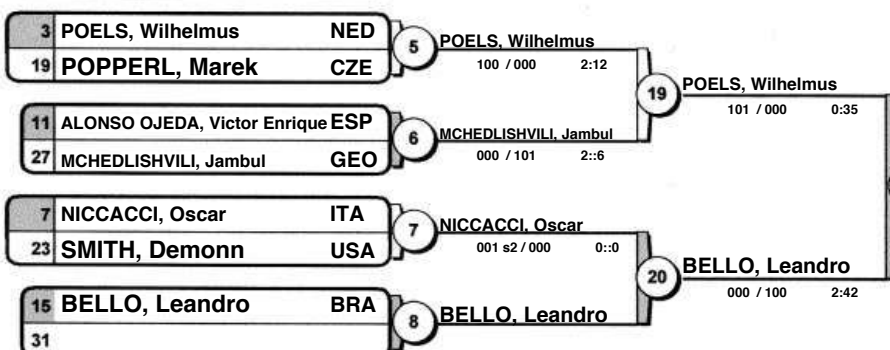

Pool B - Winner
Vainqueur / Sieger

POOL C

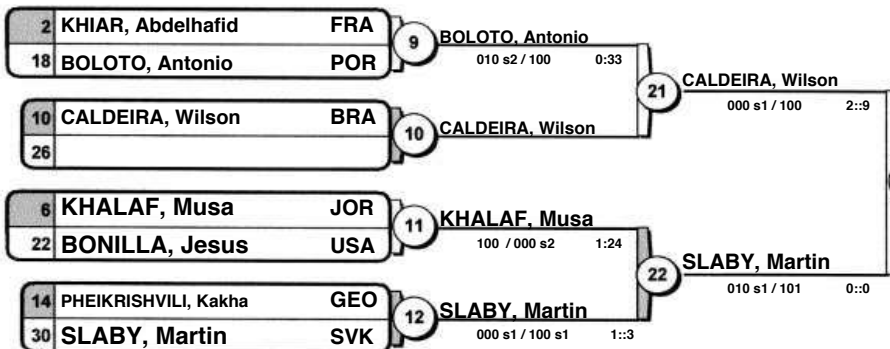

Pool C - Winner
Vainqueur / Sieger

POOL D

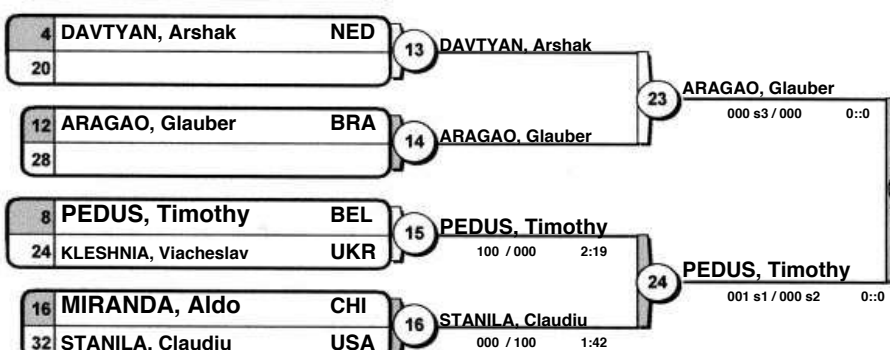

Pool D - Winner
Vainqueur / Sieger

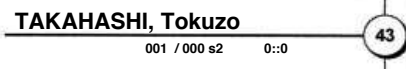

1.

Results	
Résultat / Platzierungen	
1.	TAKAHASHI, Tokuzo JPN
2.	CALDEIRA, Wilson BRA
3.	ARAGAO, Glauber BRA
3.	POELS, Wilhelmus NED
5.	ZAPATA, Rene CHI
5.	SLABY, Martin SVK
7.	BELLO, Leandro BRA
7.	PEDUS, Timothy BEL

Repechage / Trostrunde

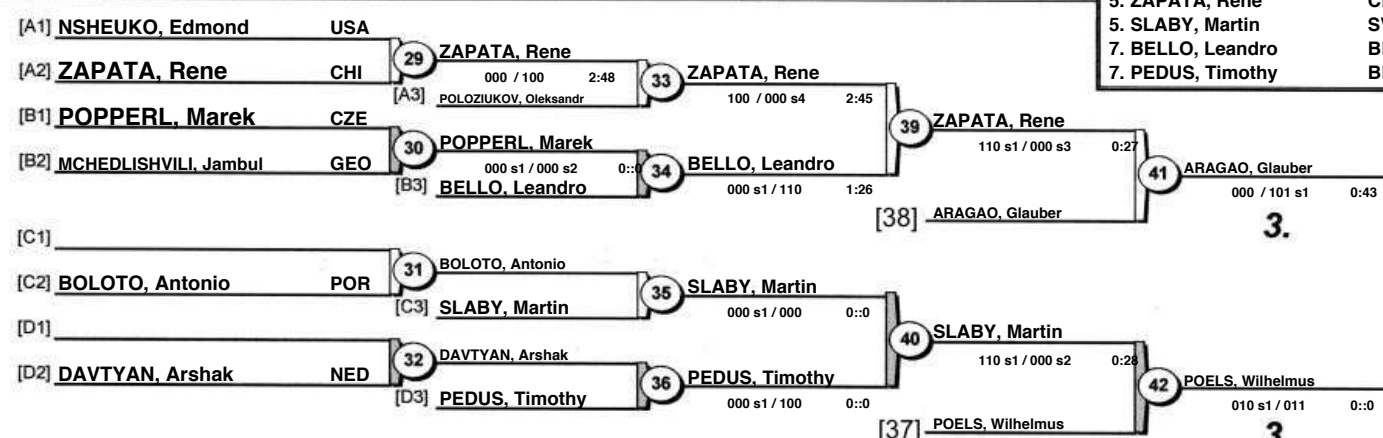

3.

3.



Veterans World Judo Championships 2016

(USA Fort Lauderdale, 18-21 November 2016)

M3 +100 kg

19 Judoka

POOL A

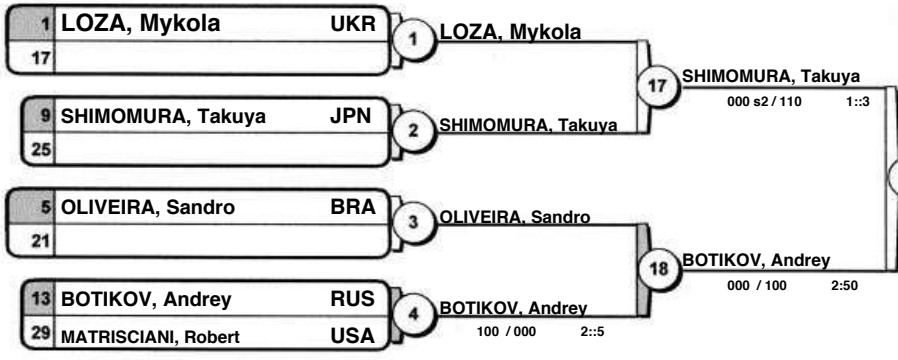

Pool A - Winner
Vainqueur / Sieger

POOL B

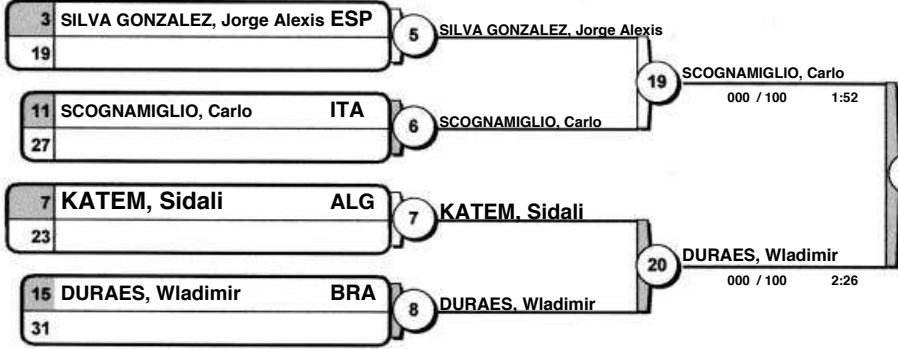

Pool B - Winner
Vainqueur / Sieger

POOL C



Pool C - Winner
Vainqueur / Sieger

POOL D



Pool D - Winner
Vainqueur / Sieger

Results	
Résultat / Platzierungen	
1.	DAVITASHVILI, Alexsi GEO
2.	SCOGNAMIGLIO, Carlo ITA
3.	FIEBIG, Elton BRA
3.	BOTIKOV, Andrey RUS
5.	DURAES, Wladimir BRA
5.	WEBER, Lars GER
7.	OLIVEIRA, Sandro BRA
7.	BARKAR, Ruslan UKR

Repechage / Trostrunde

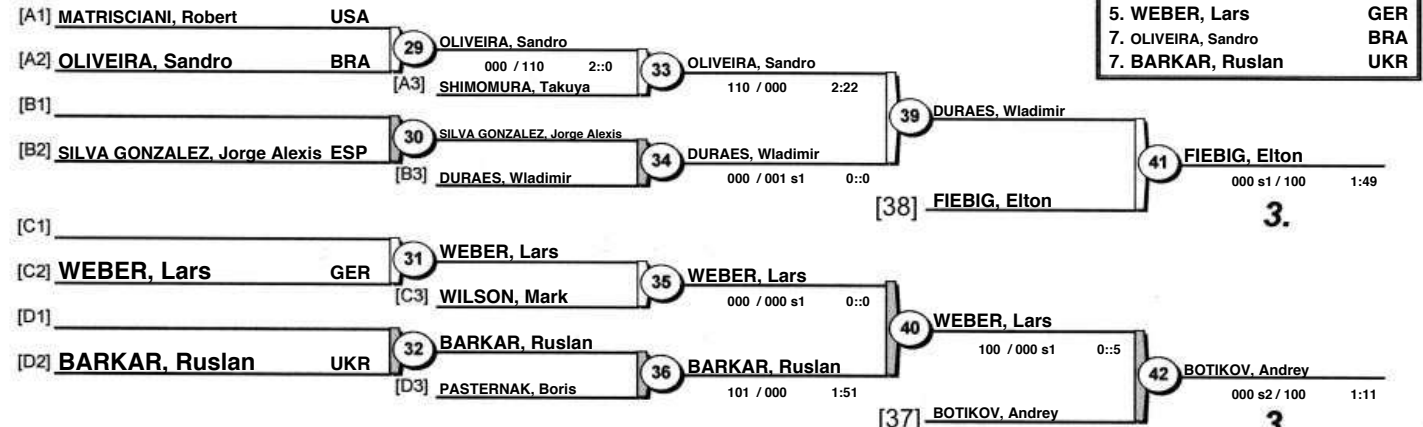



Veterans World Judo Championships 2016

(USA Fort Lauderdale, 18-21 November 2016)

M4 -60 kg

7 Judoka

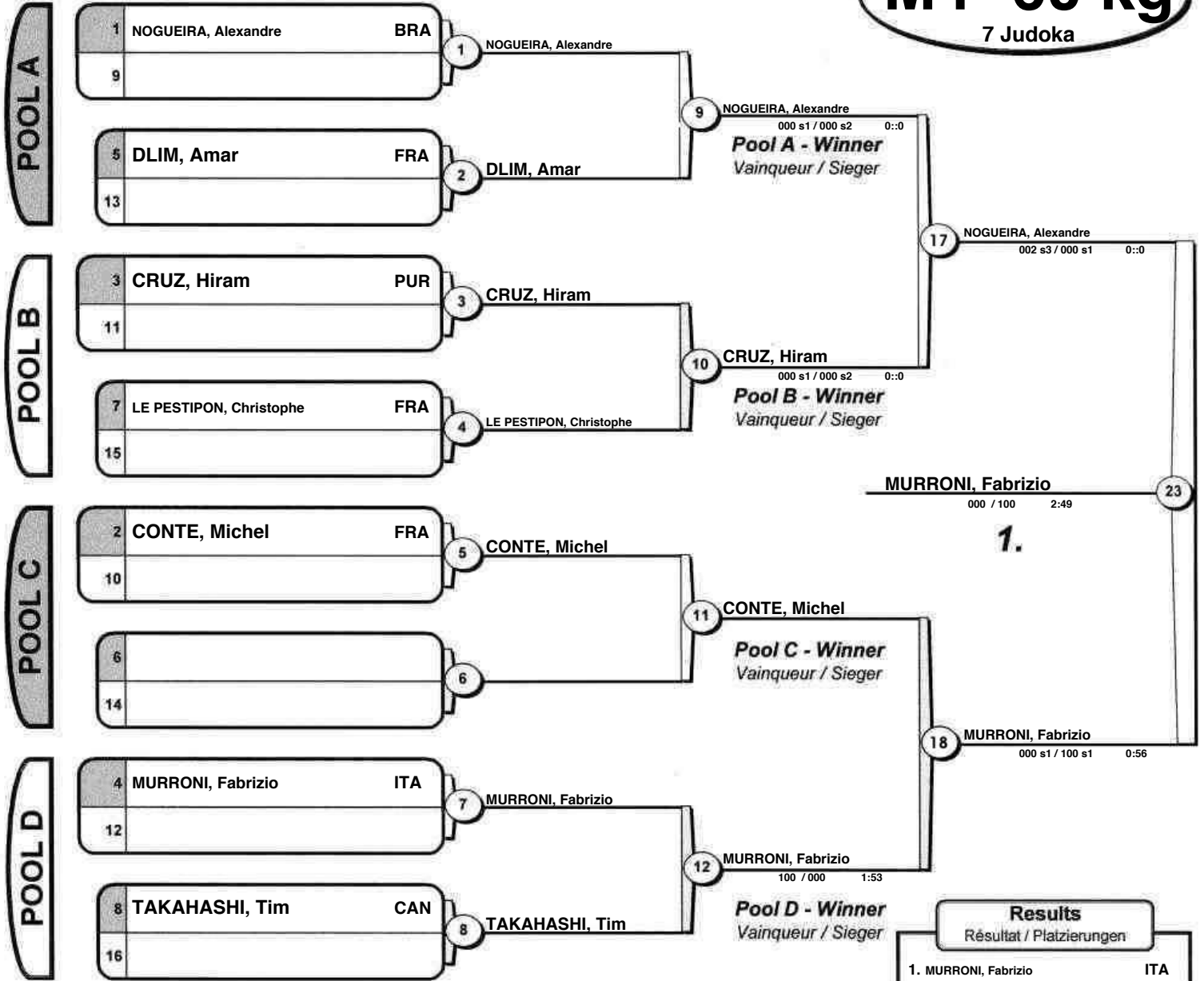

Results	
Résultat / Platzierungen	
1.	MURRONI, Fabrizio (ITA)
2.	NOGUEIRA, Alexandre (BRA)
3.	CONTE, Michel (FRA)
3.	TAKAHASHI, Tim (CAN)
5.	LE PESTIPON, Christophe (FRA)
5.	CRUZ, Hiram (PUR)
7.	DLIM, Amar (FRA)

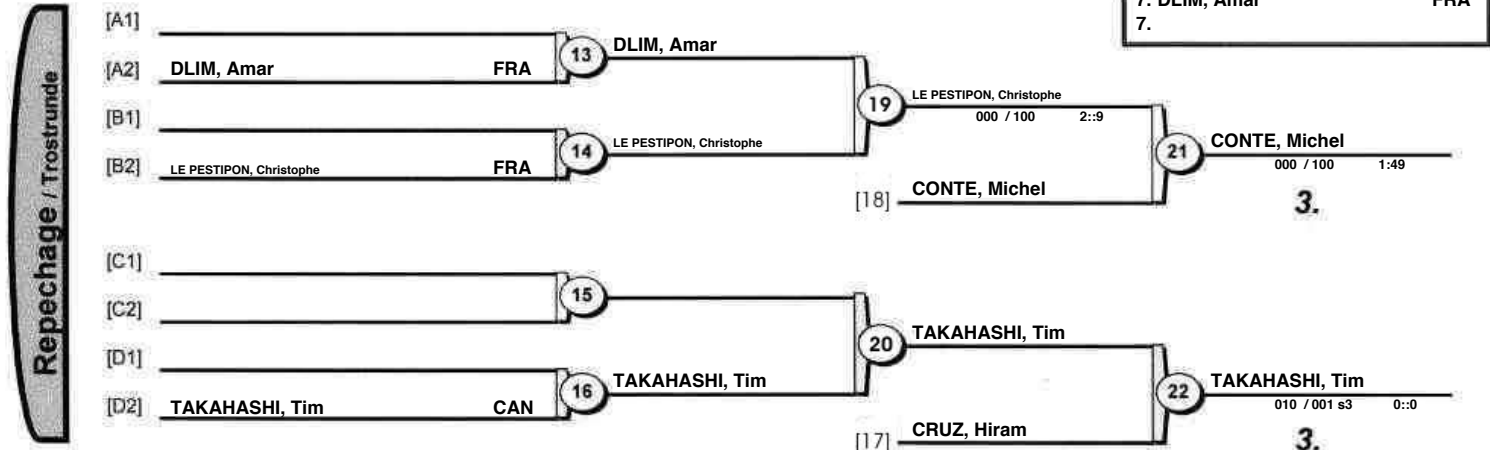



Veterans World Judo Championships 2016

(USA Fort Lauderdale, 18-21 November 2016)

M4 -66 kg

14 Judoka

POOL A

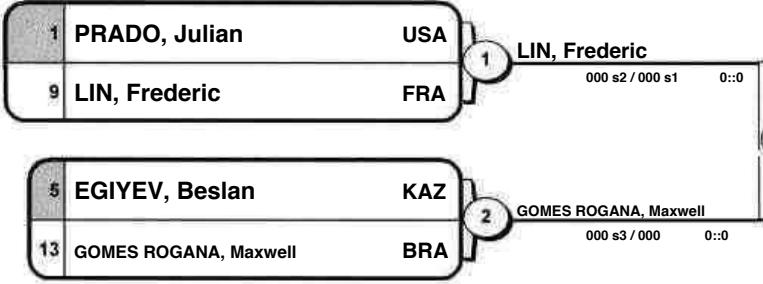

POOL B

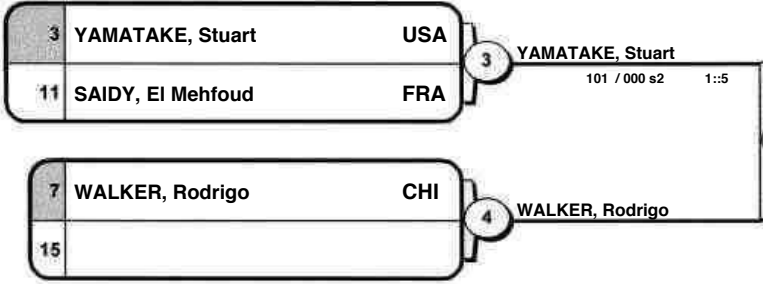

POOL C

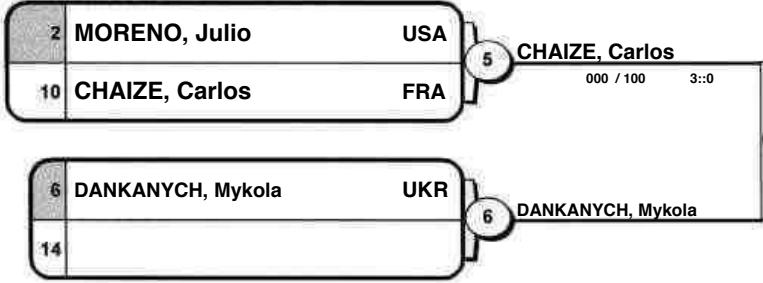

POOL D

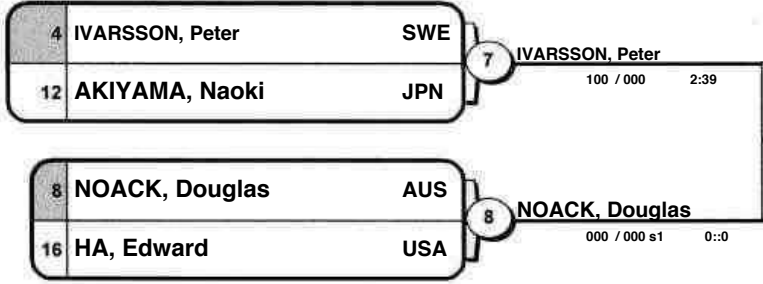

LIN, Frederic
000 s1 / 000 s2 0:0

1.

CHAIZE, Carlos
100 / 000 1:6

Results		
Résultat / Platzierungen		
1.	LIN, Frederic	FRA
2.	CHAIZE, Carlos	FRA
3.	IVARSSON, Peter	SWE
3.	YAMATAKE, Stuart	USA
5.	WALKER, Rodrigo	CHI
5.	DANKANYCH, Mykola	UKR
7.	GOMES ROGANA, Maxwell	BRA
7.	NOACK, Douglas	AUS

Repechage / Trostrunde

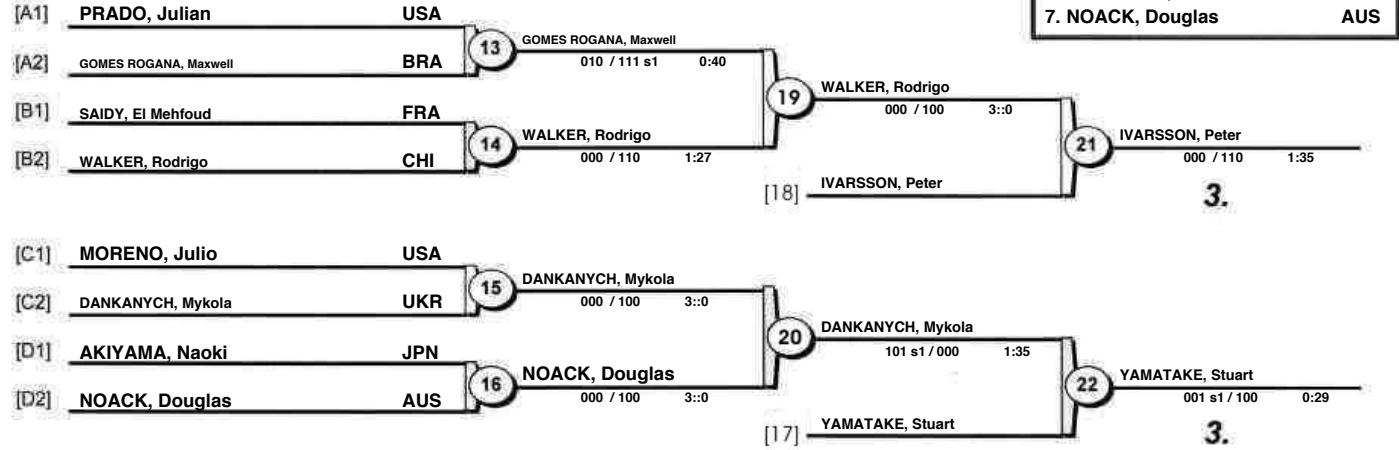



Veterans World Judo Championships 2016

(USA Fort Lauderdale, 18-21 November 2016)

M4 -73 kg

23 Judoka

POOL A

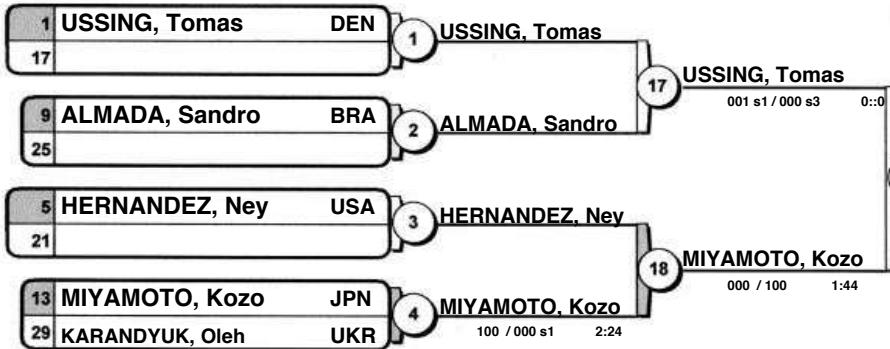

MIYAMOTO, Kozo
000 / 100 2:42
Pool A - Winner
Vainqueur / Sieger

POOL B

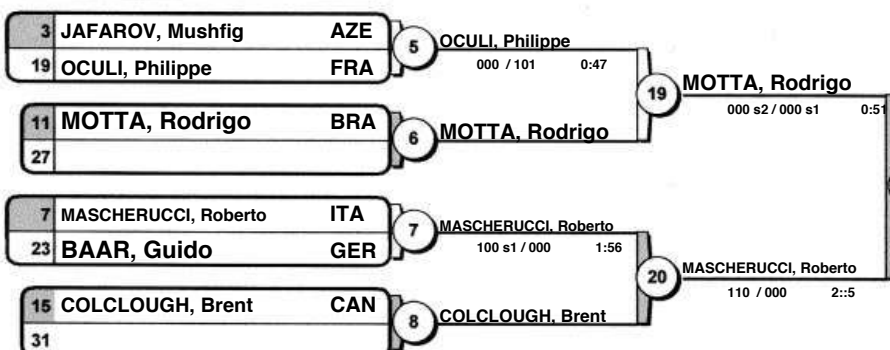

MASCHERUCCI, Roberto
000 s1 / 010 s2 0:0
Pool B - Winner
Vainqueur / Sieger

POOL C



LUTSENKO, Lev
000 / 000 s1 0:0
Pool C - Winner
Vainqueur / Sieger

POOL D



MBANI, Christian
000 / 010 s2 0:0
Pool D - Winner
Vainqueur / Sieger



1.

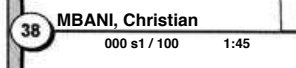

Results		
Résultat / Platzierungen		
1.	MIYAMOTO, Kozo	JPN
2.	MBANI, Christian	FRA
3.	MOTTA, Rodrigo	BRA
	MASCHERUCCI, Roberto	ITA
5.	LUTSENKO, Lev	UKR
	HOMOLA, Vladimir	SVK
7.	HERNANDEZ, Ney	USA
	LAATS, Lode	BEL

Repechage / Trostrunde

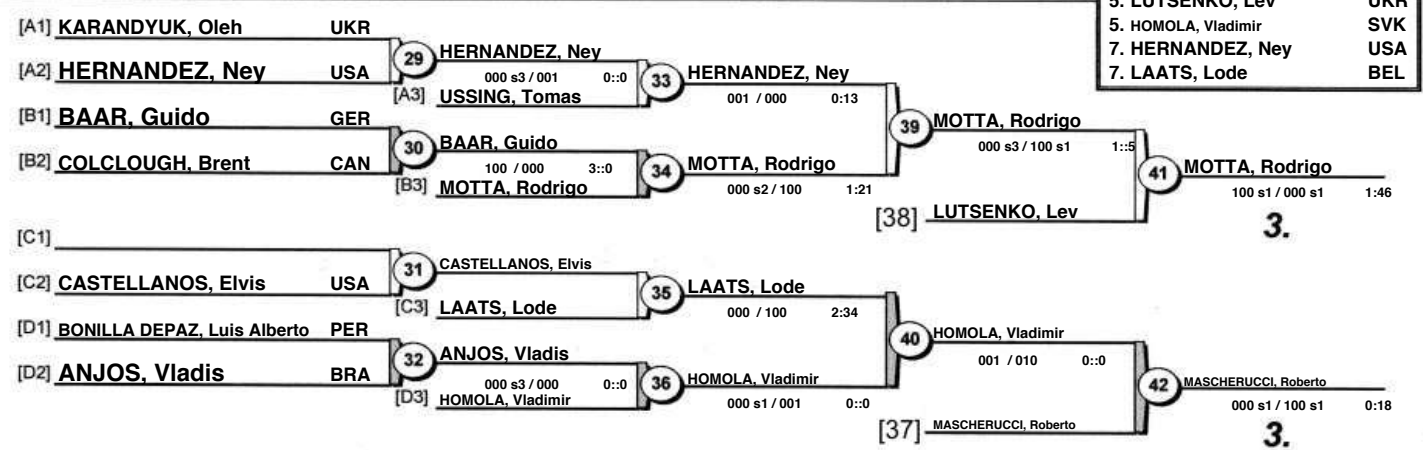

3.

3.



Veterans World Judo Championships 2016

(USA Fort Lauderdale, 18-21 November 2016)

M4 -81 kg

35 Judoka

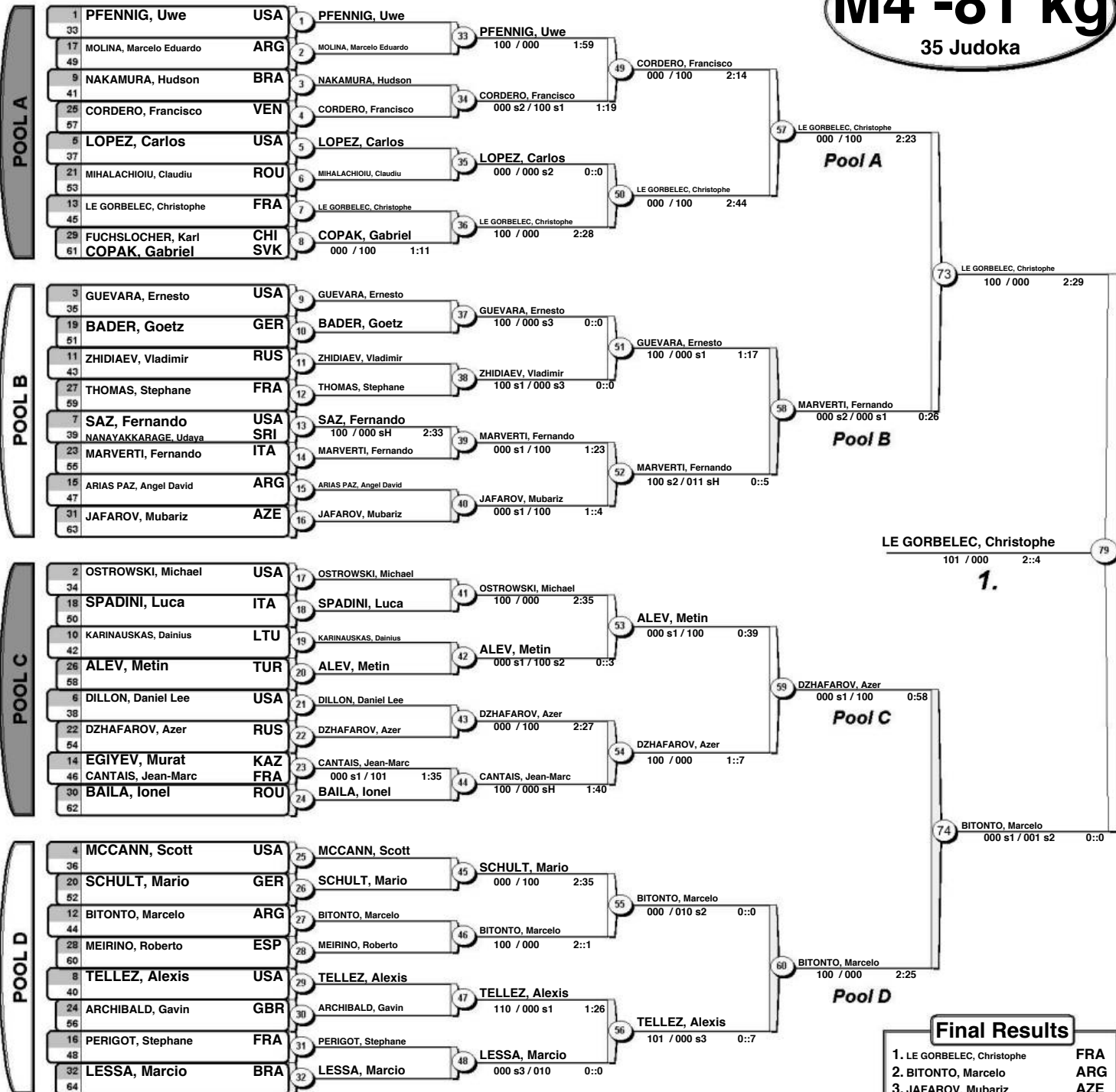

Repechage

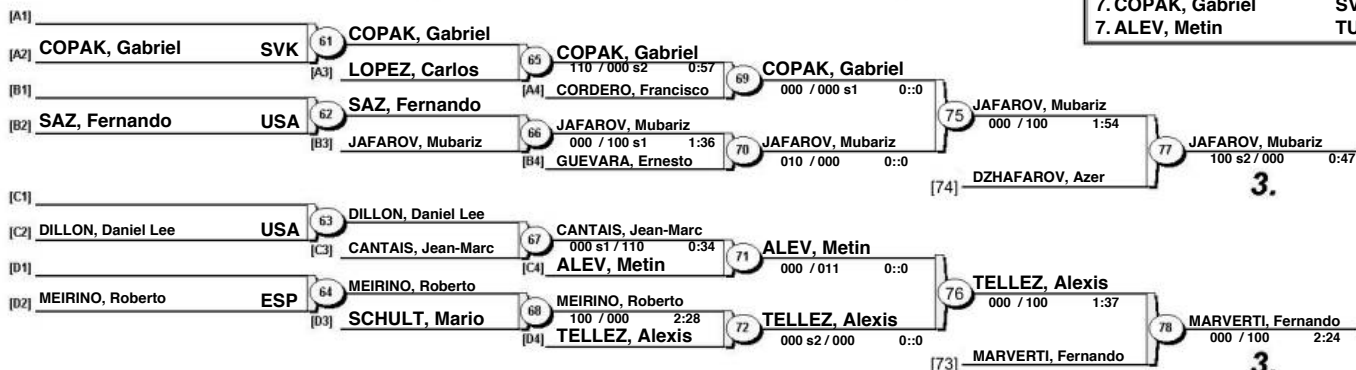



Veterans World Judo Championships 2016

(USA Fort Lauderdale, 18-21 November 2016)

M4 -90 kg

28 Judoka

POOL A

1	TABATADZE, Teimuraz	USA	1	TABATADZE, Teimuraz	100 / 000 s4	2:50
17	MARIN, Philippe	PYF	17	TIULKIN, Vitalii	000 / 001 s1	0:0
9	TIULKIN, Vitalii	RUS	2	TIULKIN, Vitalii	100 s1 / 000	1:17
25	CAHALANE, Lee	GBR	25	TIULKIN, Vitalii	000 s2 / 000 s3	0:0
5	SANDERS, Armando	USA	3	SANDERS, Armando		
21			18	FALCAO JUNIOR, Edison	000 / 100	2:42
13	FALCAO JUNIOR, Edison	BRA	4	FALCAO JUNIOR, Edison	010 s3 / 000	0:0
29	SCHULEIT, Boris	DEN	4			

Pool A - Winner
Vainqueur / Sieger

POOL B

3	MCGUIRE, Jason	USA	5	VARVARIUC, Ion	000 / 110	1:42
19	VARVARIUC, Ion	MDA	19	VARVARIUC, Ion	100 / 000	2:40
11	FABIANO, Pasquale	ITA	6	FABIANO, Pasquale		
27			20	BORISOV, Oleg	000 s1 / 110 s1	1:41
7	SANCHEZ, Ramon	USA	7	KHIREDDINE, Ali	000 / 100	2:46
23	KHIREDDINE, Ali	FRA	20	BORISOV, Oleg	000 s2 / 010 s3	0:0
15	BORISOV, Oleg	RUS	8	BORISOV, Oleg	100 / 000 s2	0:53
31	SAIKALY, Fady	LIB	8			

Pool B - Winner
Vainqueur / Sieger

POOL C

2	WHITAKER, Michael	USA	9	SEIDAKHMETOV, Sabit	000 / 110	2:12
18	SEIDAKHMETOV, Sabit	RUS	21	SEIDAKHMETOV, Sabit	010 / 000 s1	0:0
10	KINGSTON, Stuart	GBR	10	BAKER, Karl	000 s4 / 110	1:43
26	BAKER, Karl	SWE	27	CABRERA, Christian	000 s2 / 000	0:0
6	GARCIA-LAGARES, Jorge	USA	11	GARCIA-LAGARES, Jorge		
22			22	CABRERA, Christian	000 / 100	2:15
14	MOUHOUBI, Mustapha	ALG	12	CABRERA, Christian	000 s3 / 000	0:0
30	CABRERA, Christian	MEX	12			

Pool C - Winner
Vainqueur / Sieger

POOL D

4	WEATE, Matthew	USA	13	SANOEV, Navruzmkhmad	000 / 100	2:16
20	SANOEV, Navruzmkhmad	RUS	23	SANOEV, Navruzmkhmad	010 / 000 s2	0:0
12	SOLANKI, Ranbir	IND	14	SOLANKI, Ranbir		
28			28	BABJAK, Peter	000 s3 / 001	0:0
8	BALLESTERO, Michael	USA	15	TERUEL, Enrique	000 s1 / 100	2:11
24	TERUEL, Enrique	ESP	24	BABJAK, Peter	000 / 110	1:36
16	BABJAK, Peter	CZE	16	BABJAK, Peter	100 / 000 s1	1:0
32	PRESSELLO, Stefano	ITA	16			

Pool D - Winner
Vainqueur / Sieger

BABJAK, Peter

000 s4 / 100 0:46

1.

BABJAK, Peter

000 s1 / 100 1:38

Results

Résultat / Platzierungen

1. BABJAK, Peter CZE
2. BORISOV, Oleg RUS
3. CABRERA, Christian MEX
3. PRESSELLO, Stefano ITA
5. TABATADZE, Teimuraz USA
5. TIULKIN, Vitalii RUS
7. VARVARIUC, Ion MDA
7. MOUHOUBI, Mustapha ALG

Repechage / Trostrunde

[A1]	CAHALANE, Lee	GBR	29	TABATADZE, Teimuraz	000 s1 / 011	0:0	33	TABATADZE, Teimuraz	110 s1 / 000	1:7
[A2]	TABATADZE, Teimuraz	USA	[A3]	FALCAO JUNIOR, Edison			39	TABATADZE, Teimuraz	010 s2 / 000 s1	0:0
[B1]	SAIKALY, Fady	LIB	30	KHIREDDINE, Ali	000 s2 / 000 s1	0:15	34	VARVARIUC, Ion	000 / 010 s2	0:0
[B2]	KHIREDDINE, Ali	FRA	[B3]	VARVARIUC, Ion			[38]	CABRERA, Christian		
[C1]	MOUHOUBI, Mustapha	ALG	31	MOUHOUBI, Mustapha	110 s2 / 000 s1	1:8	35	MOUHOUBI, Mustapha	000 s1 / 000 s2	0:0
[C2]	GARCIA-LAGARES, Jorge	USA	[C3]	SEIDAKHMETOV, Sabit			40	PRESSELLO, Stefano	000 s1 / 100 s1	0:54
[D1]	PRESSELLO, Stefano	ITA	32	PRESSELLO, Stefano	001 / 001 s1	0:0	36	PRESSELLO, Stefano	000 s2 / 000 s3	0:0
[D2]	TERUEL, Enrique	ESP	[D3]	SANOEV, Navruzmkhmad			[37]	TIULKIN, Vitalii		

3.

3.



Veterans World Judo Championships 2016

(USA Fort Lauderdale, 18-21 November 2016)

M4 -100 kg

22 Judoka

POOL A

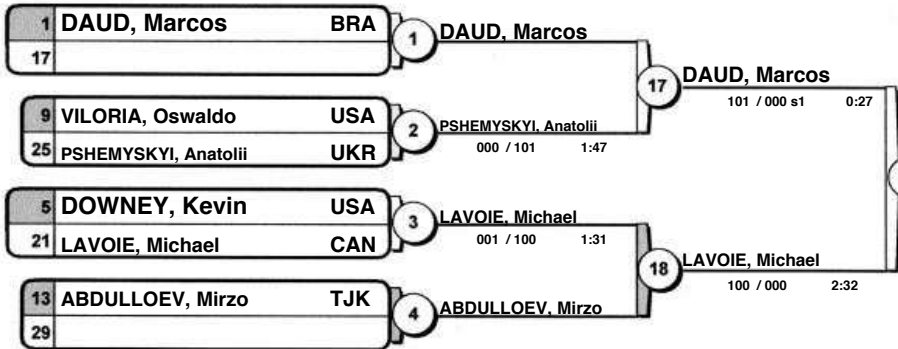

Pool A - Winner
Vainqueur / Sieger

POOL B

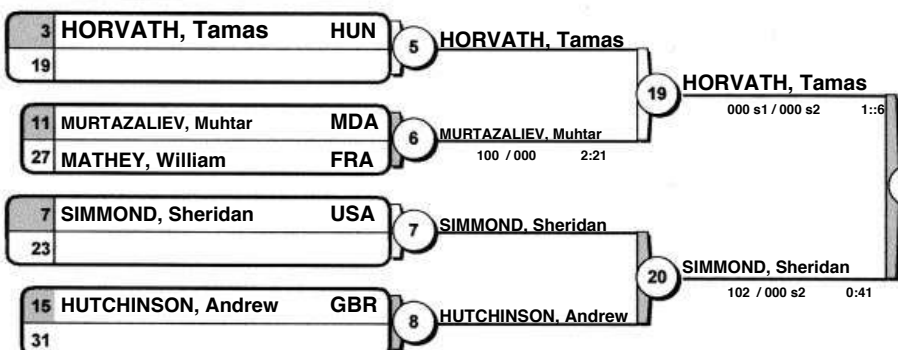

Pool B - Winner
Vainqueur / Sieger

POOL C

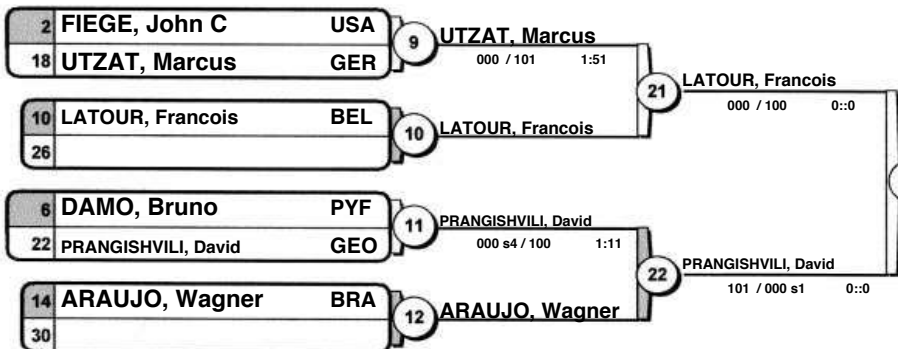

Pool C - Winner
Vainqueur / Sieger

POOL D

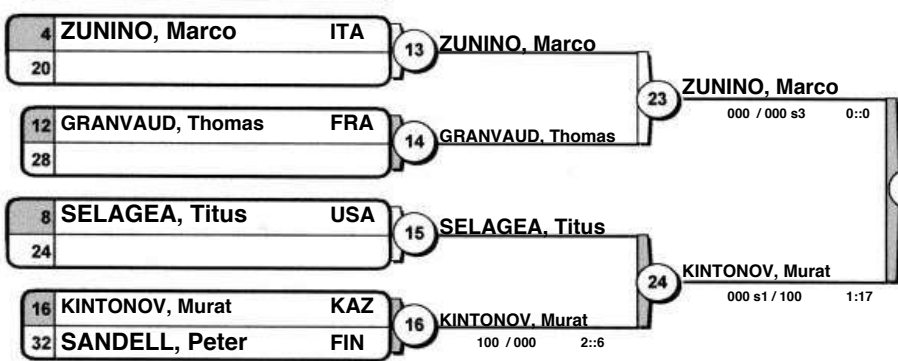

Pool D - Winner
Vainqueur / Sieger



1.

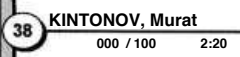

2.



3.

Results	
Résultat / Platzierungen	
1.	KINTONOV, Murat KAZ
2.	DAUD, Marcos BRA
3.	MURTAZALIEV, Muhtar MDA
3.	HORVATH, Tamas HUN
5.	LATOUR, Francois BEL
5.	UTZAT, Marcus GER
7.	PSHEMYSKYI, Anatolii UKR
7.	ZUNINO, Marco ITA

Repechage / Trostrunde

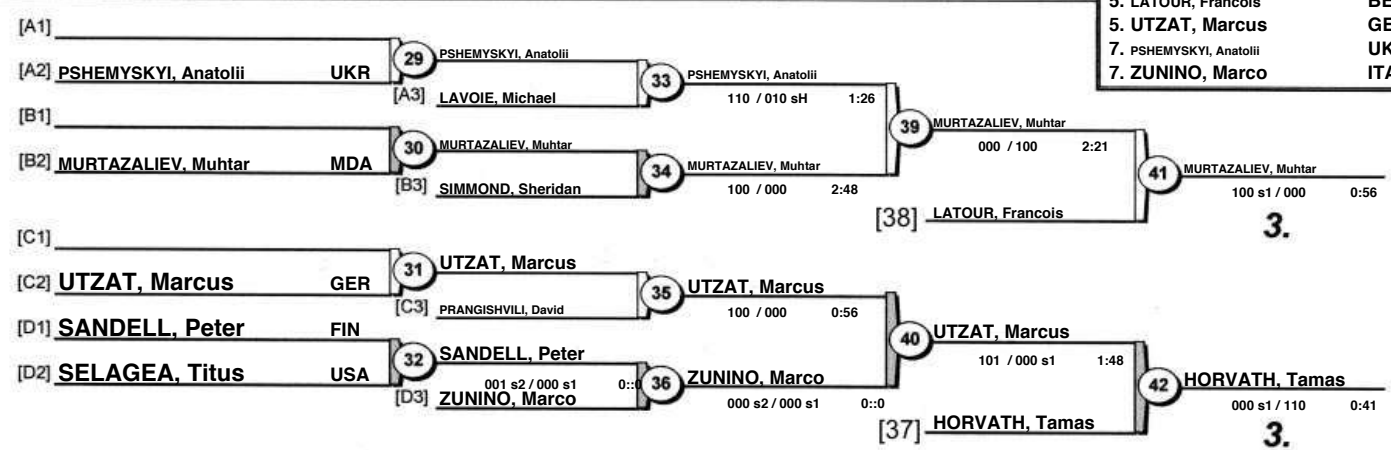

3.



Veterans World Judo Championships 2016

(USA Fort Lauderdale, 18-21 November 2016)

M4 +100 kg

16 Judoka

POOL A

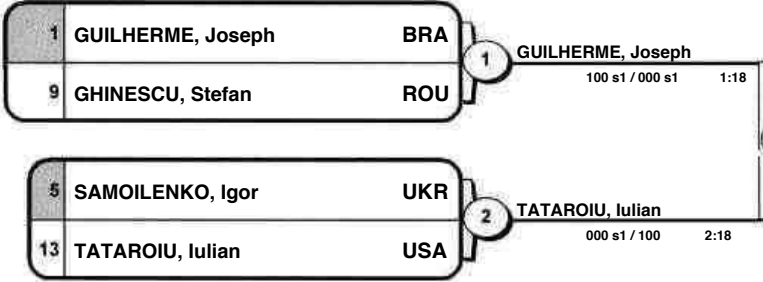

POOL B

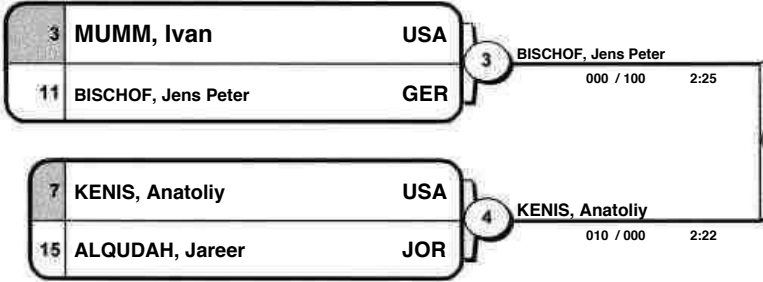

POOL C

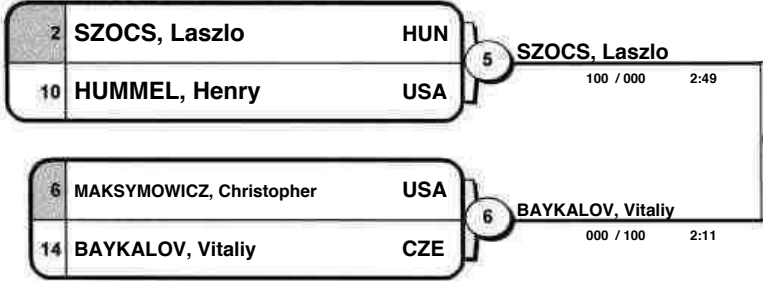

POOL D

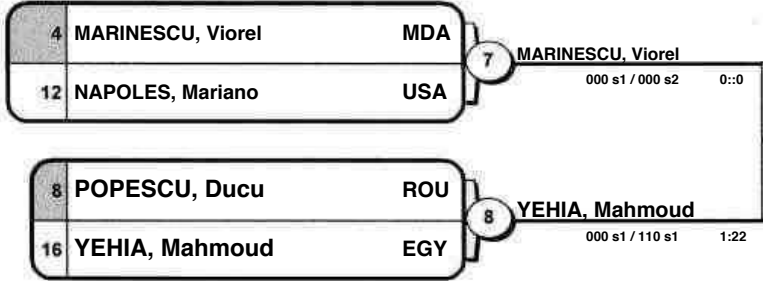

1.



Pool C - Winner
Vainqueur / Sieger



3.

Results		
Résultat / Platzierungen		
1.	GUILHERME, Joseph	BRA
2.	SZOCS, Laszlo	HUN
3.	MARINESCU, Viorel	MDA
3.	BISCHOF, Jens Peter	GER
5.	TATAROIU, Iulian	USA
5.	BAYKALOV, Vitaliy	CZE
7.	KENIS, Anatoliy	USA
7.	YEHIA, Mahmoud	EGY

Repechage / Trostrunde

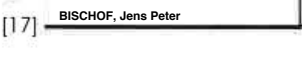
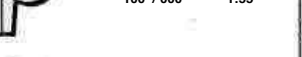
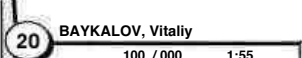
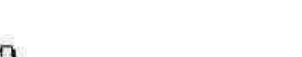
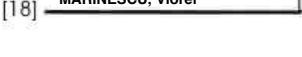
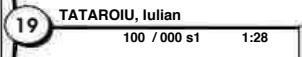
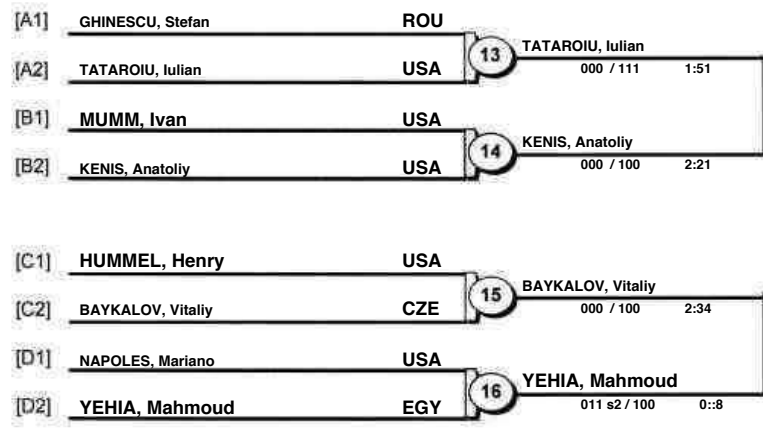

3.



Veterans World Judo Championships 2016

(USA Fort Lauderdale, 18-21 November 2016)

M5 -60 kg

4 Judoka

			1	2	3	4			
1	ORGEE, Edward	GBR		0	0	0	(0)		
2	ROZAND, Michel	FRA	1 (100)		0	0	1 (100)		
3	VIEGA, Jose	USA	1 (100)	1 (100)		1 (10)	3 (210)		
4	MOHINO MINAYA, Juan Carlos	ESP	1 (100)	1 (100)	0		2 (200)		

1	ORGEE, Edward	GBR	①	ROZAND, Michel	FRA
2	ROZAND, Michel	FRA		000 / 100	3::0

3	VIEGA, Jose	USA	②	VIEGA, Jose	USA
4	MOHINO MINAYA, Juan Carlos	ESP		010 / 000 s1	0::0

1	ORGEE, Edward	GBR	③	VIEGA, Jose	USA
3	VIEGA, Jose	USA		000 / 100	2:58

2	ROZAND, Michel	FRA	④	MOHINO MINAYA, Juan Carlos	ESP
4	MOHINO MINAYA, Juan Carlos	ESP		000 s2 / 100 s2	0:54

1	ORGEE, Edward	GBR	⑤	MOHINO MINAYA, Juan Carlos	ESP
4	MOHINO MINAYA, Juan Carlos	ESP		000 / 100	2:59

2	ROZAND, Michel	FRA	⑥	VIEGA, Jose	USA
3	VIEGA, Jose	USA		000 s1 / 100	1::1

Final Results

1. VIEGA, Jose USA
2. MOHINO MINAYA, Juan Carlos ESP
3. ROZAND, Michel FRA
- 3.



Veterans World Judo Championships 2016

(USA Fort Lauderdale, 18-21 November 2016)

M5 -66 kg

15 Judoka

POOL A

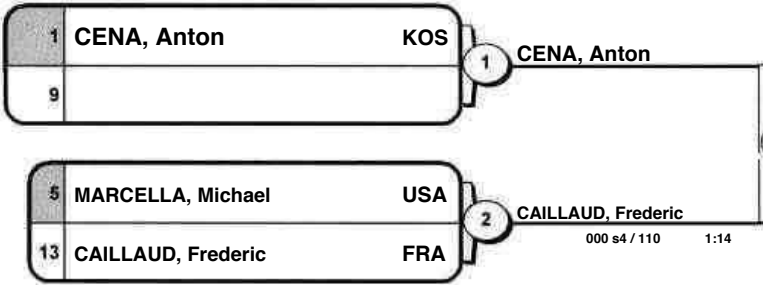

POOL B

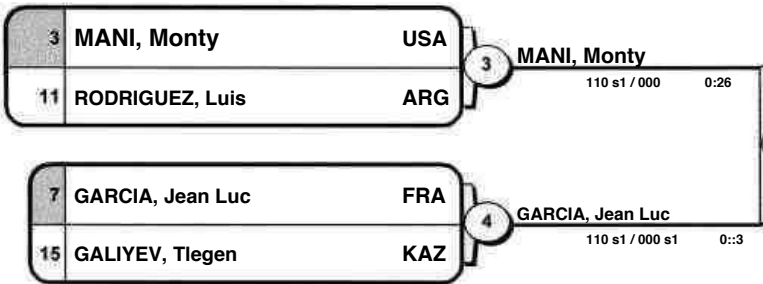

POOL C

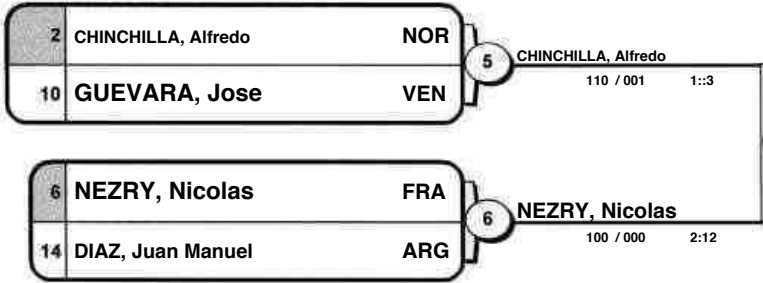

POOL D

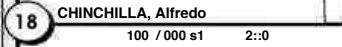
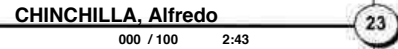
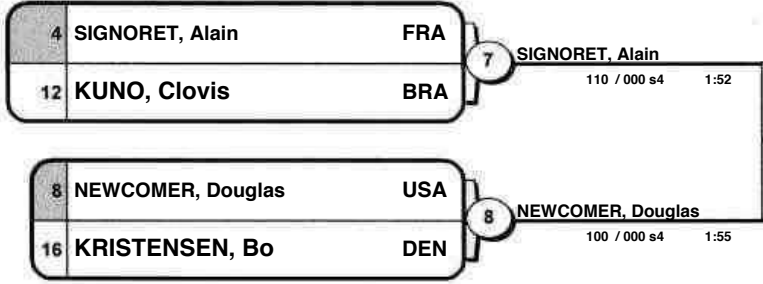

Results	
Résultat / Platzierungen	
1.	CHINCHILLA, Alfredo NOR
2.	CENA, Anton KOS
3.	SIGNORET, Alain FRA
3.	KUNO, Clovis BRA
5.	CAILLAUD, Frederic FRA
5.	GARCIA, Jean Luc FRA
7.	MANI, Monty USA
7.	NEZRY, Nicolas FRA

Repechage / Trostrunde

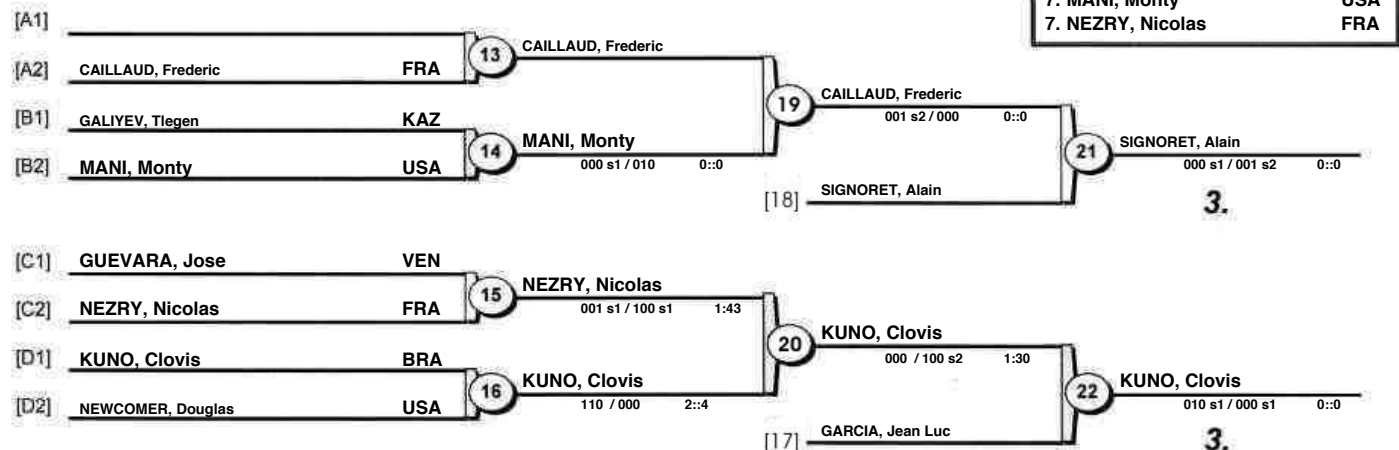



Veterans World Judo Championships 2016

(USA Fort Lauderdale, 18-21 November 2016)

M5 -73 kg

26 Judoka

POOL A

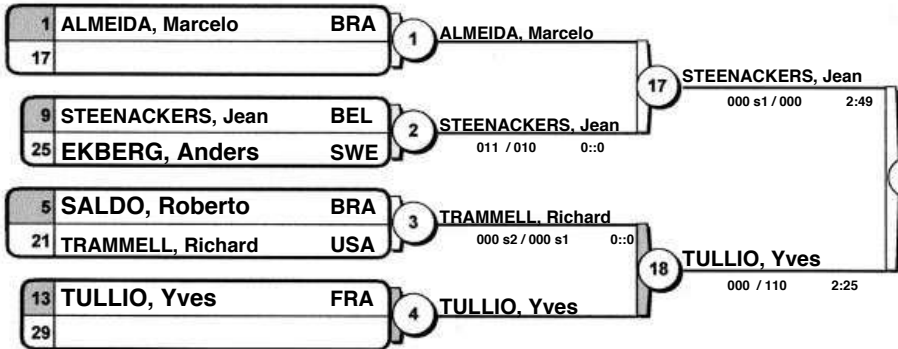

POOL B

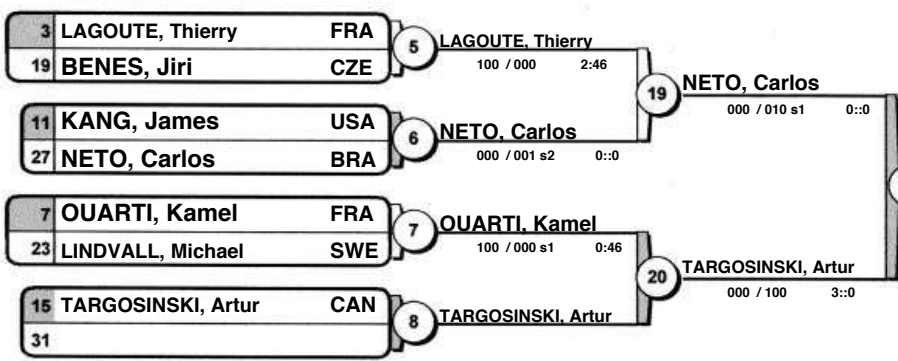

POOL C

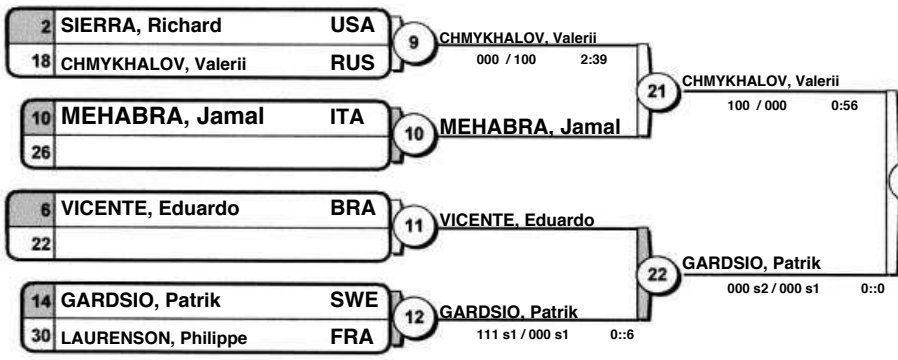

POOL D

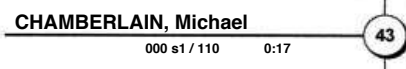
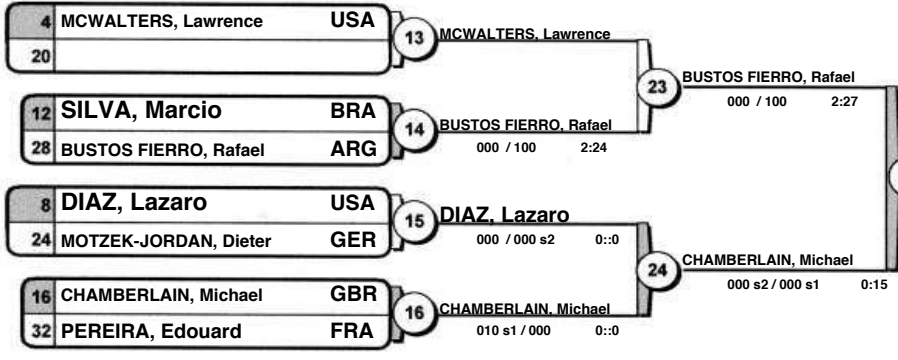

1.

Pool C - Winner
Vainqueur / Sieger

Pool D - Winner
Vainqueur / Sieger

Results Résultat / Platzierungen

1. CHAMBERLAIN, Michael GBR
2. TULLIO, Yves FRA
3. CHMYKHALOV, Valerii RUS
3. NETO, Carlos BRA
5. TARGOSINSKI, Artur CAN
5. BUSTOS FIERRO, Rafael ARG
7. TRAMMELL, Richard USA
7. GARDSIO, Patrik SWE

Repechage / Trostrunde

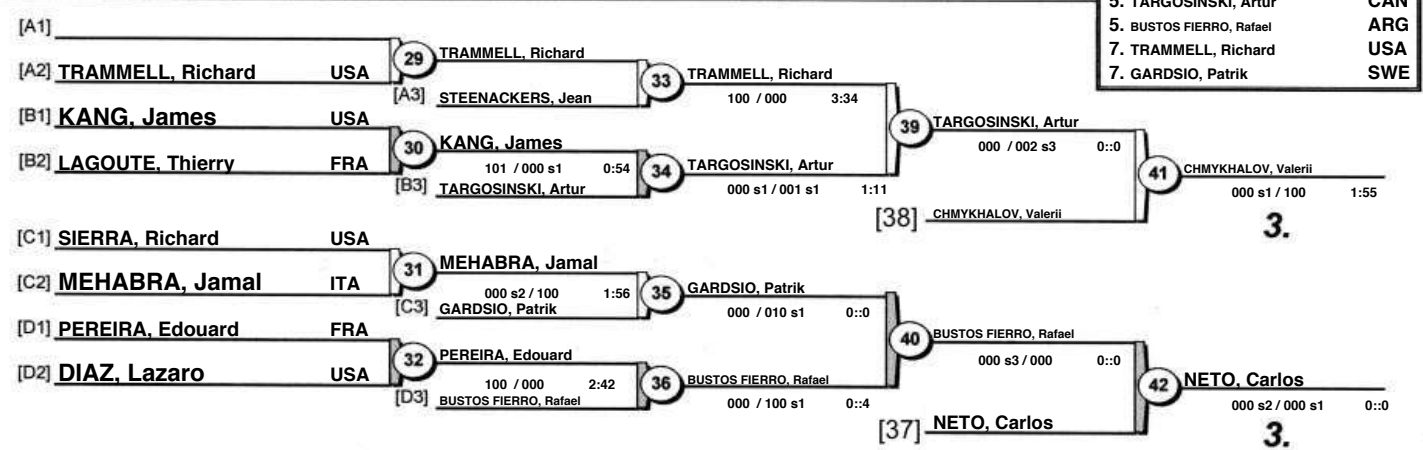

3.

3.



Veterans World Judo Championships 2016

(USA Fort Lauderdale, 18-21 November 2016)

M5 -81 kg

23 Judoka

POOL A

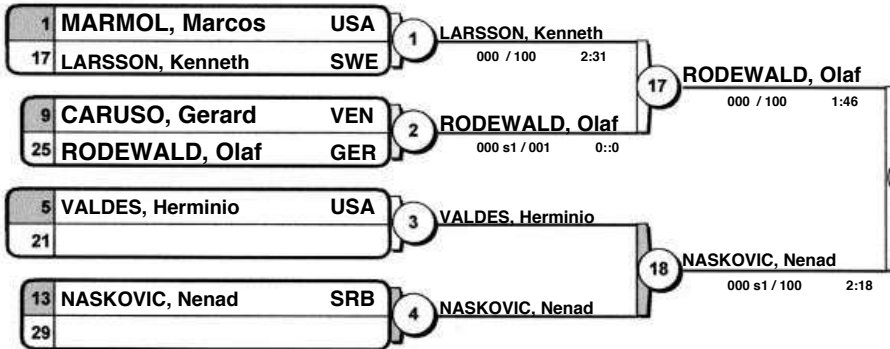

POOL B

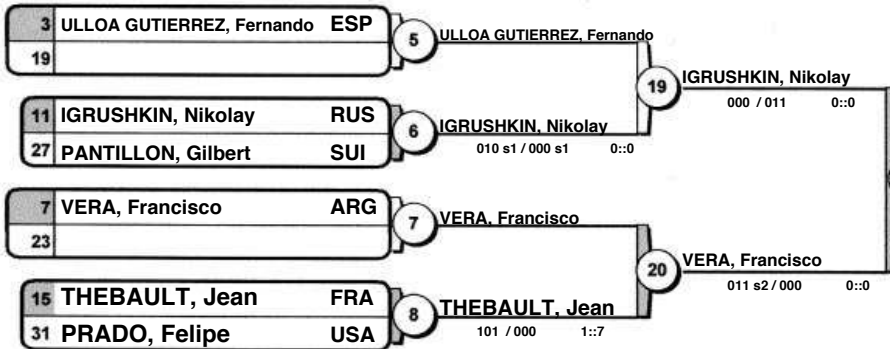

POOL C

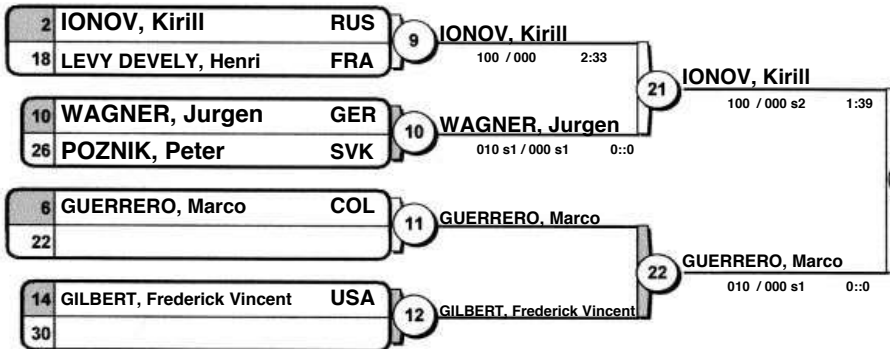

POOL D



Results	
Résultat / Platzierungen	
1.	IGRUSHKIN, Nikolay RUS
2.	IONOV, Kirill RUS
3.	TRINCA, Marco BRA
3.	RODEWALD, Olaf GER
5.	NASKOVIC, Nenad SRB
7.	CUMMINS, Paul IRL
7.	VERA, Francisco ARG
7.	WAGNER, Jurgen GER

Repechage / Trostrunde

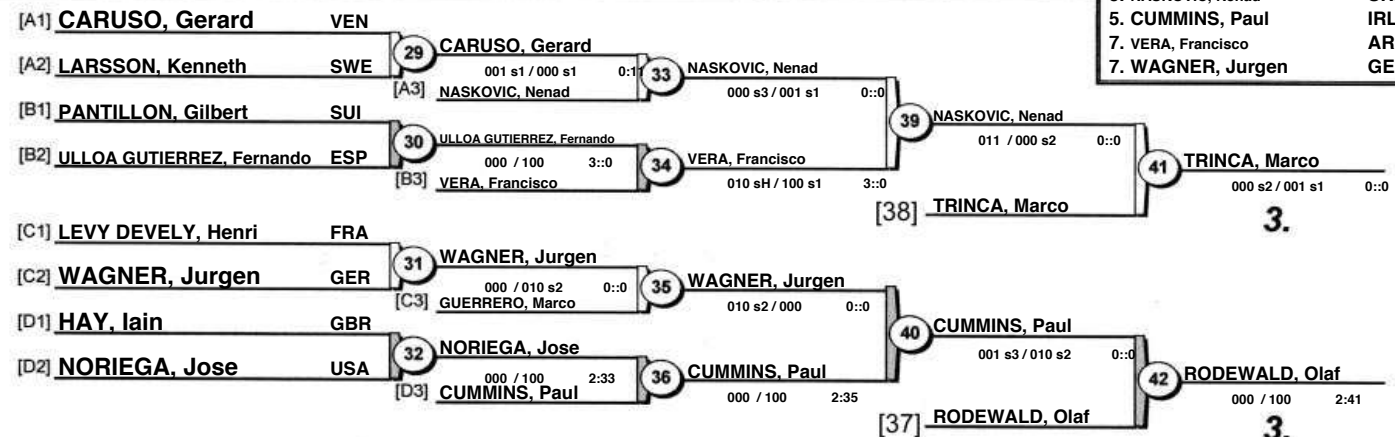



Veterans World Judo Championships 2016

(USA Fort Lauderdale, 18-21 November 2016)

M5 -90 kg

25 Judoka

POOL A

1	KALININ, Andrey	RUS	1	KALININ, Andrey	100 / 000	2:17
17	SALVERY, Frederic	FRA	17	KALININ, Andrey	100 / 000	1:32
9	CHEROBIM, Rodrigo	BRA	2	CHEROBIM, Rodrigo		
25			25	KALININ, Andrey	100 / 000	2:1
5	CARVALHO, Marcio	BRA	3	LANGE, Olaf	000 / 101	1:36
21	LANGE, Olaf	GER	3	PEREZ, Gabriel	000 s1 / 000	0:0
13	CAMPOS, Andre	USA	4	PEREZ, Gabriel	000 s1 / 000	0:0
29	PEREZ, Gabriel	ARG	4			

Pool A - Winner
Vainqueur / Sieger

POOL B

3	HESSLER, David	USA	5	HESSLER, David		
19			19	EBENFELT, Staffan	000 / 101	2:24
11	WRIGHT, Arthur	USA	6	EBENFELT, Staffan	000 / 100	2:19
27	EBENFELT, Staffan	SWE	6			
7	FERGUSON, Michael	USA	7	HOWIE, Martin	001 / 100	1:47
23	HOWIE, Martin	GBR	7	ALMEIDA, David	000 / 010 s2	0:0
15	ALMEIDA, David	BRA	8	ALMEIDA, David		
31			8			

Pool B - Winner
Vainqueur / Sieger

POOL C

2	MESABLISHVILI, Nugzar	UKR	9	MESABLISHVILI, Nugzar		
18			21	CAGGIANO, Rinaldo	000 s3 / 000 s1	0:0
10	CAGGIANO, Rinaldo	BRA	10	CAGGIANO, Rinaldo	100 / 000 s1	1:43
26			27	CAGGIANO, Rinaldo	100 / 000 s1	1:43
6	ARAUJO, Claudio	BRA	11	KASPERSEN, Karsten	000 / 110	2:12
22	KASPERSEN, Karsten	DEN	11	KASPERSEN, Karsten	000 s1 / 000 s3	0:0
14	DICKIE, Marc	USA	12	CARRASCO, Pascal	000 s4 / 100 s2	0:3
30	CARRASCO, Pascal	FRA	12			

Pool C - Winner
Vainqueur / Sieger

POOL D

4	VETTORI, Armando	ITA	13	VETTORI, Armando		
20			23	VETTORI, Armando	100 / 000	2:5
12	MILLER, Garfield	USA	14	MILLER, Garfield	100 / 010 s1	2:0
28	PAULA, Reginaldo	BRA	14	VETTORI, Armando	100 / 000	2:38
8	SUTTON, Reginald	USA	15	SUTTON, Reginald		
24			24	KRIJGER, Petrus	000 / 011 s2	0:0
16	KARLSSON, Anders	SWE	16	KRIJGER, Petrus	010 s1 / 011 s1	0:0
32	KRIJGER, Petrus	NED	16			

Pool D - Winner
Vainqueur / Sieger

CAGGIANO, Rinaldo
000 s3 / 100 s1 0:12

1.

CAGGIANO, Rinaldo
100 / 000 s1 2:6

Results

Résultat / Platzierungen

- CAGGIANO, Rinaldo BRA
- EBENFELT, Staffan SWE
- VETTORI, Armando ITA
- MESABLISHVILI, Nugzar UKR
- WRIGHT, Arthur USA
- KALININ, Andrey RUS
- PEREZ, Gabriel ARG
- MILLER, Garfield USA

Repechage / Trostrunde

[A1]	SALVERY, Frederic	FRA	29	CHEROBIM, Rodrigo	000 s3 / 000 s1	0:0	33	PEREZ, Gabriel	000 s2 / 000 s1	0:0
[A2]	CHEROBIM, Rodrigo	BRA	[A3]	PEREZ, Gabriel			39	WRIGHT, Arthur	000 / 100	1:8
[B1]	WRIGHT, Arthur	USA	30	WRIGHT, Arthur	010 s1 / 000 s1	0:5	34	WRIGHT, Arthur	101 / 000	0:0
[B2]	HESSLER, David	USA	[B3]	ALMEIDA, David			[38]	VETTORI, Armando		
[C1]			31	MESABLISHVILI, Nugzar			35	MESABLISHVILI, Nugzar	100 / 000	2:44
[C2]	MESABLISHVILI, Nugzar	UKR	[C3]	KASPERSEN, Karsten			40	MESABLISHVILI, Nugzar	100 / 000	2:16
[D1]			32	MILLER, Garfield			36	MILLER, Garfield	110 / 001	1:54
[D2]	MILLER, Garfield	USA	[D3]	KRIJGER, Petrus			[37]	KALININ, Andrey	100 / 000	2:0

3.

3.



Veterans World Judo Championships 2016

(USA Fort Lauderdale, 18-21 November 2016)

M5 -100 kg

26 Judoka

POOL A

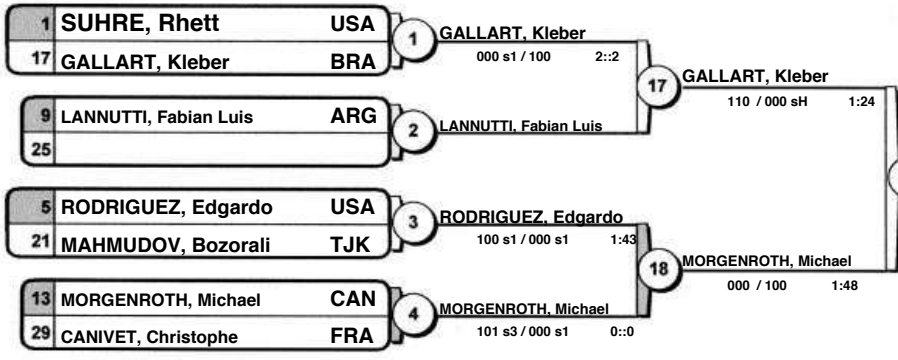

Pool A - Winner
Vainqueur / Sieger

POOL B

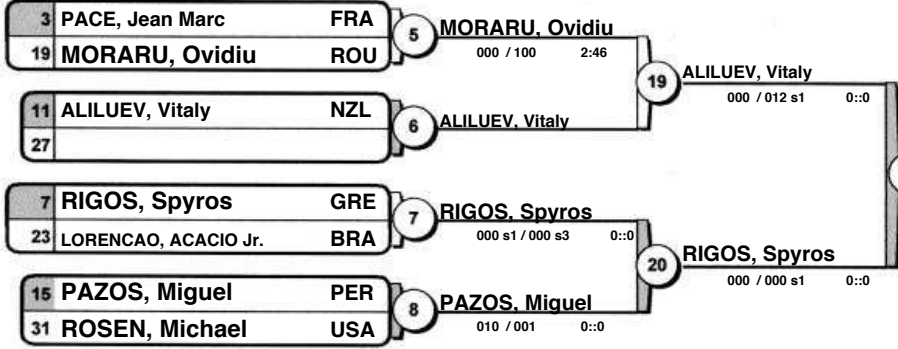

Pool B - Winner
Vainqueur / Sieger

POOL C



Pool C - Winner
Vainqueur / Sieger

POOL D

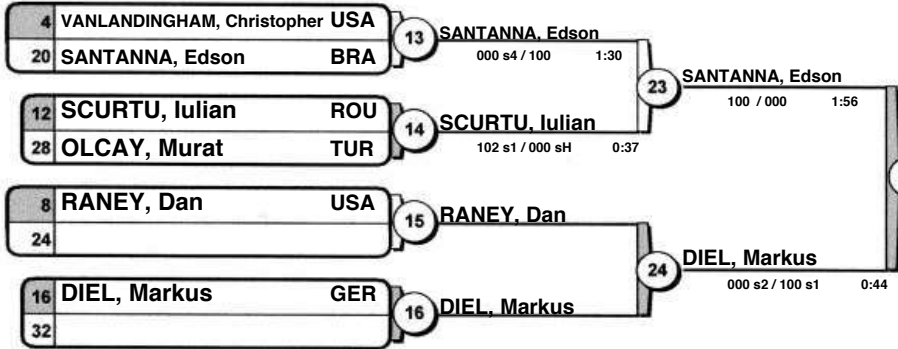

Pool D - Winner
Vainqueur / Sieger

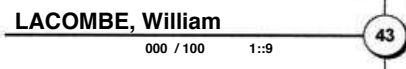

1.

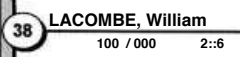

Results

Résultat / Platzierungen

1. LACOMBE, William FRA
2. ALILUEV, Vitaly NZL
3. MORARU, Ovidiu ROU
3. LOPOUCHANSKI, Alexandre USA
5. SANTANNA, Edson BRA
5. MORGENROTH, Michael CAN
7. CANIVET, Christophe FRA
7. DIEL, Markus GER

Repechage / Trostrunde

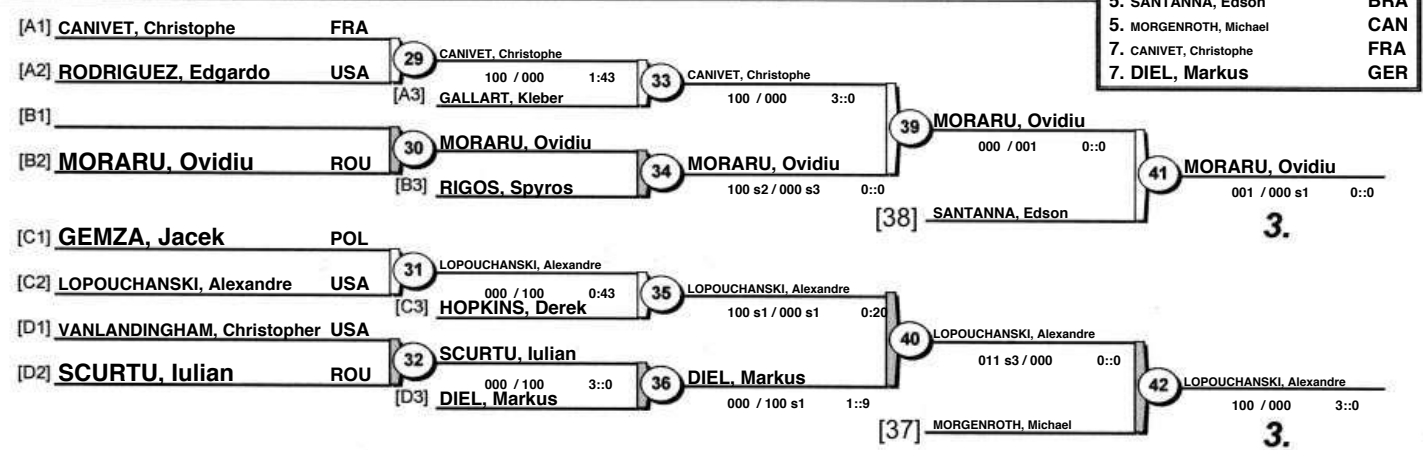

3.



Veterans World Judo Championships 2016

(USA Fort Lauderdale, 18-21 November 2016)

M5 +100 kg

11 Judoka

POOL A

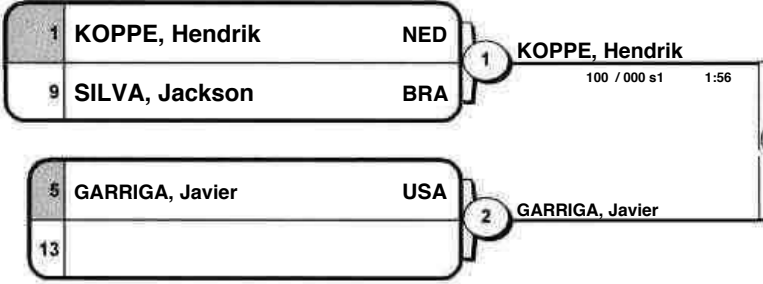

POOL B

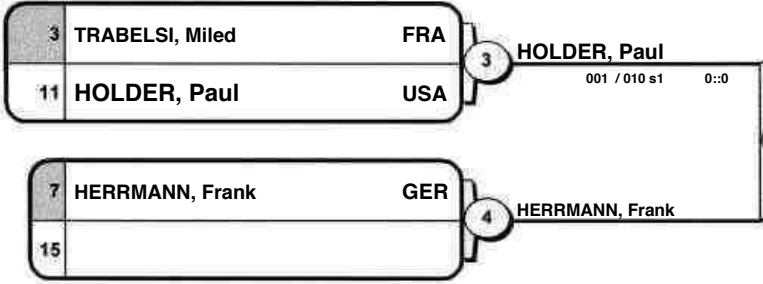

POOL C

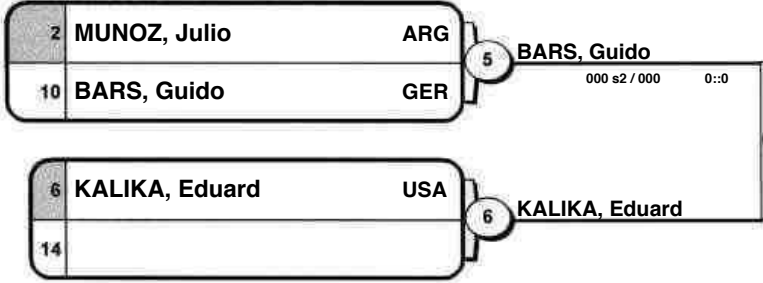

POOL D

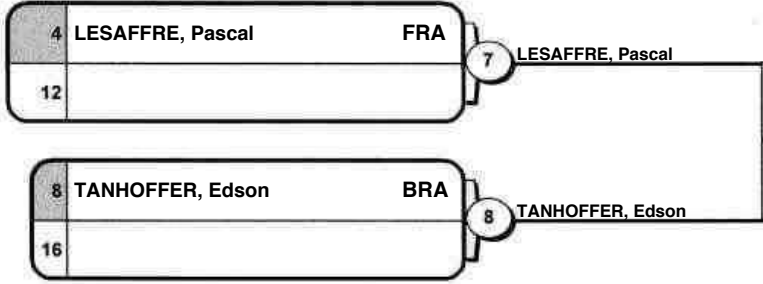

Results		
Résultat / Platzierungen		
1.	KOPPE, Hendrik	NED
2.	KALIKA, Eduard	USA
3.	LESAFFRE, Pascal	FRA
3.	HOLDER, Paul	USA
5.	GARRIGA, Javier	USA
5.	TANHOFFER, Edson	BRA
7.	TRABELSI, Miled	FRA
7.	BARS, Guido	GER

Repechage / Trostrunde

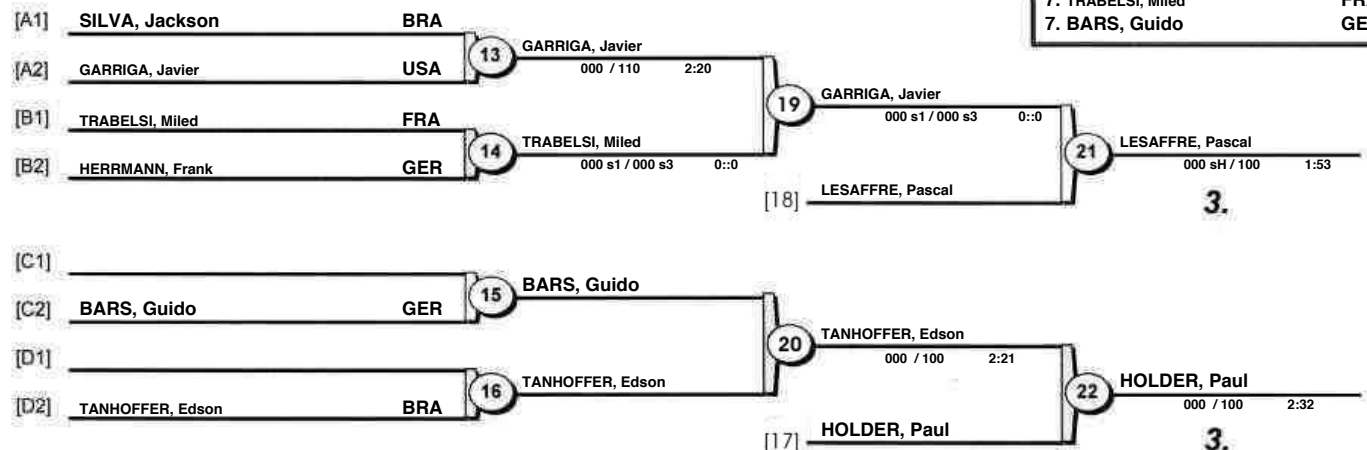



Veterans World Judo Championships 2016

(USA Fort Lauderdale, 18-21 November 2016)

M6 -60 kg

5 Judoka

			1	2	3	4	5		
1	MEREZHNIKOV, Andrey	RUS		0	0	1 (100)	1 (10)	2 (110)	
2	MELEKHIN, Sergey	RUS	1 (100)		0	1 (10)	0	2 (110)	
3	DANJOUX, Richard	FRA	1 (0.5)	1 (100)		1 (100)	0	3 (200.5)	
4	BOVA, Paul	USA	0	0	0		0	(0)	
5	HERSKOWITZ, Brian	USA	0	1 (1)	1 (100)	1 (100)		3 (201)	

1	MEREZHNIKOV, Andrey	RUS	1	MELEKHIN, Sergey	RUS
2	MELEKHIN, Sergey	RUS		000 s1 / 100 s1	1:17

3	DANJOUX, Richard	FRA	2	DANJOUX, Richard	FRA
4	BOVA, Paul	USA		100 s1 / 000	0:39

1	MEREZHNIKOV, Andrey	RUS	3	MEREZHNIKOV, Andrey	RUS
5	HERSKOWITZ, Brian	USA		010 / 000 s1	0::0

2	MELEKHIN, Sergey	RUS	4	DANJOUX, Richard	FRA
3	DANJOUX, Richard	FRA		000 / 100 s1	2:13

4	BOVA, Paul	USA	5	HERSKOWITZ, Brian	USA
5	HERSKOWITZ, Brian	USA		000 s1 / 101	1:54

1	MEREZHNIKOV, Andrey	RUS	6	DANJOUX, Richard	FRA
3	DANJOUX, Richard	FRA		000 s1 / 000	0::0

2	MELEKHIN, Sergey	RUS	7	MELEKHIN, Sergey	RUS
4	BOVA, Paul	USA		010 s2 / 000	0::0

3	DANJOUX, Richard	FRA	8	HERSKOWITZ, Brian	USA
5	HERSKOWITZ, Brian	USA		000 / 100	1:15

1	MEREZHNIKOV, Andrey	RUS	9	MEREZHNIKOV, Andrey	RUS
4	BOVA, Paul	USA		101 / 000	2::5

2	MELEKHIN, Sergey	RUS	10	HERSKOWITZ, Brian	USA
5	HERSKOWITZ, Brian	USA		000 s2 / 001	0::0

Final Results

1. HERSKOWITZ, Brian USA
2. DANJOUX, Richard FRA
3. MELEKHIN, Sergey RUS
- 3.



Veterans World Judo Championships 2016

(USA Fort Lauderdale, 18-21 November 2016)

M6 -66 kg

15 Judoka

POOL A

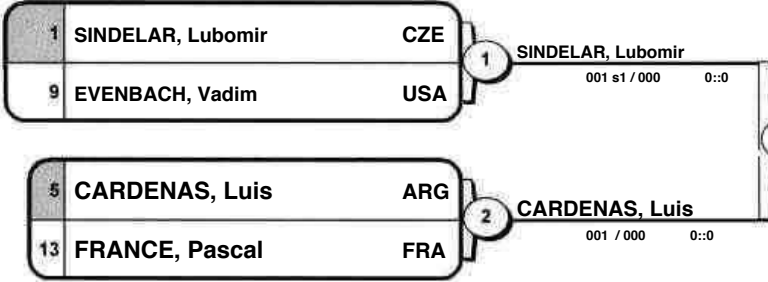

POOL B

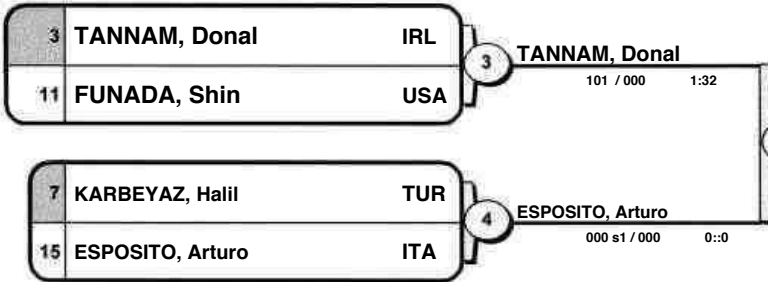

POOL C

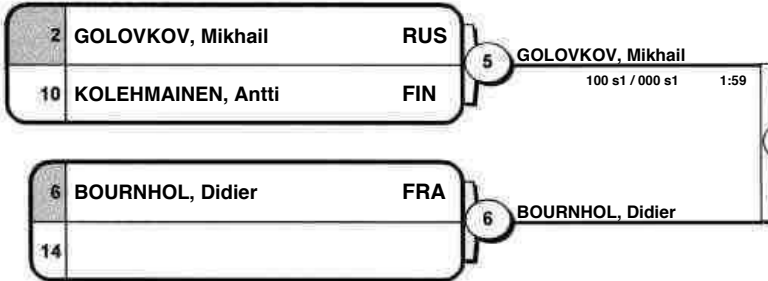

POOL D

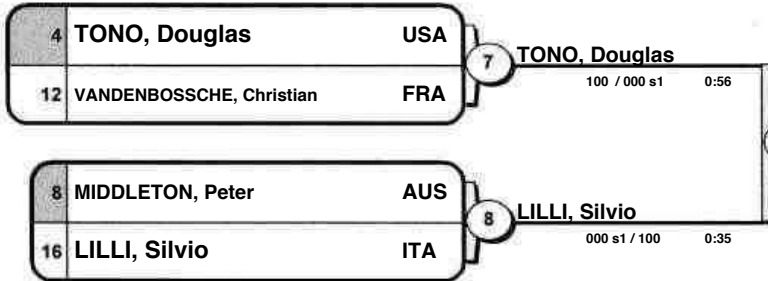

Results		
Résultat / Platzierungen		
1.	BOURNHOL, Didier	FRA
2.	ESPOSITO, Arturo	ITA
3.	TONO, Douglas	USA
3.	GOLOVKOV, Mikhail	RUS
5.	EVENBACH, Vadim	USA
5.	SINDELAR, Lubomir	CZE
7.	KARBAYAZ, Halil	TUR
7.	LILLI, Silvio	ITA

Repechage / Trostrunde

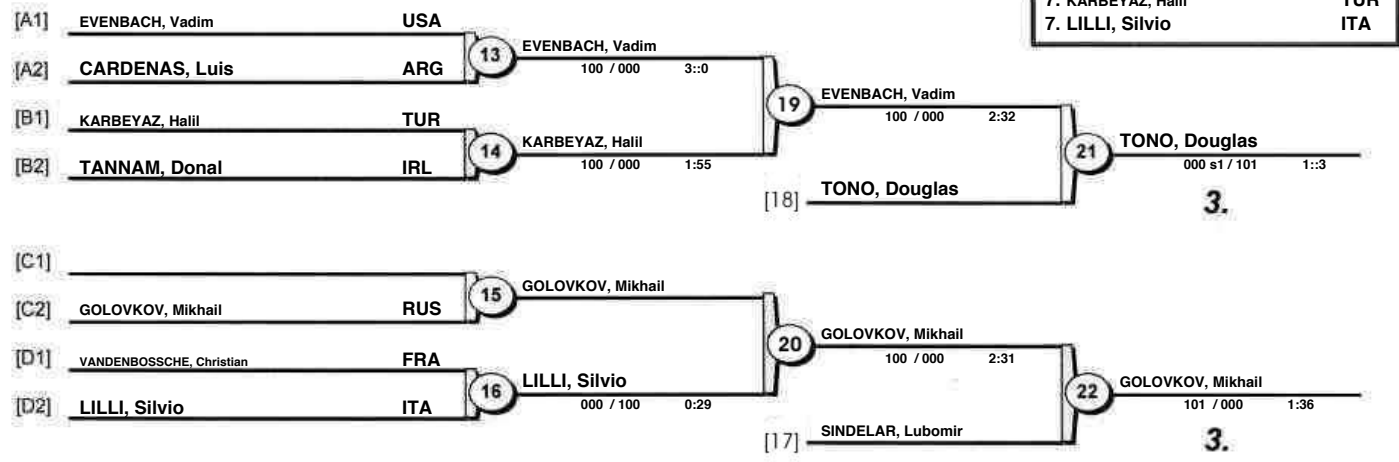



Veterans World Judo Championships 2016

(USA Fort Lauderdale, 18-21 November 2016)

M6 -73 kg

23 Judoka

POOL A



POOL B

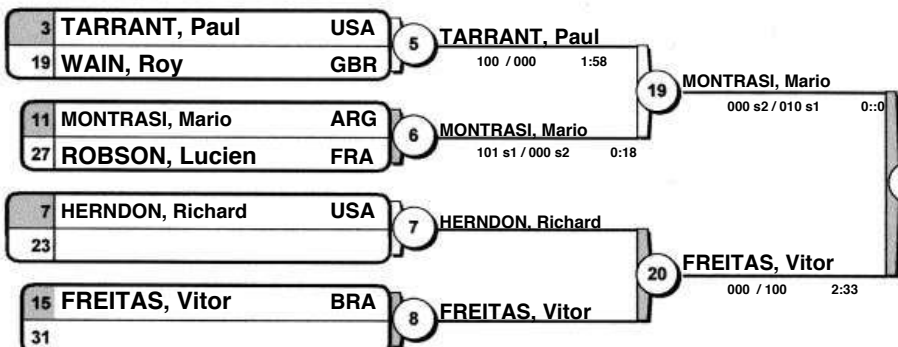

POOL C

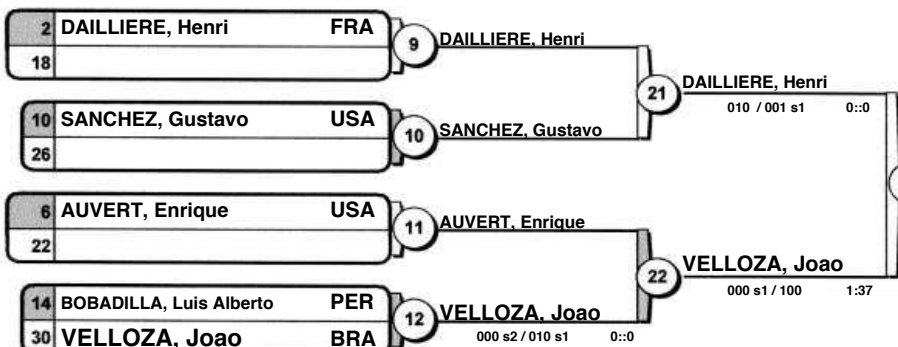

POOL D



1.

Results Résultat / Platzierungen

1. VASIAGIN, Evgenii RUS
2. DAILLIERE, Henri FRA
3. GHIRINGHELLI, Franco ITA
5. DIEDAT, Damien FRA
5. MONTRASI, Mario ARG
7. FREITAS, Vitor BRA
7. FUNGK, Harald GER

Repechage / Trostrunde

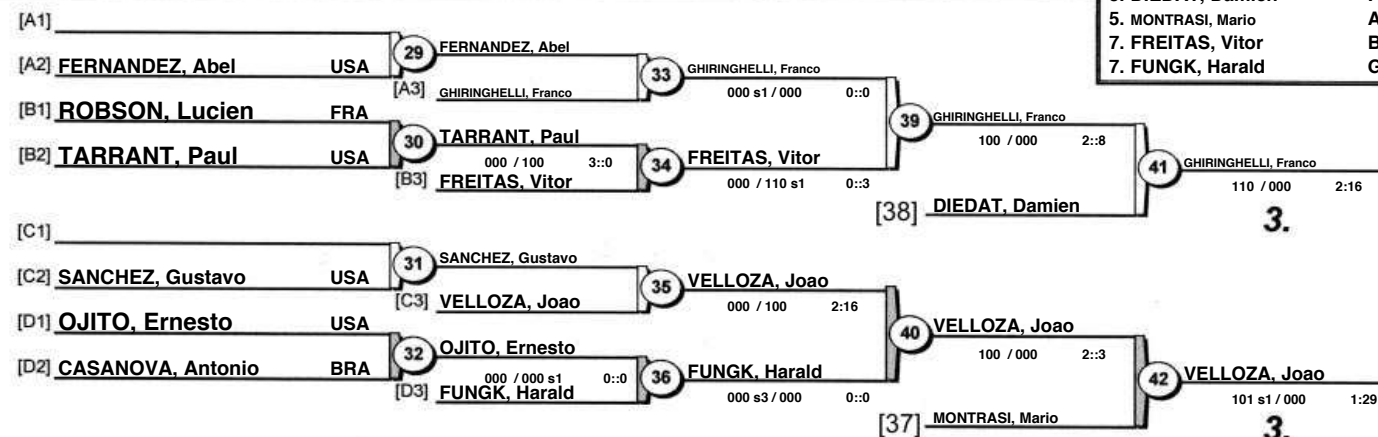



Veterans World Judo Championships 2016

(USA Fort Lauderdale, 18-21 November 2016)

M6 -81 kg

20 Judoka

POOL A

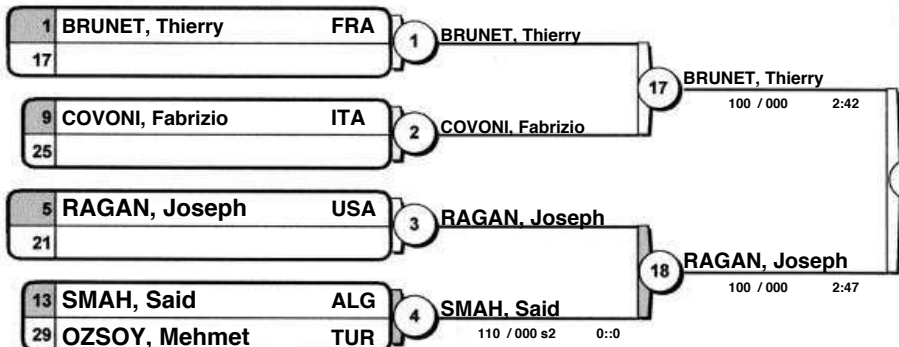

Pool A - Winner
Vainqueur / Sieger

POOL B

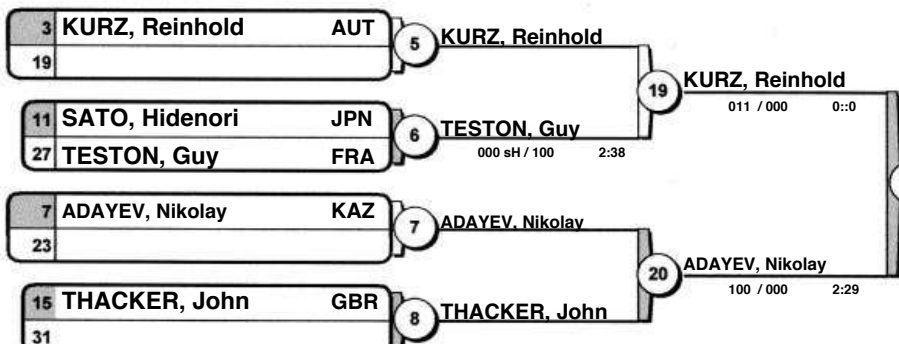

Pool B - Winner
Vainqueur / Sieger

POOL C

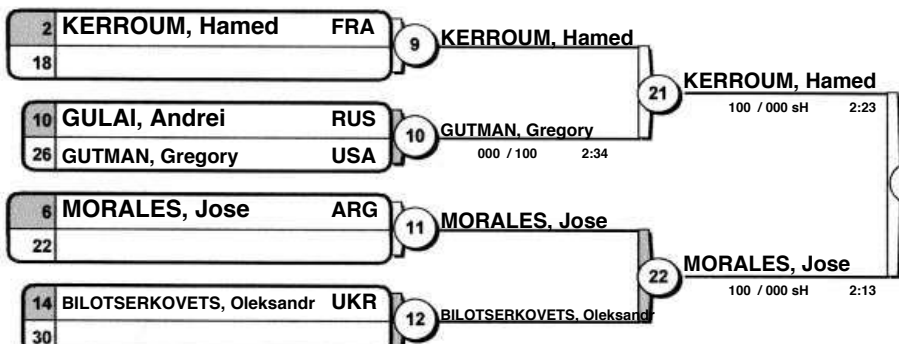

Pool C - Winner
Vainqueur / Sieger

POOL D



Pool D - Winner
Vainqueur / Sieger



1.



Results	
Résultat / Platzierungen	
1.	TUERO, Ricardo USA
2.	KURZ, Reinhold AUT
3.	KERROUM, Hamed FRA
3.	BRUNET, Thierry FRA
5.	COVONI, Fabrizio ITA
5.	AGRON, Francois FRA
7.	ADAYEV, Nikolay KAZ
7.	MORALES, Jose ARG

Repechage / Trostrunde

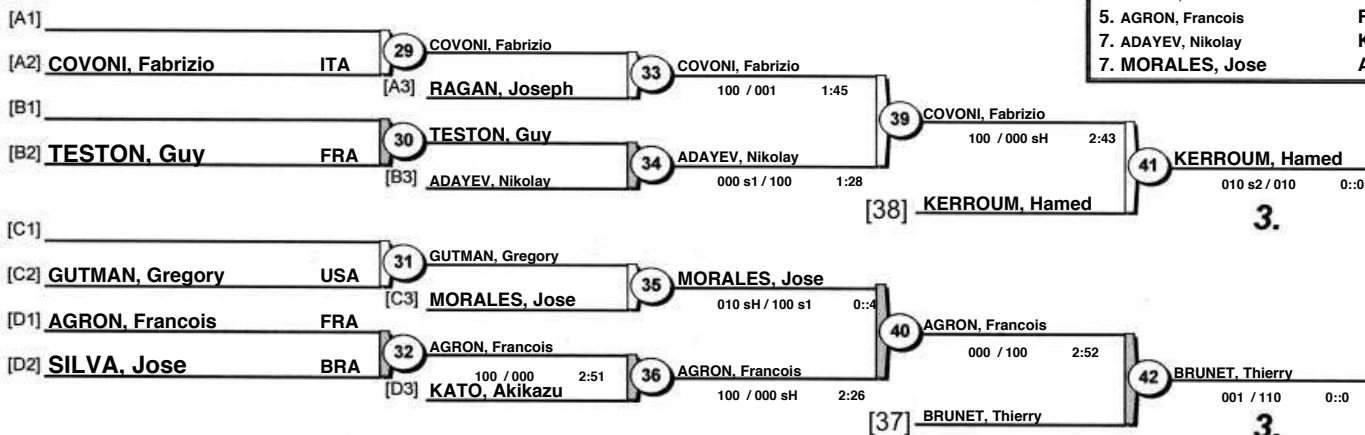

[38] KERROUM, Hamed

3.

[37] BRUNET, Thierry

3.



Veterans World Judo Championships 2016

(USA Fort Lauderdale, 18-21 November 2016)

M6 -90 kg

12 Judoka

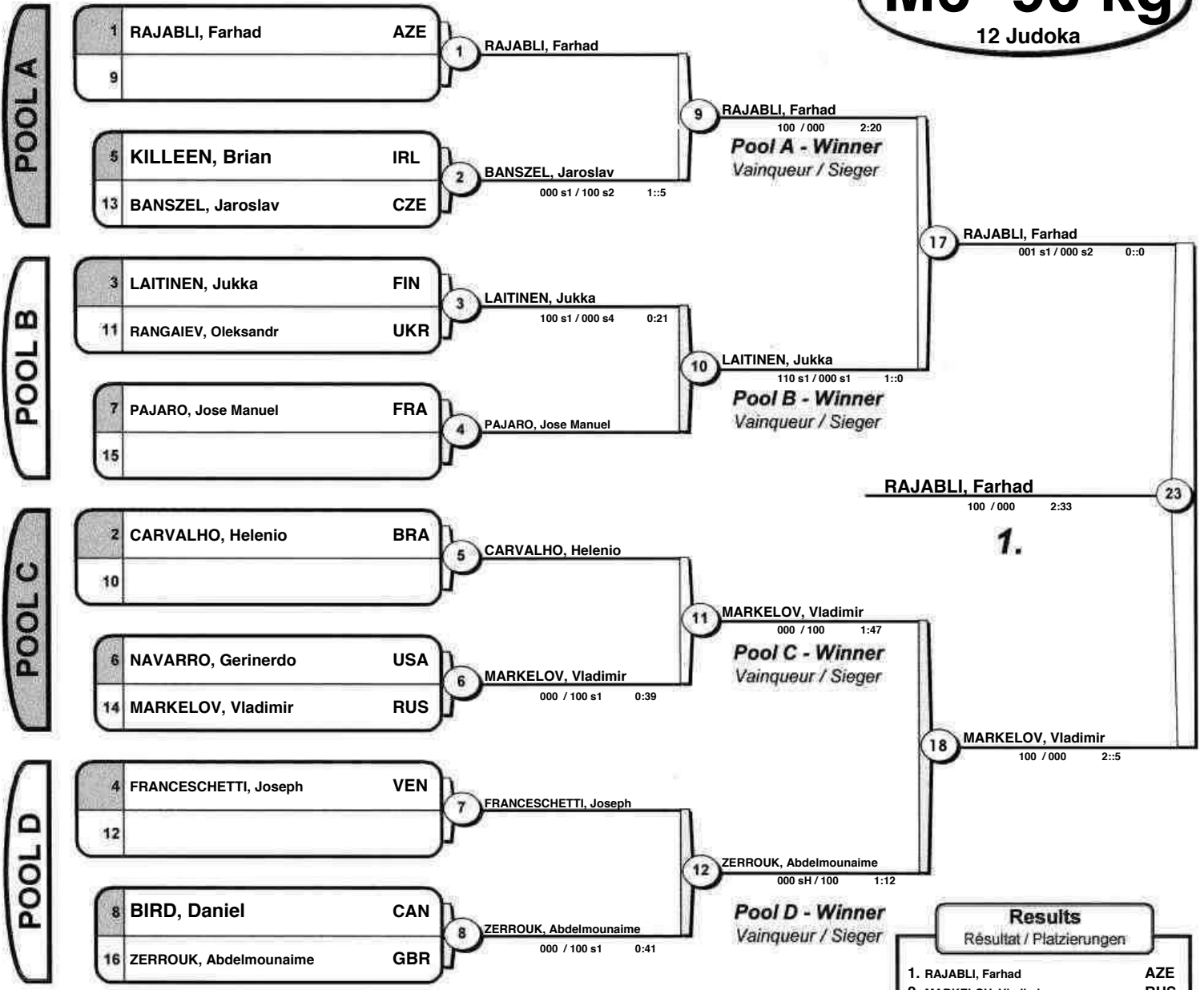

Results	
Résultat / Platzierungen	
1.	RAJABLI, Farhad (AZE)
2.	MARKELOV, Vladimir (RUS)
3.	BANSZEL, Jaroslav (CZE)
4.	LAITINEN, Jukka (FIN)
5.	ZERROUK, Abdelmounaime (GBR)
6.	BIRD, Daniel (CAN)
7.	PAJARO, Jose Manuel (FRA)
8.	NAVARRO, Gerineldo (USA)

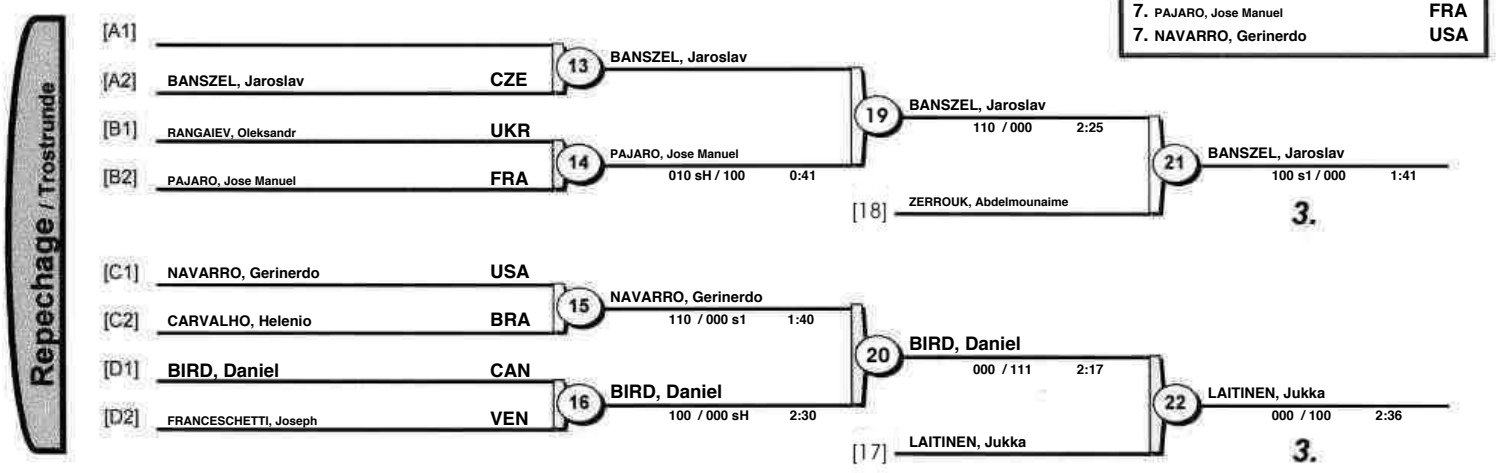



Veterans World Judo Championships 2016

(USA Fort Lauderdale, 18-21 November 2016)

M6 -100 kg

15 Judoka

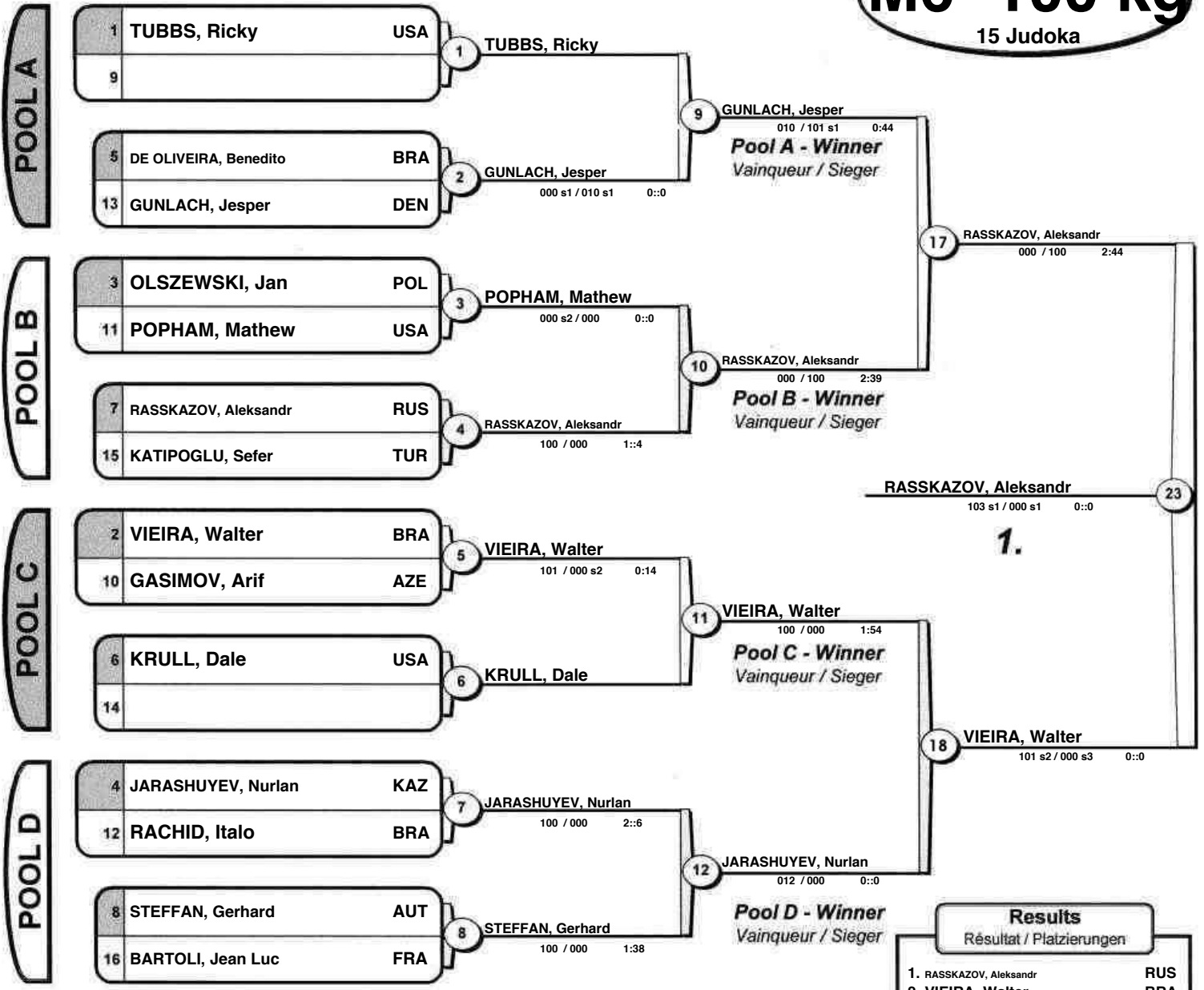

Results		
Résultat / Platzierungen		
1.	RASSKAZOV, Aleksandr	RUS
2.	VIEIRA, Walter	BRA
3.	JARASHUYEV, Nurlan	KAZ
3.	GUNLACH, Jesper	DEN
5.	DE OLIVEIRA, Benedito	BRA
5.	GASIMOV, Arif	AZE
7.	KATIPOGLU, Sefer	TUR
7.	RACHID, Italo	BRA

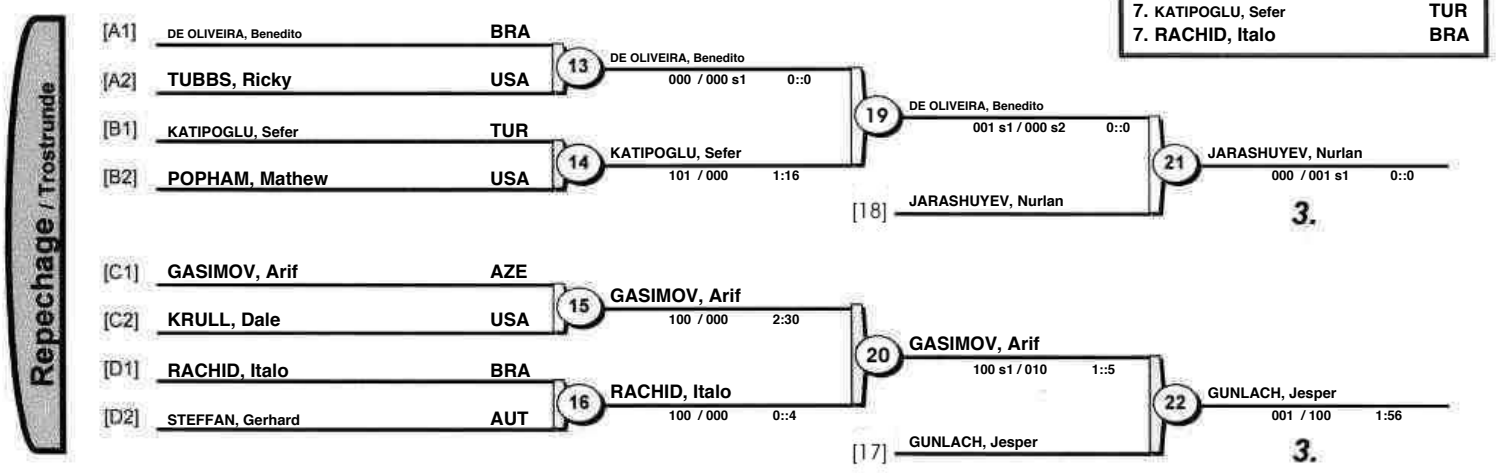



Veterans World Judo Championships 2016

(USA Fort Lauderdale, 18-21 November 2016)

M6 +100 kg

9 Judoka

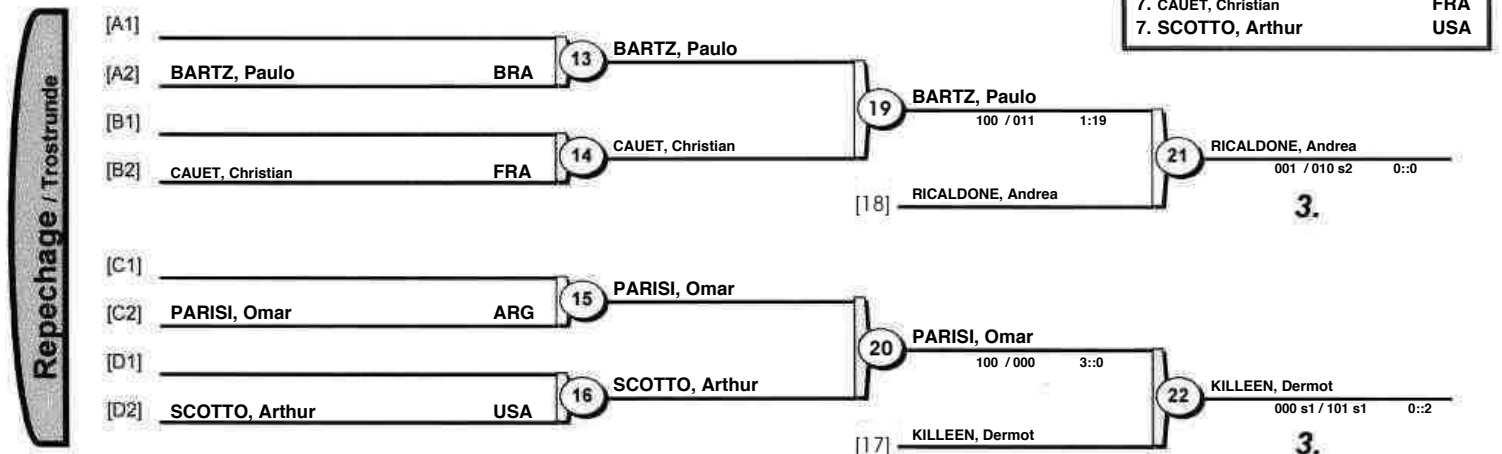
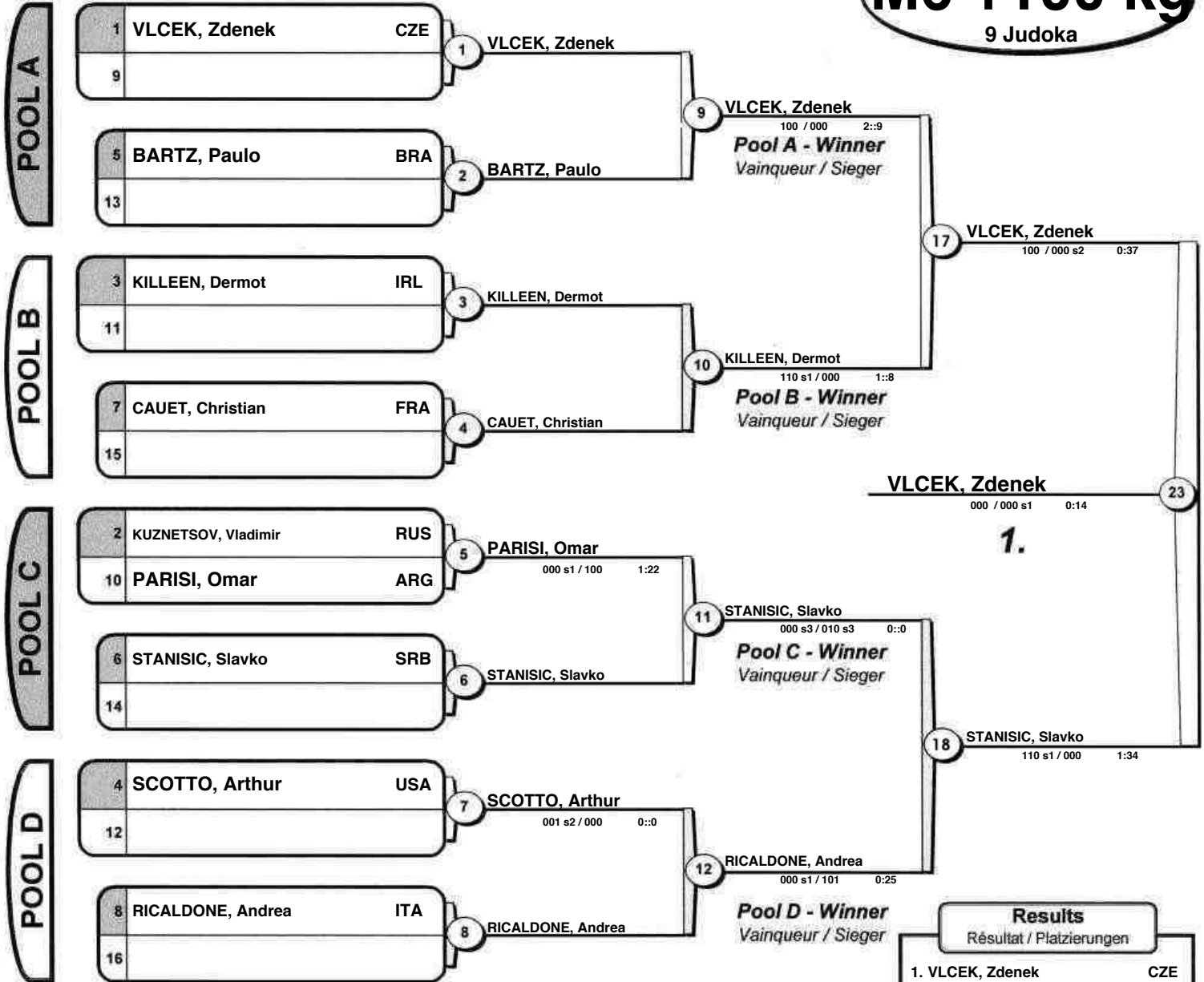



Veterans World Judo Championships 2016

(USA Fort Lauderdale, 18-21 November 2016)

M7 -60 kg

5 Judoka

			1	2	3	4	5		
1	VICENTE RAMOS, Julio	ESP		1 (1)	1 (1)	1 (100)	1 (100)	4 (202)	
2	NGUYEN, Phuc	USA	0		1 (100)	1 (100)	0	2 (200)	
3	SAUNDERS, James	USA	0	0		0	0	(0)	
4	HONDA, Sergio	BRA	0	0	1 (1)		1 (100)	2 (101)	
5	STENLUND, Benny	SWE	0	1 (1)	1 (100)	0		2 (101)	

1	VICENTE RAMOS, Julio	ESP	①	VICENTE RAMOS, Julio	ESP
2	NGUYEN, Phuc	USA		001 / 000 s1	0::0

3	SAUNDERS, James	USA	②	HONDA, Sergio	BRA
4	HONDA, Sergio	BRA		000 / 001	0::0

1	VICENTE RAMOS, Julio	ESP	③	VICENTE RAMOS, Julio	ESP
5	STENLUND, Benny	SWE		100 / 001	0:57

2	NGUYEN, Phuc	USA	④	NGUYEN, Phuc	USA
3	SAUNDERS, James	USA		100 s1 / 000	0:52

4	HONDA, Sergio	BRA	⑤	HONDA, Sergio	BRA
5	STENLUND, Benny	SWE		100 / 000	1:54

1	VICENTE RAMOS, Julio	ESP	⑥	VICENTE RAMOS, Julio	ESP
3	SAUNDERS, James	USA		011 / 010	0::0

2	NGUYEN, Phuc	USA	⑦	NGUYEN, Phuc	USA
4	HONDA, Sergio	BRA		000 / 100 s1	0::0

3	SAUNDERS, James	USA	⑧	STENLUND, Benny	SWE
5	STENLUND, Benny	SWE		000 / 110 s1	0::0

1	VICENTE RAMOS, Julio	ESP	⑨	VICENTE RAMOS, Julio	ESP
4	HONDA, Sergio	BRA		110 / 001	0:13

2	NGUYEN, Phuc	USA	⑩	STENLUND, Benny	SWE
5	STENLUND, Benny	SWE		000 s1 / 001 s1	0::0

Final Results

- VICENTE RAMOS, Julio ESP
- NGUYEN, Phuc USA
- HONDA, Sergio BRA
-



Veterans World Judo Championships 2016

(USA Fort Lauderdale, 18-21 November 2016)

M7 -66 kg

5 Judoka

			1	2	3	4	5		
1	OZDEMIR, Ahmet	TUR		1 (10)	0	1 (0.5)	1 (0.5)	3 (11)	
2	HUBER, Willy	GER	0		0	1 (100)	1 (10)	2 (110)	
3	NORTH, Sandy	USA	1 (100)	1 (100)		1 (1)	1 (100)	4 (301)	
4	ZUKROWSKI, Waldemar	POL	0	0	0		0	(0)	
5	BIGGS, Clive	GBR	0	0	0	1 (100)		1 (100)	

1	OZDEMIR, Ahmet	TUR	1	OZDEMIR, Ahmet		TUR
2	HUBER, Willy	GER		010 s3 / 000	0::0	

3	NORTH, Sandy	USA	2	NORTH, Sandy		USA
4	ZUKROWSKI, Waldemar	POL		001 s1 / 000	0::0	

1	OZDEMIR, Ahmet	TUR	3	OZDEMIR, Ahmet		TUR
5	BIGGS, Clive	GBR		000 / 000 s2	0::0	

2	HUBER, Willy	GER	4	NORTH, Sandy		USA
3	NORTH, Sandy	USA		000 / 100	2:14	

4	ZUKROWSKI, Waldemar	POL	5	BIGGS, Clive		GBR
5	BIGGS, Clive	GBR		000 s1 / 100	0:53	

1	OZDEMIR, Ahmet	TUR	6	NORTH, Sandy		USA
3	NORTH, Sandy	USA		000 / 100	0::0	

2	HUBER, Willy	GER	7	HUBER, Willy		GER
4	ZUKROWSKI, Waldemar	POL		110 s1 / 000 s2	1:20	

3	NORTH, Sandy	USA	8	NORTH, Sandy		USA
5	BIGGS, Clive	GBR		001 / 100 s3	0::0	

1	OZDEMIR, Ahmet	TUR	9	OZDEMIR, Ahmet		TUR
4	ZUKROWSKI, Waldemar	POL		100 / 100	2:30	

2	HUBER, Willy	GER	10	HUBER, Willy		GER
5	BIGGS, Clive	GBR		011 s1 / 000	0::0	

Final Results

1. NORTH, Sandy USA
2. OZDEMIR, Ahmet TUR
3. HUBER, Willy GER
- 3.



Veterans World Judo Championships 2016

(USA Fort Lauderdale, 18-21 November 2016)

M7 -73 kg

15 Judoka

POOL A

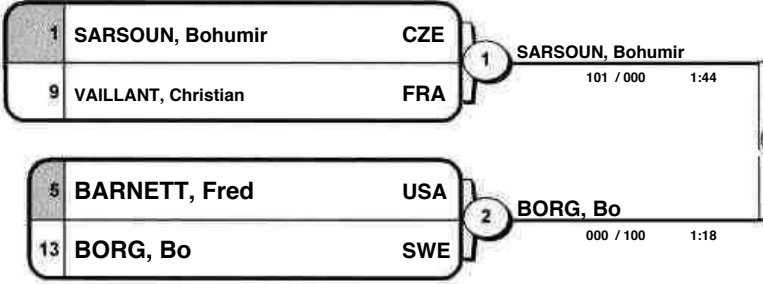

POOL B

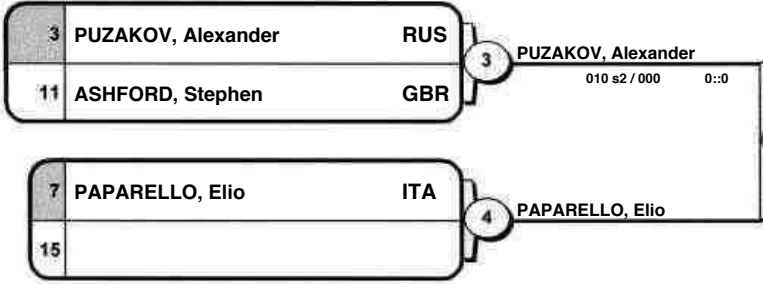

POOL C

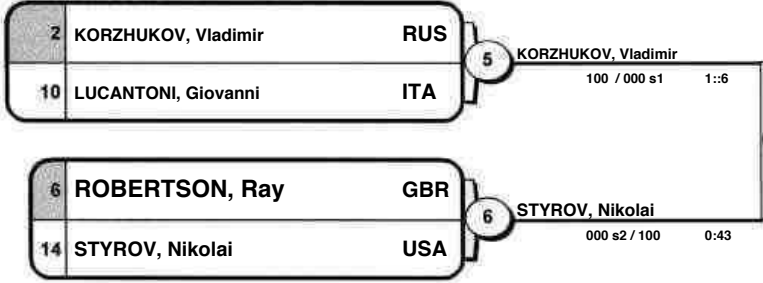

POOL D

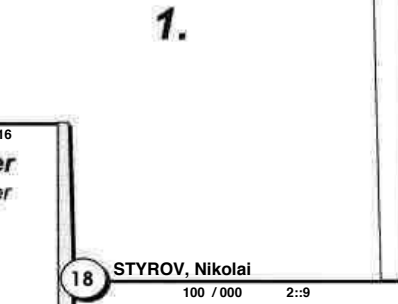
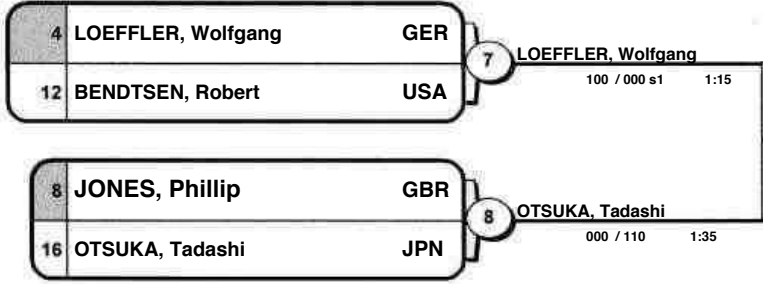

Results	
Résultat / Platzierungen	
1.	PAPARELLO, Elio ITA
2.	STYROV, Nikolai USA
3.	PUZAKOV, Alexander RUS
3.	SARSOUN, Bohumir CZE
5.	OTSUKA, Tadashi JPN
5.	KORZHUKOV, Vladimir RUS
7.	BORG, Bo SWE
7.	LOEFFLER, Wolfgang GER

Repechage / Trostrunde

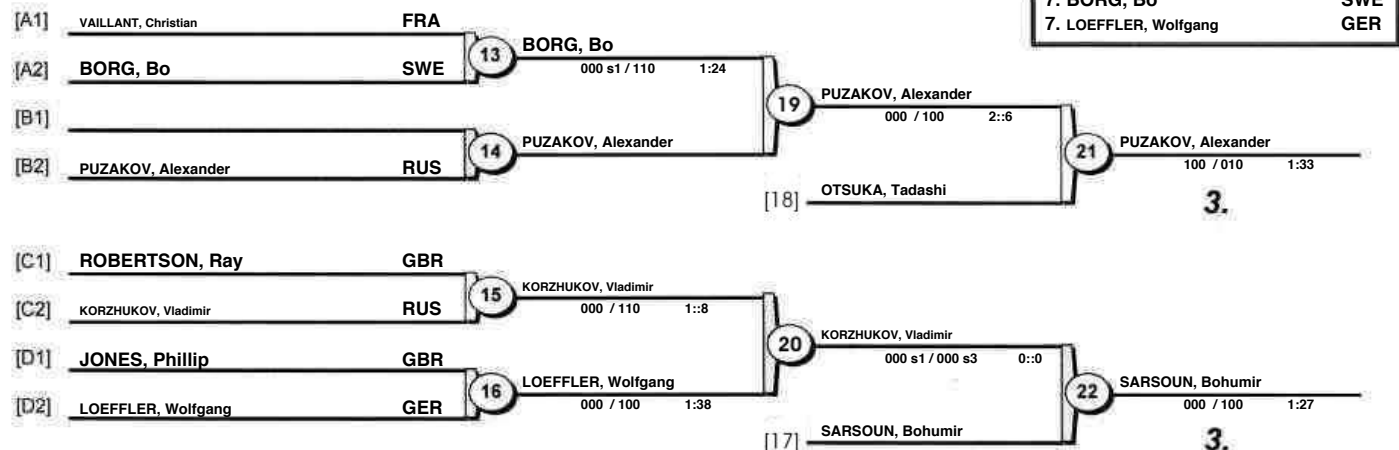



Veterans World Judo Championships 2016

(USA Fort Lauderdale, 18-21 November 2016)

M7 -81 kg

11 Judoka

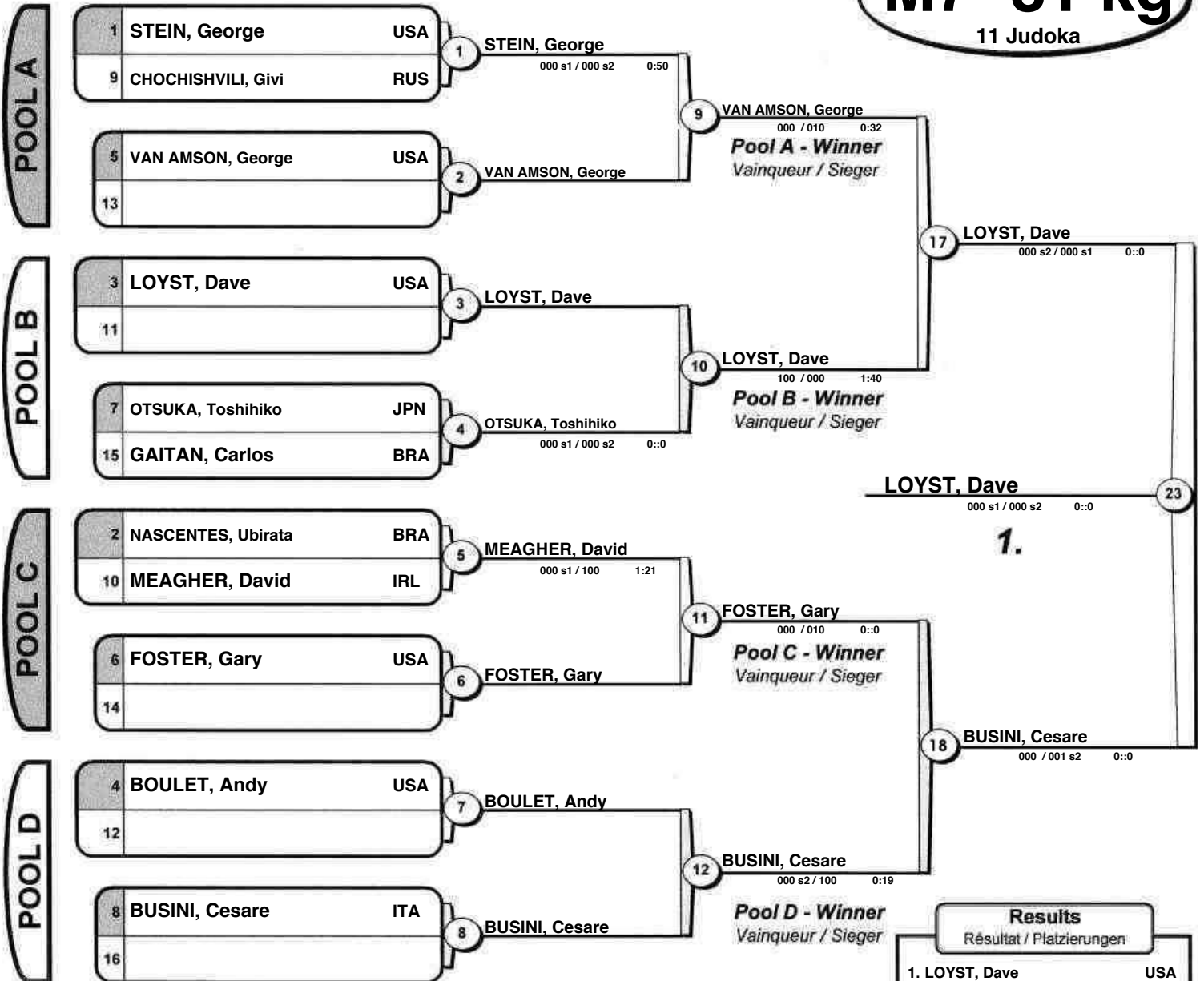

Results	
Résultat / Platzierungen	
1.	LOYST, Dave USA
2.	BUSINI, Cesare ITA
3.	FOSTER, Gary USA
3.	BOULET, Andy USA
5.	OTSUKA, Toshihiko JPN
5.	VAN AMSON, George USA
7.	STEIN, George USA
7.	MEAGHER, David IRL

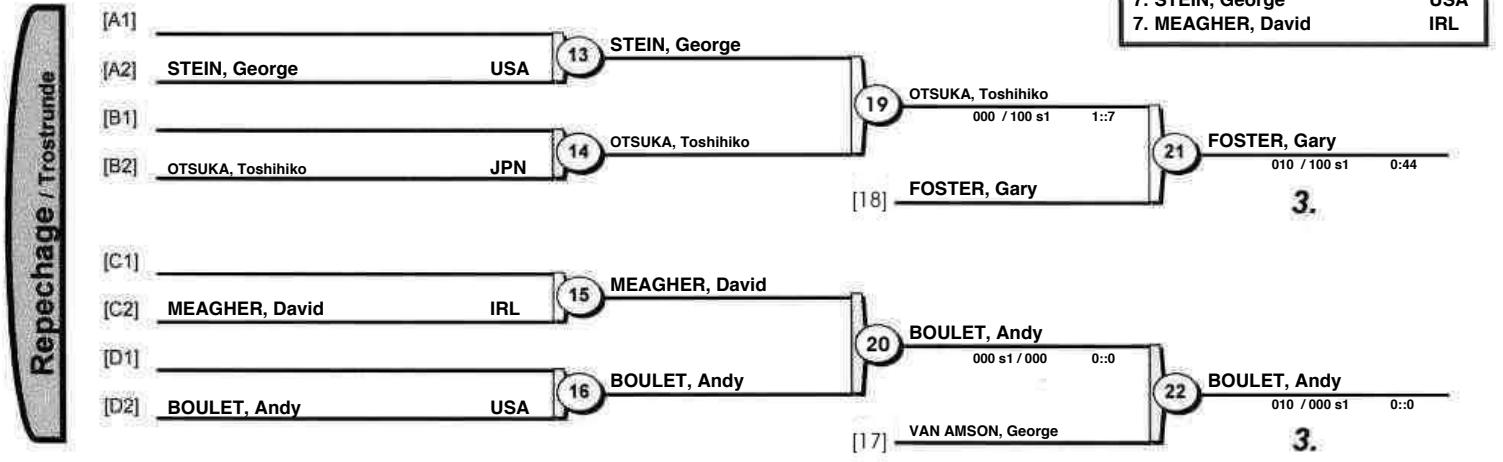



Veterans World Judo Championships 2016

(USA Fort Lauderdale, 18-21 November 2016)

M7 -90 kg

13 Judoka

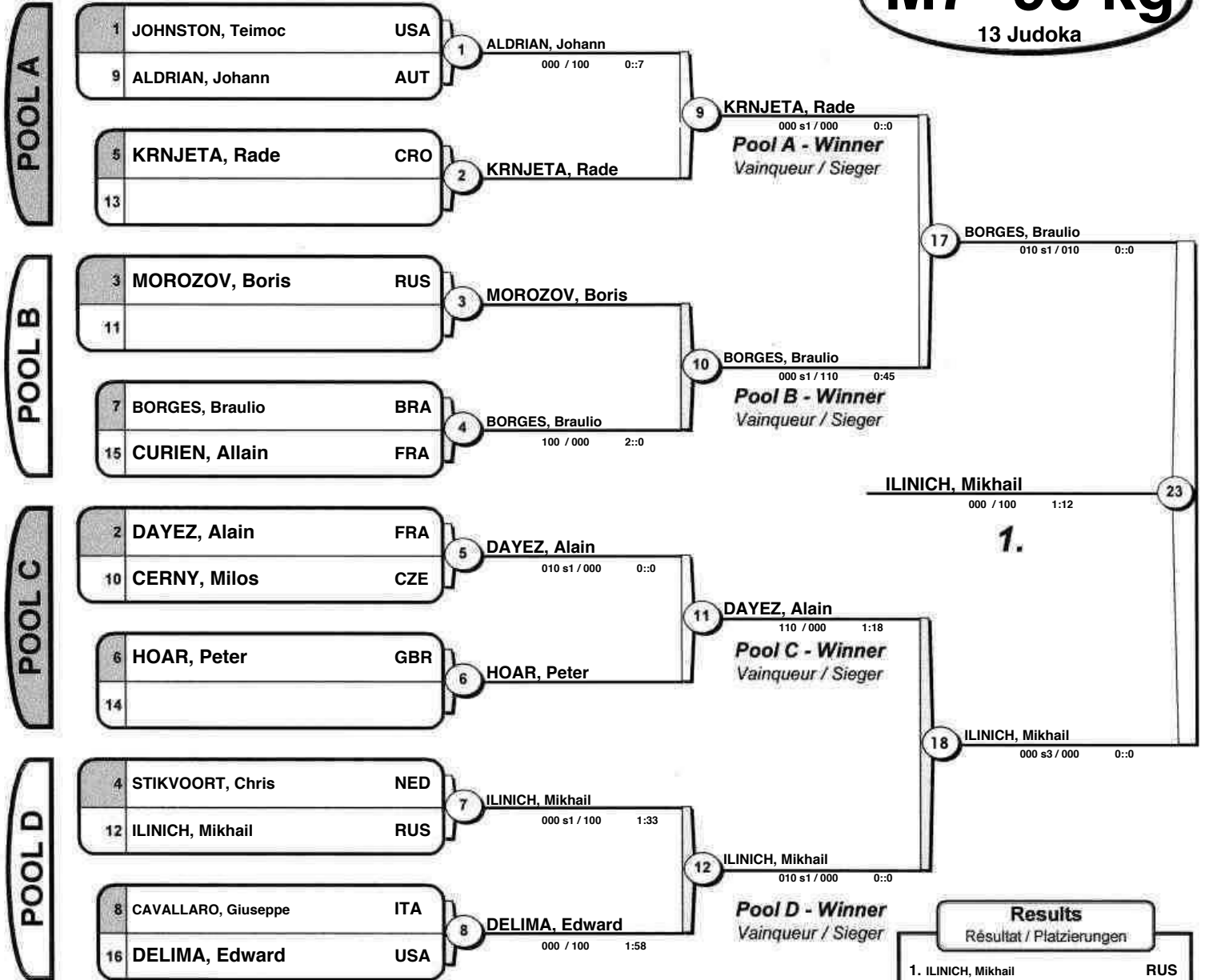

Results	
Résultat / Platzierungen	
1. ILINICH, Mikhail	RUS
2. BORGES, Braulio	BRA
3. ALDRIAN, Johann	AUT
3. KRNJETA, Rade	CRO
5. DAYEZ, Alain	FRA
5. HOAR, Peter	GBR
7. CURIEN, Allain	FRA
7. DELIMA, Edward	USA

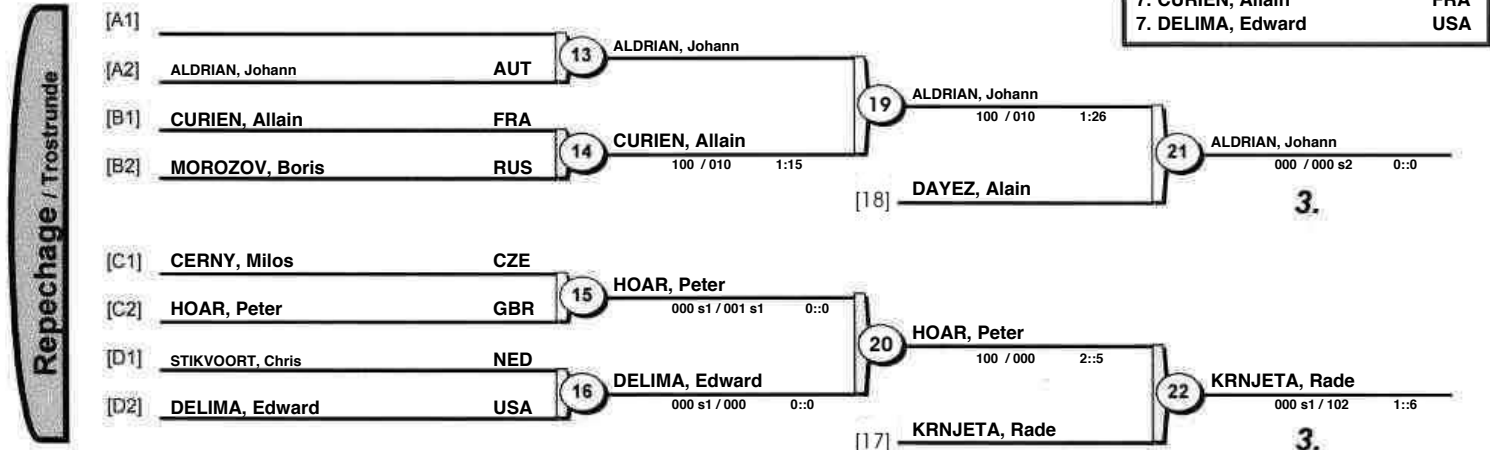



Veterans World Judo Championships 2016

(USA Fort Lauderdale, 18-21 November 2016)

M7 -100 kg

9 Judoka

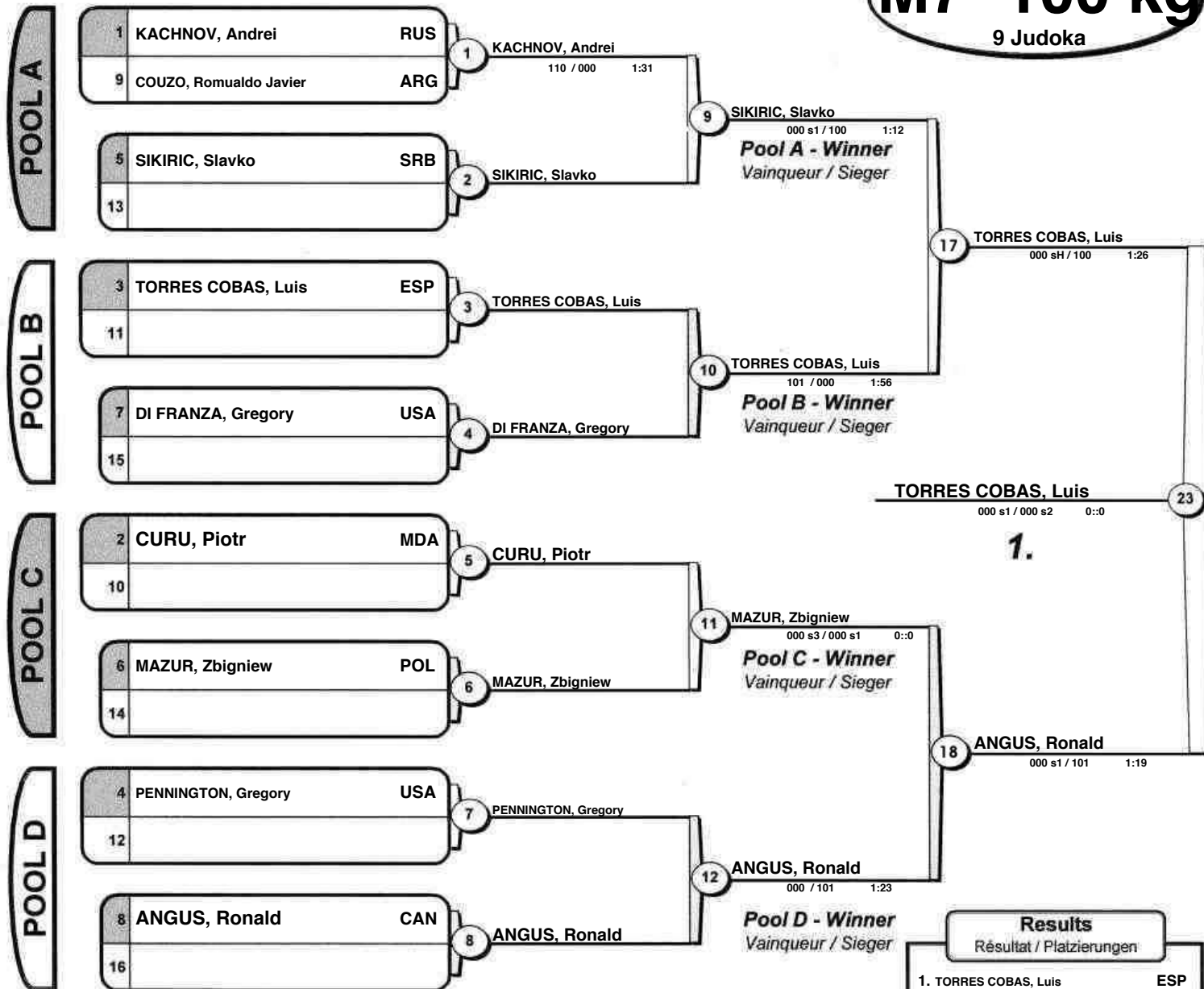

Results	
Résultat / Platzierungen	
1.	TORRES COBAS, Luis (ESP)
2.	ANGUS, Ronald (CAN)
3.	MAZUR, Zbigniew (POL)
3.	SIKIRIC, Slavko (SRB)
5.	DI FRANZA, Gregory (USA)
5.	CURU, Piotr (MDA)
7.	KACHNOV, Andrei (RUS)
7.	PENNINGTON, Gregory (USA)

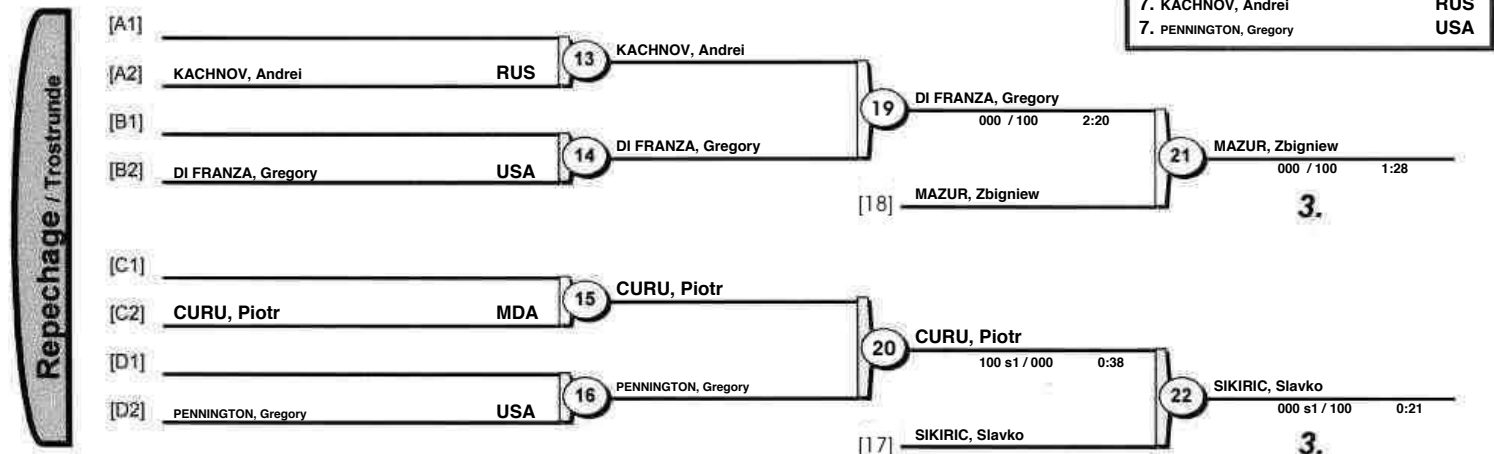



Veterans World Judo Championships 2016

(USA Fort Lauderdale, 18-21 November 2016)

M7 +100 kg

4 Judoka

			1	2	3	4			
1	KULESHOV, Serge	USA		1 (100)	1 (100)	1 (100)	3 (300)		
2	SCHALLER, Volkmar	GER	0		0	0	(0)		
3	SIMÕES FILHO, Oswaldo	BRA	0	1 (100)		0	1 (100)		
4	SHINJIKASHVILI, Giorgi	GEO	0	1 (100)	1 (100)		2 (200)		

1	KULESHOV, Serge	USA	1	KULESHOV, Serge	USA
2	SCHALLER, Volkmar	GER		100 / 000	2:11

3	SIMÕES FILHO, Oswaldo	BRA	2	SHINJIKASHVILI, Giorgi	GEO
4	SHINJIKASHVILI, Giorgi	GEO		000 s3 / 100 s2	0:47

1	KULESHOV, Serge	USA	3	KULESHOV, Serge	USA
3	SIMÕES FILHO, Oswaldo	BRA		100 s1 / 000	0:27

2	SCHALLER, Volkmar	GER	4	SHINJIKASHVILI, Giorgi	GEO
4	SHINJIKASHVILI, Giorgi	GEO		000 / 100	2::2

1	KULESHOV, Serge	USA	5	KULESHOV, Serge	USA
4	SHINJIKASHVILI, Giorgi	GEO		100 / 000	0:25

2	SCHALLER, Volkmar	GER	6	SIMÕES FILHO, Oswaldo	BRA
3	SIMÕES FILHO, Oswaldo	BRA		000 / 100 s2	0::4

Final Results

1. KULESHOV, Serge USA
2. SHINJIKASHVILI, Giorgi GEO
3. SIMÕES FILHO, Oswaldo BRA
- 3.



Veterans World Judo Championships 2016

(USA Fort Lauderdale, 18-21 November 2016)

M8 -66 kg

4 Judoka

			1	2	3	4			
1	CASTILLEJO, Francisco	ESP		0	1 (100)	1 (10)	2 (110)		
2	IBANEZ, Ralph	CAN	1 (1)		1 (100)	1 (100)	3 (201)		
3	PAHLMAN, Tom	FIN	0	0		0	(0)		
4	POTSCHUVAY, Bruno	GER	0	0	1 (100)		1 (100)		

1	CASTILLEJO, Francisco	ESP	①	IBANEZ, Ralph	CAN
2	IBANEZ, Ralph	CAN		000 / 001	0::0

3	PAHLMAN, Tom	FIN	②	POTSCHUVAY, Bruno	GER
4	POTSCHUVAY, Bruno	GER		000 sH / 100	1:47

1	CASTILLEJO, Francisco	ESP	③	CASTILLEJO, Francisco	ESP
3	PAHLMAN, Tom	FIN		100 / 000	2::9

2	IBANEZ, Ralph	CAN	④	IBANEZ, Ralph	CAN
4	POTSCHUVAY, Bruno	GER		100 / 000	0:42

1	CASTILLEJO, Francisco	ESP	⑤	CASTILLEJO, Francisco	ESP
4	POTSCHUVAY, Bruno	GER		010 / 000 s2	0::0

2	IBANEZ, Ralph	CAN	⑥	IBANEZ, Ralph	CAN
3	PAHLMAN, Tom	FIN		100 / 000	1:28

Final Results

1. IBANEZ, Ralph CAN
2. CASTILLEJO, Francisco ESP
3. POTSCHUVAY, Bruno GER
- 3.



Veterans World Judo Championships 2016

(USA Fort Lauderdale, 18-21 November 2016)

M8 -73 kg

9 Judoka

POOL A

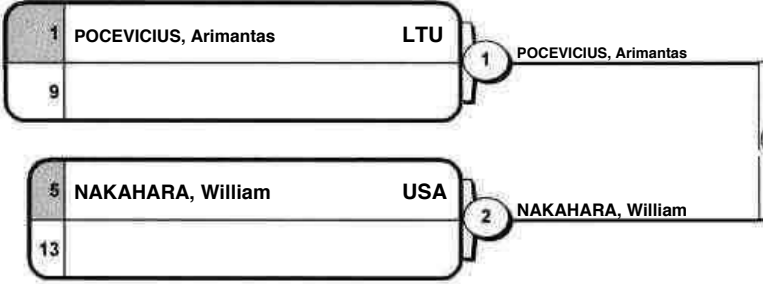

POOL B

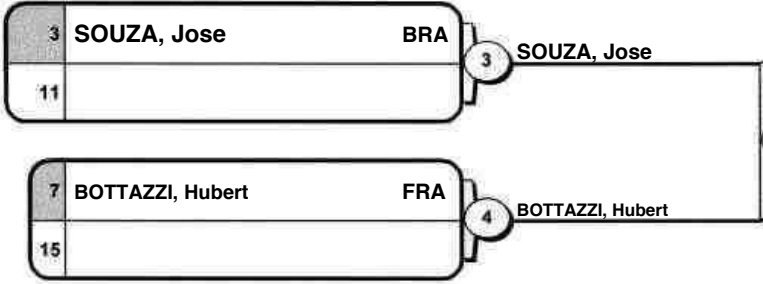

POOL C

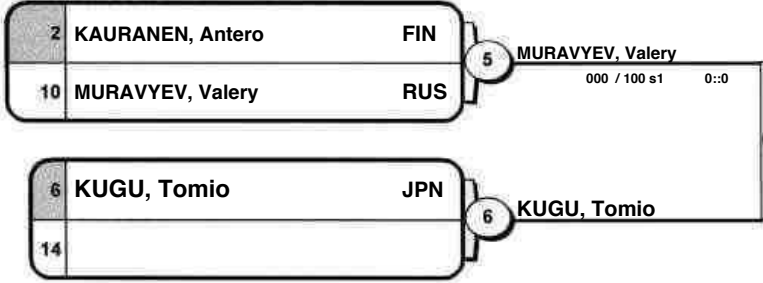

POOL D

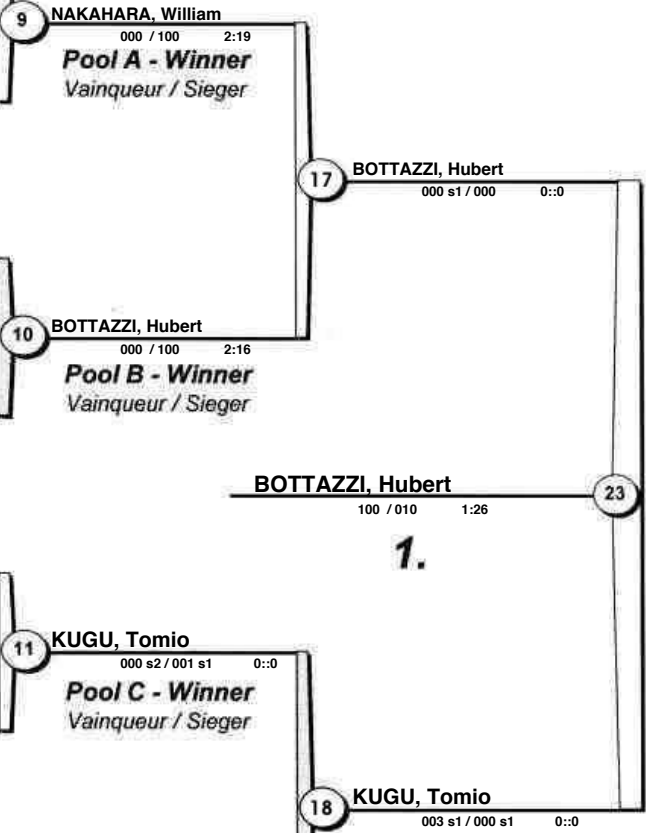
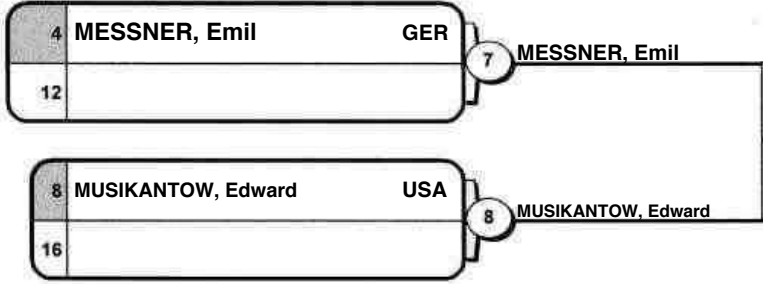

BOTTAZZI, Hubert

100 / 010 1:26

1.

Results	
Résultat / Platzierungen	
1. BOTTAZZI, Hubert	FRA
2. KUGU, Tomio	JPN
3. MESSNER, Emil	GER
3. MURAVYEV, Valery	RUS
5. SOUZA, Jose	BRA
5. NAKAHARA, William	USA
7. POCEVICIUS, Arimantas	LTU
7. MUSIKANTOW, Edward	USA

Repechage / Trostrunde

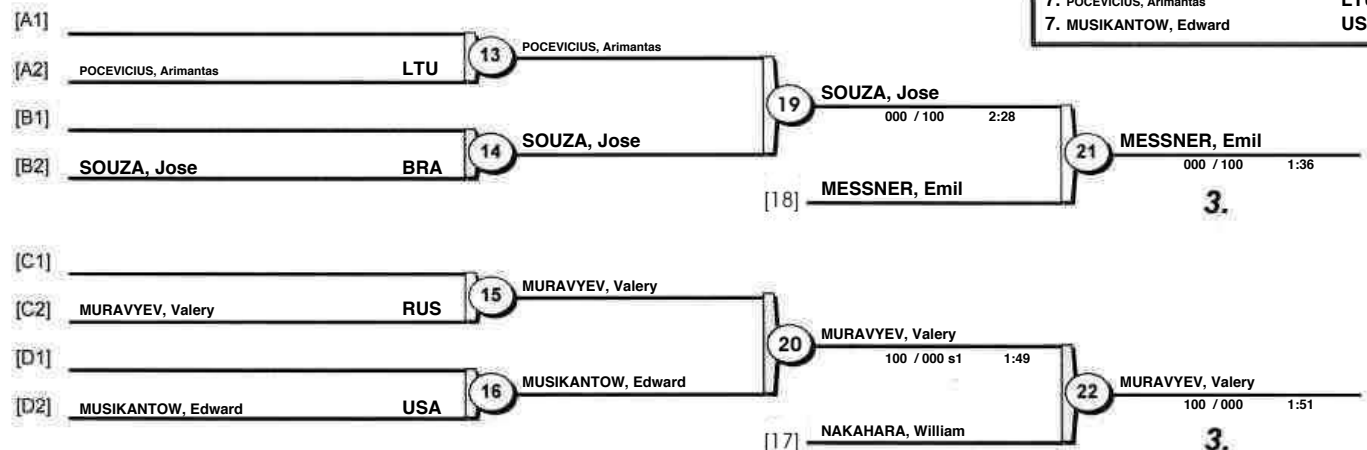



Veterans World Judo Championships 2016

(USA Fort Lauderdale, 18-21 November 2016)

M8 -81 kg

7 Judoka

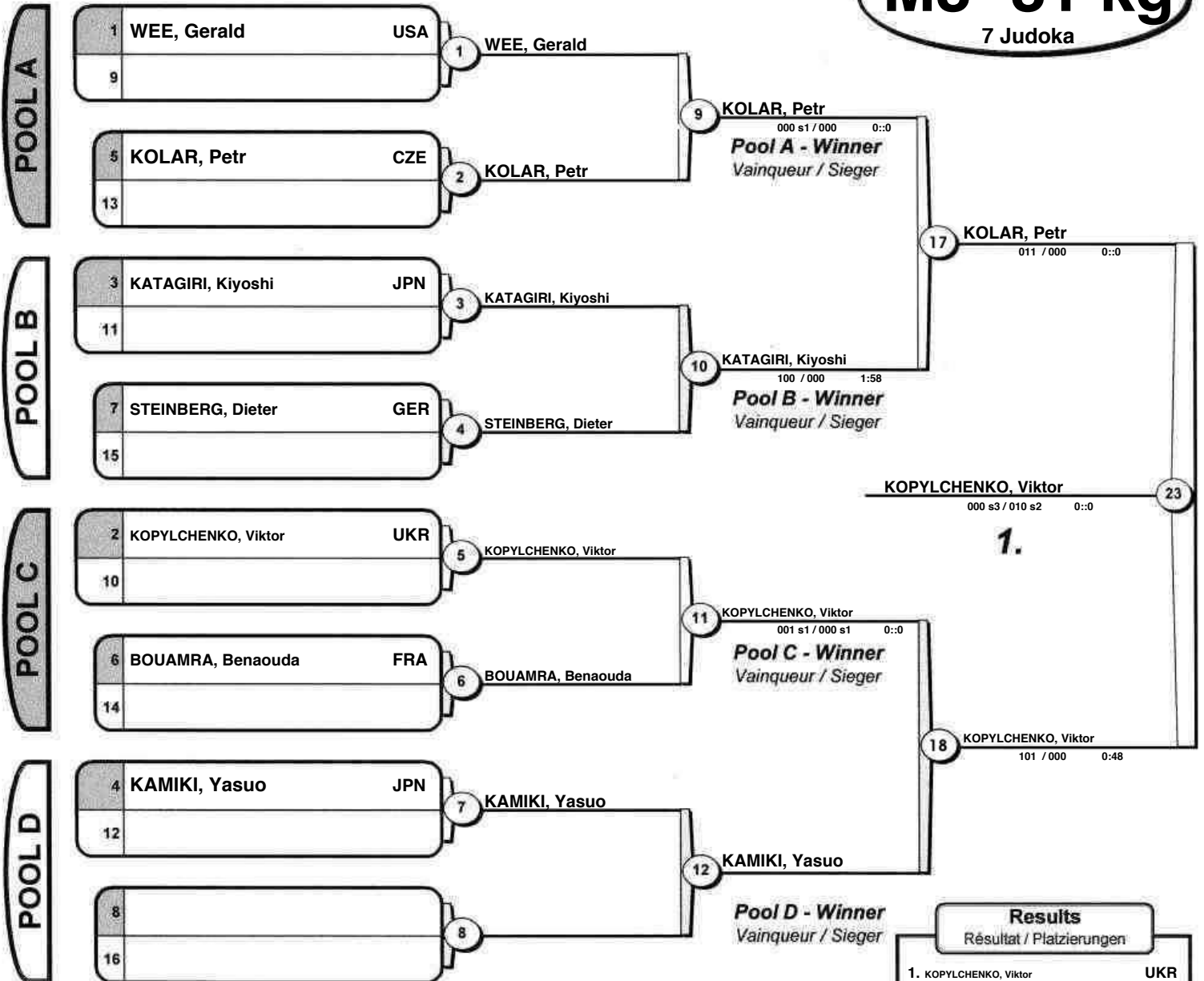

Results	
Résultat / Platzierungen	
1.	KOPYLCHENKO, Viktor UKR
2.	KOLAR, Petr CZE
3.	STEINBERG, Dieter GER
3.	KATAGIRI, Kiyoshi JPN
5.	KAMIKI, Yasuo JPN
5.	BOUAMRA, Benaouda FRA
7.	WEE, Gerald USA
7.	

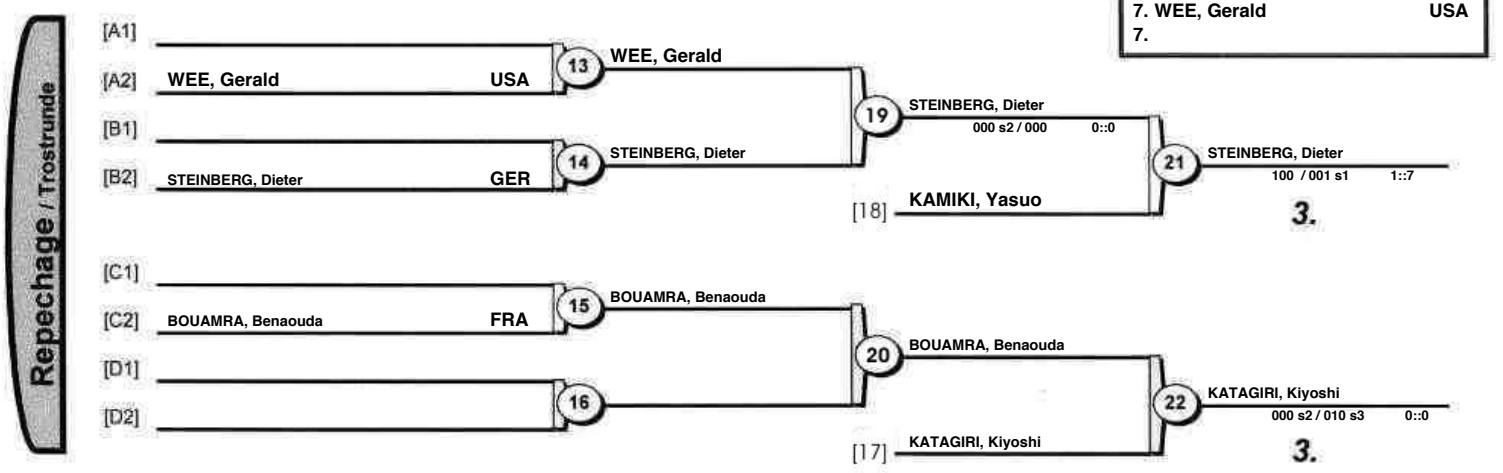



Veterans World Judo Championships 2016

(USA Fort Lauderdale, 18-21 November 2016)

M8 -90 kg

6 Judoka

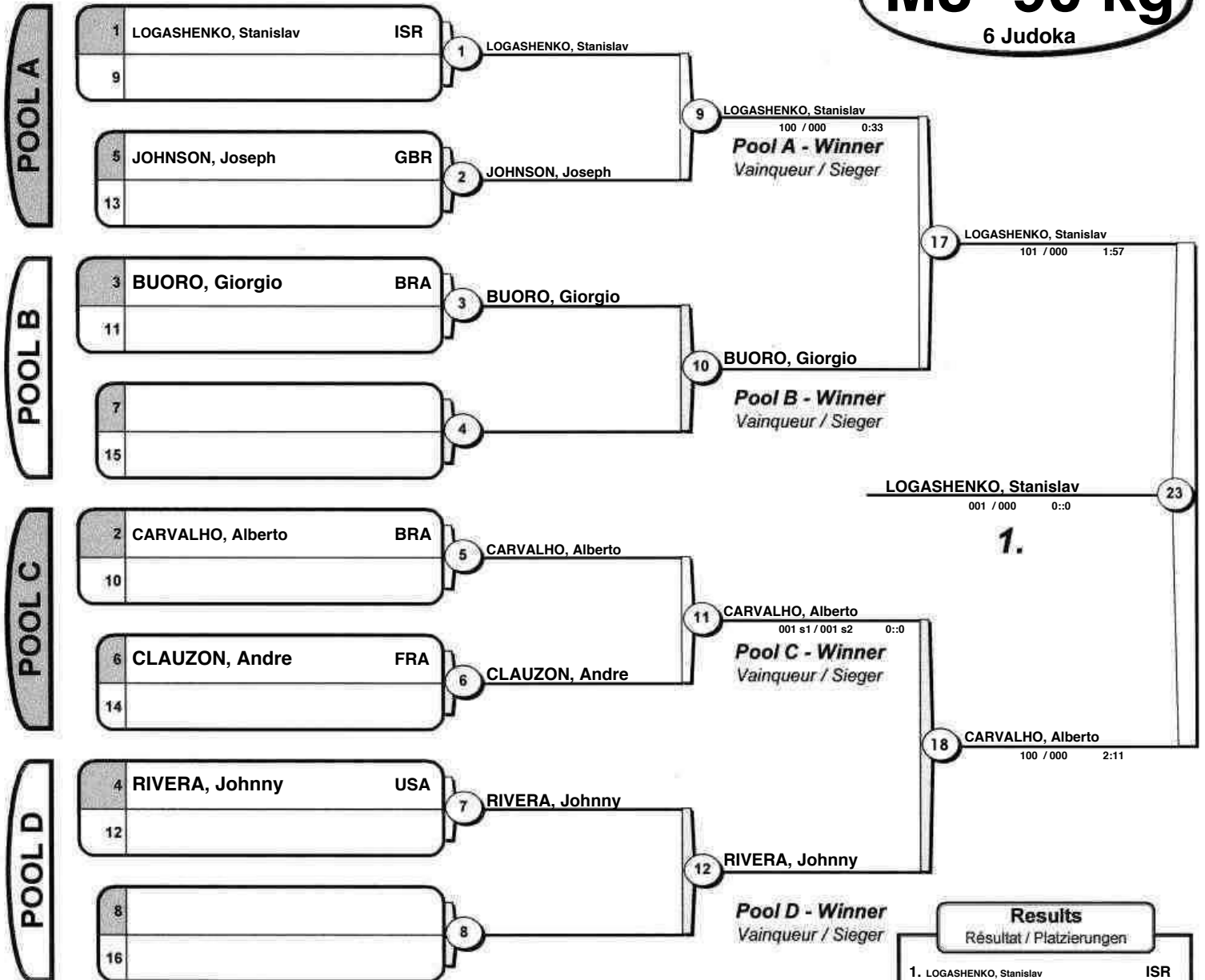

Results	
Résultat / Platzierungen	
1.	LOGASHENKO, Stanislav ISR
2.	CARVALHO, Alberto BRA
3.	JOHNSON, Joseph GBR
3.	CLAUZON, Andre FRA
5.	RIVERA, Johnny USA
5.	BUORO, Giorgio BRA
7.	
7.	

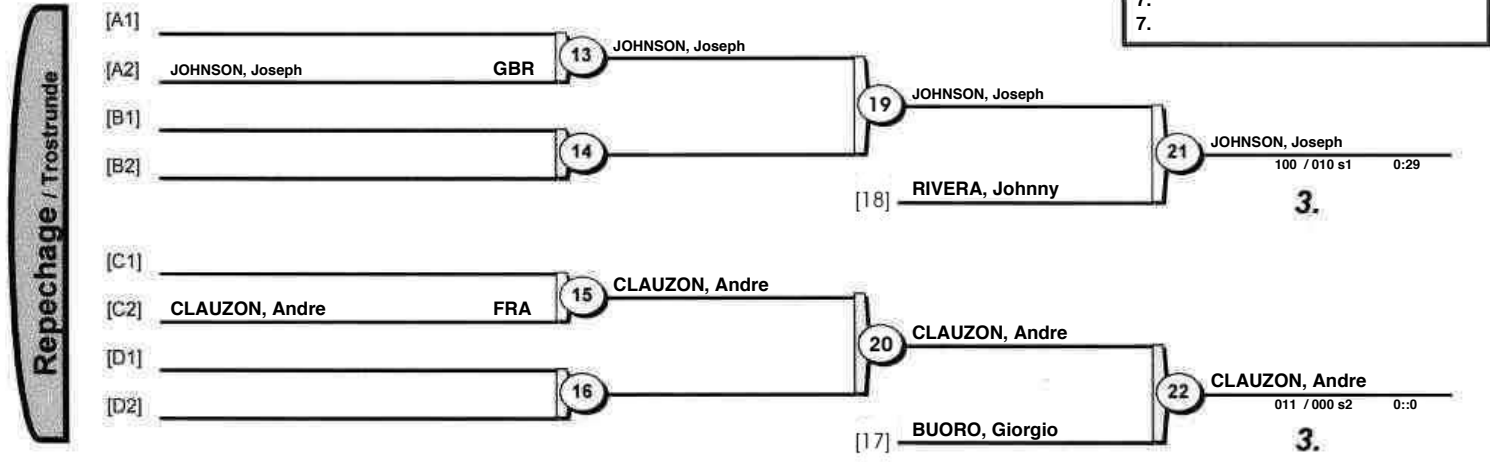



Veterans World Judo Championships 2016

(USA Fort Lauderdale, 18-21 November 2016)

M8 -100 kg

8 Judoka

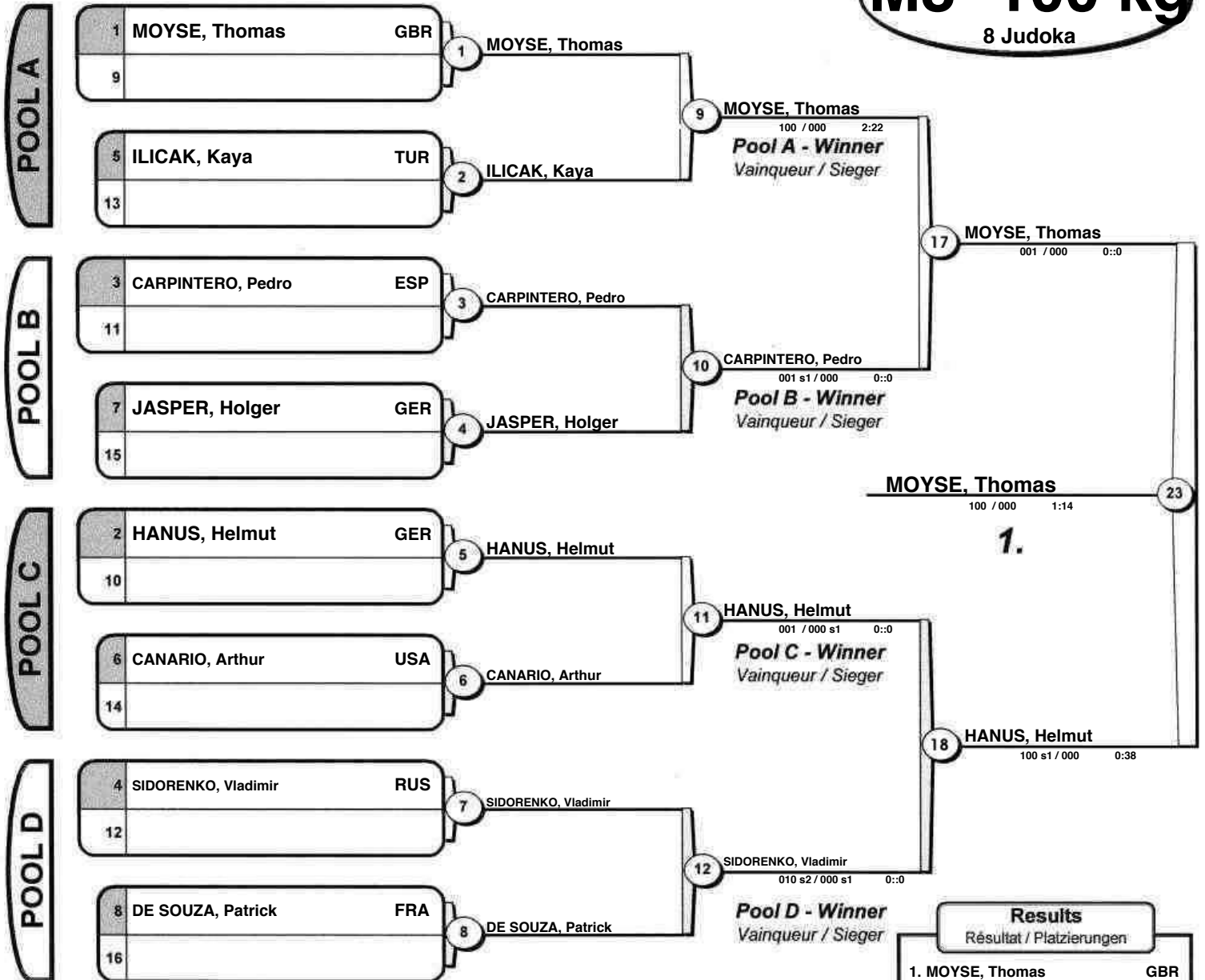

Results		
Résultat / Platzierungen		
1.	MOYSE, Thomas	GBR
2.	HANUS, Helmut	GER
3.	SIDORENKO, Vladimir	RUS
3.	DE SOUZA, Patrick	FRA
5.	JASPER, Holger	GER
5.	CARPINTERO, Pedro	ESP
7.	ILICAK, Kaya	TUR
7.	CANARIO, Arthur	USA

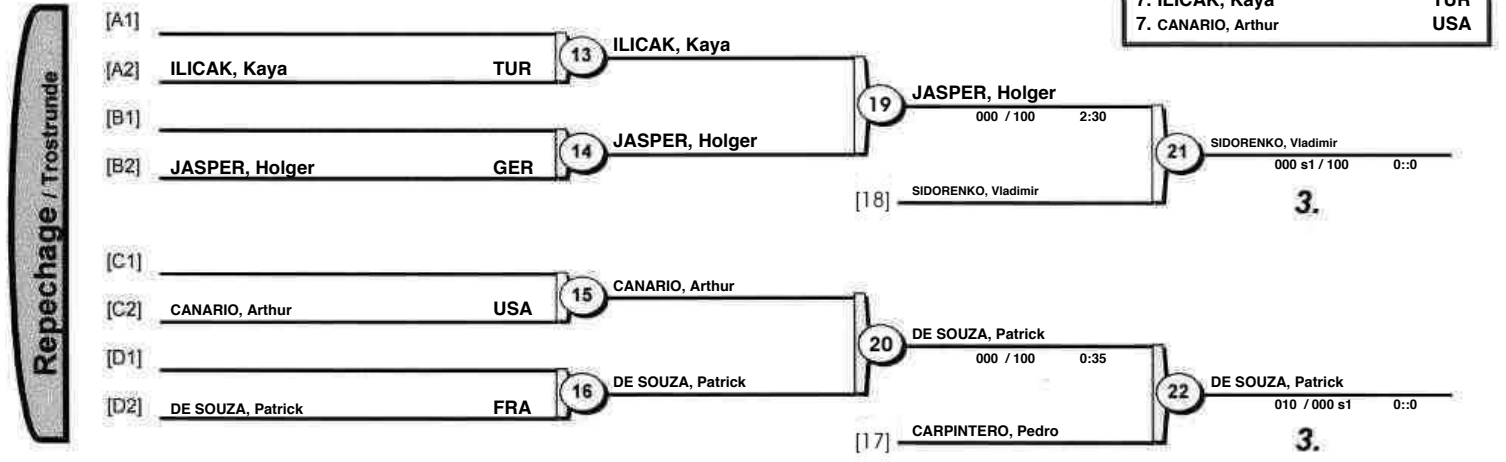



Veterans World Judo Championships 2016

(USA Fort Lauderdale, 18-21 November 2016)

M8 +100 kg

2 Judoka

BEST OF THREE

1	SCHERTEL, Lothar	GER	1	MAGERA, Viktor	RUS	000 / 100	2:19
2	MAGERA, Viktor	RUS					

1	SCHERTEL, Lothar	GER	2	MAGERA, Viktor	RUS	000 / 100	2:30
2	MAGERA, Viktor	RUS					

1	SCHERTEL, Lothar	GER	3	MAGERA, Viktor	RUS	000 / 000 s1	0::0
2	MAGERA, Viktor	RUS					

Final Results

1. MAGERA, Viktor RUS
2. SCHERTEL, Lothar GER



Veterans World Judo Championships 2016

(USA Fort Lauderdale, 18-21 November 2016)

M9 -66 kg

5 Judoka

			1	2	3	4	5		
1	HWANG, Steve	USA		1 (10)	1 (100)	0	0	2 (110)	
2	CROCKER, Roger	USA	0		1 (0.5)	0	0	1 (0.5)	
3	BARDAJI, Antonio	USA	0	0		0	0	(0)	
4	BATTAGLIA, Giovanni	ITA	1 (100)	1 (100)	1 (100)		1 (100)	4 (400)	
5	IDA, Mikio	JPN	1 (100)	1 (100)	1 (100)	0		3 (300)	

1 HWANG, Steve USA
 2 CROCKER, Roger USA
 ① HWANG, Steve USA
 011 s2 / 000 s1 0::0

3 BARDAJI, Antonio USA
 4 BATTAGLIA, Giovanni ITA
 ② BATTAGLIA, Giovanni ITA
 000 / 100 1:49

1 HWANG, Steve USA
 5 IDA, Mikio JPN
 ③ IDA, Mikio JPN
 000 / 100 1:53

2 CROCKER, Roger USA
 3 BARDAJI, Antonio USA
 ④ CROCKER, Roger USA
 000 / 000 s1 0::0

4 BATTAGLIA, Giovanni ITA
 5 IDA, Mikio JPN
 ⑤ BATTAGLIA, Giovanni ITA
 100 / 000 1:56

1 HWANG, Steve USA
 3 BARDAJI, Antonio USA
 ⑥ HWANG, Steve USA
 100 s1 / 000 0:36

2 CROCKER, Roger USA
 4 BATTAGLIA, Giovanni ITA
 ⑦ BATTAGLIA, Giovanni ITA
 000 s1 / 100 0:53

3 BARDAJI, Antonio USA
 5 IDA, Mikio JPN
 ⑧ IDA, Mikio JPN
 000 / 100 0:27

1 HWANG, Steve USA
 4 BATTAGLIA, Giovanni ITA
 ⑨ BATTAGLIA, Giovanni ITA
 000 / 100 1:55

2 CROCKER, Roger USA
 5 IDA, Mikio JPN
 ⑩ IDA, Mikio JPN
 000 / 100 0:35

Final Results

1. BATTAGLIA, Giovanni ITA
2. IDA, Mikio JPN
3. HWANG, Steve USA
- 3.



Veterans World Judo Championships 2016

(USA Fort Lauderdale, 18-21 November 2016)

M9 -73 kg

9 Judoka

POOL A

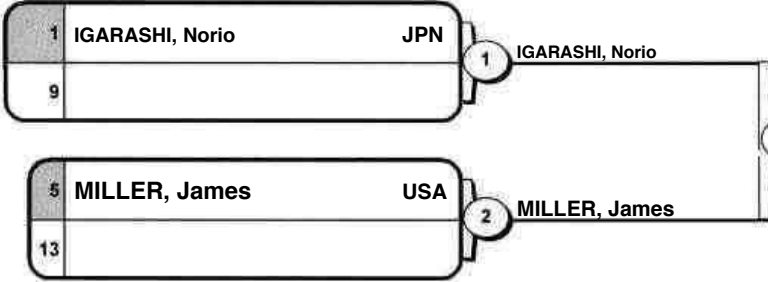

POOL B

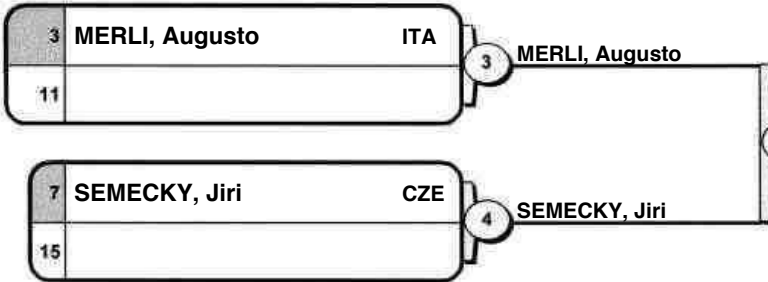

POOL C

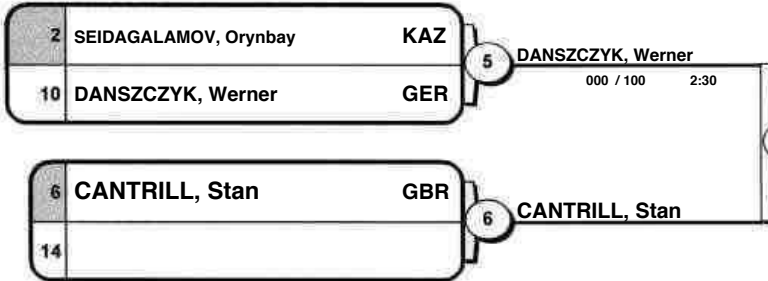

POOL D

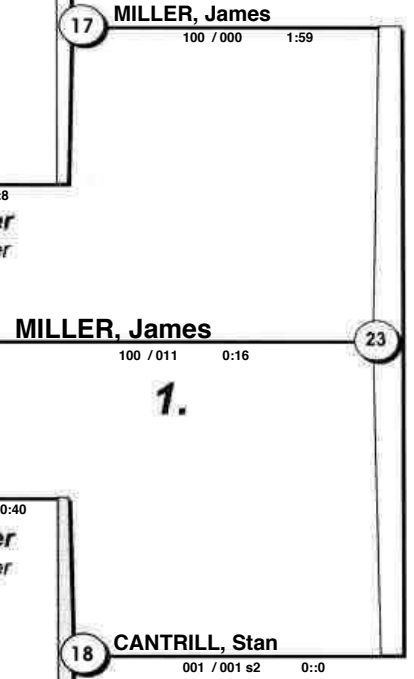
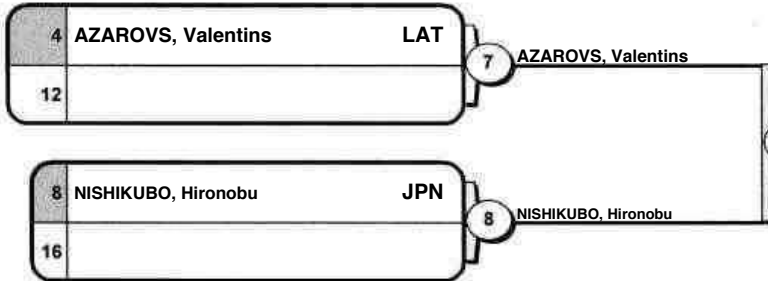

Results		
Résultat / Platzierungen		
1.	MILLER, James	USA
2.	CANTRILL, Stan	GBR
3.	IGARASHI, Norio	JPN
4.	AZAROV, Valentins	LAT
5.	NISHIKUBO, Hironobu	JPN
6.	SEMECKY, Jiri	CZE
7.	MERLI, Augusto	ITA
8.	DANCZYK, Werner	GER

Repechage / Trostrunde

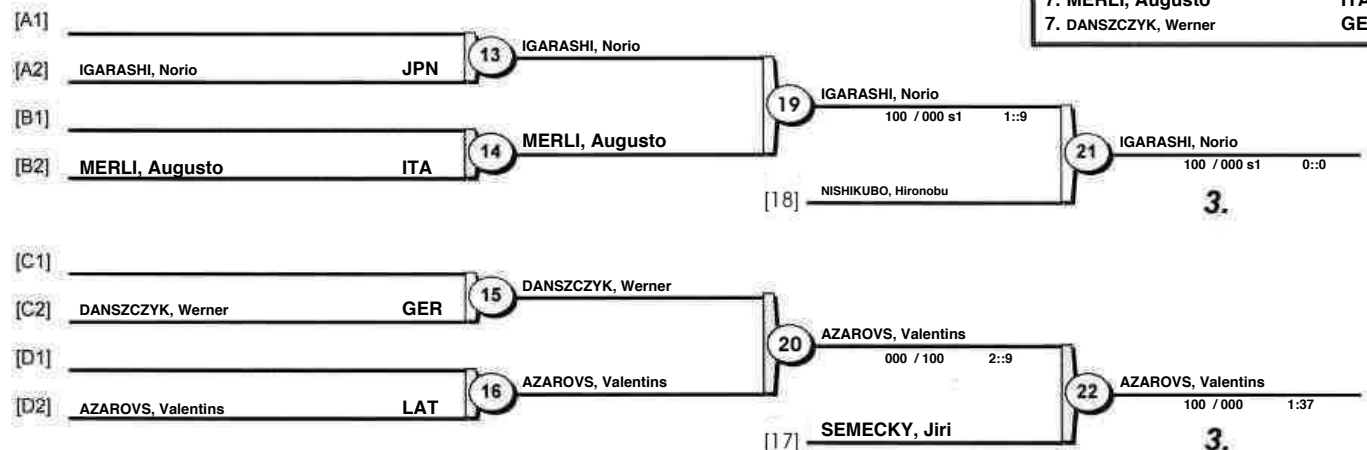



Veterans World Judo Championships 2016

(USA Fort Lauderdale, 18-21 November 2016)

M9 -81 kg

6 Judoka

POOL A

1 LERICHE, Alain FRA
9

1 LERICHE, Alain

5 OWEN, Steven USA
13

2 OWEN, Steven

9 LERICHE, Alain
100 / 000 0:46
Pool A - Winner
Vainqueur / Sieger

POOL B

3 ZARZA JUAN, Vicente ESP
11

3 ZARZA JUAN, Vicente

7
15

4

10 ZARZA JUAN, Vicente
Pool B - Winner
Vainqueur / Sieger

POOL C

2 WORTHEN, Clyde USA
10

5 WORTHEN, Clyde

6 PONCELA RUIZ DE AZUA, Gerardo ESP
14

6 PONCELA RUIZ DE AZUA, Gerardo

11 PONCELA RUIZ DE AZUA, Gerardo
000 sH / 101 s1 0:8
Pool C - Winner
Vainqueur / Sieger

POOL D

4 WEST, James USA
12

7 WEST, James

8
16

8

12 WEST, James
Pool D - Winner
Vainqueur / Sieger

17 LERICHE, Alain
101 / 010 s1 0:8

23 LERICHE, Alain
010 / 000 s1 0:0

18 WEST, James
000 / 101 s1 0:0

Results		
Résultat / Platzierungen		
1.	LERICHE, Alain	FRA
2.	WEST, James	USA
3.	PONCELA RUIZ DE AZUA, Gerardo	ESP
3.	ZARZA JUAN, Vicente	ESP
5.	OWEN, Steven	USA
7.	WORTHEN, Clyde	USA
7.		

Repechage / Trostrunde

[A1] _____

[A2] OWEN, Steven USA 13 OWEN, Steven

[B1] _____

[B2] _____ 14

19 OWEN, Steven

[18] PONCELA RUIZ DE AZUA, Gerardo 21 PONCELA RUIZ DE AZUA, Gerardo
000 s2 / 000 0:0

3.

[C1] _____

[C2] WORTHEN, Clyde USA 15 WORTHEN, Clyde

[D1] _____

[D2] _____ 16

20 WORTHEN, Clyde

[17] ZARZA JUAN, Vicente 22 ZARZA JUAN, Vicente
000 s4 / 100 2:7

3.



Veterans World Judo Championships 2016

(USA Fort Lauderdale, 18-21 November 2016)

M9 -90 kg

7 Judoka

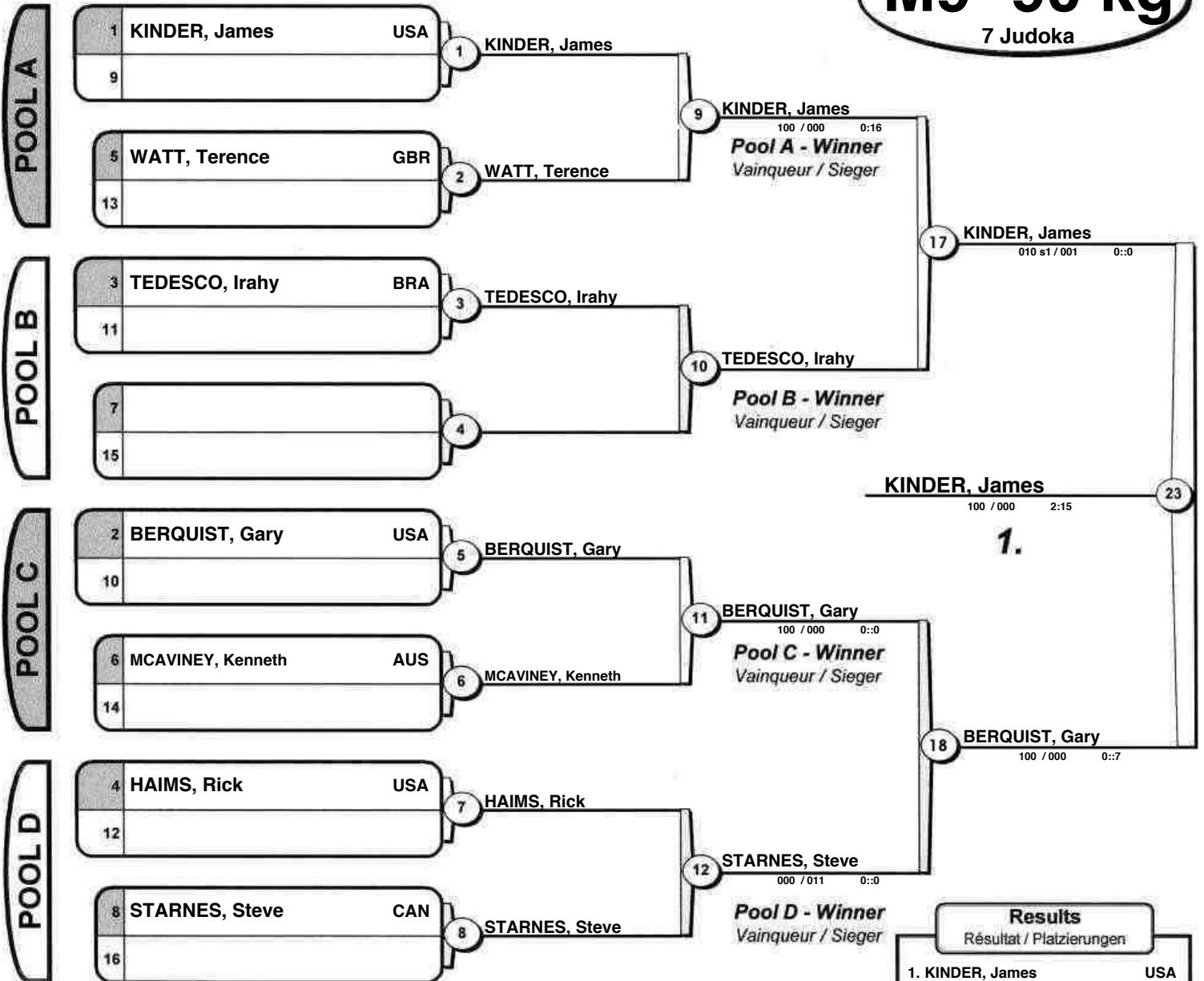

Results		
Résultat / Platzierungen		
1.	KINDER, James	USA
2.	BERQUIST, Gary	USA
3.	WATT, Terence	GBR
3.	TEDESCO, Irahya	BRA
5.	STARNES, Steve	CAN
5.	MCAVINEY, Kenneth	AUS
7.	HAIMS, Rick	USA

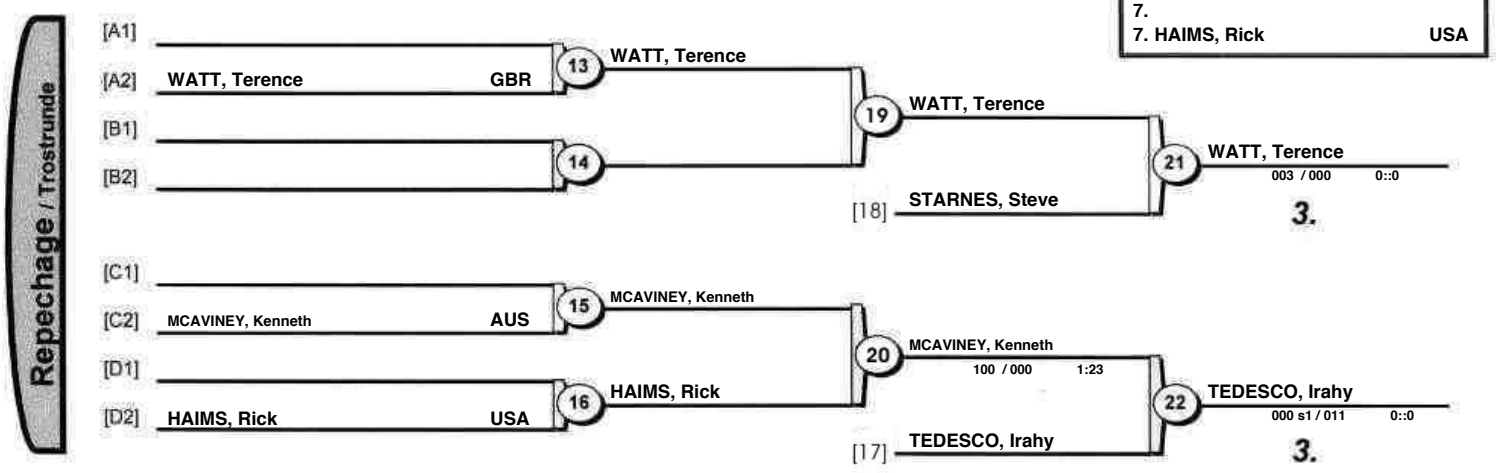



Veterans World Judo Championships 2016

(USA Fort Lauderdale, 18-21 November 2016)

M10 -66 kg

2 Judoka

BEST OF THREE

1	ONIYANAGI, Kazutaka	JPN	1	ONIYANAGI, Kazutaka	JPN
2	NAKAJIMA, Tadashi	JPN		100 s1 / 000 s1	0:35

1	ONIYANAGI, Kazutaka	JPN	2	ONIYANAGI, Kazutaka	JPN
2	NAKAJIMA, Tadashi	JPN		110 / 000	1:46

1	ONIYANAGI, Kazutaka	JPN	3	ONIYANAGI, Kazutaka	JPN
2	NAKAJIMA, Tadashi	JPN		000 s1 / 000	0::0

Final Results

1. ONIYANAGI, Kazutaka JPN
2. NAKAJIMA, Tadashi JPN



Veterans World Judo Championships 2016

(USA Fort Lauderdale, 18-21 November 2016)

M10 -73 kg

3 Judoka

			1	2	3		
1	ROSARNO PROTO, Roberto	ARG		-	-	0 (0)	
2	NAITO, Jun	JPN	+		+	2 (11)	
3	SONG, Tiger	USA	+	-		1 (1)	

1	ROSARNO PROTO, Roberto	ARG	1	NAITO, Jun	JPN
2	NAITO, Jun	JPN		000 s1 / 000	0::0

1	ROSARNO PROTO, Roberto	ARG	2	SONG, Tiger	USA
3	SONG, Tiger	USA		000 s2 / 000	0::0

2	NAITO, Jun	JPN	3	NAITO, Jun	JPN
3	SONG, Tiger	USA		100 / 000	2:13

Final Results

1. NAITO, Jun JPN
2. SONG, Tiger USA
3. ROSARNO PROTO, Roberto ARG



Veterans World Judo Championships 2016

(USA Fort Lauderdale, 18-21 November 2016)

M10 -100 kg

3 Judoka

			1	2	3		
1	BYRD, Robert	USA		-	-	0 (0)	
2	ISHII, Chiaki	BRA	+		+	2 (11)	
3	RASOVIC, Vuk	SRB	+	-		1 (7)	

1	BYRD, Robert	USA	1	ISHII, Chiaki	BRA
2	ISHII, Chiaki	BRA		000 / 100	2::7

1	BYRD, Robert	USA	2	RASOVIC, Vuk	SRB
3	RASOVIC, Vuk	SRB		000 s1 / 010	0::0

2	ISHII, Chiaki	BRA	3	ISHII, Chiaki	BRA
3	RASOVIC, Vuk	SRB		000 / 000 s2	0::0

Final Results

1. ISHII, Chiaki BRA
2. RASOVIC, Vuk SRB
3. BYRD, Robert USA



Veterans World Judo Championships 2016

(USA Fort Lauderdale, 18-21 November 2016)

M10 +100 kg

5 Judoka

			1	2	3	4	5		
1	REX, Winfried	GER		1 (100)	1 (100)	1 (100)	0	3 (300)	
2	SOEFFING, Hartmut	GER	0		0	0	0	(0)	
3	MALEAR, Mihail	MDA	0	1 (100)		1 (100)	1 (100)	3 (300)	
4	MAKHIN, Anatoly	RUS	0	1 (100)	0		0	1 (100)	
5	VAGNER, Milan	CZE	1 (100)	1 (100)	0	1 (0.5)		3 (200.5)	

1	REX, Winfried	GER	1	REX, Winfried	GER
2	SOEFFING, Hartmut	GER		100 / 000	1:18

3	MALEAR, Mihail	MDA	2	MALEAR, Mihail	MDA
4	MAKHIN, Anatoly	RUS		100 / 000	1:56

1	REX, Winfried	GER	3	VAGNER, Milan	CZE
5	VAGNER, Milan	CZE		000 / 100 s1	2::6

2	SOEFFING, Hartmut	GER	4	MALEAR, Mihail	MDA
3	MALEAR, Mihail	MDA		000 / 100	2:17

4	MAKHIN, Anatoly	RUS	5	VAGNER, Milan	CZE
5	VAGNER, Milan	CZE		000 s2 / 000	0::0

1	REX, Winfried	GER	6	REX, Winfried	GER
3	MALEAR, Mihail	MDA		100 / 000	2:30

2	SOEFFING, Hartmut	GER	7	MAKHIN, Anatoly	RUS
4	MAKHIN, Anatoly	RUS		000 / 100	2:30

3	MALEAR, Mihail	MDA	8	MALEAR, Mihail	MDA
5	VAGNER, Milan	CZE		110 s1 / 000	1:20

1	REX, Winfried	GER	9	REX, Winfried	GER
4	MAKHIN, Anatoly	RUS		100 / 000	2:30

2	SOEFFING, Hartmut	GER	10	VAGNER, Milan	CZE
5	VAGNER, Milan	CZE		000 / 100	2:29

Final Results

1. REX, Winfried GER
2. MALEAR, Mihail MDA
3. VAGNER, Milan CZE
- 3.



Veterans World Judo Championships 2016

(USA Fort Lauderdale, 18-21 November 2016)

M11 -66 kg

4 Judoka

			1	2	3	4			
1	SUGIHARA, Takashi	JPN		1 (100)			1 (100)		
2	OKADA, Kurajiro	JPN	0				(0)		
3	KLOUVATOS, Nikolaos	GRE				1 (100)	1 (100)		
4	JOBB, Andor	USA			0		(0)		

1	SUGIHARA, Takashi	JPN	①	SUGIHARA, Takashi	JPN
2	OKADA, Kurajiro	JPN		100 / 000	0::0

3	KLOUVATOS, Nikolaos	GRE	②	KLOUVATOS, Nikolaos	GRE
4	JOBB, Andor	USA		100 / 000	0::0

1	SUGIHARA, Takashi	JPN	③	_____
3	KLOUVATOS, Nikolaos	GRE		_____

2	OKADA, Kurajiro	JPN	④	_____
4	JOBB, Andor	USA		_____

1	SUGIHARA, Takashi	JPN	⑤	_____
4	JOBB, Andor	USA		_____

2	OKADA, Kurajiro	JPN	⑥	_____
3	KLOUVATOS, Nikolaos	GRE		_____

Final Results



- 1.
- 2.
- 3.
- 3.



Veterans World Judo Championships 2016

(USA Fort Lauderdale, 18-21 November 2016)

M11 -90 kg

3 Judoka

			1	2	3		
1	BURGESS, Alexander	USA		+	-	1 (10)	
2	VERMEIREN, Herman	CAN	-		+	1 (10)	
3	MATUSZEK, Georg	GER	+	-		1 (10)	

1	BURGESS, Alexander	USA	1	BURGESS, Alexander	USA
2	VERMEIREN, Herman	CAN		100 / 000	2:30

1	BURGESS, Alexander	USA	2	MATUSZEK, Georg	GER
3	MATUSZEK, Georg	GER		000 / 100	2:30

2	VERMEIREN, Herman	CAN	3	VERMEIREN, Herman	CAN
3	MATUSZEK, Georg	GER		100 / 000	2:30

Final Results

1. VERMEIREN, Herman CAN
2. MATUSZEK, Georg GER
3. BURGESS, Alexander USA



Veterans World Judo Championships 2016

(USA Fort Lauderdale, 18-21 November 2016)

F1 -52 kg

4 Judoka

			1	2	3	4			
1	GUENSCH, Stephanie	GER		0	0	1 (100)	1 (100)		
2	PALMA, Amalia	ITA	1 (100)		0	1 (100)	2 (200)		
3	ILLES, Aniko	HUN	1 (100)	1 (100)		1 (100)	3 (300)		
4	WEDEMO, Claudia	SWE	0	0	0		(0)		

1	GUENSCH, Stephanie	GER	1	PALMA, Amalia	ITA	000 / 100	1::9
2	PALMA, Amalia	ITA					
3	ILLES, Aniko	HUN	2	ILLES, Aniko	HUN	100 / 000	3::0
4	WEDEMO, Claudia	SWE					
1	GUENSCH, Stephanie	GER	3	ILLES, Aniko	HUN	000 / 100	2:30
3	ILLES, Aniko	HUN					
2	PALMA, Amalia	ITA	4	PALMA, Amalia	ITA	100 / 000	2:26
4	WEDEMO, Claudia	SWE					
1	GUENSCH, Stephanie	GER	5	GUENSCH, Stephanie	GER	100 / 000 s4	0:30
4	WEDEMO, Claudia	SWE					
2	PALMA, Amalia	ITA	6	ILLES, Aniko	HUN	000 / 100	1::4
3	ILLES, Aniko	HUN					

Final Results

1. ILLES, Aniko HUN
2. PALMA, Amalia ITA
3. GUENSCH, Stephanie GER
- 3.



Veterans World Judo Championships 2016

(USA Fort Lauderdale, 18-21 November 2016)

F1 -57 kg

4 Judoka

			1	2	3	4			
1	BEN SALAH, Jamila	FRA		0	0	0	(0)		
2	MARTIN, Vanessa	FRA	1 (100)		0	1 (100)	2 (200)		
3	ONODY, Beata	HUN	1 (100)	1 (1)		1 (0.5)	3 (101.5)		
4	MANGIOLA, Marina	SUI	1 (100)	0	0		1 (100)		

1	BEN SALAH, Jamila	FRA	①	MARTIN, Vanessa	FRA
2	MARTIN, Vanessa	FRA		000 / 100	1:33

3	ONODY, Beata	HUN	②	ONODY, Beata	HUN
4	MANGIOLA, Marina	SUI		000 / 000 s1	0::0

1	BEN SALAH, Jamila	FRA	③	ONODY, Beata	HUN
3	ONODY, Beata	HUN		000 / 100	2:49

2	MARTIN, Vanessa	FRA	④	MARTIN, Vanessa	FRA
4	MANGIOLA, Marina	SUI		100 / 000	2:23

1	BEN SALAH, Jamila	FRA	⑤	MANGIOLA, Marina	SUI
4	MANGIOLA, Marina	SUI		000 / 101	2::6

2	MARTIN, Vanessa	FRA	⑥	ONODY, Beata	HUN
3	ONODY, Beata	HUN		000 / 001 s1	0::0

Final Results

1. ONODY, Beata HUN
2. MARTIN, Vanessa FRA
3. MANGIOLA, Marina SUI
- 3.



Veterans World Judo Championships 2016

(USA Fort Lauderdale, 18-21 November 2016)

F1 -63 kg

3 Judoka

			1	2	3		
1	TURBAT, Enkhtsetseg	MGL		+	+	2 (11)	
2	GUILBAUD, Audren	FRA	-		-	0 (0)	
3	BRIDGEMAN, Fraser	CAN	-	+		1 (10)	

1	TURBAT, Enkhtsetseg	MGL	1	TURBAT, Enkhtsetseg	MGL
2	GUILBAUD, Audren	FRA		111 s2 / 000	0::1

1	TURBAT, Enkhtsetseg	MGL	2	TURBAT, Enkhtsetseg	MGL
3	BRIDGEMAN, Fraser	CAN		000 / 000 s1	0::0

2	GUILBAUD, Audren	FRA	3	BRIDGEMAN, Fraser	CAN
3	BRIDGEMAN, Fraser	CAN		000 / 100	2:15

Final Results

- TURBAT, Enkhtsetseg MGL
- BRIDGEMAN, Fraser CAN
- GUILBAUD, Audren FRA



Veterans World Judo Championships 2016

(USA Fort Lauderdale, 18-21 November 2016)

F1 -70 kg

8 Judoka

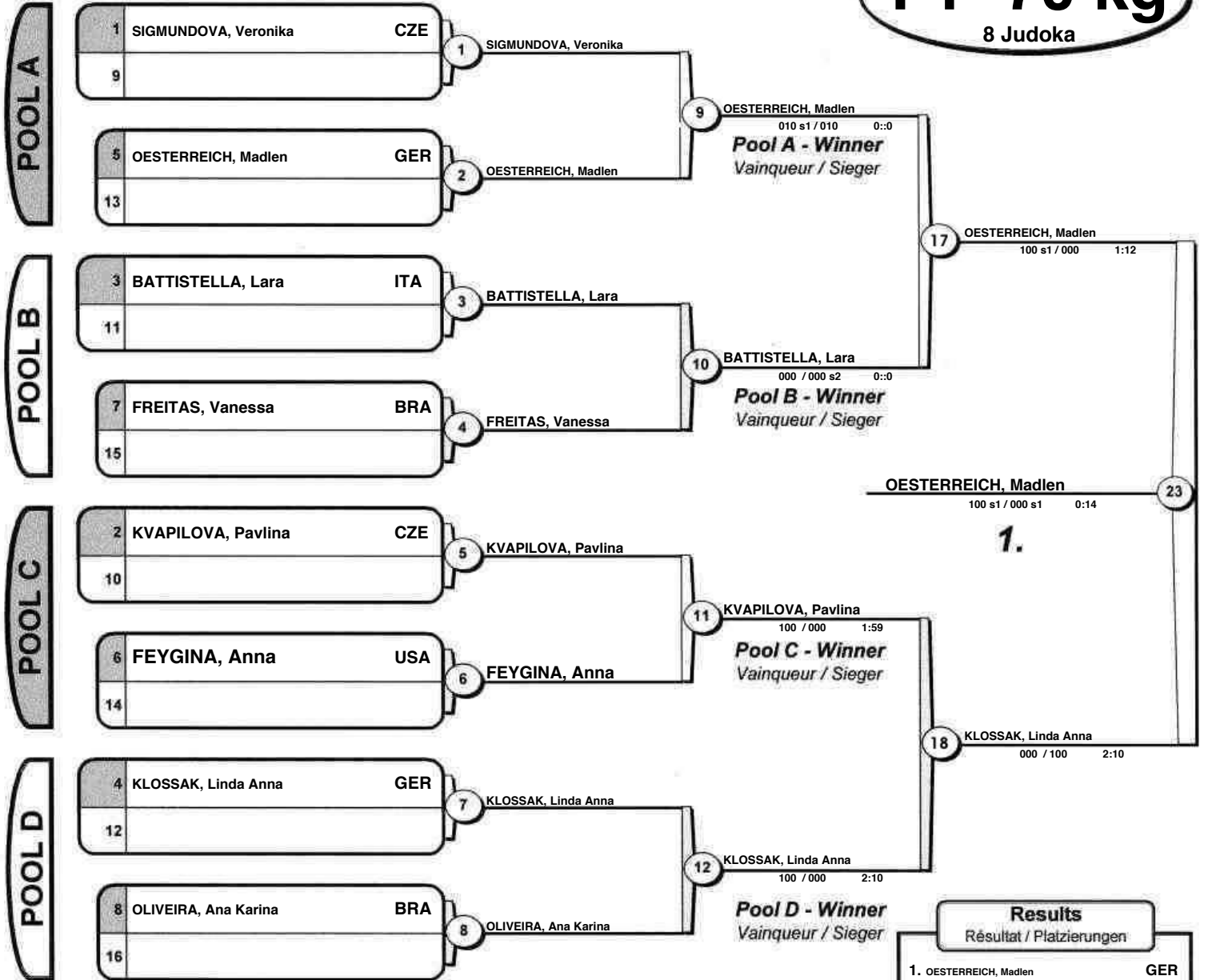

Results	
Résultat / Platzierungen	
1.	OESTERREICH, Madlen GER
2.	KLOSSAK, Linda Anna GER
3.	SIGMUNDOVA, Veronika CZE
3.	BATTISTELLA, Lara ITA
5.	KVAPILOVA, Pavlina CZE
5.	FEYGINA, Anna USA
7.	FREITAS, Vanessa BRA
7.	OLIVEIRA, Ana Karina BRA

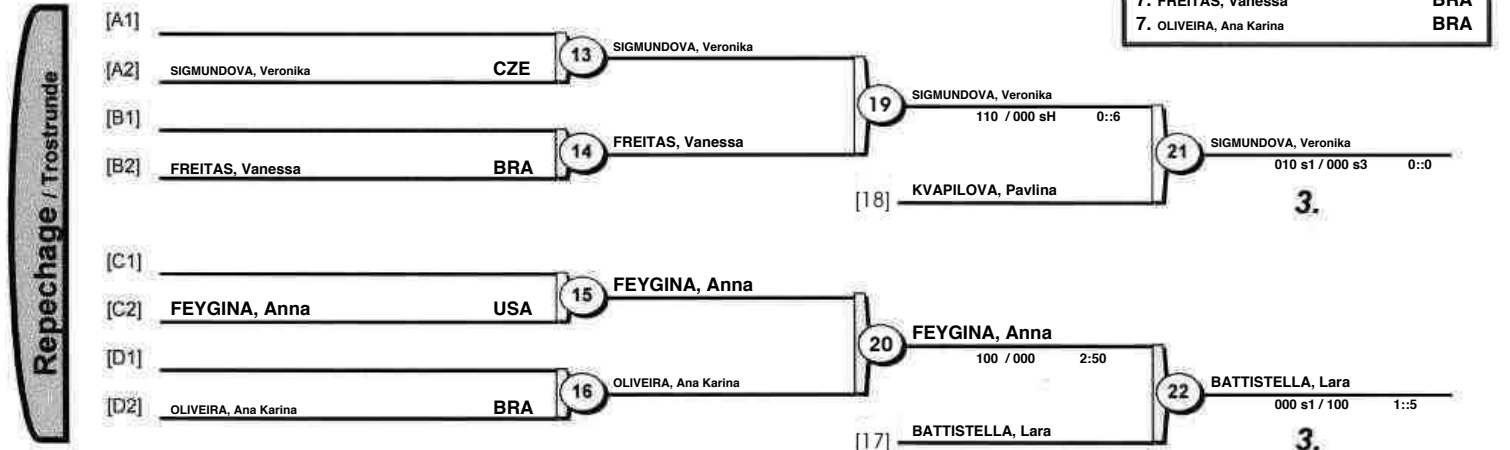



Veterans World Judo Championships 2016

(USA Fort Lauderdale, 18-21 November 2016)

F1 -78 kg

2 Judoka

BEST OF THREE

1	WILD, Viktoria	GER	1	JYOTI, Jyoti	IND	000 / 001 s1	0::0
2	JYOTI, Jyoti	IND					

1	WILD, Viktoria	GER	2	WILD, Viktoria	GER	000 s2 / 000 s3	0:47
2	JYOTI, Jyoti	IND					

1	WILD, Viktoria	GER	3	WILD, Viktoria	GER	100 s1 / 000 s2	0:18
2	JYOTI, Jyoti	IND					

Final Results

1. WILD, Viktoria GER
2. JYOTI, Jyoti IND



Veterans World Judo Championships 2016

(USA Fort Lauderdale, 18-21 November 2016)

F2 -52 kg

4 Judoka

			1	2	3	4			
1	MAGNES, Pascaline	FRA		0	0	0		(0)	
2	STOILJKOVIC, Vesna	SRB	1 (100)		0	0		1 (100)	
3	TADINI, Manuela	ITA	1 (100)	1 (0.5)		0		2 (100.5)	
4	NORDIN, Malin	SWE	1 (100)	1 (100)	1 (100)			3 (300)	

1	MAGNES, Pascaline	FRA	1	STOILJKOVIC, Vesna	SRB
2	STOILJKOVIC, Vesna	SRB		000 s1 / 100	2:26

3	TADINI, Manuela	ITA	2	NORDIN, Malin	SWE
4	NORDIN, Malin	SWE		000 s1 / 101	0::0

1	MAGNES, Pascaline	FRA	3	TADINI, Manuela	ITA
3	TADINI, Manuela	ITA		000 / 101	2:19

2	STOILJKOVIC, Vesna	SRB	4	NORDIN, Malin	SWE
4	NORDIN, Malin	SWE		000 s1 / 100	0:40

1	MAGNES, Pascaline	FRA	5	NORDIN, Malin	SWE
4	NORDIN, Malin	SWE		000 s1 / 100	1:41

2	STOILJKOVIC, Vesna	SRB	6	TADINI, Manuela	ITA
3	TADINI, Manuela	ITA		000 s1 / 000	0::0

Final Results

- NORDIN, Malin SWE
- TADINI, Manuela ITA
- STOILJKOVIC, Vesna SRB
-



Veterans World Judo Championships 2016

(USA Fort Lauderdale, 18-21 November 2016)

F2 -57 kg

7 Judoka

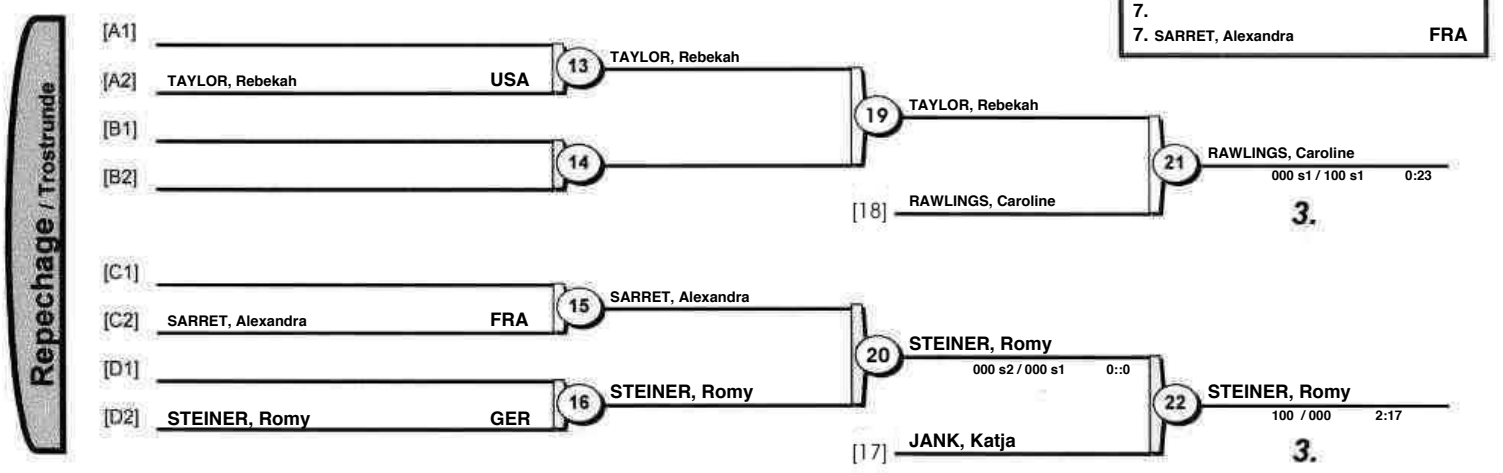
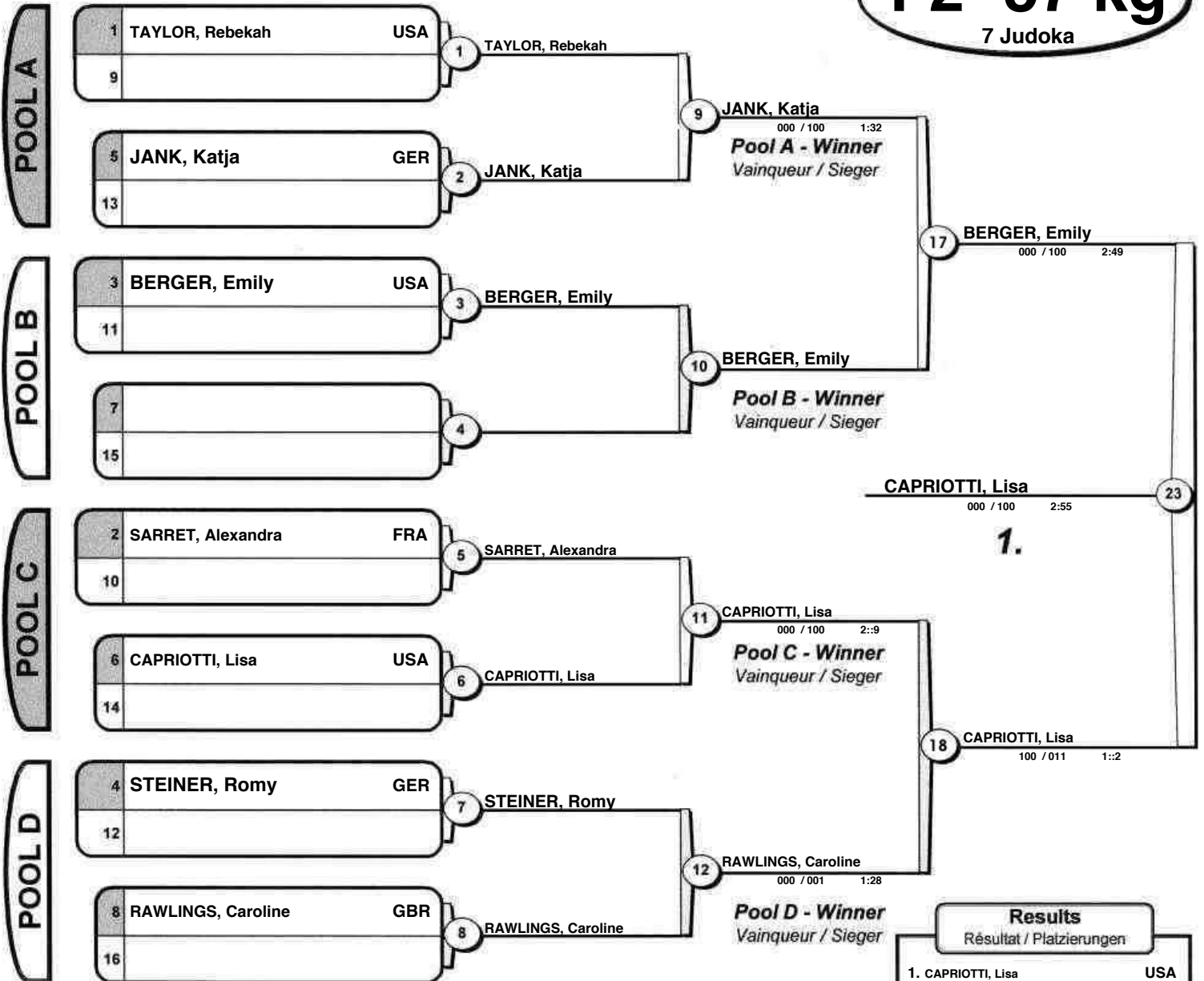



Veterans World Judo Championships 2016

(USA Fort Lauderdale, 18-21 November 2016)

F2 -63 kg

8 Judoka

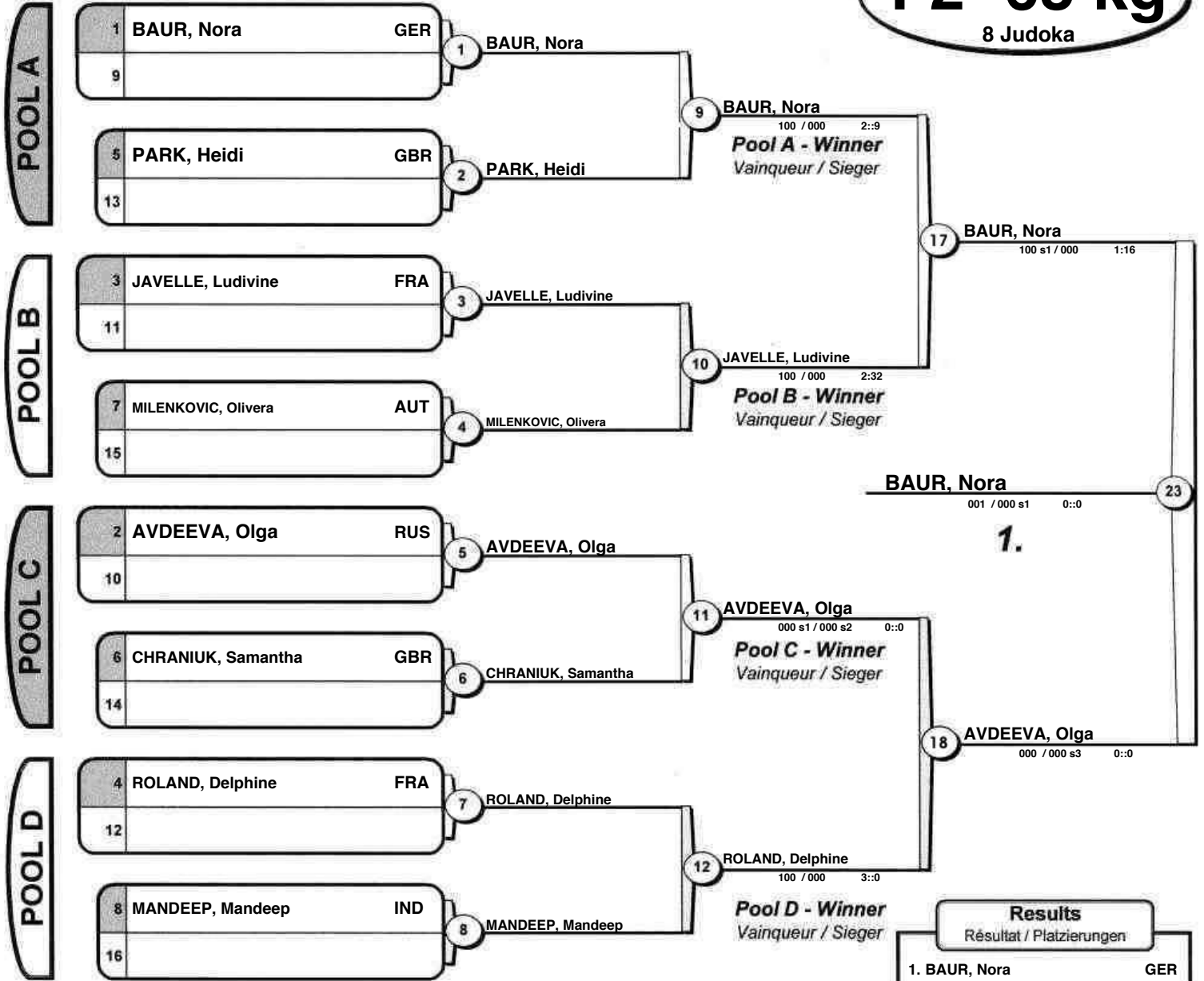

Results		
Résultat / Platzierungen		
1.	BAUR, Nora	GER
2.	AVDEEVA, Olga	RUS
3.	ROLAND, Delphine	FRA
4.	JAVELLE, Ludivine	FRA
5.	MILENKOVIC, Olivera	AUT
6.	CHRANIUK, Samantha	GBR
7.	PARK, Heidi	GBR
8.	MANDEEP, Mandeep	IND

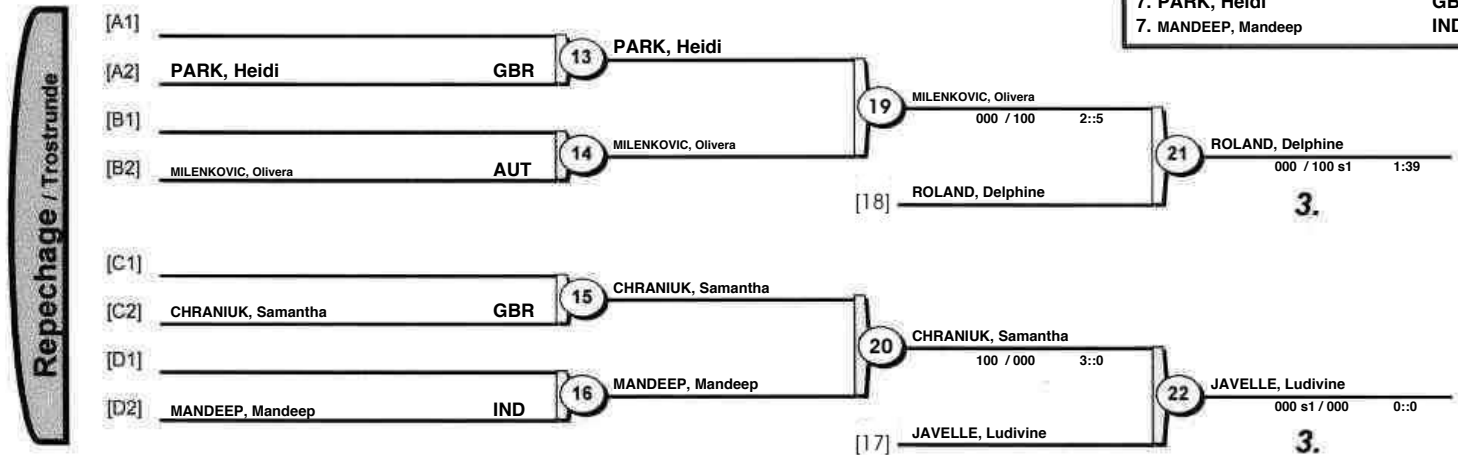



Veterans World Judo Championships 2016

(USA Fort Lauderdale, 18-21 November 2016)

F2 -70 kg

4 Judoka

			1	2	3	4			
1	TALUSAN, Grace	USA		0	0	1 (100)	1 (100)		
2	SASAKI, Rieko	JPN	1 (100)		1 (100)	1 (100)	3 (300)		
3	GOROSTIAGA, Sandra	ARG	1 (100)	0		1 (100)	2 (200)		
4	ANJANA, Mann	IND	0	0	0		(0)		

1	TALUSAN, Grace	USA	①	SASAKI, Rieko	JPN
2	SASAKI, Rieko	JPN		000 / 100	2:47

3	GOROSTIAGA, Sandra	ARG	②	GOROSTIAGA, Sandra	ARG
4	ANJANA, Mann	IND		100 / 000	3::0

1	TALUSAN, Grace	USA	③	GOROSTIAGA, Sandra	ARG
3	GOROSTIAGA, Sandra	ARG		000 / 100	1:27

2	SASAKI, Rieko	JPN	④	SASAKI, Rieko	JPN
4	ANJANA, Mann	IND		100 / 000	2:59

1	TALUSAN, Grace	USA	⑤	TALUSAN, Grace	USA
4	ANJANA, Mann	IND		100 / 000	3::0

2	SASAKI, Rieko	JPN	⑥	SASAKI, Rieko	JPN
3	GOROSTIAGA, Sandra	ARG		100 / 000 s1	1:19

Final Results

1. SASAKI, Rieko JPN
2. GOROSTIAGA, Sandra ARG
3. TALUSAN, Grace USA
- 3.



Veterans World Judo Championships 2016

(USA Fort Lauderdale, 18-21 November 2016)

F2 -78 kg

6 Judoka

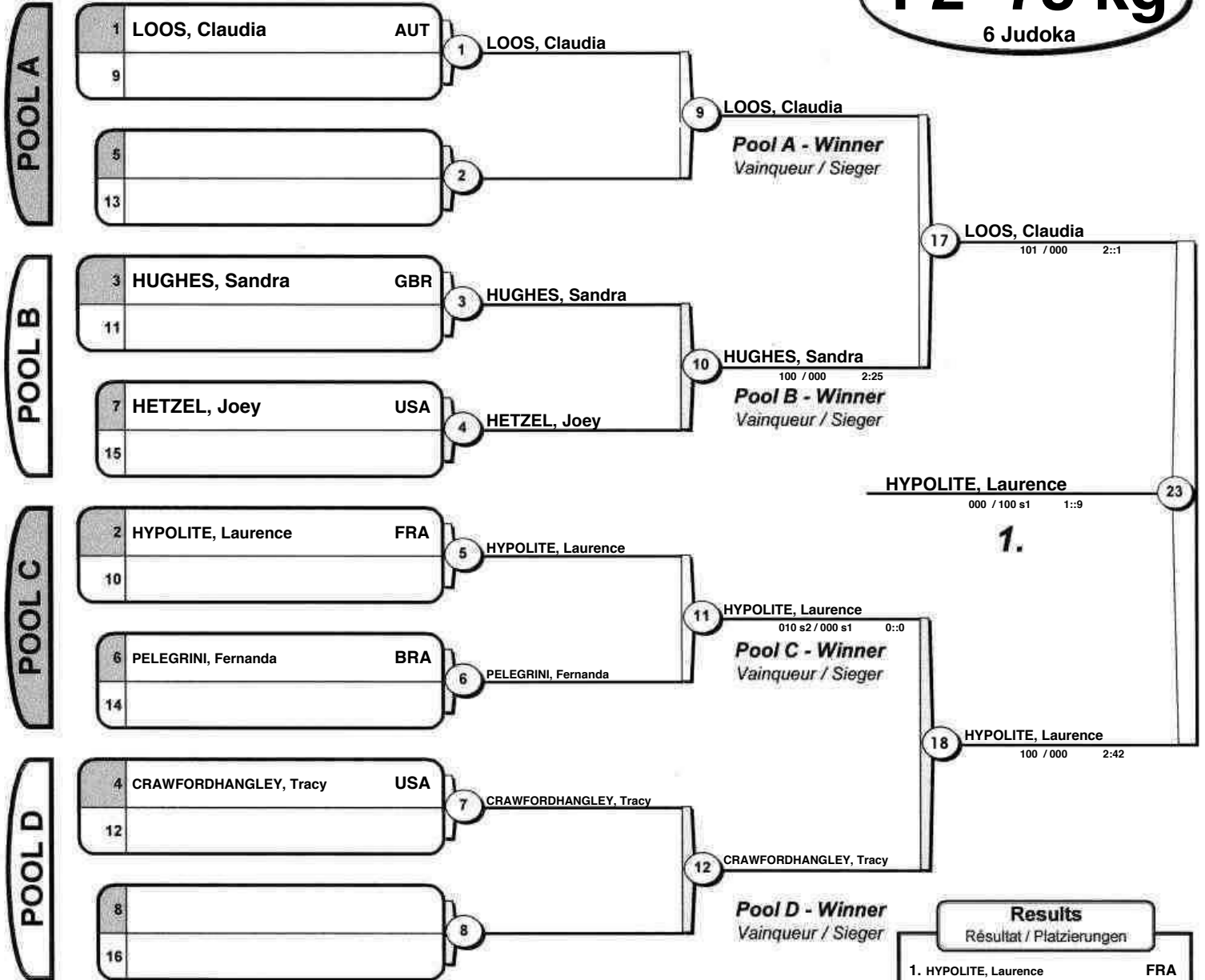

Results	
Résultat / Platzierungen	
1.	HYPOLITE, Laurence FRA
2.	LOOS, Claudia AUT
3.	CRAWFORDHANGLEY, Tracy USA
3.	PELEGRINI, Fernanda BRA
5.	HETZEL, Joey USA
5.	HUGHES, Sandra GBR
7.	
7.	

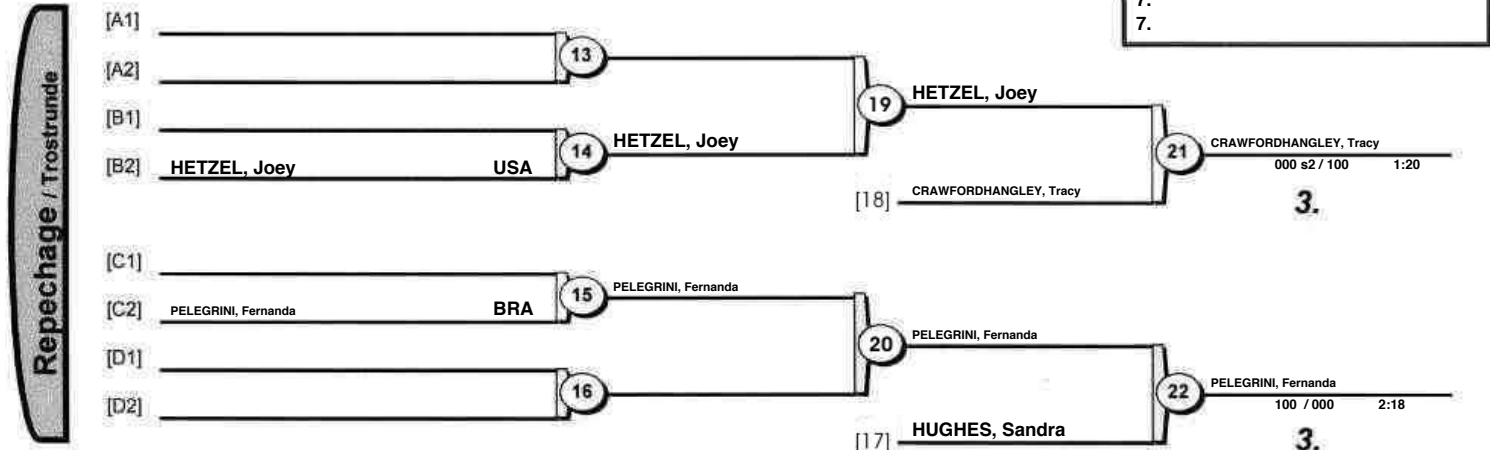



Veterans World Judo Championships 2016

(USA Fort Lauderdale, 18-21 November 2016)

F2 +78 kg

4 Judoka

			1	2	3	4			
1	CRAMPTON REID, Ronda	GBR		0	0	1 (100)	1 (100)		
2	WEISS, Carmen	GER	1 (100)		0	1 (100)	2 (200)		
3	MACHY, Melanie	FRA	1 (100)	1 (100)		1 (100)	3 (300)		
4	BERENDS, Ann	USA	0	0	0		(0)		

1	CRAMPTON REID, Ronda	GBR	①	WEISS, Carmen	GER
2	WEISS, Carmen	GER		000 s1 / 101	1::6

3	MACHY, Melanie	FRA	②	MACHY, Melanie	FRA
4	BERENDS, Ann	USA		101 / 000	2:35

1	CRAMPTON REID, Ronda	GBR	③	MACHY, Melanie	FRA
3	MACHY, Melanie	FRA		000 s1 / 100	0:19

2	WEISS, Carmen	GER	④	WEISS, Carmen	GER
4	BERENDS, Ann	USA		100 / 000	2:13

1	CRAMPTON REID, Ronda	GBR	⑤	CRAMPTON REID, Ronda	GBR
4	BERENDS, Ann	USA		110 s1 / 000	0:46

2	WEISS, Carmen	GER	⑥	MACHY, Melanie	FRA
3	MACHY, Melanie	FRA		000 sH / 100	0:59

Final Results

1. MACHY, Melanie FRA
2. WEISS, Carmen GER
3. CRAMPTON REID, Ronda GBR
- 3.



Veterans World Judo Championships 2016

(USA Fort Lauderdale, 18-21 November 2016)

F3 -48 kg

2 Judoka

BEST OF THREE

1	CISTA, Vendula	CZE	1	DIAZ, Angelique	FRA	000 / 100	1:35
2	DIAZ, Angelique	FRA					

1	CISTA, Vendula	CZE	2	DIAZ, Angelique	FRA	000 / 110	2:14
2	DIAZ, Angelique	FRA					

1	CISTA, Vendula	CZE	3	DIAZ, Angelique	FRA	000 / 000 s1	0::0
2	DIAZ, Angelique	FRA					

Final Results

1. DIAZ, Angelique FRA
2. CISTA, Vendula CZE



Veterans World Judo Championships 2016

(USA Fort Lauderdale, 18-21 November 2016)

F3 -52 kg

2 Judoka

BEST OF THREE

1	HAUGEN, Nina	NOR	1	HAUGEN, Nina	NOR	100 / 000	2:12
2	FIEDEL, Ines	GER					

1	HAUGEN, Nina	NOR	2	HAUGEN, Nina	NOR	100 s1 / 001	1:41
2	FIEDEL, Ines	GER					

1	HAUGEN, Nina	NOR	3	HAUGEN, Nina	NOR	000 s1 / 000	0::0
2	FIEDEL, Ines	GER					

Final Results

1. HAUGEN, Nina NOR
2. FIEDEL, Ines GER



Veterans World Judo Championships 2016

(USA Fort Lauderdale, 18-21 November 2016)

F3 -57 kg

6 Judoka

POOL A

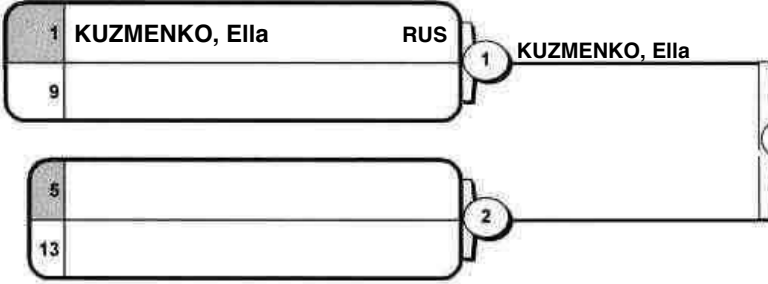

Pool A - Winner
Vainqueur / Sieger

POOL B

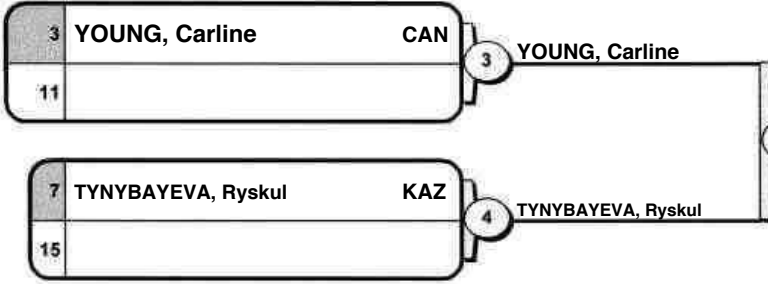

Pool B - Winner
Vainqueur / Sieger

POOL C

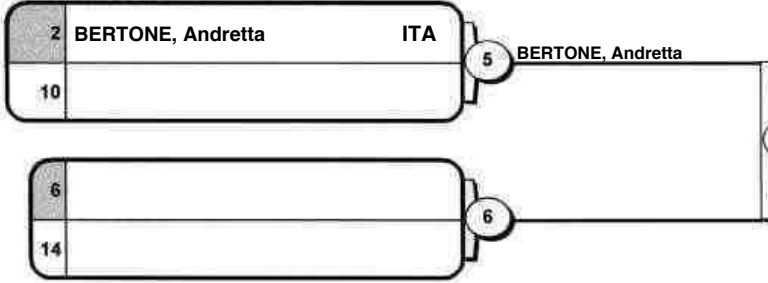

Pool C - Winner
Vainqueur / Sieger

POOL D

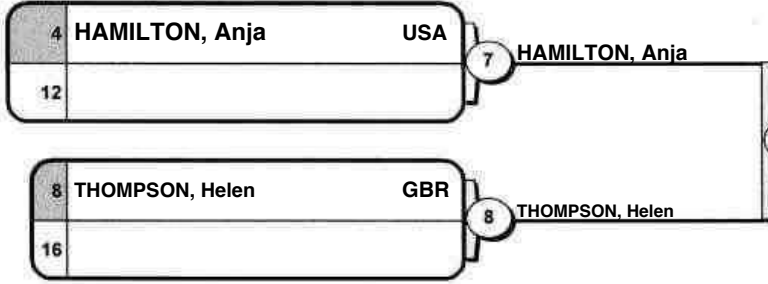

Pool D - Winner
Vainqueur / Sieger

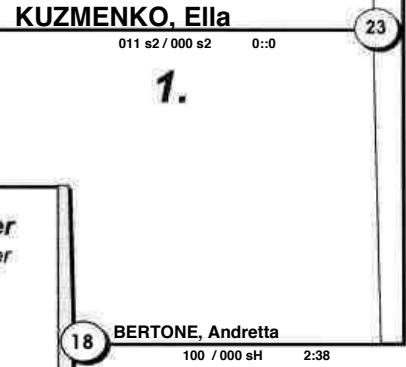

KUZMENKO, Ella

1.

Results		
Résultat / Platzierungen		
1.	KUZMENKO, Ella	RUS
2.	BERTONE, Andretta	ITA
3.	TYNBAYEVA, Ryskul	KAZ
3.	YOUNG, Carline	CAN
5.	HAMILTON, Anja	USA
5.	THOMPSON, Helen	GBR
7.		
7.		

Repechage / Trostrunde

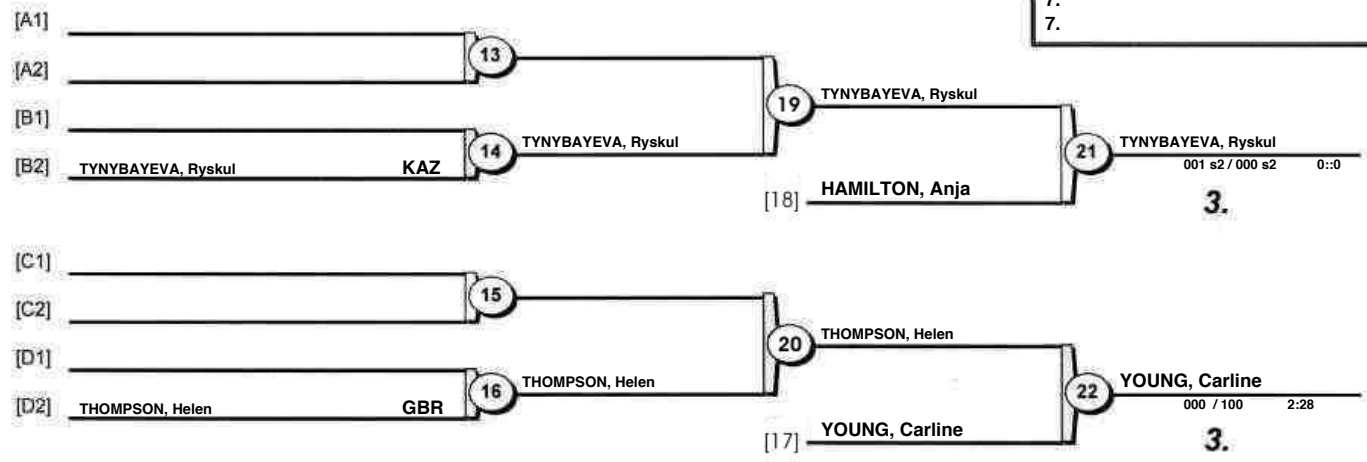

3.

3.



Veterans World Judo Championships 2016

(USA Fort Lauderdale, 18-21 November 2016)

F3 -63 kg

4 Judoka

			1	2	3	4			
1	LEVIN, Janna	USA		1 (100)	0	0	1 (100)		
2	MIJIDDORJ, Sarangua	MGL	0		0	0	(0)		
3	PAILLARD, Karine	FRA	1 (100)	1 (100)		1 (100)	3 (300)		
4	VESZI, Klara	HUN	1 (100)	1 (100)	0		2 (200)		

1	LEVIN, Janna	USA	1	LEVIN, Janna	USA
2	MIJIDDORJ, Sarangua	MGL		100 / 000	2:37

3	PAILLARD, Karine	FRA	2	PAILLARD, Karine	FRA
4	VESZI, Klara	HUN		100 / 000	0:16

1	LEVIN, Janna	USA	3	PAILLARD, Karine	FRA
3	PAILLARD, Karine	FRA		000 s1 / 100	2::2

2	MIJIDDORJ, Sarangua	MGL	4	VESZI, Klara	HUN
4	VESZI, Klara	HUN		000 s1 / 100 s1	1:53

1	LEVIN, Janna	USA	5	VESZI, Klara	HUN
4	VESZI, Klara	HUN		000 / 101	0:43

2	MIJIDDORJ, Sarangua	MGL	6	PAILLARD, Karine	FRA
3	PAILLARD, Karine	FRA		000 sH / 100	2:51

Final Results

1. PAILLARD, Karine FRA
2. VESZI, Klara HUN
3. LEVIN, Janna USA
- 3.



Veterans World Judo Championships 2016

(USA Fort Lauderdale, 18-21 November 2016)

F3 -70 kg

3 Judoka

			1	2	3			
1	SZABO, Szilvia	HUN		-	+	10	1 (10)	
2	SEGAIN, Murielle	FRA	+		+	10	2 (20)	
3	BATMUNKH, Bolortsatsral	MGL	-	-			0 (0)	

1	SZABO, Szilvia	HUN	1	SEGAIN, Murielle	FRA
2	SEGAIN, Murielle	FRA		000 / 100	2:24

1	SZABO, Szilvia	HUN	2	SZABO, Szilvia	HUN
3	BATMUNKH, Bolortsatsral	MGL		101 s1 / 000	2:15

2	SEGAIN, Murielle	FRA	3	SEGAIN, Murielle	FRA
3	BATMUNKH, Bolortsatsral	MGL		100 / 000	2:50

Final Results

1. SEGAIN, Murielle FRA
2. SZABO, Szilvia HUN
3. BATMUNKH, Bolortsatsral MGL



Veterans World Judo Championships 2016

(USA Fort Lauderdale, 18-21 November 2016)

F3 -78 kg

6 Judoka

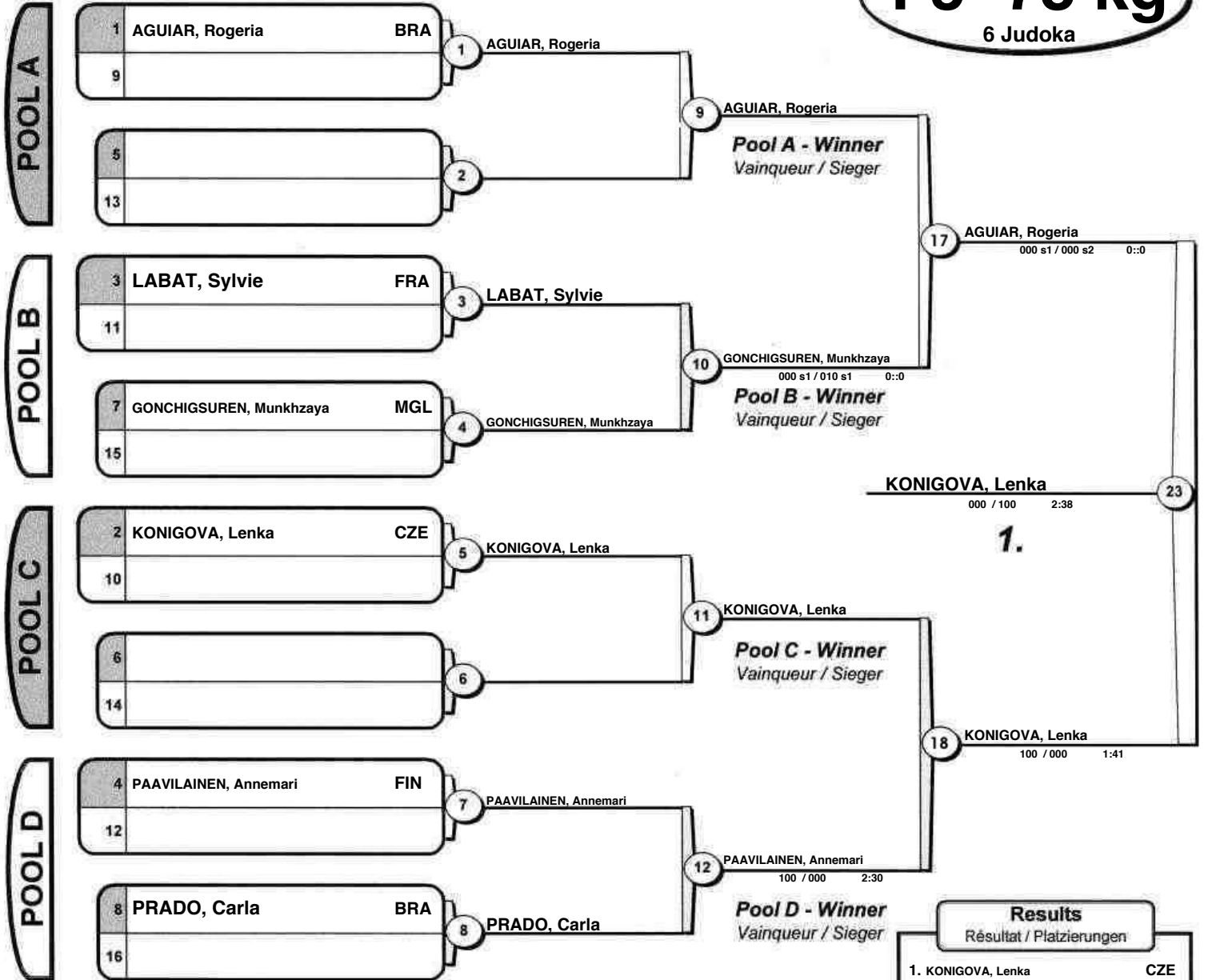

Results	
Résultat / Platzierungen	
1.	KONIGOVA, Lenka CZE
2.	AGUIAR, Rogeria BRA
3.	PAAVILAINEN, Annemari FIN
3.	PRADO, Carla BRA
5.	LABAT, Sylvie FRA
6.	GONCHIGSUREN, Munkhzaya MGL
7.	GONCHIGSUREN, Munkhzaya MGL
7.	GONCHIGSUREN, Munkhzaya MGL

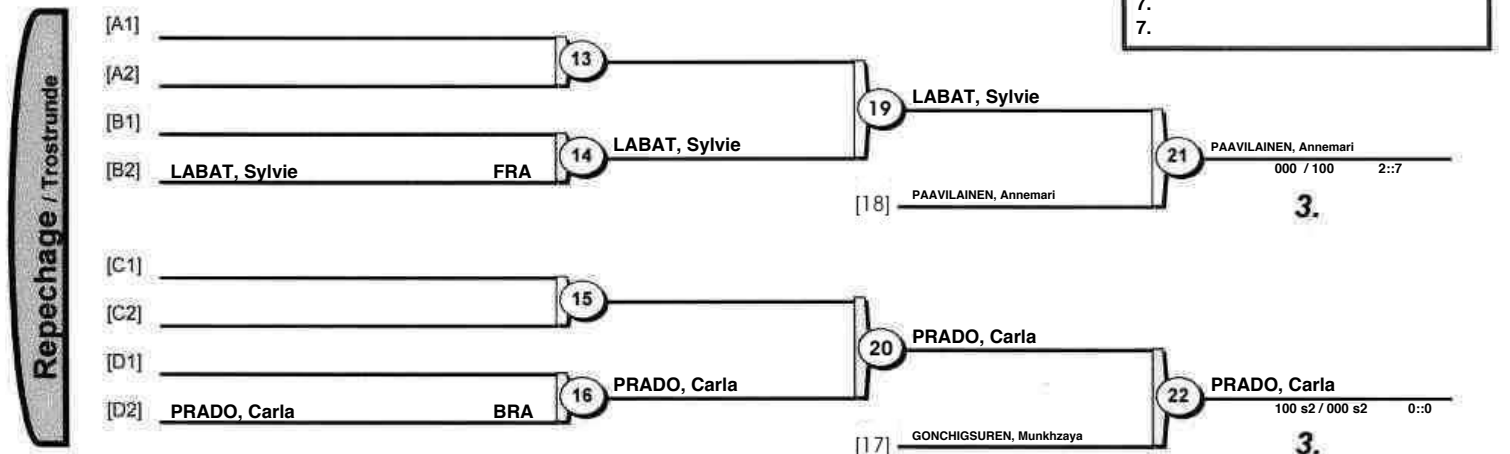



Veterans World Judo Championships 2016

(USA Fort Lauderdale, 18-21 November 2016)

F3 +78 kg

2 Judoka

BEST OF THREE

1	LEGDEN, Bayarmaa	MGL	1	RODRIGUEZ OCANA, Kenia	CRC
2	RODRIGUEZ OCANA, Kenia	CRC		000 s1 / 100	1:30

1	LEGDEN, Bayarmaa	MGL	2	RODRIGUEZ OCANA, Kenia	CRC
2	RODRIGUEZ OCANA, Kenia	CRC		000 s1 / 100	1:51

1	LEGDEN, Bayarmaa	MGL	3	RODRIGUEZ OCANA, Kenia	CRC
2	RODRIGUEZ OCANA, Kenia	CRC		000 / 000 s1	0::0

Final Results

1. RODRIGUEZ OCANA, Kenia CRC
2. LEGDEN, Bayarmaa MGL



Veterans World Judo Championships 2016

(USA Fort Lauderdale, 18-21 November 2016)

F4 -52 kg

2 Judoka

BEST OF THREE

1	RUEHL, Silke	GER	1	MORAES, Maria	BRA	000 / 100	2:32
2	MORAES, Maria	BRA					

1	RUEHL, Silke	GER	2	MORAES, Maria	BRA	000 / 101 s1	1:42
2	MORAES, Maria	BRA					

1	RUEHL, Silke	GER	3	MORAES, Maria	BRA	000 / 000 s1	0::0
2	MORAES, Maria	BRA					

Final Results

1. MORAES, Maria BRA
2. RUEHL, Silke GER



Veterans World Judo Championships 2016

(USA Fort Lauderdale, 18-21 November 2016)

F4 -57 kg

2 Judoka

BEST OF THREE

1	STEREA, Lena	ROU	1	STEREA, Lena	ROU
2	HEIDRICH, Anke	GER		110 / 000	1:18

1	STEREA, Lena	ROU	2	STEREA, Lena	ROU
2	HEIDRICH, Anke	GER		100 / 000 s1	1:12

1	STEREA, Lena	ROU	3	STEREA, Lena	ROU
2	HEIDRICH, Anke	GER		000 s1 / 000	0::0

Final Results

1. STEREA, Lena ROU
2. HEIDRICH, Anke GER



Veterans World Judo Championships 2016

(USA Fort Lauderdale, 18-21 November 2016)

F4 -63 kg

7 Judoka

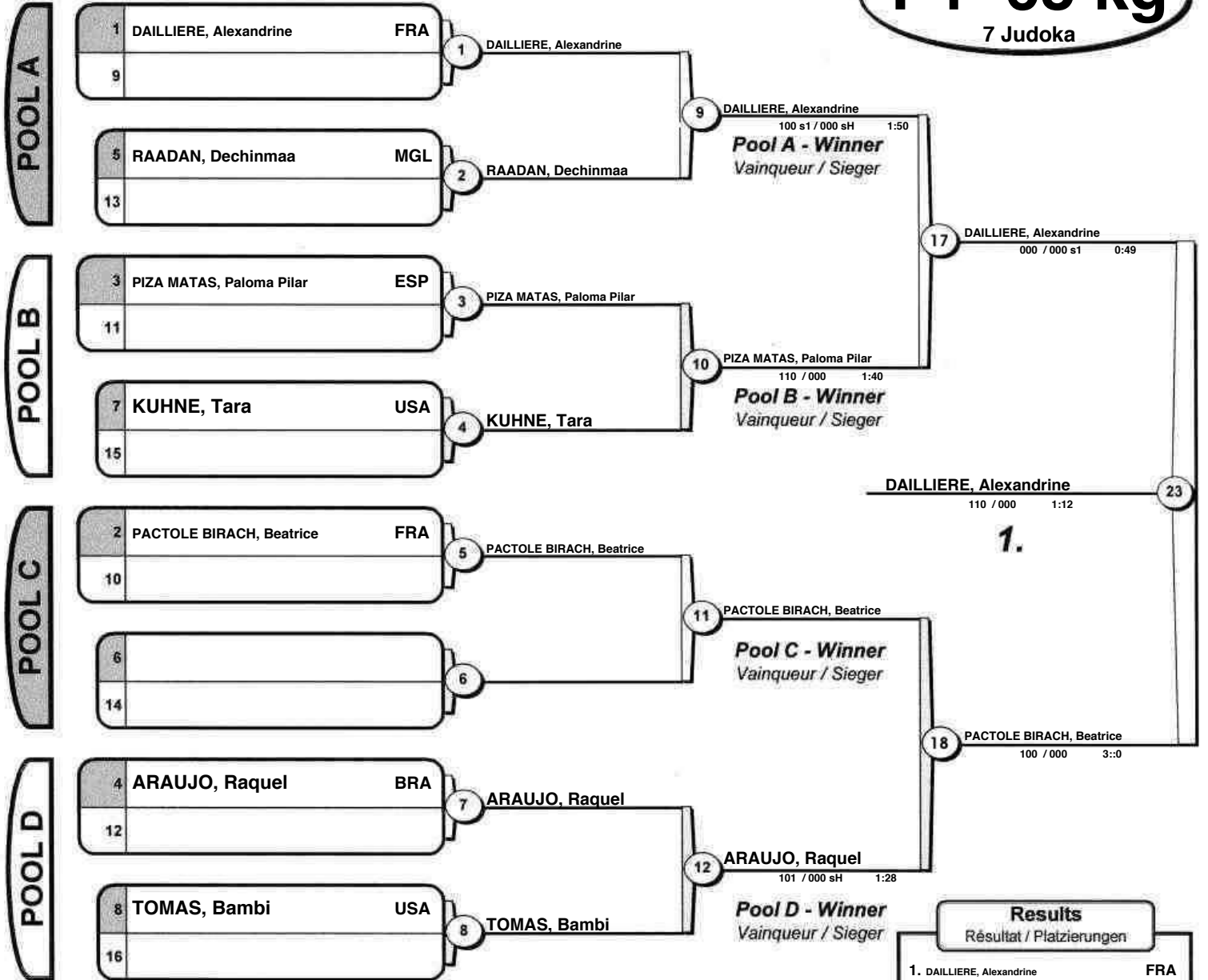

Results		
Résultat / Platzierungen		
1.	DAILLIERE, Alexandrine	FRA
2.	PACTOLE BIRACH, Beatrice	FRA
3.	RAADAN, Dechinmaa	MGL
3.	PIZA MATAS, Paloma Pilar	ESP
5.	ARAUJO, Raquel	BRA
5.	TOMAS, Bambi	USA
7.	KUHNE, Tara	USA

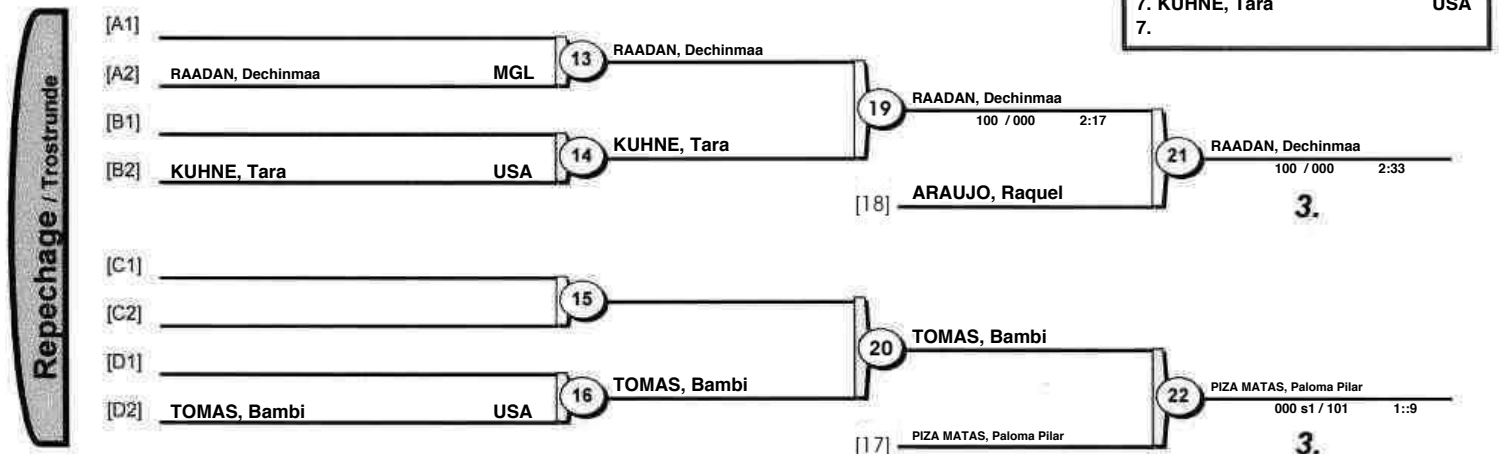



Veterans World Judo Championships 2016

(USA Fort Lauderdale, 18-21 November 2016)

F4 -70 kg

4 Judoka

			1	2	3	4			
1	CABRERA, Margarita	USA		1 (100)	1 (100)	1 (100)	3 (300)		
2	STRAGLIOTTO, Monica	ITA	0		1 (100)	0	1 (100)		
3	CAKIR, Dilek	TUR	0	0		0	(0)		
4	HUSEYNOVA, Zulfiyya	AZE	0	1 (100)	1 (100)		2 (200)		

1	CABRERA, Margarita	USA	1	CABRERA, Margarita	USA
2	STRAGLIOTTO, Monica	ITA		100 / 000	2:49

3	CAKIR, Dilek	TUR	2	HUSEYNOVA, Zulfiyya	AZE
4	HUSEYNOVA, Zulfiyya	AZE		000 / 101	2:17

1	CABRERA, Margarita	USA	3	CABRERA, Margarita	USA
3	CAKIR, Dilek	TUR		100 / 000 s1	2:33

2	STRAGLIOTTO, Monica	ITA	4	HUSEYNOVA, Zulfiyya	AZE
4	HUSEYNOVA, Zulfiyya	AZE		000 s4 / 100 s1	0:17

1	CABRERA, Margarita	USA	5	CABRERA, Margarita	USA
4	HUSEYNOVA, Zulfiyya	AZE		112 s1 / 000	1:24

2	STRAGLIOTTO, Monica	ITA	6	STRAGLIOTTO, Monica	ITA
3	CAKIR, Dilek	TUR		100 / 000	3::0

Final Results

1. CABRERA, Margarita USA
2. HUSEYNOVA, Zulfiyya AZE
3. STRAGLIOTTO, Monica ITA
- 3.



Veterans World Judo Championships 2016

(USA Fort Lauderdale, 18-21 November 2016)

F5 -57 kg

3 Judoka

			1	2	3		
1	BERLINER, Elizabeth	USA		-	-	0 (0)	
2	CATTAL, Enrica	ITA	+		-	1 (10)	
3	STRUBE, Sylvia	GER	+	+		2 (17)	

1	BERLINER, Elizabeth	USA	1	CATTAL, Enrica	ITA
2	CATTAL, Enrica	ITA		000 s4 / 110	2::6

1	BERLINER, Elizabeth	USA	2	STRUBE, Sylvia	GER
3	STRUBE, Sylvia	GER		000 / 100	2:14

2	CATTAL, Enrica	ITA	3	STRUBE, Sylvia	GER
3	STRUBE, Sylvia	GER		000 s2 / 010 s1	0::0

Final Results

- STRUBE, Sylvia GER
- CATTAL, Enrica ITA
- BERLINER, Elizabeth USA



Veterans World Judo Championships 2016

(USA Fort Lauderdale, 18-21 November 2016)

F5 -63 kg

2 Judoka

BEST OF THREE

1	MOOG, Gabi	GER	1	MOOG, Gabi	GER	010 s3 / 000 s1	0::0
2	BORGOGNO, Loredana	ITA					

1	MOOG, Gabi	GER	2	BORGOGNO, Loredana	ITA	000 s2 / 100 s1	0:24
2	BORGOGNO, Loredana	ITA					

1	MOOG, Gabi	GER	3	BORGOGNO, Loredana	ITA	000 s1 / 100 s1	0:10
2	BORGOGNO, Loredana	ITA					

Final Results

1. BORGOGNO, Loredana ITA
2. MOOG, Gabi GER



Veterans World Judo Championships 2016

(USA Fort Lauderdale, 18-21 November 2016)

F5 -70 kg

5 Judoka

			1	2	3	4	5		
1	CALAMO, Aurora	ITA		1 (100)	1 (100)	1 (100)	0	3 (300)	
2	GAMA, Maria	BRA	0		1 (100)	0	0	1 (100)	
3	AUTERSKA, Petra	CZE	0	0		0	0	(0)	
4	MALLEY, Joyce	GBR	0	1 (100)	1 (100)		0	2 (200)	
5	HAARMANN, Andrea	GER	1 (100)	1 (100)	1 (100)	1 (100)		4 (400)	

1	CALAMO, Aurora	ITA	1	CALAMO, Aurora	ITA	
2	GAMA, Maria	BRA		101 / 000	2:19	
3	AUTERSKA, Petra	CZE	2	MALLEY, Joyce	GBR	
4	MALLEY, Joyce	GBR		000 s1 / 102	0::6	
1	CALAMO, Aurora	ITA	3	HAARMANN, Andrea	GER	
5	HAARMANN, Andrea	GER		000 / 100	2:34	
2	GAMA, Maria	BRA	4	GAMA, Maria	BRA	
3	AUTERSKA, Petra	CZE		100 / 000	1:44	
4	MALLEY, Joyce	GBR	5	HAARMANN, Andrea	GER	
5	HAARMANN, Andrea	GER		000 s1 / 100	0:23	
1	CALAMO, Aurora	ITA	6	CALAMO, Aurora	ITA	
3	AUTERSKA, Petra	CZE		101 / 000	2:27	
2	GAMA, Maria	BRA	7	MALLEY, Joyce	GBR	
4	MALLEY, Joyce	GBR		000 s1 / 100	0:29	
3	AUTERSKA, Petra	CZE	8	HAARMANN, Andrea	GER	
5	HAARMANN, Andrea	GER		000 / 101	2::5	
1	CALAMO, Aurora	ITA	9	CALAMO, Aurora	ITA	
4	MALLEY, Joyce	GBR		100 / 000	1:30	
2	GAMA, Maria	BRA	10	HAARMANN, Andrea	GER	
5	HAARMANN, Andrea	GER		000 / 100	2:36	

Final Results

1. HAARMANN, Andrea GER
2. CALAMO, Aurora ITA
3. MALLEY, Joyce GBR
- 3.



Veterans World Judo Championships 2016

(USA Fort Lauderdale, 18-21 November 2016)

F5 -78 kg

3 Judoka

			1	2	3		
1	HOPKINS, Sarah	GBR		+	+	2 (20)	
2	BEERENWINKEL, Klara	GER	-		+	1 (10)	
3	SMITH, Shandra	USA	-	-		0 (0)	

1	HOPKINS, Sarah	GBR	1	HOPKINS, Sarah	GBR
2	BEERENWINKEL, Klara	GER			

1	HOPKINS, Sarah	GBR	2	HOPKINS, Sarah	GBR
3	SMITH, Shandra	USA			

2	BEERENWINKEL, Klara	GER	3	BEERENWINKEL, Klara	GER
3	SMITH, Shandra	USA			

Final Results

- HOPKINS, Sarah GBR
- BEERENWINKEL, Klara GER
- SMITH, Shandra USA



Veterans World Judo Championships 2016

(USA Fort Lauderdale, 18-21 November 2016)

F5 +78 kg

3 Judoka

			1	2	3		
1	SILVA, Rogeria	BRA		+	+	2 (8)	
2	SILVA, Iraci	BRA	-		-	0 (0)	
3	SOKOL, Susan	CAN	-	+		1 (10)	

1	SILVA, Rogeria	BRA	1	SILVA, Rogeria	BRA
2	SILVA, Iraci	BRA		000 s1 / 000 s2	0:42

1	SILVA, Rogeria	BRA	2	SILVA, Rogeria	BRA
3	SOKOL, Susan	CAN		010 / 000 s1	0::0

2	SILVA, Iraci	BRA	3	SOKOL, Susan	CAN
3	SOKOL, Susan	CAN		000 / 100	2:12

Final Results

- SILVA, Rogeria BRA
- SOKOL, Susan CAN
- SILVA, Iraci BRA



Veterans World Judo Championships 2016

(USA Fort Lauderdale, 18-21 November 2016)

F6 -52 kg

2 Judoka

BEST OF THREE

1	MYRNES, Hanne	NOR	1	MYRNES, Hanne	NOR	010 s2 / 000 s1	0::0
2	ASSIRELLI, Lucia	ITA					

1	MYRNES, Hanne	NOR	2	MYRNES, Hanne	NOR	100 / 000	2:17
2	ASSIRELLI, Lucia	ITA					

1	MYRNES, Hanne	NOR	3	MYRNES, Hanne	NOR	000 s1 / 000	0::0
2	ASSIRELLI, Lucia	ITA					

Final Results

1. MYRNES, Hanne NOR
2. ASSIRELLI, Lucia ITA



Veterans World Judo Championships 2016

(USA Fort Lauderdale, 18-21 November 2016)

F6 -63 kg

2 Judoka

BEST OF THREE

1	LE BRUN, Brigitte	FRA	1	LE BRUN, Brigitte	FRA
2	DANJOUX, Benedicte	FRA		112 / 010	1:42

1	LE BRUN, Brigitte	FRA	2	LE BRUN, Brigitte	FRA
2	DANJOUX, Benedicte	FRA		100 / 000	3::0

1	LE BRUN, Brigitte	FRA	3	LE BRUN, Brigitte	FRA
2	DANJOUX, Benedicte	FRA		000 s1 / 000	0::0

Final Results

1. LE BRUN, Brigitte FRA
2. DANJOUX, Benedicte FRA



Veterans World Judo Championships 2016

(USA Fort Lauderdale, 18-21 November 2016)

F6 -70 kg

3 Judoka

			1	2	3		
1	HEMINGWAY, Tamara	USA		+	+	2 (15)	
2	CAMARGO, Fatima	BRA	-		+	1 (10)	
3	PEUCH, Christine	FRA	-	-		0 (0)	

1	HEMINGWAY, Tamara	USA	1	HEMINGWAY, Tamara	USA
2	CAMARGO, Fatima	BRA		001 / 000 s2	0::0

1	HEMINGWAY, Tamara	USA	2	HEMINGWAY, Tamara	USA
3	PEUCH, Christine	FRA		100 / 000	3::0

2	CAMARGO, Fatima	BRA	3	CAMARGO, Fatima	BRA
3	PEUCH, Christine	FRA		100 / 000	3::0

Final Results

- HEMINGWAY, Tamara USA
- CAMARGO, Fatima BRA
- PEUCH, Christine FRA



Veterans World Judo Championships 2016

(USA Fort Lauderdale, 18-21 November 2016)

F6 -78 kg

3 Judoka

			1	2	3		
1	ANDREWS, Kay	GBR		+	+	2 (11)	
2	HUTCHINS, Lesley	GBR	-		+	1 (10)	
3	KAYALI, Ayse	TUR	-	-		0 (0)	

1	ANDREWS, Kay	GBR	1	ANDREWS, Kay	GBR
2	HUTCHINS, Lesley	GBR		000 / 000 s3	0::0

1	ANDREWS, Kay	GBR	2	ANDREWS, Kay	GBR
3	KAYALI, Ayse	TUR		100 / 000	2:11

2	HUTCHINS, Lesley	GBR	3	HUTCHINS, Lesley	GBR
3	KAYALI, Ayse	TUR		101 / 000	1:26

Final Results

- ANDREWS, Kay GBR
- HUTCHINS, Lesley GBR
- KAYALI, Ayse TUR



Veterans World Judo Championships 2016

(USA Fort Lauderdale, 18-21 November 2016)

F8 -78 kg

2 Judoka

BEST OF THREE

1	PALLAVICINO, Cristiana	ITA	1	DUFRESNE, Françoise	FRA	000 s2 / 000 s1	0::0
2	DUFRESNE, Françoise	FRA					

1	PALLAVICINO, Cristiana	ITA	2	DUFRESNE, Françoise	FRA	000 s1 / 000	0::0
2	DUFRESNE, Françoise	FRA					

1	PALLAVICINO, Cristiana	ITA	3	DUFRESNE, Françoise	FRA	000 / 000 s1	0::0
2	DUFRESNE, Françoise	FRA					

Final Results

1. DUFRESNE, Françoise FRA
2. PALLAVICINO, Cristiana ITA

