



# Junior European Judo Cup Leibnitz 2017

(AUT Leibnitz, 3-4 June 2017)

## -55 kg

24 Judoka

POOL A

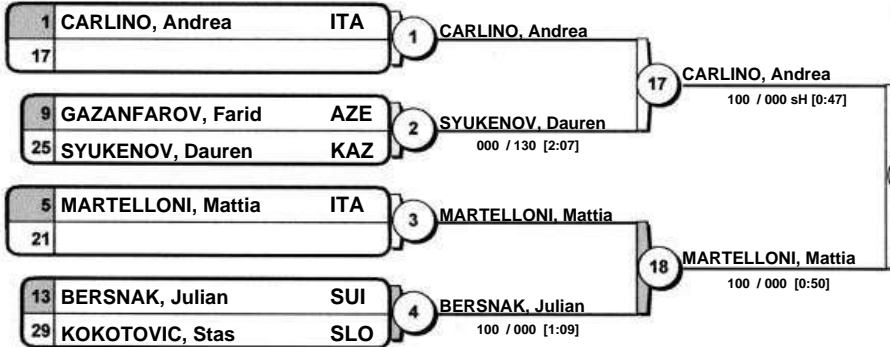

**Pool A - Winner**  
Vainqueur / Sieger

POOL B

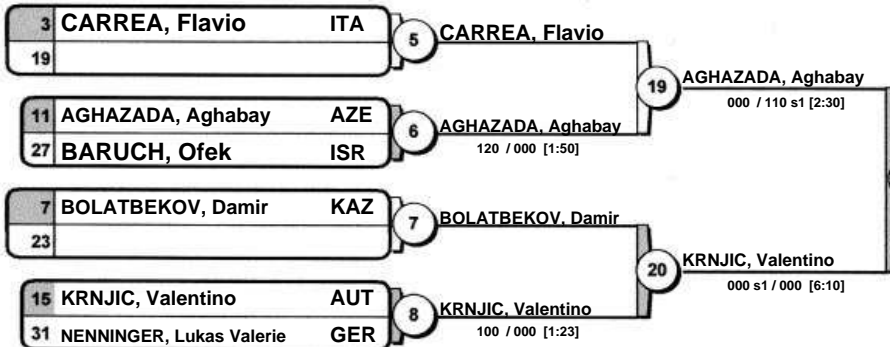

**Pool B - Winner**  
Vainqueur / Sieger

POOL C



**Pool C - Winner**  
Vainqueur / Sieger

POOL D



**Pool D - Winner**  
Vainqueur / Sieger

CARLINO, Andrea

37 CARLINO, Andrea  
110 / 000 s1 [3:56]

1.

38 SHERIEV, Murtaz  
100 / 000 sH [2:11]

**Results**  
Résultat / Platzierungen

- CARLINO, Andrea ITA
- SHERIEV, Murtaz RUS
- NARBAYEV, Bauyrzhan KAZ
- MONORI, Daniel HUN
- SYUKENOV, Dauren KAZ
- AGHAZADA, Aghabay AZE
- KRNJIC, Valentino AUT
- DI CLEMENTE, Alessio ITA

Repechage / Trostrunde

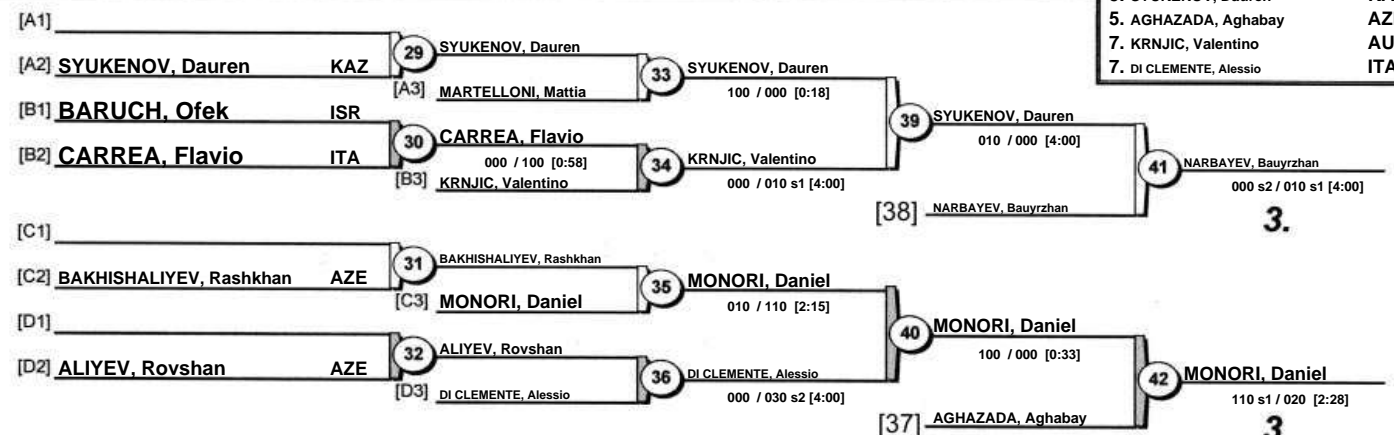

3.

3.



# Junior European Judo Cup Leibnitz 2017

(AUT Leibnitz, 3-4 June 2017)

## -60 kg

45 Judoka

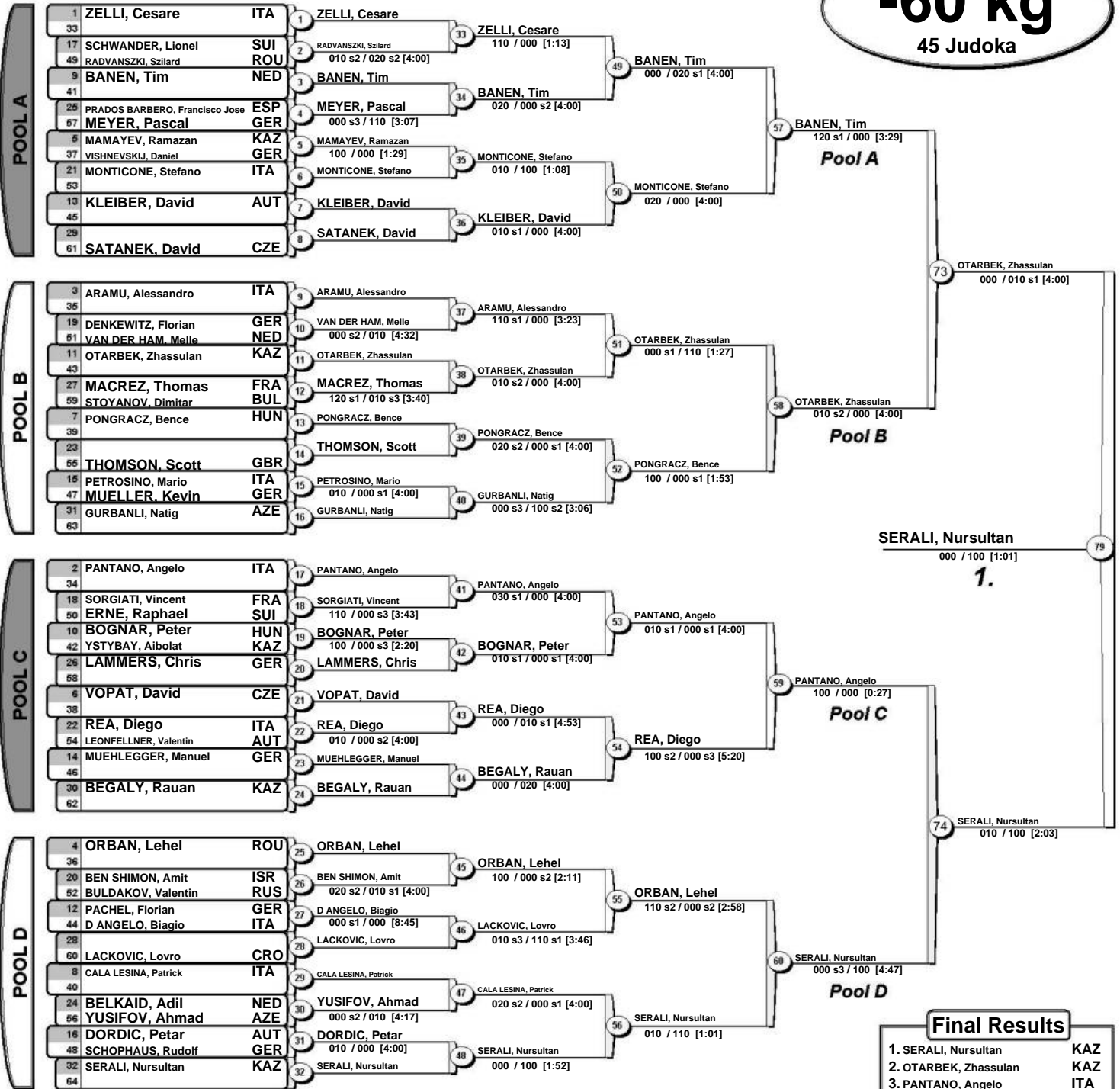

## Repechage

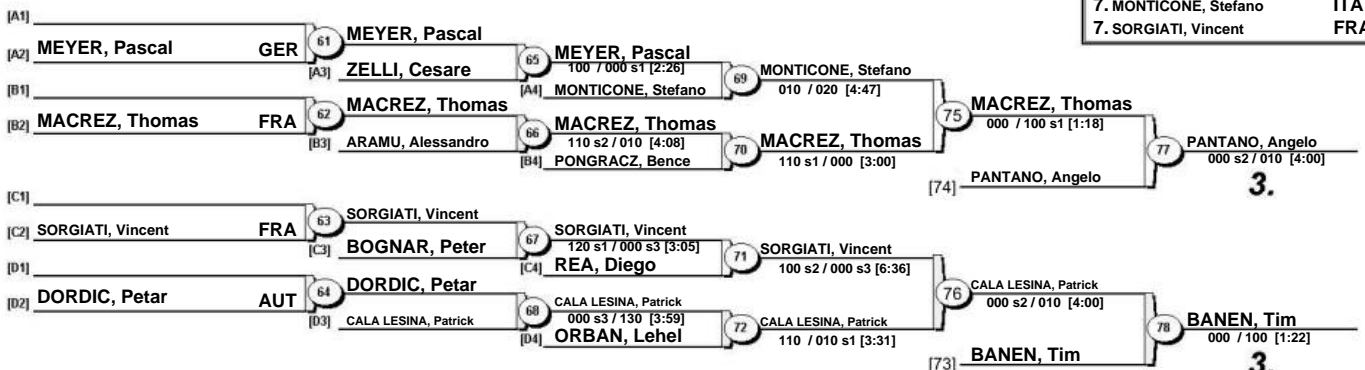



# Junior European Judo Cup Leibnitz 2017

(AUT Leibnitz, 3-4 June 2017)

## -66 kg

55 Judoka

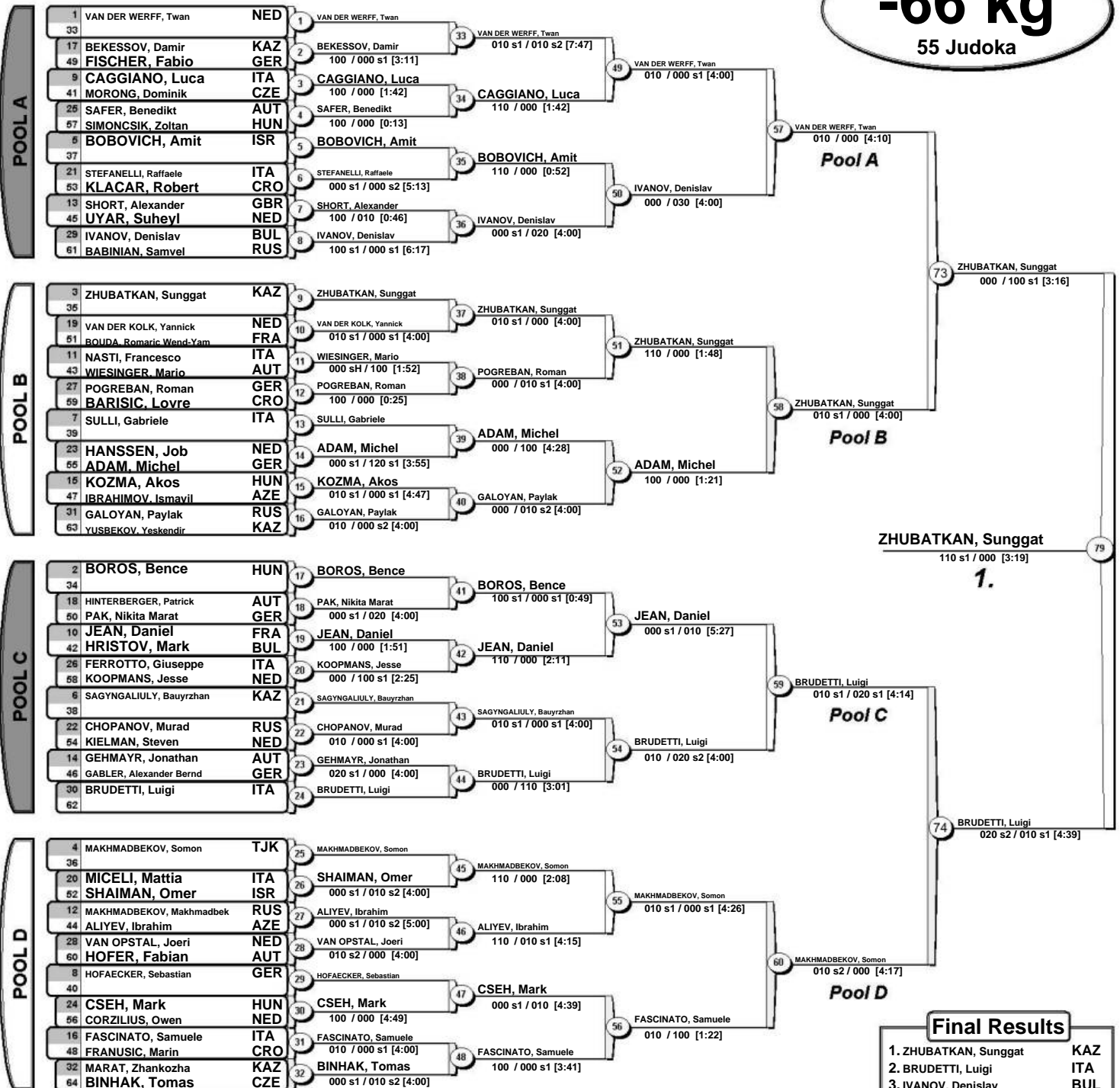

## Repechage

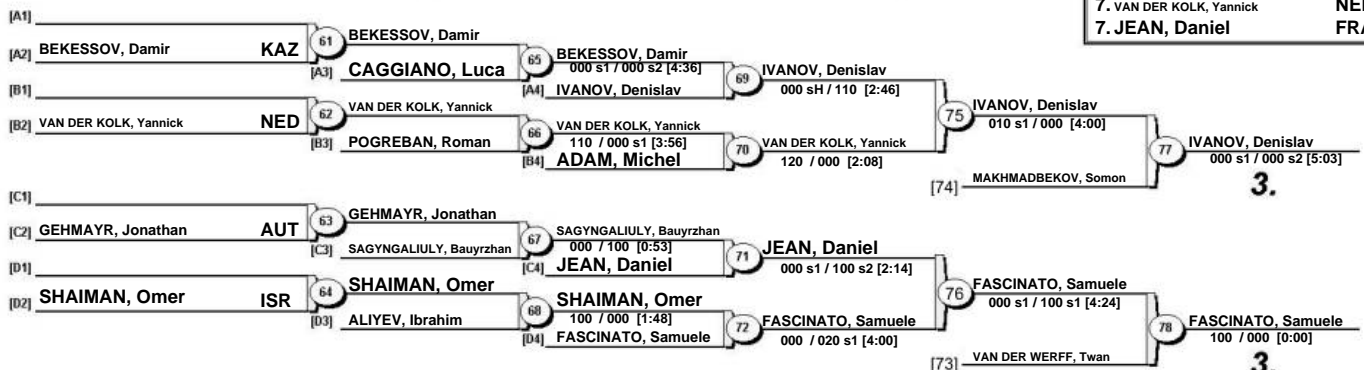



# Junior European Judo Cup Leibnitz 2017

(AUT Leibnitz, 3-4 June 2017)

## -73 kg

61 Judoka

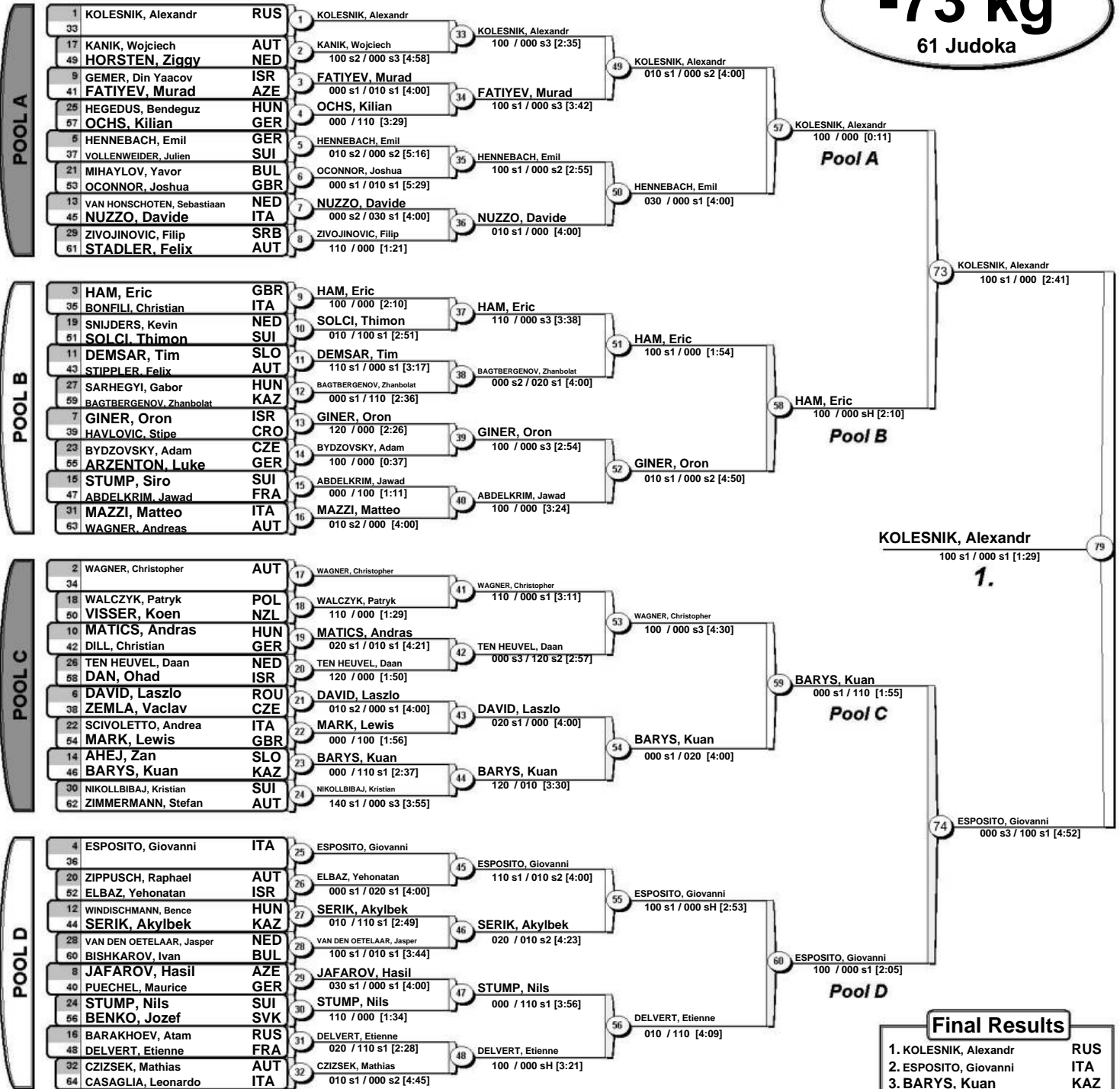

## Repechage

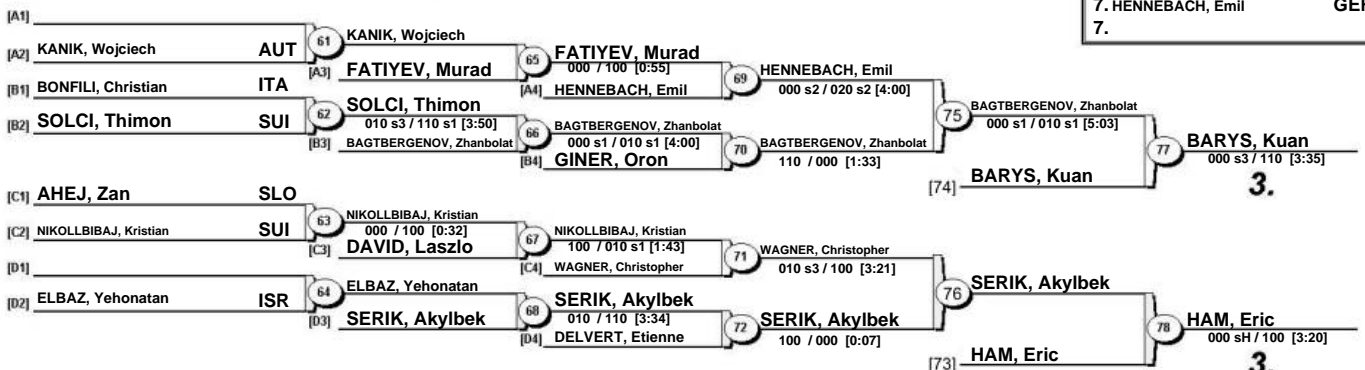



# Junior European Judo Cup Leibnitz 2017

(AUT Leibnitz, 3-4 June 2017)

## -81 kg

45 Judoka

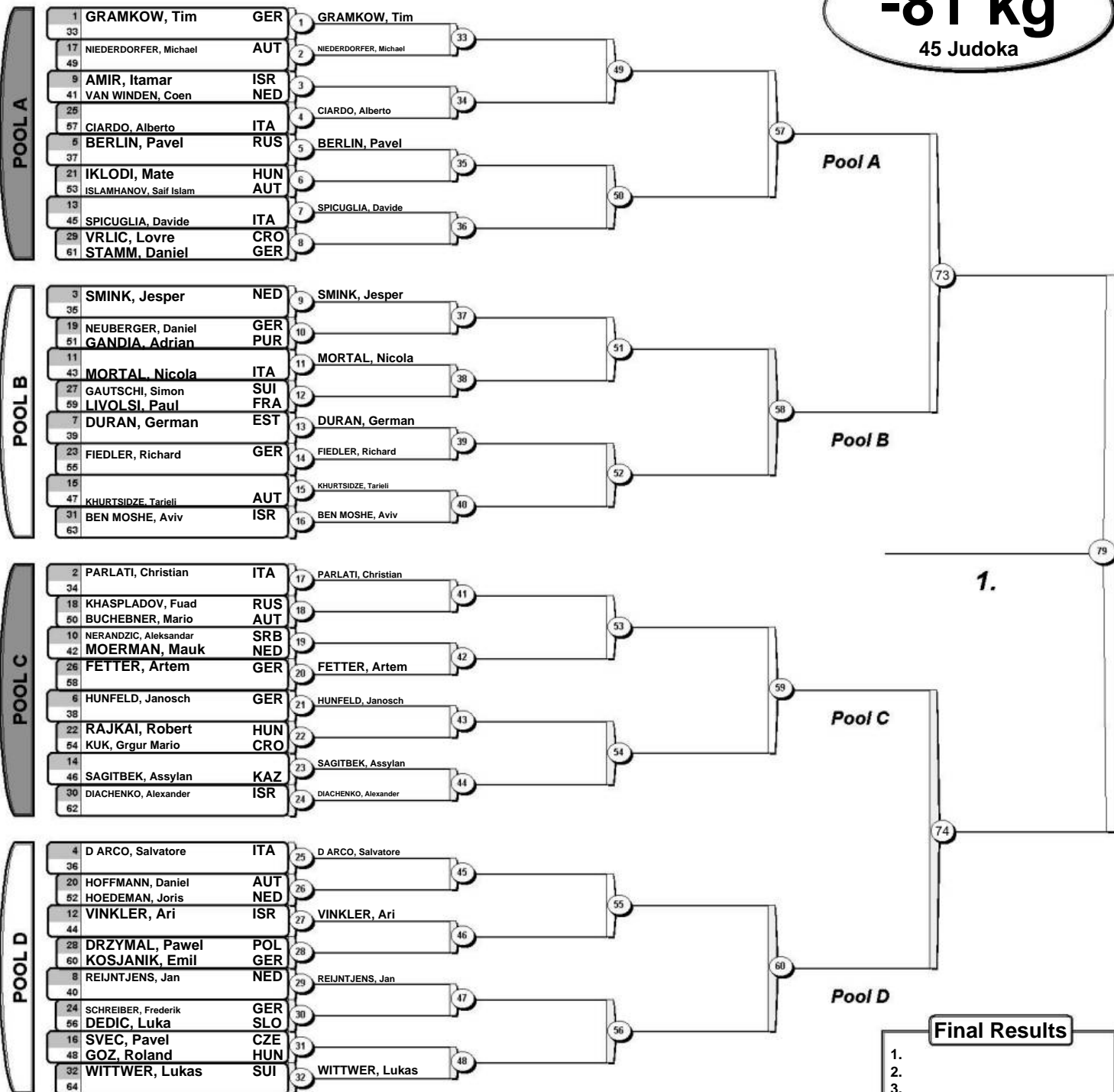

## Repechage

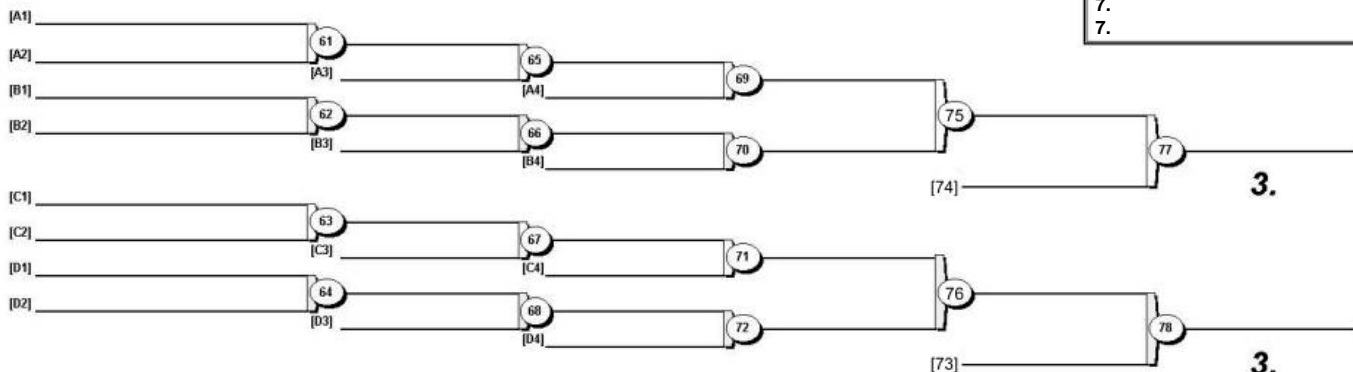



# Junior European Judo Cup Leibnitz 2017

(AUT Leibnitz, 3-4 June 2017)

## -90 kg

30 Judoka

POOL A

1	TRIPPEL, Eduard	GER	1	TRIPPEL, Eduard
17				17
9	BONESHANSKER, Tom	NED	2	
25	RYSSYMBEK, Dinakhmet	KAZ		
5	SCHMIDT, Tim	GER	3	
21	TANGANELLI, Lorenzo	ITA		18
13	ZIVKOVIC BOKURINA, Jere	CRO	4	
29	SARECZ, Marton	HUN		

Pool A - Winner  
Vainqueur / Sieger

POOL B

3	BLAHUSIAK, Miroslav	SVK	5	
19	MOUZAEV, Achmed	CZE		19
11	KOSTOEV, Dzhafar	RUS	6	
27	BEUTING, Bas	NED		
7	TASSIER, Loris	FRA	7	
23	IMRIE, Del	GBR		20
15	HORVAT, Jan	SLO	8	
31	SCHNEIDER, Sebastian	AUT		

Pool B - Winner  
Vainqueur / Sieger

POOL C

2	PETGRAVE, Jamal	GBR	9	PETGRAVE, Jamal
18				21
10	VAN DE VEN, Martijn	NED	10	
26	FUSCO, Andrea	ITA		
6	BRASNJOVIC, Darko	SRB	11	
22	HUSZAR, Martin	HUN		22
14	SUFAJ, Ardian	CRO	12	
30	GOLAN, Itay	ISR		

Pool C - Winner  
Vainqueur / Sieger

POOL D

4	TAIMAZOV, Inal	RUS	13	
20	VERES, Marton	HUN		23
12	BAIAZID, Majed	GER	14	
28	REGONESI, Alessandro	ITA		
8	YAGUBOV, Azar	AZE	15	
24	KOKEZA, Josip	CRO		24
16	MILETIC, Toni	BIH	16	
32	DE VOS, Raymon	NED		

Pool D - Winner  
Vainqueur / Sieger

1.

Results  
Résultat / Platzierungen

- 1.
- 2.
- 3.
- 3.
- 5.
- 7.
- 7.

Repechage / Trostrunde

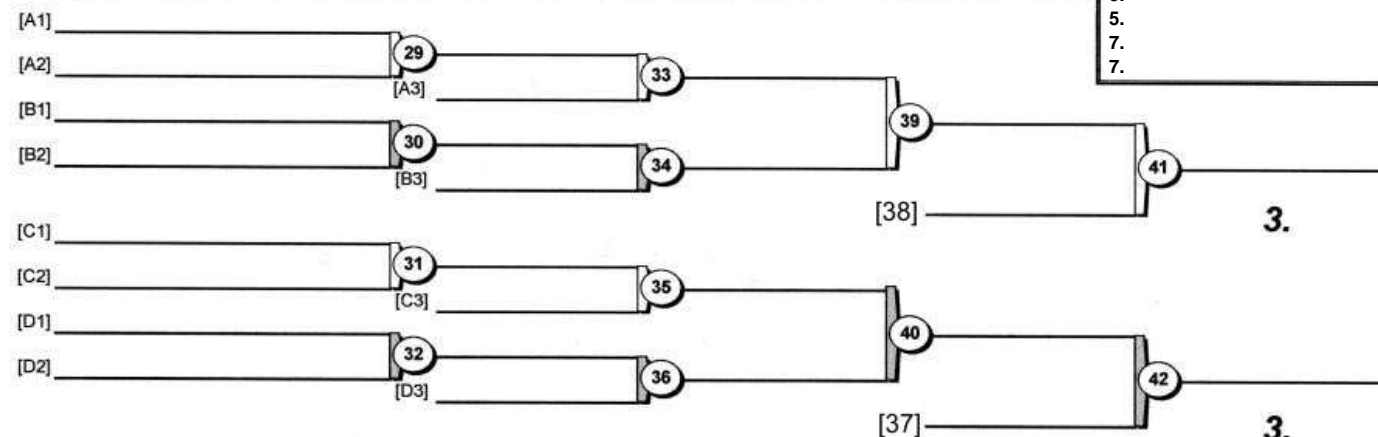



# Junior European Judo Cup Leibnitz 2017

(AUT Leibnitz, 3-4 June 2017)

## -100 kg

20 Judoka

POOL A

1	FARA, Aaron	AUT	1	FARA, Aaron
17			17	
9	SAJHER, Denis	SLO	2	SAJHER, Denis
25			25	
5	CALDER, Cailin	GBR	3	CALDER, Cailin
21			18	
13	ARVAI, Peter	HUN	4	
29	VILLANOVA, Luca	ITA		

Pool A - Winner  
Vainqueur / Sieger

POOL B

3	MAJOWSKI, Dominik	POL	5	MAJOWSKI, Dominik
19			19	
11	SHAKARALIYEV, Musa	AZE	6	SHAKARALIYEV, Musa
27			26	
7	ZORN, Daniel	GER	7	ZORN, Daniel
23			20	
15	FIZEL, Marius	SVK	8	
31	WURTH, Max	NED		

Pool B - Winner  
Vainqueur / Sieger

POOL C

2	CATHARINA, Simeon	NED	9	CATHARINA, Simeon
18			21	
10	HOMO, Nicolas	FRA	10	
26	TRUSNOVEC, Gasper	SLO		
6	DRILLER, Viktor	GER	11	DRILLER, Viktor
22			22	
14			12	WILLNAUER, Alexander
30	WILLNAUER, Alexander	AUT		

Pool C - Winner  
Vainqueur / Sieger

POOL D

4	IMALA, Otto	SUI	13	IMALA, Otto
20			23	
12	LAHBOUB, Mohammed	ITA	14	
28	KOCHAN, Jozsef	HUN		
8	PLESHAKOV, Vitalii	RUS	15	PLESHAKOV, Vitalii
24			24	
16	JERLAGIC, Hadis	BIH	16	JERLAGIC, Hadis
32				

Pool D - Winner  
Vainqueur / Sieger

1.

Results  
Résultat / Platzierungen

- 1.
- 2.
- 3.
- 3.
- 5.
- 7.
- 7.

Repechage / Trostrunde

[A1]		29		33		
[A2]			[A3]			
[B1]					39	
[B2]		30		34		41
[B3]			[B3]			
[C1]					[38]	
[C2]		31		35		
[C3]			[C3]			
[D1]					40	
[D2]		32		36		42
[D3]			[D3]			

3.

3.



# Junior European Judo Cup Leibnitz 2017

(AUT Leibnitz, 3-4 June 2017)

## +100 kg

18 Judoka

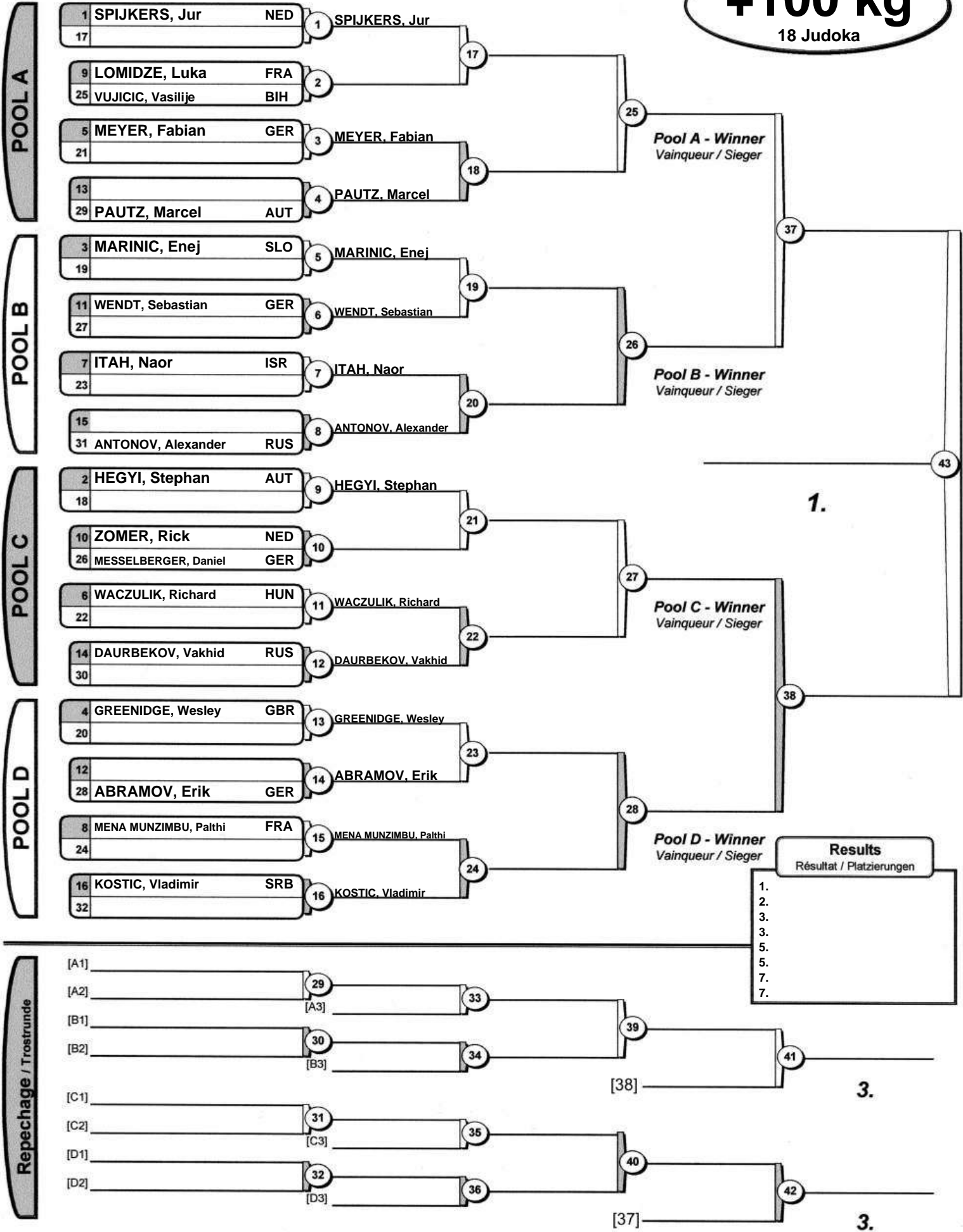





# Junior European Judo Cup Leibnitz 2017

(AUT Leibnitz, 3-4 June 2017)

## -44 kg

10 Judoka

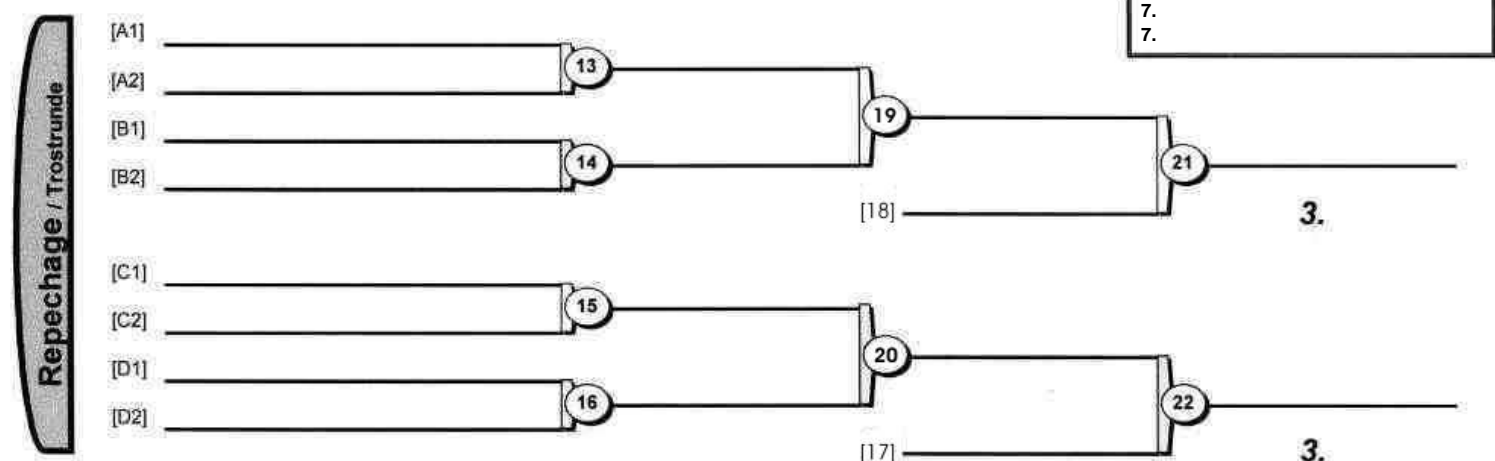
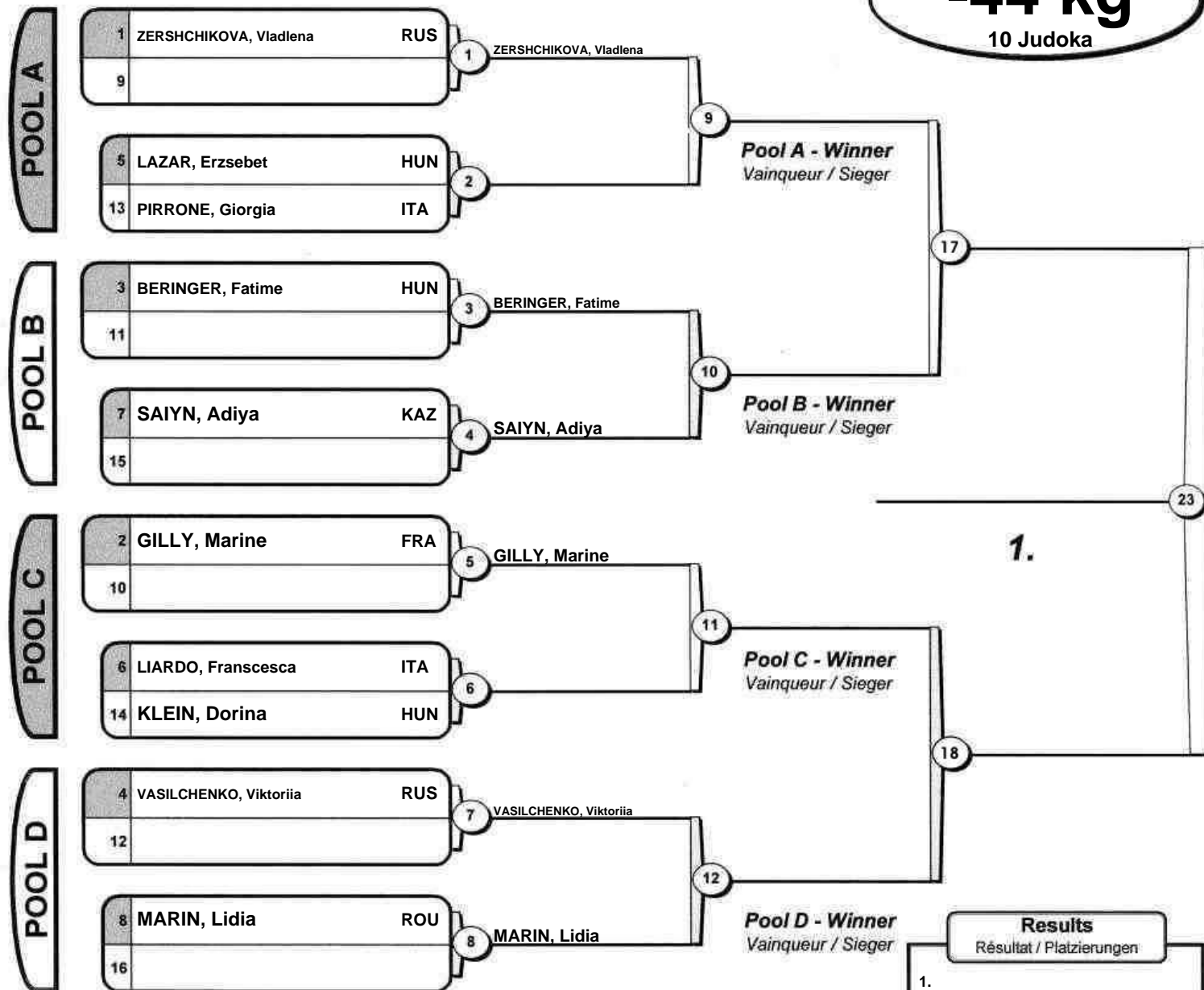



# Junior European Judo Cup Leibnitz 2017

(AUT Leibnitz, 3-4 June 2017)

## -48 kg

24 Judoka

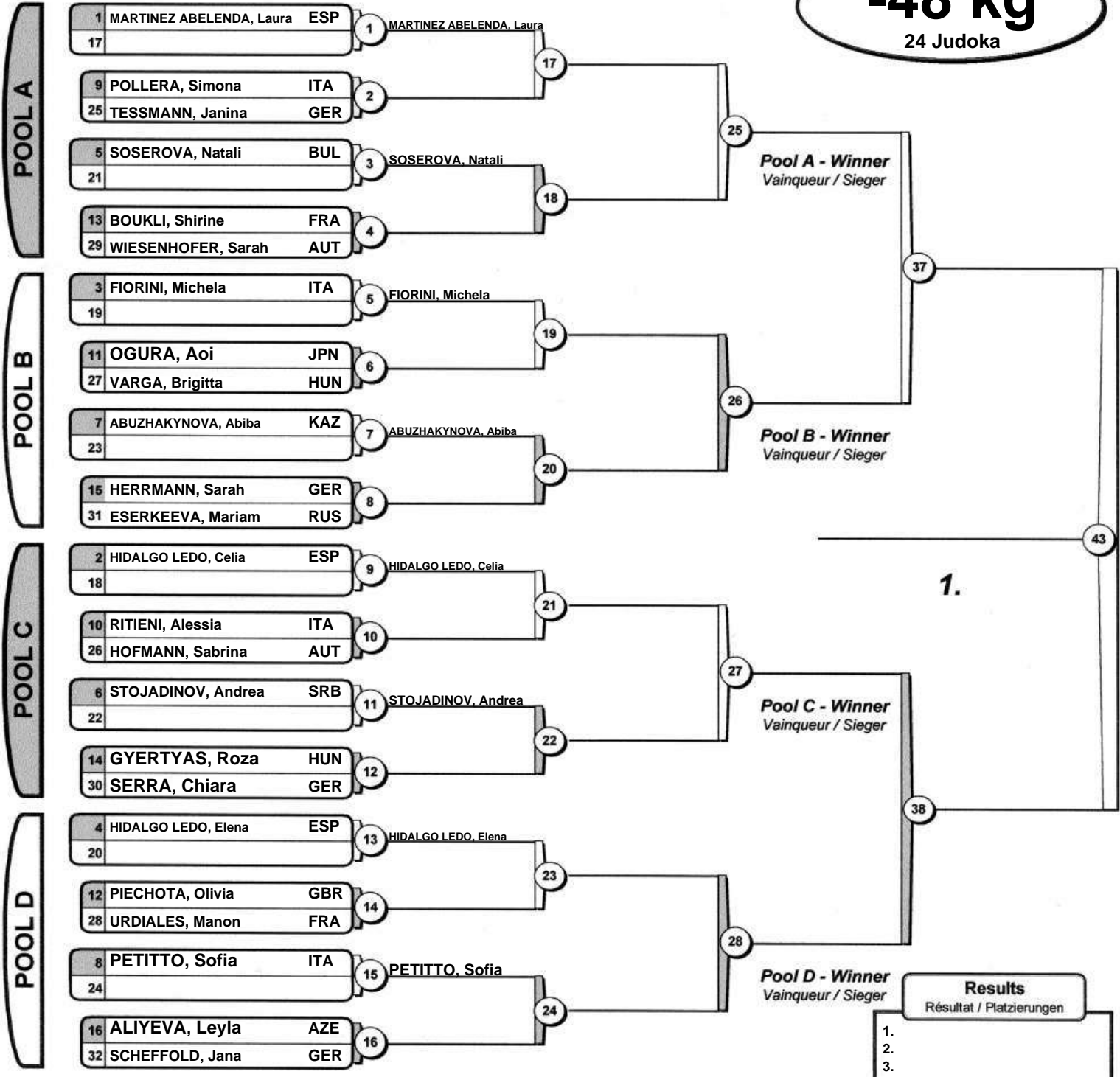

43

1.

38

**Results**  
Résultat / Platzierungen

- 1.
- 2.
- 3.
- 3.
- 5.
- 5.
- 7.
- 7.

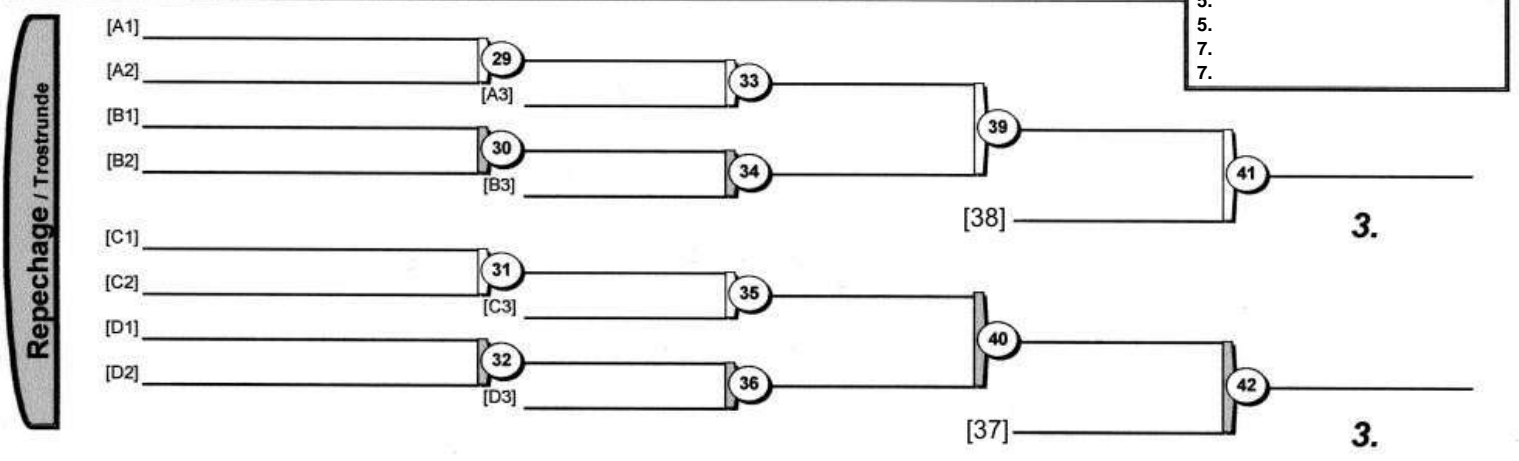



# Junior European Judo Cup Leibnitz 2017

(AUT Leibnitz, 3-4 June 2017)

## -52 kg

35 Judoka

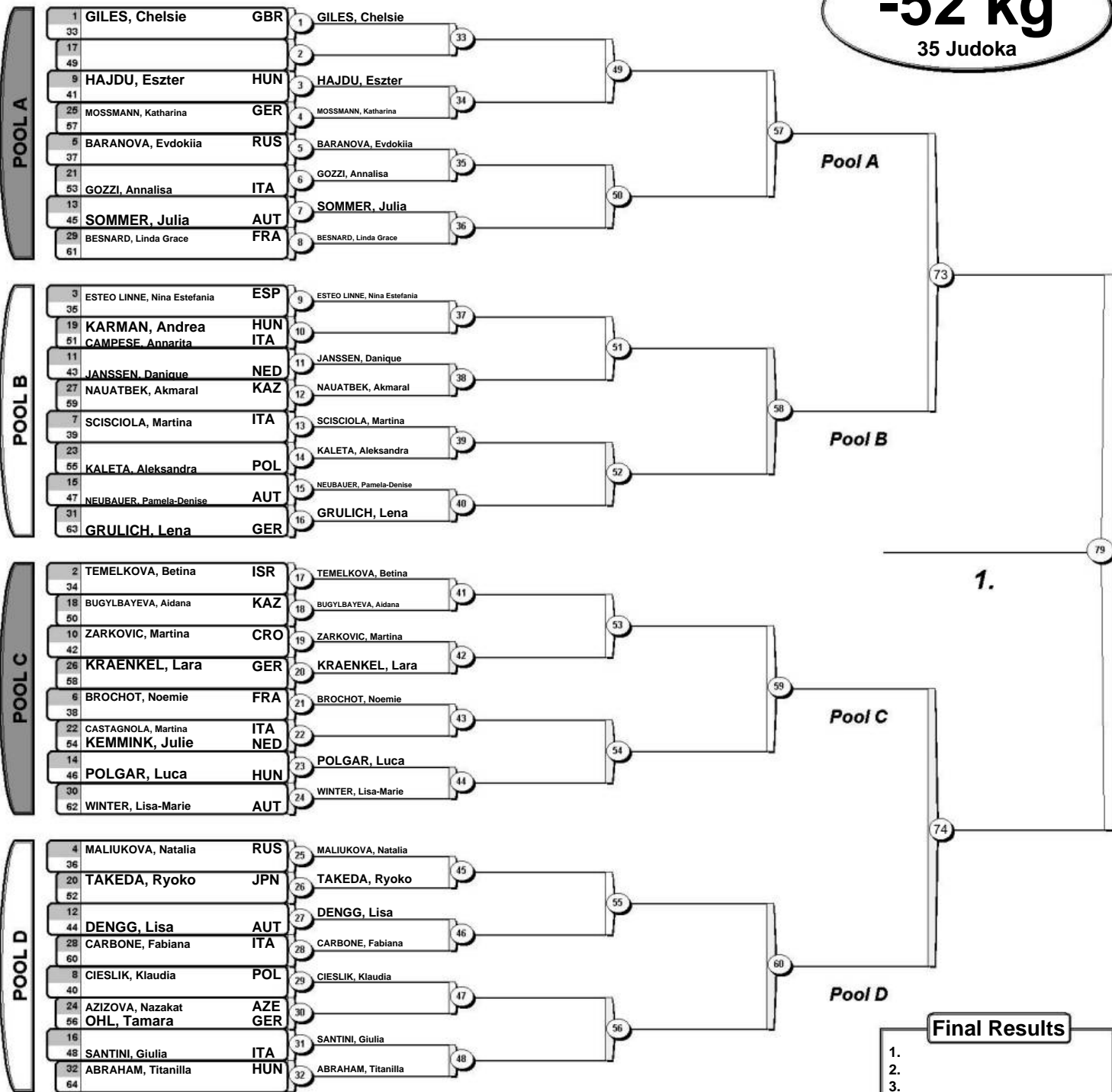

## Repechage

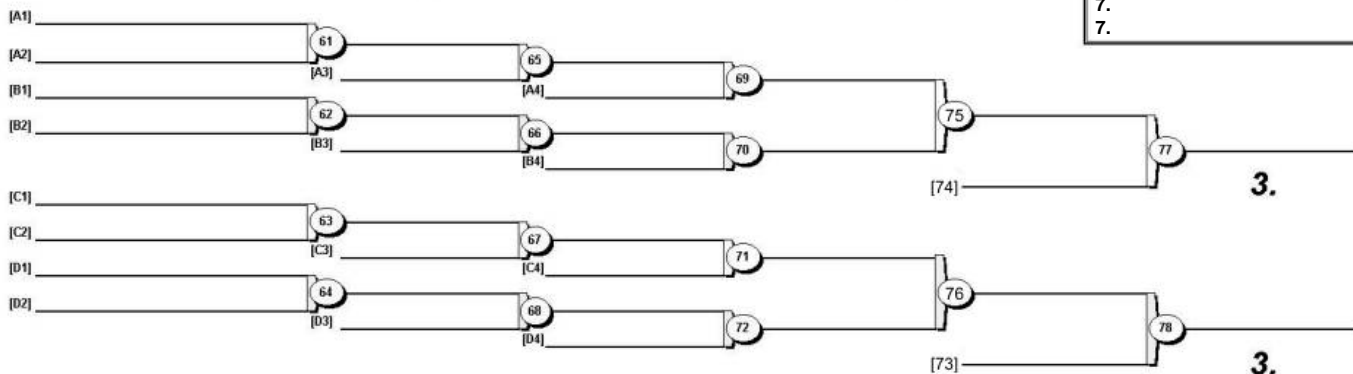



# Junior European Judo Cup Leibnitz 2017

(AUT Leibnitz, 3-4 June 2017)

## -57 kg

48 Judoka

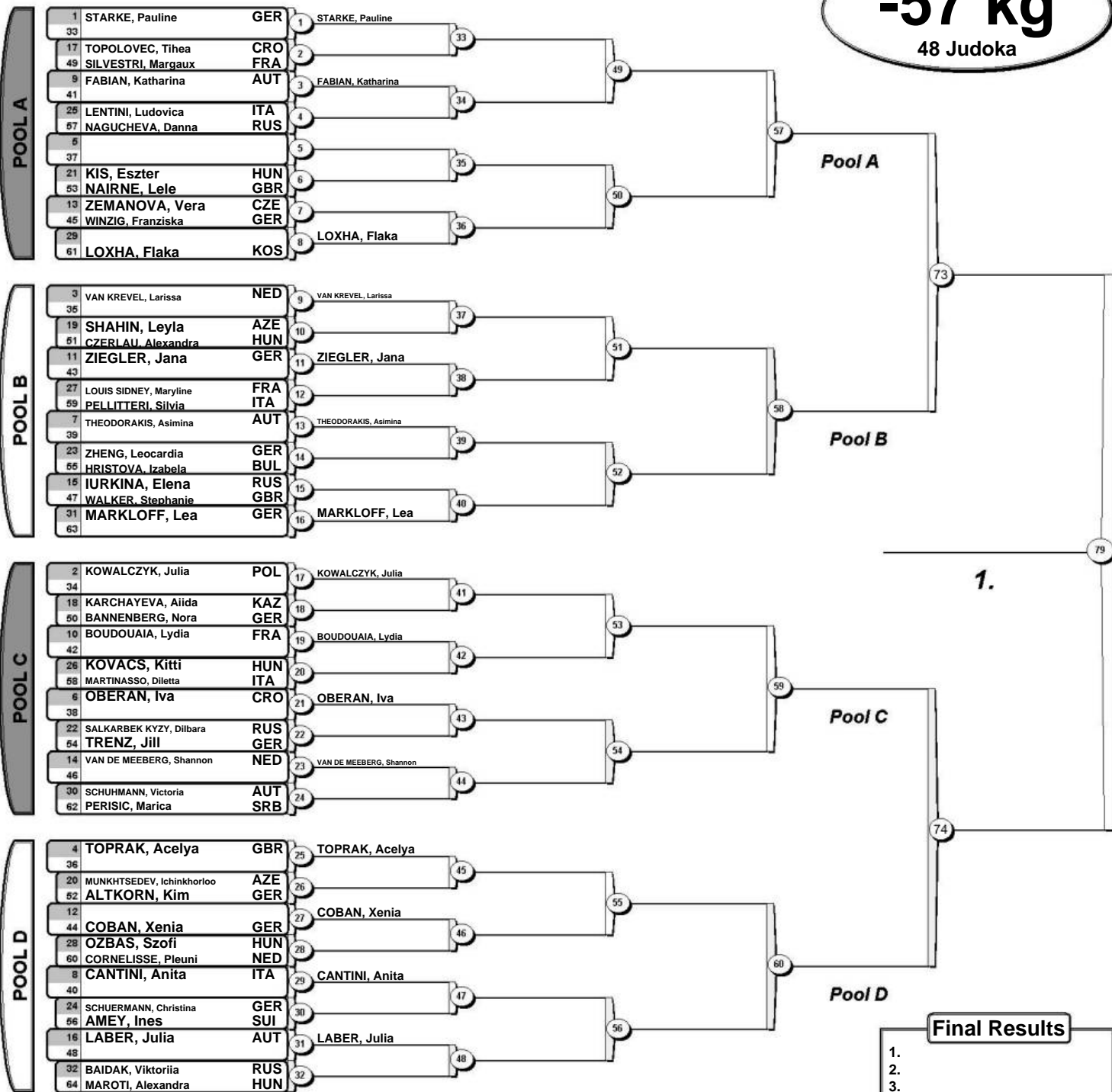

### Repechage

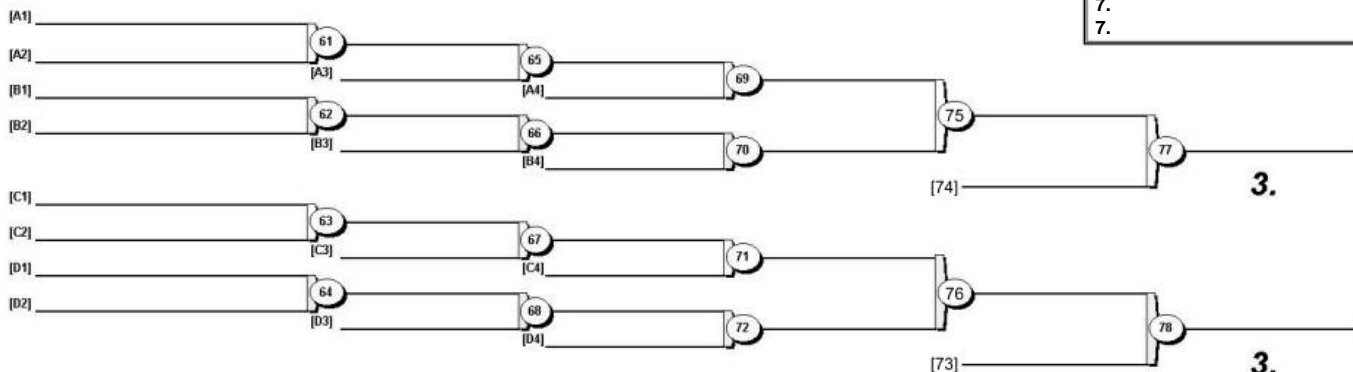



# Junior European Judo Cup Leibnitz 2017

(AUT Leibnitz, 3-4 June 2017)

## -63 kg

39 Judoka

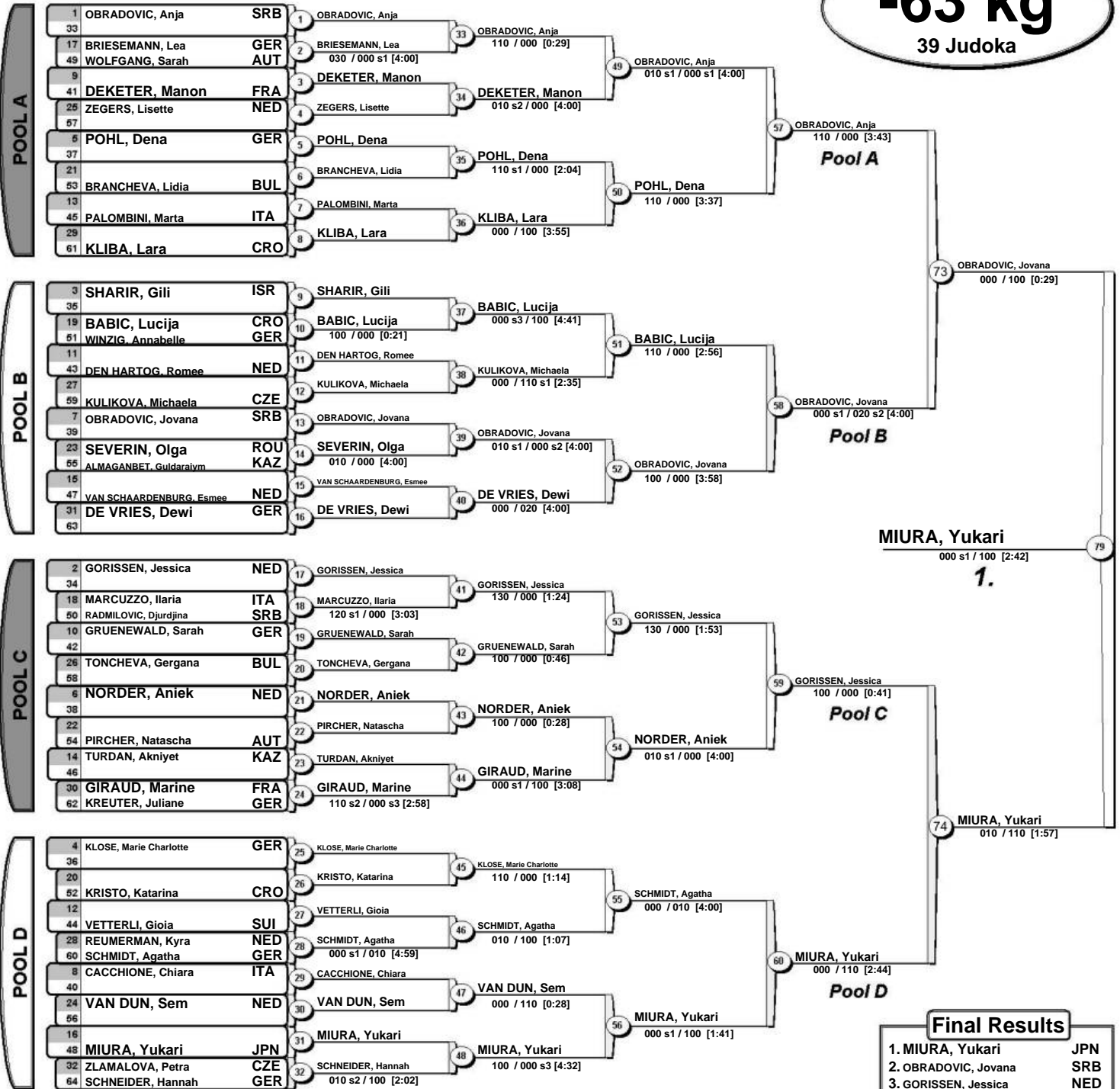

## Repechage

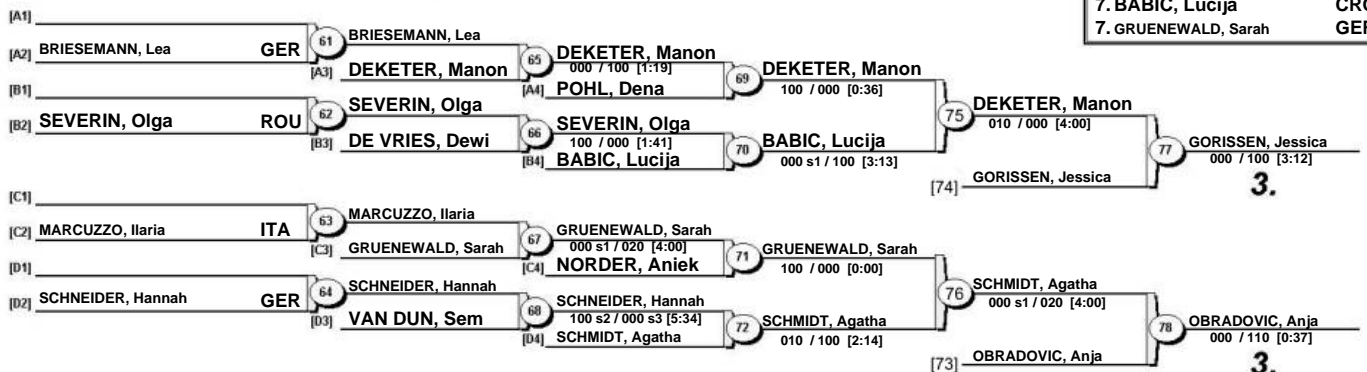



# Junior European Cup Leibnitz 2017

(AUT Leibnitz, 3-4 June 2017)

## -70 kg

25 Judoka

POOL A

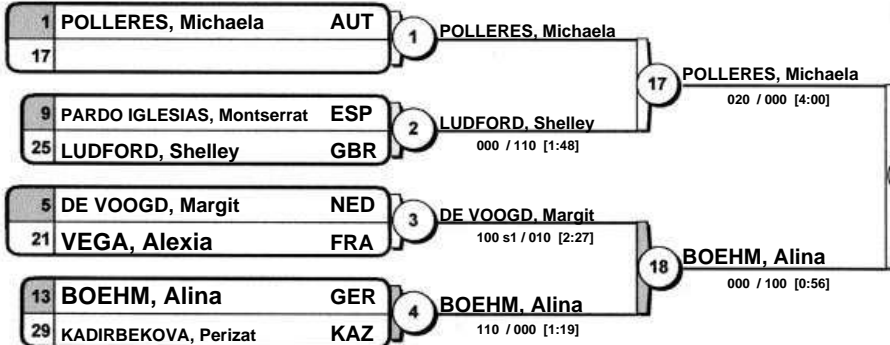

POOL B



POOL C

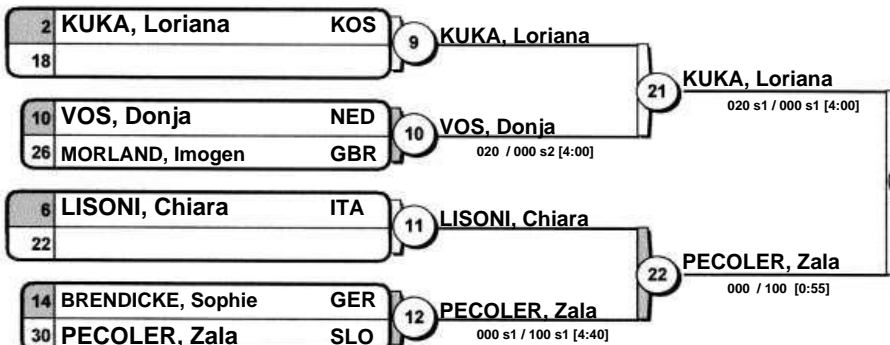

POOL D

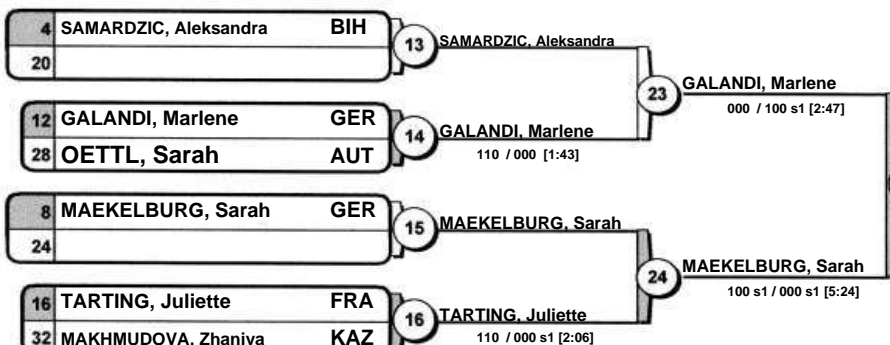

POLLERES, Michaela

37 POLLERES, Michaela  
010 / 000 [6:09]

43 POLLERES, Michaela  
110 / 000 [1:32]

1.

38 GALANDI, Marlene  
000 s1 / 110 [2:51]

28 GALANDI, Marlene  
110 / 010 [2:47]

**Pool D - Winner**  
Vainqueur / Sieger

**Results**  
Résultat / Platzierungen

- POLLERES, Michaela AUT
- GALANDI, Marlene GER
- KUKA, Loriana KOS
- SCOCCIMARRO, Giovanna GER
- JAGER, Hilde NED
- MAEKELBURG, Sarah GER
- BOEHM, Alina GER
- PECOLER, Zala SLO

Repechage / Trostrunde

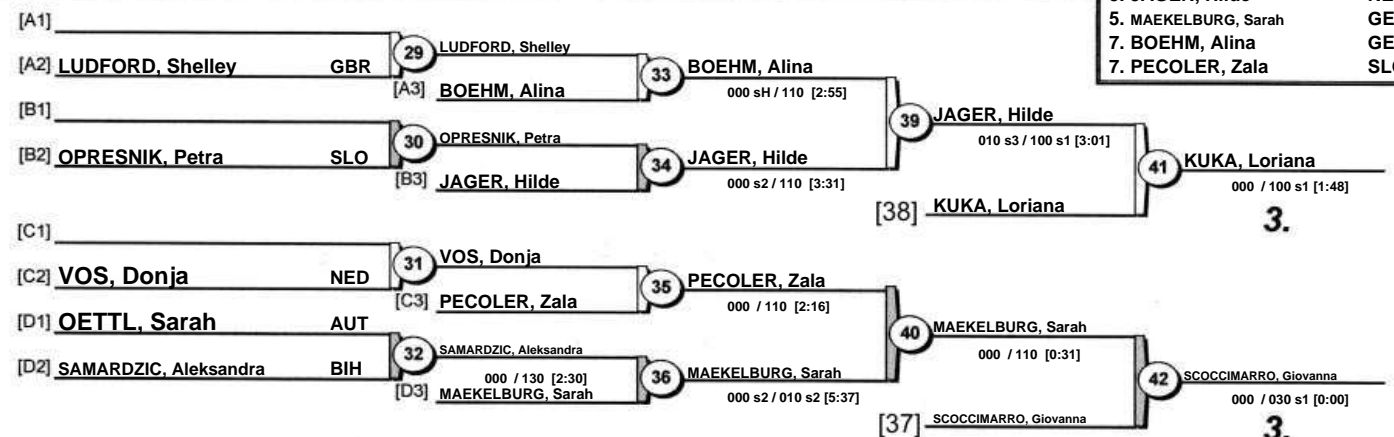



# Junior European Judo Cup Leibnitz 2017

(AUT Leibnitz, 3-4 June 2017)

## -78 kg

20 Judoka

POOL A

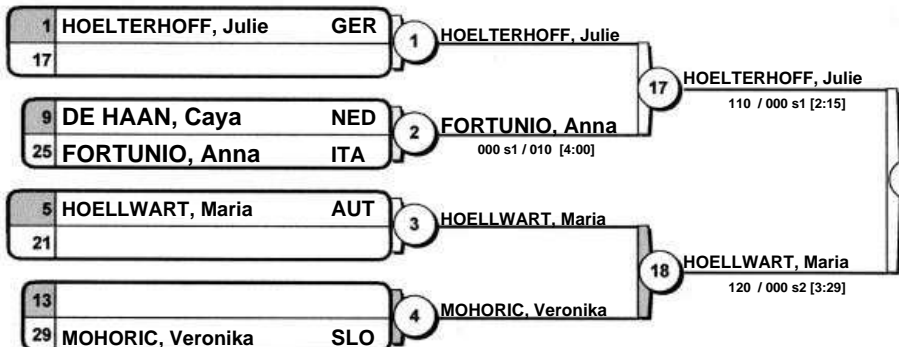

POOL B

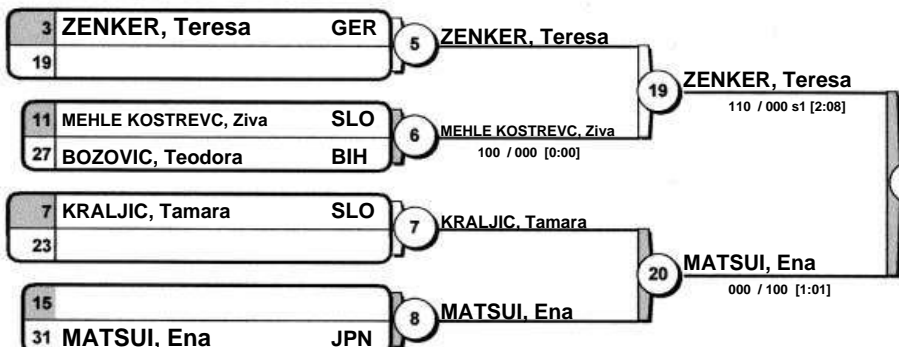

POOL C

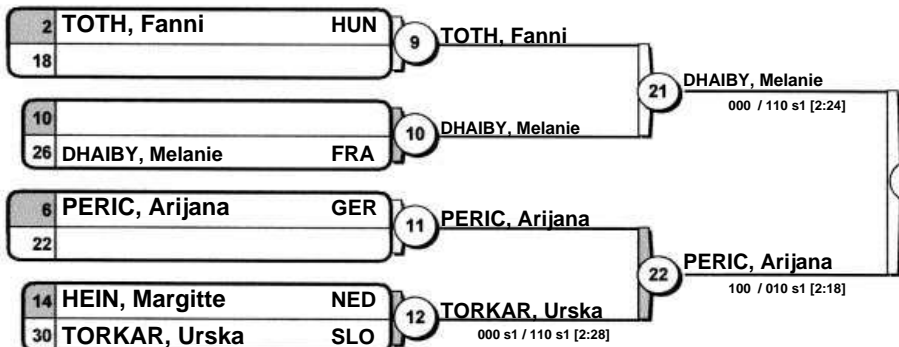

POOL D

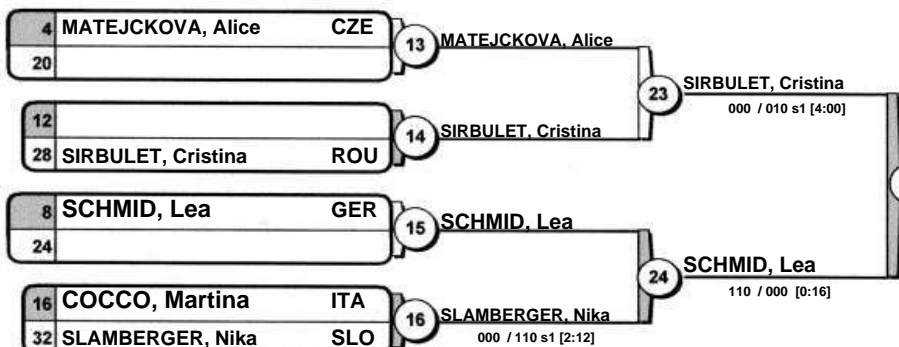

1.

### Results Résultat / Platzierungen

1. MATSUI, Ena JPN
2. SCHMID, Lea GER
3. DHAIBY, Melanie FRA
3. HOELTERHOFF, Julie GER
5. ZENKER, Teresa GER
5. PERIC, Arijana GER
7. FORTUNIO, Anna ITA
7. SLAMBERGER, Nika SLO

Repechage / Trostrunde

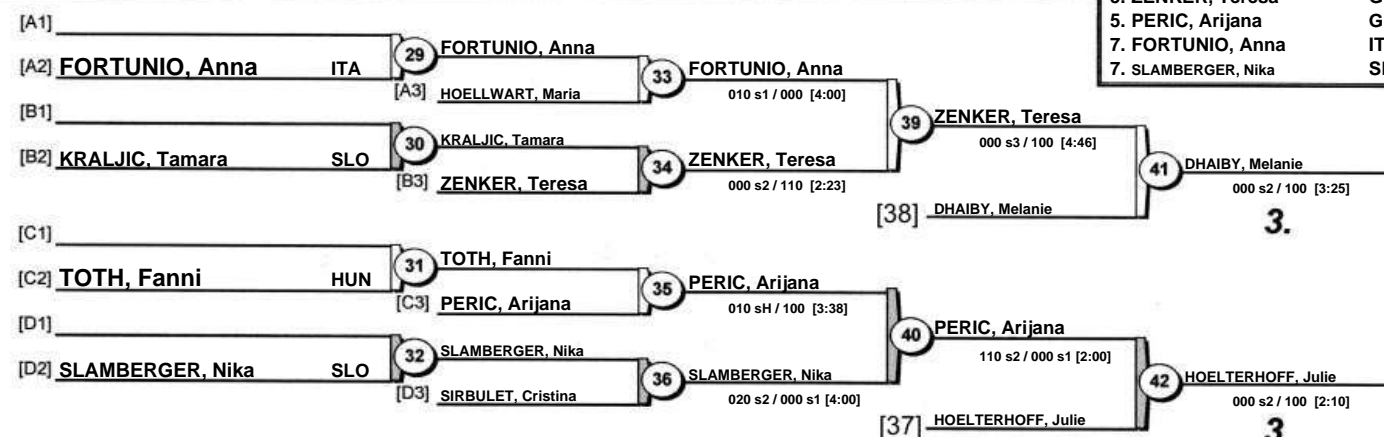

3.



# Junior European Judo Cup Leibnitz 2017

(AUT Leibnitz, 3-4 June 2017)

## +78 kg

17 Judoka

POOL A



POOL B

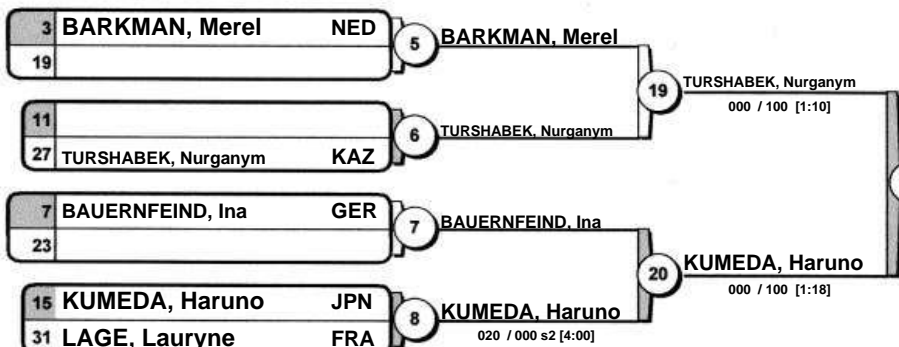

POOL C



POOL D



KUMEDA, Haruno

110 / 000 s1 [1:55]

1.

BOUIZGARNE, Samira

110 / 000 s2 [2:19]

### Results

Résultat / Platzierungen

- |    |                          |     |
|----|--------------------------|-----|
| 1. | KUMEDA, Haruno           | JPN |
| 2. | BOUIZGARNE, Samira       | GER |
| 3. | LAGE, Lauryne            | FRA |
| 3. | SZIGETVARI, Mercedesz    | HUN |
| 5. | BERLIKASH, Kamila        | KAZ |
| 7. | PIROGOVA, Sofiia         | RUS |
| 7. | MIOCIC, Zrinka           | CRO |
| 7. | VUKOVIC, Katarina Lucija | CRO |

Repechage / Trostrunde

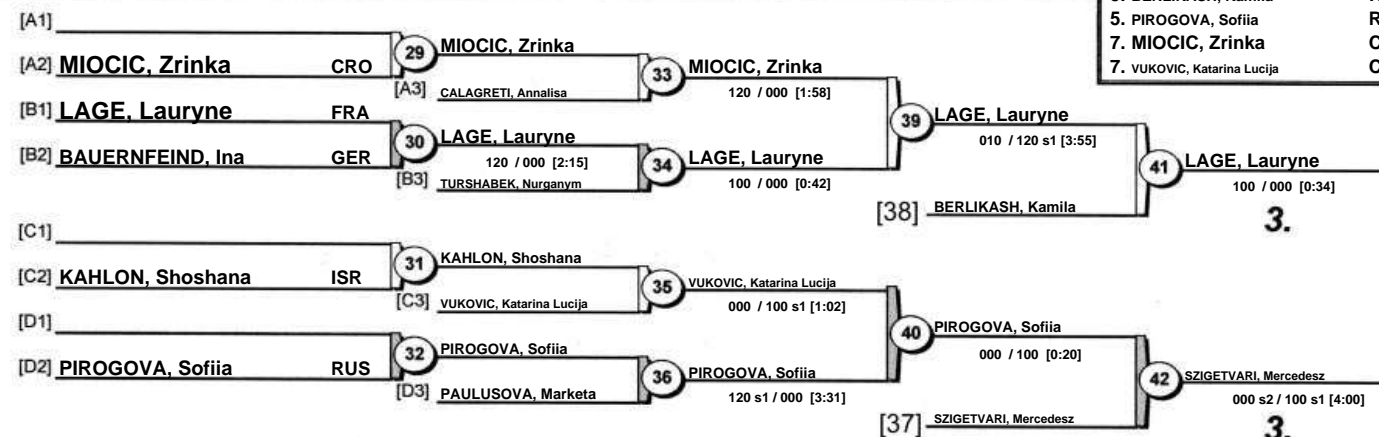

3.

3.