



POLAND OPEN

58th Tournament PYTLASINSKI

Tournament ZIOLKOWSKI

Warsaw 23-26.07.2015



FINAL REPORT

Complete results from the competition
available on: www.SportZona.pl

SPORTZONA.PL



XIX POLAND OPEN

FEMININE WRESTLING

WARSAW 24-26.07.2015



KLASYFIKACJA DRUŻYNOWA																			
Miejsce	Klub (Miejscowość)	Liczba zawodników	48		53		55		58		60		63		69		75		TOTAL
1	<u>POLAND (POL)</u>	21	14	/3	18	/2	8	/2	1	/6	1	/2	8	/1	9	/3	8	/2	67
2	<u>RUSSIA (RUS)</u>	16	10	/2	17	/4	0	/1	2	/2	6	/1	0	/2	3	/1	11	/3	49
3	<u>MONGOLIA (MGL)</u>	8	0	/1	6	/1	6	/1	10	/1	4	/1	0	/1	10	/1	6	/1	42
4-5	<u>AZERBAIJAN (AZE)</u>	6	10	/1	0	/1	6	/1	8	/1	8	/1	9	/1					41
4-5	<u>BELARUS (BLR)</u>	17	0	/4			13	/4			16	/3	10	/2	0	/2	2	/2	41
6	<u>UKRAINE (UKR)</u>	13	9	/3	0	/2	4	/1	0	/2	9	/1			8	/2	10	/2	40
7	<u>BULGARIA (BUL)</u>	6	8	/1			8	/1	4	/1	8	/1	6	/1	0	/1			34
8	<u>HUNGARY (HUN)</u>	6			4	/1			15	/2			1	/1	1	/1	0	/1	21
9	<u>TURKEY (TUR)</u>	8	1	/1	0	/1	0	/1	3	/1	2	/1	3	/1	0	/1	10	/1	19
10	<u>CANADA (CAN)</u>	6	3	/1	0	/1	0	/1			3	/1			8	/1	1	/1	15
11-12	<u>GERMANY (GER)</u>	4	0	/1	3	/1							2	/1	6	/1			11
11-12	<u>TUNISIA (TUN)</u>	1					10	/1											10
13	<u>ESTONIA (EST)</u>	1															9	/1	9
14-16	<u>CZECH REPUBLIC (CZE)</u>	2			0	/1							8	/1					8
14-16	<u>SPAIN (ESP)</u>	4	0	/1	8	/2			0	/1									8
14-16	<u>NORWAY (NOR)</u>	1							8	/1									8
17	<u>FRANCE (FRA)</u>	4	2	/1	1	/2									4	/1			7
18-20	<u>KYRGYZSTAN (KGZ)</u>	1							6	/1									6
18-20	<u>LATVIA (LAT)</u>	1											6	/1					6
18-20	<u>LITHUANIA (LTU)</u>	1													6	/1			6
21-22	<u>UNITED STATES (USA)</u>	1											4	/1					4
21-22	<u>EGYPT (EGY)</u>	4					2	/1	0	/1					2	/1	0	/1	4
23-26	<u>FINLAND (FIN)</u>	1			0	/1													0
23-26	<u>GREAT BRITAIN (GBR)</u>	1											0	/1					0
23-26	<u>SWEDEN (SWE)</u>	1							0	/1									0
23-26	<u>ITALY (ITA)</u>	1													0	/1			0
TOTAL:		136																	



XIX POLAND OPEN

FEMININE WRESTLING

WARSAW 24-26.07.2015



Klasyfikacja indywidualna kat: 48 kg

P	NAME & SURNAME	CLUB	YEAR	POINTS	TOUCH-FALL	SUPERIORITY:	points	LOST
1	Mariva Stadnik	AZERBAIJAN (AZE)	1988	21	1	4	50	0
2	Nataliya Pulkovska	UKRAINE (UKR)	1988	13	2	0	21	17
3	Elitsa Yankova	BULGARIA (BUL)	1994	12	0	0	23	17
3	Iwona Matkowska	POLAND (POL)	1982	14	0	2	32	17
5	Anna Lukasiak	POLAND (POL)	1988	7	0	1	18	12
5	V Chepsarakova	RUSSIA (RUS)	1984	6	0	0	15	14
7	Nadezhda Federova	RUSSIA (RUS)	1980	7	0	0	13	29
8	Genevieve Morrison	CANADA (CAN)	1980	4	0	1	10	4
9	Julia Sabatie	FRANCE (FRA)	1994	4	0	0	9	3
10	Sumeyva Sezer	TURKEY (TUR)	1990	3	0	0	8	17
11-12	N Erdenesukh	MONGOLIA (MGL)	1990	1	0	0	6	8
11-12	Garcia Eugenia Bustabad	SPAIN (ESP)	1990	1	0	0	6	8
13	Alina Ryzhova	BELARUS (BLR)	1980	1	0	0	6	16
14	Mariya Livach	UKRAINE (UKR)	1984	1	0	0	4	9
15-16	Tatsiana Yaframenka	BELARUS (BLR)	1996	1	0	0	1	4
15-16	Oleksandra Kogut	UKRAINE (UKR)	1987	1	0	0	1	4
17	Jaqueline Schellin	GERMANY (GER)	1990	1	0	0	1	7
18	Fatima Sidakova	BELARUS (BLR)	1996	0	0	0	0	8
19	Angelika Dytrych	POLAND (POL)	1993	0	0	0	0	10
20	Vivaleta Chyrvk	BELARUS (BLR)	1994	0	0	0	0	20

Klasyfikacja indywidualna kat: 53 kg

P	NAME & SURNAME	CLUB	YEAR	POINTS	TOUCH-FALL	SUPERIORITY:	points	LOST
1	Katarzyna Krawczyk	POLAND (POL)	1990	16	0	1	36	13
2	Liubov Silnikova	RUSSIA (RUS)		13	1	1	29	19
3	Roksana Zasina	POLAND (POL)	1988	12	1	0	18	11
3	Karima Sanchez Ramis	SPAIN (ESP)	1991	11	1	0	19	21
5	Sumiya Erdenechimeg	MONGOLIA (MGL)	1990	9	1	0	48	28
5	Irina Olqonova	RUSSIA (RUS)	1990	12	0	1	28	19
7	Mercedesz Denes	HUNGARY (HUN)	1994	8	0	0	14	17
8	Nina Hemmer	GERMANY (GER)	1984	6	1	0	14	19
9	Olga Khoroshavtseva	RUSSIA (RUS)	1994	5	1	0	8	6
10	Melanie Lesaffre	FRANCE (FRA)	1980	4	0	0	13	13
11	Anzhela Dorogan	AZERBAIJAN (AZE)	1990	1	0	0	7	8
12	Larysa Skoblyuk	UKRAINE (UKR)	1993	1	0	0	6	8
13	Brienne Barry	CANADA (CAN)	1986	1	0	0	3	5
14	Lenka Hockova	CZECH REPUBLIC (CZE)	1987	1	0	0	2	7
15	Mathide Rivere	FRANCE (FRA)	1989	1	0	0	2	10
16	Maria Gurova	RUSSIA (RUS)	1989	1	0	0	1	1
17	Tiina Ylinen	FINLAND (FIN)	1989	0	0	0	2	8
18	Yuliya Blahinva	UKRAINE (UKR)	1990	0	0	0	1	14
19	Fickive Gok	TURKEY (TUR)		0	0	0	0	4
20	Marina Rueda	SPAIN (ESP)	1986	0	0	0	0	20

Klasyfikacja indywidualna kat: 55 kg

P	NAME & SURNAME	CLUB	YEAR	POINTS	TOUCH-FALL	SUPERIORITY:	points	LOST
1	Marwa Amri	TUNISIA (TUN)	1980	17	2	1	28	2
2	Nadzeva Shushko	BELARUS (BLR)	1980	9	0	0	14	14
3	Paula Kozlow	POLAND (POL)	1994	12	0	0	13	6
3	Evelina Nikolova	BULGARIA (BUL)	1993	8	1	0	11	18
5	B. Sundev	MONGOLIA (MGL)	1990	9	1	0	18	16
5	Natalya Sinishin	AZERBAIJAN (AZE)	1985	9	0	2	22	4
7	Tetiana Kit	UKRAINE (UKR)	1984	6	1	0	5	8
8	Katsiaryna Hanchar	BELARUS (BLR)	1987	3	0	0	5	11
9	Fathi Habiba Tarek	EGYPT (EGY)		1	0	0	4	10
10	Uladlena Vvdrenko	BELARUS (BLR)	1994	1	0	0	2	8
11	Nade Dragunova	BELARUS (BLR)	1996	1	0	0	1	5
12	Veronika Chumikova	RUSSIA (RUS)		0	0	0	4	4
13	Jillian Gallays	CANADA (CAN)	1980	0	0	0	2	6
14	Bediha Gun	TURKEY (TUR)	1994	0	0	0	2	9
15	Paulina Nastarowicz	POLAND (POL)	1997	0	0	0	0	10



XIX POLAND OPEN

FEMININE WRESTLING

WARSAW 24-26.07.2015



Klasyfikacja indywidualna kat: 58 kg

P	NAME & SURNAME	CLUB	YEAR	POINTS	TOUCH-FALL	SUPERIORITY:	points	LOST
1	B. Shoovdor	MONGOLIA (MGL)	2000	17	2	1	17	2
2	Marianna Sastin	HUNGARY (HUN)	1983	16	1	2	42	16
3	Yuliya Ratkevich	AZERBAIJAN (AZE)	1985	17	2	1	31	15
3	Grace Bullen	NORWAY (NOR)	1995	12	0	3	30	2
5	Emese Barka	HUNGARY (HUN)	1990	13	1	1	24	15
5	Aisuluu Tynybekova	KYRGYZSTAN (KGZ)	1990	8	0	1	18	12
7	Mimi Hristova	BULGARIA (BUL)	1993	7	1	0	11	11
8	Cemile Unudan	TURKEY (TUR)	1995	5	1	0	0	10
9	Oksana Nagornvkh	RUSSIA (RUS)	1986	3	0	0	4	15
10	Natalia Kubaty	POLAND (POL)	1995	3	0	0	2	11
11	Katarzyna Michalak	POLAND (POL)	1993	3	0	0	2	12
13-gru	Iliulia Alborova	RUSSIA (RUS)		1	0	0	1	2
13-gru	Anna Zwiradowska	POLAND (POL)	1986	1	0	0	1	2
14	Irena Garcia	SPAIN (ESP)		1	0	0	1	4
15	Ganna Vasvlenko	UKRAINE (UKR)	1984	1	0	0	1	8
16	Paulina Grabowska	POLAND (POL)	1988	0	0	0	0	0
17	Eman Essam Gudia	EGYPT (EGY)		0	0	0	0	2
18	Aleksandra Wólczyńska	POLAND (POL)	1997	0	0	0	0	6
19	Johanna Mattsson	SWEDEN (SWE)	1988	0	0	0	0	7
20	Katarzyna Madrowska	POLAND (POL)	1995	0	0	0	0	10
21	Irina Husvak	UKRAINE (UKR)		0	0	0	0	23

Klasyfikacja indywidualna kat: 60 kg

P	NAME & SURNAME	CLUB	YEAR	POINTS	TOUCH-FALL	SUPERIORITY:	points	LOST
1	Anastasia Huchok	BELARUS (BLR)	1992	10	0	1	19	3
2	Oksana Herhel	UKRAINE (UKR)	1994	14	2	0	29	13
3	Dzhanan Manolova	BULGARIA (BUL)	1993	4	0	0	6	10
3	Irina Netteba	AZERBAIJAN (AZE)	1991	6	0	0	9	13
5	Anastasia Ivanova	BELARUS (BLR)	1980	6	1	0	2	12
5	Yulia Prontsevich	RUSSIA (RUS)	1980	8	0	1	30	27
7	T. Sukhee	MONGOLIA (MGL)	2000	6	0	1	19	10
8	Breanne Graham	CANADA (CAN)		3	0	0	8	12
9	Hafize Sahin	TURKEY (TUR)	1984	1	0	0	8	13
10	Agnieszka Król	POLAND (POL)	1994	1	0	0	2	8
11	Nikola Chluba	POLAND (POL)	1993	1	0	0	1	12
12	Veranica Ivanova	BELARUS (BLR)	1996	0	0	0	0	0

Klasyfikacja indywidualna kat: 63 kg

P	NAME & SURNAME	CLUB	YEAR	POINTS	TOUCH-FALL	SUPERIORITY:	points	LOST
1	Marvia Mamashuk	BELARUS (BLR)	1990	14	1	0	20	8
2	Nadiia Mushka	AZERBAIJAN (AZE)	1985	9	0	0	23	13
3	Monika Michalik	POLAND (POL)	1980	11	0	1	29	11
3	Adela Hanzlíková	CZECH REPUBLIC (CZE)	1994	16	2	0	16	23
5	Anastasia Griqorieva	LATVIA (LAT)	1990	5	0	0	18	18
5	Taybe Yusein	BULGARIA (BUL)	1991	4	0	0	16	12
7	Amanda Hendey	UNITED STATES (USA)		5	1	0	12	9
8	Buse Tosun	TURKEY (TUR)	1994	5	0	1	17	13
9	Nadine Weinange	GERMANY (GER)	1993	5	0	1	14	17
10	Gabriella Sleisz	HUNGARY (HUN)	1990	1	0	0	4	12
11	Battsetseg Soronzonbold	MONGOLIA (MGL)		0	0	0	11	10
12	Darima Sanzheeva	RUSSIA (RUS)	1980	0	0	0	5	8
13-14	Natalia Fedoseeva	RUSSIA (RUS)		0	0	0	0	10
13-14	Chloe Spiteri	GREAT BRITAIN (GBR)	1980	0	0	0	0	10
15	Madzina Sidakova	BELARUS (BLR)	1984	0	0	0	0	11

Klasyfikacja indywidualna kat: 69 kg

P	NAME & SURNAME	CLUB	YEAR	POINTS	TOUCH-FALL	SUPERIORITY:	points	LOST
1	Nasanburmaa Ochirbat	MONGOLIA (MGL)	1990	13	0	1	30	16
2	Agnieszka Wieszczak	POLAND (POL)	1983	11	0	1	26	8
3	Alina Makhynia	UKRAINE (UKR)		14	2	0	12	6
3	Dorothy Yeats	CANADA (CAN)	1986	13	1	1	36	12
5	Danute Domikaityte	LITHUANIA (LTU)	1995	6	1	0	4	18
5	Anna Schell	GERMANY (GER)		5	1	0	4	15
7	Cynthia Vescan	FRANCE (FRA)	1980	9	1	0	20	11
8	Anastasia Shchavlinskaja	RUSSIA (RUS)	1980	5	0	1	17	12
9	Nadia Anter	EGYPT (EGY)	1990	5	0	1	14	7
10	Vanessa Wilson	HUNGARY (HUN)	1986	4	0	1	11	10
11	Elina Vaseva	BULGARIA (BUL)	1986	4	0	0	9	16
12	Dalma Caneva	ITALY (ITA)	1994	1	0	0	4	5
13	Natalia Strzalka	POLAND (POL)	1997	1	0	0	2	12
14	Alicja Kubaty	POLAND (POL)	1995	0	0	0	0	2
15	Sinem Topcu	TURKEY (TUR)	1994	0	0	0	0	8
16-17	Katsiaryna Zubarevich	BELARUS (BLR)	1995	0	0	0	0	10
16-17	Liudmyla Tvchyna	UKRAINE (UKR)	1994	0	0	0	0	10
18	Krvstiana Fedarashka	BELARUS (BLR)	1994	0	0	0	0	11

Klasyfikacja indywidualna kat: 75 kg

P	NAME & SURNAME	CLUB	YEAR	POINTS	TOUCH-FALL	SUPERIORITY:	points	LOST
1	Yasemin Adar	TURKEY (TUR)	1991	16	1	2	48	21
2	Epp Mae	ESTONIA (EST)	1990	12	1	0	10	11
3	Alena Perepelkina	RUSSIA (RUS)	1990	12	1	0	13	4
3	Daria Osocka	POLAND (POL)	1992	11	0	2	32	10
5	Naranchimeg Gelegjamts	MONGOLIA (MGL)		5	0	0	10	23
5	Kateryna Sassa	UKRAINE (UKR)	1984	5	1	0	4	8
7	Alla Cherkasova	UKRAINE (UKR)	1980	7	1	0	20	21
8	Alena Starodubtseva	RUSSIA (RUS)	1985	6	1	0	7	7
9	Natalia Lanko	BELARUS (BLR)	1980	5	0	0	0	8
10	Justina Distasio	CANADA (CAN)	1986	1	0	0	1	3
11	Samar Amer	EGYPT (EGY)		0	0	0	2	5
12	Zsanett Nemeth	HUNGARY (HUN)	1994	0	0	0	2	6
13	Vasilisa Marzaliuk	BELARUS (BLR)	1987	0	0	0	0	0
14-15	Patrycja Howis	POLAND (POL)	1991	0	0	0	0	10
14-15	Alena Afanasjeva	RUSSIA (RUS)		0	0	0	0	12



Feuille de compétition / Competition Sheet

LVIII Memoriał Władysława Pytłasińskiego/Poland OPEN



Style: null

FW48

QUALIFICATION		1/8 FINALE	1/4 FINALE	1/2 FINALE	FINALE	WINNER
1	V Chepsarakova (RUS)	P1 P2	1 3 8 RUS P1 P2 2 6	1 3 4 RUS P1 P2 2 2	1 0 3 RUS P1 P2 0 3	
2	N Erdenesukh (MGL)	P1 P2	2 1 6 MGL P1 P2 3 3			
3	Genevieve Morrison (CAN)	P1 P2	3 4 10 CAN P1 P2 10 0	3 0 0 CAN P1 P2 0 0		
4	Angelika Dytrych (POL)	P1 P2	4 0 0 POL P1 P2 0 0			
5	Mariya Livach (UKR)	P1 P2	5 1 4 UKR P1 P2 4 0	6 1 4 BUL P1 P2 4 0	7 5 8 UKR P1 P2 2 6	
6	Elitsa Yankova (BUL)	P1 P2	6 3 9 BUL P1 P2 1 8			
7	Nataliya Pulkovska (UKR)	P1 P2	7 5 6 UKR P1 P2 6 0	7 3 7 UKR P1 P2 5 2		
8	Alina Ryzhova (BLR)	P1 P2	8 0 0 BLR P1 P2 0 0			
9	Sumeyya Sezer (TUR)	P1 P2	9 3 8 TUR P1 P2 4 4	9 0 0 TUR P1 P2 0 0		20 Mariya Stadnik (AZE)
10	Garcia Eugenia Bustabad (ESP)	P1 P2	10 1 6 ESP P1 P2 2 4			
11	Jaqueline Schellin (GER)	P1 P2	11 1 1 GER P1 P2 1 0	12 4 11 POL P1 P2 5 6		
12	Anna Łukasiak (POL)	P1 P2	12 3 7 POL P1 P2 2 5			
13	Julie Sabatie (FRA)	P1 P2	13 1 1 FRA P1 P2 0 1	16 0 0 RUS P1 P2 0 0		
14	Fatima Sidakova (BLR)	P1 P2	0 0 0			
15	Tatsiana Yaframenka (BLR)	P1 P2	1 1 0	16 3 3 RUS P1 P2 3 0		
16	Nadezhda Federova (RUS)	P1 P2	3 4 2 2			
17	Iwona Matkowska (POL)	P1 P2	3 4 0 4	17 0 0 POL P1 P2 0 0	20 4 10 AZE P1 P2 10 0	
18	Oleksandra Kogut (UKR)	P1 P2	1 1 0			
19	Viyaleta Chyryk (BLR)	P1 P2	0 0 0	20 5 10 AZE P1 P2 10 0		
20	Mariya Stadnik (AZE)	P1 P2	4 10 10 0			



Feuille de compétition / Competition Sheet
LVIII Memoriał Władysława Pytłasińskiego/Poland OPEN



Style: null

FW48

"REPECHAGE"
"UPPER BRANCH"

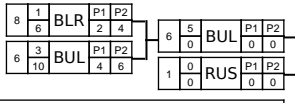

Médaille de Bronze 6 Elitsa Yankova (BUL)

"LOWER BRANCH"

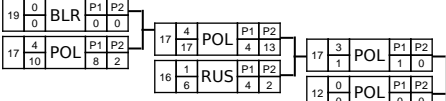

Médaille de Bronze 17 Iwona Matkowska (POL)

Classement

Cl	Pays	Nom
1	AZE	Mariya Stadnik (AZE)
2	UKR	Nataliya Pulkovska (UKR)
3	BUL	Elitsa Yankova (BUL)
3	POL	Iwona Matkowska (POL)
5	POL	Anna Łukasiak (POL)
5	RUS	V Chepsarakova (RUS)
7	RUS	Nadezhda Federova (RUS)
8	CAN	Genevieve Morrison (CAN)
9	FRA	Julie Sabatie (FRA)
10	TUR	Sumeyya Sezer (TUR)
11-12	MGL	N Erdenesukh (MGL)
11-12	ESP	Garcia Eugenia Bustabad (ESP)
13	BLR	Alina Ryzhova (BLR)
14	UKR	Mariya Livach (UKR)
15-16	BLR	Tatsiana Yaframenka (BLR)
15-16	UKR	Oleksandra Kogut (UKR)
17	GER	Jaqueline Schellin (GER)
18	BLR	Fatima Sidakova (BLR)
19	POL	Angelika Dytrych (POL)
20	BLR	Viyaleta Chyryk (BLR)



Feuille de compétition / Competition Sheet

LVIII Memoriał Władysława Pytłasińskiego/Poland OPEN



Style: null FW53

QUALIFICATION		1/8 FINALE	1/4 FINALE	1/2 FINALE	FINALE	WINNER
1	Nina Hemmer (GER)	P1 P2	1 5/4 GER P1 P2 4 0	1 1/10 GER P1 P2 4 6		
2	Fickiye Gok (TUR)	P1 P2	2 0/0 TUR P1 P2 0 0			
3	Yuliya Blahinya (UKR)	P1 P2	3 0/1 UKR P1 P2 1 0			
4	Sumiya Erdenechimeg (MGL)	P1 P2	4 5/14 MGL P1 P2 8 6	4 3/19 MGL P1 P2 5 14	4 0/10 MGL P1 P2 6 4	
5	Karima Sanchez Ramis (ESP)	P1 P2	5 3/8 ESP P1 P2 4 4	5 0/0 ESP P1 P2 0 0		
6	Larysa Skoblyuk (UKR)	P1 P2	6 1/8 UKR P1 P2 2 4			
7	Lenka Hockova (CZE)	P1 P2	7 1/2 CZE P1 P2 2 0			
8	Liubov Silnikova (RUS)	P1 P2	8 3/4 RUS P1 P2 2 2	8 4/10 RUS P1 P2 8 2	8 5/9 RUS P1 P2 1 8	
9	Maria Gurova (RUS)	P1 P2	9 1/1 RUS P1 P2 1 0			
10	Roksana Zasina (POL)	P1 P2	10 3/1 POL P1 P2 0 1	10 5/4 POL P1 P2 4 0		
11	Olga Khoroshavtseva (RUS)	P1 P2	11 5/8 RUS P1 P2 8 0	11 0/0 RUS P1 P2 0 0		
12	Tiina Ylinen (FIN)	P1 P2	12 0/2 FIN P1 P2 2 0			
13	Brianne Barry (CAN)	P1 P2	14 3/6 HUN P1 P2 4 2			
14	Mercedesz Denes (HUN)	P1 P2	14 1/4 HUN P1 P2 2 0			
15	Anzhela Dorogan (AZE)	P1 P2	16 1/5 FRA P1 P2 2 3			
16	Melanie Lesaffre (FRA)	P1 P2	18 3/8 POL P1 P2 8 0			
17	Marina Rueda (ESP)	P1 P2	18 3/5 POL P1 P2 2 3			
18	Katarzyna Krawczyk (POL)	P1 P2	18 3/6 POL P1 P2 6 0			
19	Mathide Rivere (FRA)	P1 P2	20 1/3 RUS P1 P2 1 2			
20	Irina Olgonova (RUS)	P1 P2				
						18 Katarzyna Krawczyk (POL)

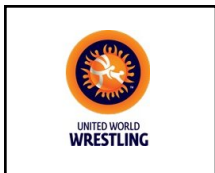

Feuille de compétition / Competition Sheet

LVIII Memoriał Władysława Pytlasińskiego/Poland OPEN



Style: null

FW53

"REPECHAGE"

"UPPER BRANCH"

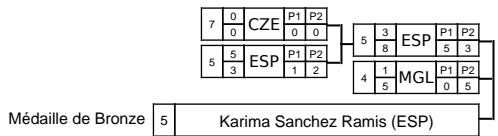

"LOWER BRANCH"

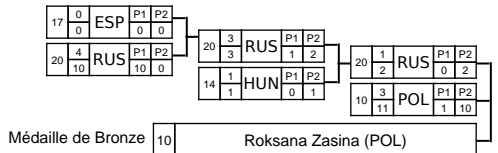

Classement		
Cl	Pays	Nom
1	POL	Katarzyna Krawczyk (POL)
2	RUS	Liubov Silnikova (RUS)
3	POL	Roksana Zasina (POL)
3	ESP	Karima Sanchez Ramis (ESP)
5	MGL	Sumiya Erdenechimeg (MGL)
5	RUS	Irina Olgonova (RUS)
7	HUN	Mercedesz Denes (HUN)
8	GER	Nina Hemmer (GER)
9	RUS	Olga Khoroshavtseva (RUS)
10	FRA	Melanie Lesaffre (FRA)
11	AZE	Anzhela Dorogan (AZE)
12	UKR	Larysa Skoblyuk (UKR)
13	CAN	Brianne Barry (CAN)
14	CZE	Lenka Hockova (CZE)
15	FRA	Mathide Rivere (FRA)
16	RUS	Maria Gurova (RUS)
17	FIN	Tiina Ylinen (FIN)
18	UKR	Yuliya Blahinya (UKR)
19	TUR	Fickiye Gok (TUR)
20	ESP	Marina Rueda (ESP)



Feuille de compétition / Competition Sheet

LVIII Memoriał Władysława Pytłasińskiego/Poland OPEN



Style: null

FW55

QUALIFICATION	1/4 FINALE	1/2 FINALE	FINALE	WINNER
---------------	------------	------------	--------	--------



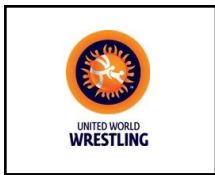

Feuille de compétition / Competition Sheet
LVIII Memoriał Władysława Pytlasińskiego/Poland OPEN



Style: null

FW55

"REPECHAGE"
"UPPER BRANCH"

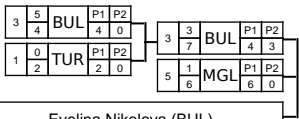

Médaille de Bronze 3 Evelina Nikolova (BUL)

"LOWER BRANCH"

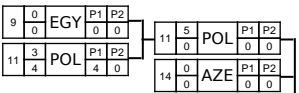

Médaille de Bronze 11 Paula Kozow (POL)

Classement		
Cl	Pays	Nom
1	TUN	Marwa Amri (TUN)
2	BLR	Nadzeya Shushko (BLR)
3	BUL	Evelina Nikolova (BUL)
3	POL	Paula Kozłow (POL)
5	MGL	B. Sundev (MGL)
5	AZE	Natalya Sinishin (AZE)
7	UKR	Tetiana Kit (UKR)
8	BLR	Katsiaryna Hanchar (BLR)
9	EGY	Fathi Habiba Tarek (EGY)
10	BLR	Uladlena Vydrenko (BLR)
11	BLR	Nade Dragunova (BLR)
12	RUS	Veronika Chumikova (RUS)
13	CAN	Jillian Gallays (CAN)
14	TUR	Bediha Gün (TUR)
15	POL	Paulina Nastarowicz (POL)



Feuille de compétition / Competition Sheet

LVIII Memoriał Władysława Pytłasińskiego/Poland OPEN



Style: null

FW58

QUALIFICATION		1/8 FINALE	1/4 FINALE	1/2 FINALE	FINALE	WINNER
1	Anna Zwirydowska (POL)	P1 P2	1 1 POL P1 P2 0 1	2 0 POL P1 P2 0 0	3 0 NOR P1 P2 0 0	5 B. Shoovdor (MGL)
2	Natalia Kubaty (POL)	P1 P2	2 3 POL P1 P2 2 1 1	3 4 NOR P1 P2 10 0	5 5 MGL P1 P2 0 0	
3	Grace Bullen (NOR)	P1 P2	3 4 NOR P1 P2 10 0	3 4 NOR P1 P2 10 2 8	5 5 MGL P1 P2 0 0	
4	Katarzyna Mądrowska (POL)	P1 P2	4 0 POL P1 P2 0 0	5 3 MGL P1 P2 2 0	5 5 MGL P1 P2 2 0	
5	B. Shoovdor (MGL)	P1 P2	5 4 MGL P1 P2 13 9 4	5 3 MGL P1 P2 2 0	5 5 MGL P1 P2 2 0	
6	Irina Husyak (UKR)	P1 P2	6 0 UKR P1 P2 0 0	5 5 MGL P1 P2 2 0	5 5 MGL P1 P2 2 0	
7	Aleksandra Wólczyńska (POL)	P1 P2	7 0 POL P1 P2 0 0	8 1 KGZ P1 P2 2 0 2	5 5 MGL P1 P2 2 0	
8	Aisuluu Tynybekova (KGZ)	P1 P2	8 3 KGZ P1 P2 6 4 2	8 1 KGZ P1 P2 2 0 2	5 5 MGL P1 P2 2 0	
9	Iuliia Alborova (RUS)	P1 P2	9 1 RUS P1 P2 1 0	8 1 KGZ P1 P2 2 0 2	5 5 MGL P1 P2 2 0	
10	Katarzyna Michalak (POL)	P1 P2	10 0 POL P1 P2 0 0	8 1 KGZ P1 P2 2 0 2	5 5 MGL P1 P2 2 0	
11	Eman Essam Gudia (EGY)	P1 P2	11 0 EGY P1 P2 0 0	10 0 POL P1 P2 0 0	5 5 MGL P1 P2 2 0	
12	Ganna Vasylenko (UKR)	P1 P2	12 1 HUN P1 P2 1 2 0	10 0 POL P1 P2 0 0	5 5 MGL P1 P2 2 0	
13	Emese Barka (HUN)	P1 P2	13 5 HUN P1 P2 2 0	10 0 POL P1 P2 0 0	5 5 MGL P1 P2 2 0	
14	Cemile Unudan (TUR)	P1 P2	14 0 TUR P1 P2 0 0	13 1 HUN P1 P2 3 0	5 5 MGL P1 P2 2 0	
15	Paulina Grabowska (POL)	P1 P2	15 0 AZE P1 P2 0 0	13 1 HUN P1 P2 3 0	5 5 MGL P1 P2 2 0	
16	Johanna Mattsson (SWE)	P1 P2	16 4 AZE P1 P2 0 10 0	13 1 HUN P1 P2 3 0	5 5 MGL P1 P2 2 0	
17	Yuliya Ratkevich (AZE)	P1 P2	17 4 AZE P1 P2 10 10 0	13 1 HUN P1 P2 3 0	5 5 MGL P1 P2 2 0	
18	Irena Garcia (ESP)	P1 P2	18 0 RUS P1 P2 0 0 0	13 1 HUN P1 P2 3 0	5 5 MGL P1 P2 2 0	
19	Oksana Nagomykh (RUS)	P1 P2	19 0 RUS P1 P2 0 0 0	13 1 HUN P1 P2 3 0	5 5 MGL P1 P2 2 0	
20	Mimi Hristova (BUL)	P1 P2	20 4 HUN P1 P2 2 2 6 4	13 1 HUN P1 P2 3 0	5 5 MGL P1 P2 2 0	
21	Marianna Sastin (HUN)	P1 P2	21 4 HUN P1 P2 10 6 4	13 1 HUN P1 P2 3 0	5 5 MGL P1 P2 2 0	

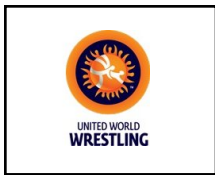

Feuille de compétition / Competition Sheet

LVIII Memoriał Władysława Pytłasińskiego/Poland OPEN



Style: null

FW58

"REPECHAGE"

"UPPER BRANCH"

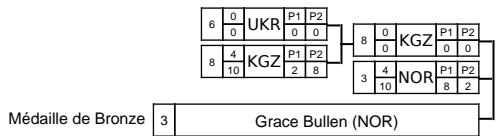

"LOWER BRANCH"

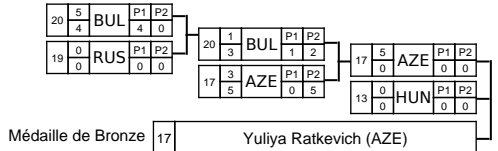

Classement		
Cl	Pays	Nom
1	MGL	B. Shoovdor (MGL)
2	HUN	Marianna Sastin (HUN)
3	AZE	Yuliya Ratkevich (AZE)
3	NOR	Grace Bullen (NOR)
5	HUN	Emese Barka (HUN)
5	KGZ	Aisuluu Tynybekova (KGZ)
7	BUL	Mimi Hristova (BUL)
8	TUR	Cemile Unudan (TUR)
9	RUS	Oksana Nagornykh (RUS)
10	POL	Natalia Kubaty (POL)
11	POL	Katarzyna Michalak (POL)
12-13	POL	Anna Zwirydowska (POL)
12-13	RUS	Iiulia Alborova (RUS)
14	ESP	Irena García (ESP)
15	UKR	Ganna Vasylenko (UKR)
16	POL	Paulina Grabowska (POL)
17	EGY	Eman Essam Gudia (EGY)
18	POL	Aleksandra Wólczyńska (POL)
19	SWE	Johanna Mattsson (SWE)
20	POL	Katarzyna Mądrowska (POL)
21	UKR	Irina Husyak (UKR)

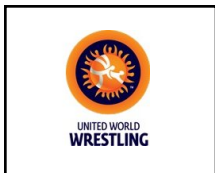

Feuille de compétition / Competition Sheet

LVIII Memoriał Władysława Pytłasińskiego/Poland OPEN



Style: null

FW60

"REPECHAGE"
"UPPER BRANCH"

4	3	BUL	P1	P2
	4		4	0
2	1	BLR	P1	P2
	2		0	2

Médaille de Bronze 4 Dzhanan Manolova (BUL)

"LOWER BRANCH"

6	3	AZE	P1	P2
	2		1	1
8	1	MGL	P1	P2
	1		0	1
6	3	AZE	P1	P2
	7		0	7
11	1	RUS	P1	P2
	3		3	0

Médaille de Bronze 6 Irina Netreba (AZE)

Classement		
Cl	Pays	Nom
1	BLR	Anastasia Huchok (BLR)
2	UKR	Oksana Herhel (UKR)
3	BUL	Dzhanan Manolova (BUL)
3	AZE	Irina Netreba (AZE)
5	BLR	Anastasia Ivanova (BLR)
5	RUS	Yulia Prontsevich (RUS)
7	MGL	T. Sukhee (MGL)
8	CAN	Breanne Graham (CAN)
9	TUR	Hafize Sahin (TUR)
10	POL	Agnieszka Król (POL)
11	POL	Nikoła Chłuba (POL)
12	BLR	Veranica Ivanova (BLR)

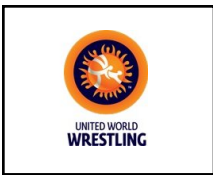

Feuille de compétition / Competition Sheet

LVIII Memoriał Władysława Pytłasińskiego/Poland OPEN



Style: null

FW63

QUALIFICATION	1/4 FINALE	1/2 FINALE	FINALE	WINNER
---------------	------------	------------	--------	--------





Feuille de compétition / Competition Sheet
LVIII Memoriał Władysława Pytlasińskiego/Poland OPEN



Style: null

FW63

"REPECHAGE"
"UPPER BRANCH"

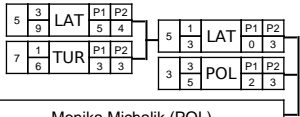

Médaille de Bronze 3 Monika Michalik (POL)

"LOWER BRANCH"

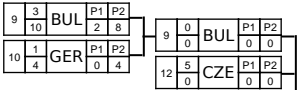

Médaille de Bronze 12 Adela Hanzlikova (CZE)

Classement		
Cl	Pays	Nom
1	BLR	Maryia Mamashuk (BLR)
2	AZE	Nadiia Mushka (AZE)
3	POL	Monika Michalik (POL)
3	CZE	Adela Hanzlíčkova (CZE)
5	LAT	Anastasija Grigorjeva (LAT)
5	BUL	Taybe Yusein (BUL)
7	USA	Amanda Hendey (USA)
8	TUR	Buse Tosun (TUR)
9	GER	Nadine Weinange (GER)
10	HUN	Gabriella Sleisz (HUN)
11	MGL	Battsetseg Soronzonbold (MGL)
12	RUS	Darima Sanzheeva (RUS)
13-14	RUS	Natalia Fedoseeva (RUS)
13-14	GBR	Chloe Spiteri (GBR)
15	BLR	Madzina Sidakova (BLR)



Feuille de compétition / Competition Sheet

LVIII Memoriał Władysława Pytłasińskiego/Poland OPEN



Style: null

FW69

QUALIFICATION		1/8 FINALE	1/4 FINALE	1/2 FINALE	FINALE	WINNER
1	Dalma Caneva (ITA)	1 1 4	1 1 3	2 1 1	4 3 2	13 Nasanburmaa Ochirbat (MGL)
2	Elina Vaseva (BUL)	2 3 5	2 4 1	2 1 0	4 3 2	
3	Anna Schell (GER)	3 0 0	3 0 0	4 3 8	4 1 6	
4	Agnieszka Wieszczyk-Kordus	4 4 10	4 4 6	4 3 8	4 1 6	
5	Katsiaryna Zubarevich (BLR)	5 0 0	5 0 0	6 1 4	8 1 1	
6	Nadia Anter (EGY)	6 4 10	6 10 0	6 1 4	8 1 1	
7	Alicja Kubaty (POL)	7 0 0	7 0 0	8 3 7	12 1 8	
8	Alina Makhynia (UKR)	8 5 2	8 2 0	8 3 7	12 1 8	
9	Krystiana Fedarashka (BLR)	9 0 0	9 0 0	10 0 0	12 4 10	
10	Vanessa Wilson (HUN)	10 4 11	10 1 10	10 0 0	12 4 10	
11	Liudmyla Tychyna (UKR)	11 0 0	11 0 0	12 4 10	12 4 10	
12	Dorothy Yeats (CAN)	12 5 10	12 10 0	12 4 10	12 4 10	
13	Nasanburmaa Ochirbat (MGL)	13 4 10	13 10 0	13 3 6	13 3 6	
14	Danute Domikaityte (LTU)	14 0 0	14 0 0	13 3 6	13 3 6	
15	Cynthia Vescan (FRA)	15 3 8	15 4 6	15 1 2	15 1 2	
16	Sinem Topcu (TUR)	16 0 0	16 0 0	15 1 2	15 1 2	
17	Anastasia Shchavilnskaia (RUS)	17 4 12	17 2 10	17 1 5	17 1 5	
18	Natalia Strzałka (POL)	18 1 2	18 0 2	17 1 5	17 1 5	

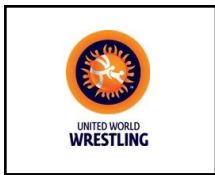

Feuille de compétition / Competition Sheet
LVIII Memoriał Władysława Pytłasińskiego/Poland OPEN



Style: null

FW69

"REPECHAGE"
"UPPER BRANCH"

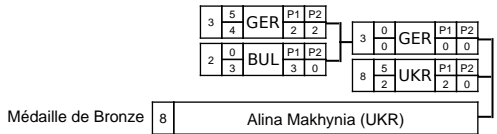

"LOWER BRANCH"

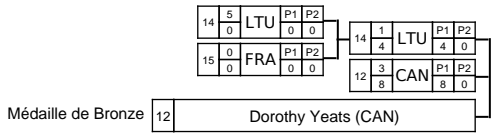

Classement		
Cl	Pays	Nom
1	MGL	Nasanburmaa Ochirbat (MGL)
2	POL	Agnieszka Wieszczyk-Kordus (POL)
3	CAN	Dorothy Yeats (CAN)
3	UKR	Alina Makhynia (UKR)
5	GER	Anna Schell (GER)
5	LTU	Danute Domikaityte (LTU)
7	FRA	Cynthia Vescan (FRA)
8	RUS	Anastasia Shchavilinskaia (RUS)
9	EGY	Nadia Anter (EGY)
10	HUN	Vanessa Wilson (HUN)
11	BUL	Elina Vaseva (BUL)
12	ITA	Dalma Caneva (ITA)
13	POL	Natalia Strzałka (POL)
14	POL	Alicja Kubaty (POL)
15	TUR	Sinem Topcu (TUR)
16-17	UKR	Liudmyla Tychyna (UKR)
16-17	BLR	Katsiaryna Zubarevich (BLR)
18	BLR	Krystiana Fedarashka (BLR)



Feuille de compétition / Competition Sheet
LVIII Memoriał Władysława Pytlasińskiego/Poland OPEN



Style: null FW75

QUALIFICATION		1/4 FINALE	1/2 FINALE	FINALE	WINNER														
1	<table border="1"><tr><td></td><td></td></tr><tr><td></td><td></td></tr></table> Patrycja Howis (POL)					<table border="1"><tr><td>1</td><td>0</td><td>0</td><td>P1</td><td>P2</td></tr><tr><td></td><td></td><td></td><td>0</td><td>0</td></tr></table>	1	0	0	P1	P2				0	0			
1	0	0	P1	P2															
			0	0															
	<table border="1"><tr><td></td><td></td></tr><tr><td></td><td></td></tr></table>																		
2	<table border="1"><tr><td>4</td><td></td></tr><tr><td>12</td><td></td></tr></table> Daria Osocka (POL)	4		12		<table border="1"><tr><td>2</td><td>4</td><td>10</td><td>P1</td><td>P2</td></tr><tr><td></td><td></td><td></td><td>10</td><td>0</td></tr></table>	2	4	10	P1	P2				10	0			
4																			
12																			
2	4	10	P1	P2															
			10	0															
	<table border="1"><tr><td></td><td></td></tr><tr><td></td><td></td></tr></table>																		
3	<table border="1"><tr><td>0</td><td></td></tr><tr><td>0</td><td></td></tr></table> Alena Afanasyeva (RUS)	0		0															
0																			
0																			
	<table border="1"><tr><td></td><td></td></tr><tr><td></td><td></td></tr></table>																		
4	<table border="1"><tr><td>0</td><td></td></tr><tr><td>2</td><td></td></tr></table> Zsanett Nemeth (HUN)	0		2		<table border="1"><tr><td>5</td><td>1</td><td>11</td><td>P1</td><td>P2</td></tr><tr><td></td><td></td><td></td><td>4</td><td>7</td></tr></table>	5	1	11	P1	P2				4	7			
0																			
2																			
5	1	11	P1	P2															
			4	7															
	<table border="1"><tr><td></td><td></td></tr><tr><td></td><td></td></tr></table>																		
5	<table border="1"><tr><td>5</td><td></td></tr><tr><td>6</td><td></td></tr></table> Alla Cherkasova (UKR)	5		6															
5																			
6																			
	<table border="1"><tr><td></td><td></td></tr><tr><td></td><td></td></tr></table>																		
6	<table border="1"><tr><td>1</td><td></td></tr><tr><td>4</td><td></td></tr></table> Naranchimeg Gelegjamts	1		4		<table border="1"><tr><td>7</td><td>3</td><td>15</td><td>P1</td><td>P2</td></tr><tr><td></td><td></td><td></td><td>8</td><td>7</td></tr></table>	7	3	15	P1	P2				8	7			
1																			
4																			
7	3	15	P1	P2															
			8	7															
	<table border="1"><tr><td></td><td></td></tr><tr><td></td><td></td></tr></table>																		
7	<table border="1"><tr><td>4</td><td></td></tr><tr><td>15</td><td></td></tr></table> Yasemin Adar (TUR)	4		15															
4																			
15																			
	<table border="1"><tr><td></td><td></td></tr><tr><td></td><td></td></tr></table>																		
8	<table border="1"><tr><td>1</td><td></td></tr><tr><td>1</td><td></td></tr></table> Justina Distasio (CAN)	1		1		<table border="1"><tr><td>9</td><td>3</td><td>5</td><td>P1</td><td>P2</td></tr><tr><td></td><td></td><td></td><td>1</td><td>4</td></tr></table>	9	3	5	P1	P2				1	4			
1																			
1																			
9	3	5	P1	P2															
			1	4															
	<table border="1"><tr><td></td><td></td></tr><tr><td></td><td></td></tr></table>																		
9	<table border="1"><tr><td>3</td><td></td></tr><tr><td>3</td><td></td></tr></table> Alena Perepelkina (RUS)	3		3		<table border="1"><tr><td>9</td><td>1</td><td>1</td><td>P1</td><td>P2</td></tr><tr><td></td><td></td><td></td><td>1</td><td>0</td></tr></table>	9	1	1	P1	P2				1	0			
3																			
3																			
9	1	1	P1	P2															
			1	0															
	<table border="1"><tr><td></td><td></td></tr><tr><td></td><td></td></tr></table>																		
10	<table border="1"><tr><td>5</td><td></td></tr><tr><td>5</td><td></td></tr></table> Alena Starodubtseva (RUS)	5		5		<table border="1"><tr><td>10</td><td>1</td><td>2</td><td>P1</td><td>P2</td></tr><tr><td></td><td></td><td></td><td>2</td><td>0</td></tr></table>	10	1	2	P1	P2				2	0			
5																			
5																			
10	1	2	P1	P2															
			2	0															
	<table border="1"><tr><td></td><td></td></tr><tr><td></td><td></td></tr></table>																		
11	<table border="1"><tr><td>0</td><td></td></tr><tr><td>2</td><td></td></tr></table> Samar Amer (EGY)	0		2															
0																			
2																			
	<table border="1"><tr><td></td><td></td></tr><tr><td></td><td></td></tr></table>																		
12	<table border="1"><tr><td>3</td><td></td></tr><tr><td>4</td><td></td></tr></table> Epp Mae (EST)	3		4		<table border="1"><tr><td>12</td><td>5</td><td>4</td><td>P1</td><td>P2</td></tr><tr><td></td><td></td><td></td><td>4</td><td>0</td></tr></table>	12	5	4	P1	P2				4	0			
3																			
4																			
12	5	4	P1	P2															
			4	0															
	<table border="1"><tr><td></td><td></td></tr><tr><td></td><td></td></tr></table>																		
13	<table border="1"><tr><td>0</td><td></td></tr><tr><td>0</td><td></td></tr></table> Kateryna Sassa (UKR)	0		0															
0																			
0																			
	<table border="1"><tr><td></td><td></td></tr><tr><td></td><td></td></tr></table>																		
14	<table border="1"><tr><td>5</td><td></td></tr><tr><td>0</td><td></td></tr></table> Natallia Lanko (BLR)	5		0		<table border="1"><tr><td>12</td><td>3</td><td>1</td><td>P1</td><td>P2</td></tr><tr><td></td><td></td><td></td><td>0</td><td>1</td></tr></table>	12	3	1	P1	P2				0	1			
5																			
0																			
12	3	1	P1	P2															
			0	1															
	<table border="1"><tr><td></td><td></td></tr><tr><td></td><td></td></tr></table>																		
15	<table border="1"><tr><td>0</td><td></td></tr><tr><td>0</td><td></td></tr></table> Vasilisa Marzaliuk (BLR)	0		0															
0																			
0																			
	<table border="1"><tr><td></td><td></td></tr><tr><td></td><td></td></tr></table>																		
				<table border="1"><tr><td>7</td><td>4</td><td>10</td><td>P1</td><td>P2</td></tr><tr><td></td><td></td><td></td><td>4</td><td>6</td></tr></table>	7	4	10	P1	P2				4	6					
7	4	10	P1	P2															
			4	6															
					<table border="1"><tr><td>7</td></tr></table> Yasemin Adar (TUR)	7													
7																			
				<table border="1"><tr><td>12</td><td>1</td><td>1</td><td>P1</td><td>P2</td></tr><tr><td></td><td></td><td></td><td>1</td><td>0</td></tr></table>	12	1	1	P1	P2				1	0					
12	1	1	P1	P2															
			1	0															

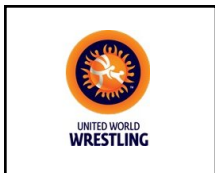

Feuille de compétition / Competition Sheet

LVIII Memoriał Władysława Pytłasińskiego/Poland OPEN



Style: null

FW75

"REPECHAGE"

"UPPER BRANCH"

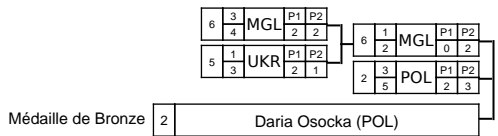

"LOWER BRANCH"

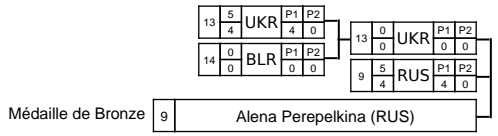

Classement		
Cl	Pays	Nom
1	TUR	Yasemin Adar (TUR)
2	EST	Epp Mae (EST)
3	RUS	Alena Perepelkina (RUS)
3	POL	Daria Osocka (POL)
5	UKR	Kateryna Sassa (UKR)
5	MGL	Naranchimeg Gelegjamts (MGL)
7	UKR	Alla Cherkasova (UKR)
8	RUS	Alena Starodubtseva (RUS)
9	BLR	Natallia Lanko (BLR)
10	CAN	Justina Distasio (CAN)
11	EGY	Samar Amer (EGY)
12	HUN	Zsanett Nemeth (HUN)
13	BLR	Vasilisa Marzaliuk (BLR)
14	POL	Patrycja Howis (POL)
15	RUS	Alena Afanasyeva (RUS)



LVIII MMORIAŁ WŁADYSŁAWA PYTLASIŃSKIEGO



GRECO ROMAN

WARSAW 24-26.07.2015

KLASYFIKACJA DRUŻYNOWA																			
Miejsce	Klub (Miejscowość)	Liczba zawodników	59		66		71		75		80		85		98		130	TOTAL	
1	<u>RUSSIA (RUS)</u>	20	10	/2	8	/2	3	/1	8	/3	9	/3	28	/4	16	/4	8	/1	90
2	<u>GERMANY (GER)</u>	16	0	/2	9	/1			13	/3	10	/1	10	/3	16	/4	9	/2	67
3	<u>HUNGARY (HUN)</u>	12	0	/2	18	/2	21	/5	0	/1				9	/1	8	/1	56	
4	<u>TURKEY (TUR)</u>	11	8	/3	3	/1	8	/1	0	/1	6	/3	6	/1	0	/1		31	
5	<u>CHINA (CHN)</u>	11	0	/2	4	/1	8	/1	0	/1	5	/2	0	/2	1	/1	10	/1	28
6	<u>BULGARIA (BUL)</u>	13	17	/2	0	/1	0	/1	1	/3	0	/1	1	/2	0	/2	6	/1	25
7	<u>IRAN (IRI)</u>	8	0	/2					13	/2	9	/2					2	/2	24
8	<u>POLAND (POL)</u>	27	3	/5	0	/2			0	/5	8	/4	3	/5	2	/4	6	/2	22
9-10	<u>BELARUS (BLR)</u>	21	4	/3	0	/1	9	/1	0	/3	0	/3	0	/6	4	/4		17	
9-10	<u>CROATIA (CRO)</u>	7	0	/2							8	/2	9	/2	0	/1		17	
11	<u>NORWAY (NOR)</u>	7	6	/1	2	/1			8	/2	0	/2			0	/1		16	
12	<u>SWEDEN (SWE)</u>	5			0	/1			8	/1	0	/1	0	/1	6	/1		14	
13	<u>GEORGIA (GEO)</u>	3			6	/1	6	/1						0	/1			12	
14	<u>EGYPT (EGY)</u>	3			6	/1							0	/1			4	/1	10
15	<u>ESTONIA (EST)</u>	4							6	/1				0	/2	3	/1	9	
16	<u>KYRGYZSTAN (KGZ)</u>	3	6	/1			0	/1					0	/1				6	
17	<u>JAPAN (JPN)</u>	8	1	/1	0	/1	0	/1	0	/1	2	/1	0	/1	0	/1	1	/1	4
18	<u>CZECH REPUBLIC (CZE)</u>	7	0	/1	0	/1	0	/2			0	/1	0	/1	3	/1		3	
19-20	<u>DENMARK (DEN)</u>	3	2	/1							0	/1	0	/1				2	
19-20	<u>LATVIA (LAT)</u>	2					2	/1					0	/1				2	
21	<u>SLOVAKIA (SVK)</u>	1			1	/1												1	
22-29	<u>GREECE (GRE)</u>	3					0	/1					0	/1	0	/1		0	
22-29	<u>UNITED STATES (USA)</u>	3	0	/1					0	/2								0	
22-29	<u>KAZAKHSTAN (KAZ)</u>	1							0	/1								0	
22-29	<u>LITHUANIA (LTU)</u>	6					0	/1	0	/1	0	/1		0	/1	0	/2	0	
22-29	<u>UKRAINE (UKR)</u>	7	0	/3	0	/1			0	/1	0	/1		0	/1			0	
22-29	<u>SPAIN (ESP)</u>	5	0	/2							0	/1		0	/2			0	
22-29	<u>FRANCE (FRA)</u>	2									0	/1		0	/1			0	
22-29	<u>ITALY (ITA)</u>	2							0	/1				0	/1			0	
TOTAL:		221																	



LVIII MMORIAL WŁADYSŁAWA PYTLASIŃSKIEGO

GRECO ROMAN

WARSAW 24-26.07.2015



Klasyfikacja indywidualna kat: 59 kg

P	NAME & SURNAME	CLUB	YEAR	POINTS	TOUCH-FALL	SUPERIORITY:	points	LOST
1	Mingyan Semenov	RUSSIA (RUS)	1984	20	0	3	29	0
2	Ivo Angelov	BULGARIA (BUL)	0	16	0	1	27	5
3	Hammet Rustem	TURKEY (TUR)	1980	14	0	2	36	15
3	Aleksandar Kostadinov	BULGARIA (BUL)	1980	15	0	1	22	18
5	K. Zholchubekov	KYRGYZSTAN (KGZ)	1990	17	1	2	24	10
5	Andre Berge Stig	NORWAY (NOR)	1980	9	0	0	12	6
7	Soslan Daurov	BELARUS (BLR)	1980	9	0	2	22	5
8	Michał Tracz	POLAND (POL)	1992	8	0	1	15	6
9	Tobias Fønnesbek	DENMARK (DEN)	1984	7	0	1	15	12
10	Shota Tanokura	JAPAN (JPN)	1990	7	0	0	15	11
11	Mohsen Hajipour	IRAN (IRI)		5	0	1	15	10
12	Maksim Kazharski	BELARUS (BLR)	1980	5	0	1	9	4
13	Fatih Ucuncu	TURKEY (TUR)	1984	4	0	1	9	5
14	Dawid Ersetić	POLAND (POL)	1992	4	0	0	13	22
15	Ibragim Labazanov	RUSSIA (RUS)	1980	4	0	0	6	7
16	Erik Weiss	GERMANY (GER)	1980	3	0	0	12	14
17	Przemysław Piątek	POLAND (POL)	1995	3	0	0	6	12
18	Mate Krasznai	HUNGARY (HUN)	1995	3	0	0	6	14
19	Csongor Knipli	HUNGARY (HUN)	1995	3	0	0	3	10
20	Edward Barsegian	POLAND (POL)	1980	1	0	0	8	11
21	Serif Kilic	TURKEY (TUR)		1	0	0	8	12
22	Ivan Lizatović	CROATIA (CRO)	1984	1	0	0	6	9
23	Hamid Sorian	IRAN (IRI)	1980	1	0	0	4	4
24	Oleksandr Tryfonov	UKRAINE (UKR)	1990	1	0	0	3	14
25	Dmytro Tsybaliuk	UKRAINE (UKR)	1986	1	0	0	2	3
26	Joaquin Martinez Abellan	SPAIN (ESP)	1980	1	0	0	2	6
27	Li Jiang	CHINA (CHN)		1	0	0	1	7
28	Qive Tian	CHINA (CHN)		1	0	0	1	10
29	Tonimir Sokol	CROATIA (CRO)	0	0	0	0	0	5
30-33	Nickolas Triggas	UNITED STATES (USA)	1990	0	0	0	0	8
30-33	Elbek Tazhiev	BELARUS (BLR)	1986	0	0	0	0	8
30-33	Michal Novak	CZECH REPUBLIC (CZE)	1990	0	0	0	0	8
30-33	Albert Baghumyan	SPAIN (ESP)	2000	0	0	0	0	8
34-35	Arkadiusz Gućik	POLAND (POL)	1993	0	0	0	0	9
34-35	Deniz Menekse	GERMANY (GER)	1993	0	0	0	0	9
36	Oleksii Vasylets	UKRAINE (UKR)	1990	0	0	0	0	14

Klasyfikacja indywidualna kat: 66 kg

P	NAME & SURNAME	CLUB	YEAR	POINTS	TOUCH-FALL	SUPERIORITY:	points	LOST
1	Frank Stabler	GERMANY (GER)	0	19	0	4	45	4
2	Adam Kurak	RUSSIA (RUS)	1980	15	1	1	26	14
3	Dominic Ellinger	CROATIA (CRO)	1992	16	0	3	32	9
3	Mateusz Bernatek	POLAND (POL)	1994	14	1	0	19	11
5	Guna Abdussamet	TURKEY (TUR)	1980	9	1	1	11	16
5	Mehdi Zeidvamd	IRAN (IRI)		13	0	2	25	18
7	Pan Zheng	CHINA (CHN)		8	1	0	12	3
8	Geraei Mohammadali	IRAN (IRI)		6	1	0	10	5
9	Takeshi Izumi	JAPAN (JPN)		6	0	0	10	21
10	Gaoquan Zhang	CHINA (CHN)		6	0	0	2	15
11	Dawid Kareciński	POLAND (POL)	1991	4	0	1	9	8
12	Yaroslau Kardash	BELARUS (BLR)	1984	4	0	1	8	6
13	Kostyantyn Stas	BULGARIA (BUL)	1992	4	0	0	8	12
14-15	Pavel Liakh	BELARUS (BLR)	1980	4	0	0	6	5
14-15	Arslan Abdullin	RUSSIA (RUS)	1984	4	0	0	6	5
16	Marius Thommesen	NORWAY (NOR)	1980	4	0	0	4	8
17	Michał Kośła	POLAND (POL)	1993	3	0	0	6	11
18	Frunze Harutyunyan	SWEDEN (SWE)	1990	3	0	0	2	3
19	Danijel Janević	CROATIA (CRO)	0	1	0	0	4	5
20	Abuyazid Mantsiqov	RUSSIA (RUS)	1996	1	0	0	3	5
21	Artak Margaryan	FRANCE (FRA)	1984	1	0	0	3	6
22	Fevzi Mamutov	UKRAINE (UKR)	1980	1	0	0	2	7
23	Ugurli Abdullssamet	TURKEY (TUR)		0	0	0	2	5
24	Grzegorz Wanek	POLAND (POL)	1992	0	0	0	0	2
25	Matous Morbitzer	CZECH REPUBLIC (CZE)	1994	0	0	0	0	4
26	Mikhail Siamionau	BELARUS (BLR)	1986	0	0	0	0	6
27	Fredrik Bierrehus	DENMARK (DEN)	1984	0	0	0	0	7
28-29	Ismael Navarro	SPAIN (ESP)	1980	0	0	0	0	8
28-29	Edgaras Venckaitis	LITHUANIA (LTU)	1980	0	0	0	0	8
30-31	Cengiz Arslan	TURKEY (TUR)	1994	0	0	0	0	9
30-31	Paal Airik Gundersen	NORWAY (NOR)	1993	0	0	0	0	9

Klasyfikacja indywidualna kat: 71 kg

P	NAME & SURNAME	CLUB	YEAR	POINTS	TOUCH-FALL	SUPERIORITY:	points	LOST
1	Tomas Lorincz	HUNGARY (HUN)	1980	16	1	2	28	1
2	Matthias Maasch	GERMANY (GER)	1980	9	0	0	11	12
3	Balint Korpasi	HUNGARY (HUN)	0	11	0	1	22	5
3	Denis Murtazin	RUSSIA (RUS)		10	0	0	18	14
5	Ibrahim M. Hamed Ghanem	EGYPT (EGY)		5	0	0	12	10
5	Manuchar Tskhadaia	GEORGIA (GEO)	0	11	0	1	18	18
7	Ridong Zhang	CHINA (CHN)	2000	4	0	0	9	8
8	Yunus Ozel	TURKEY (TUR)	1980	4	0	0	5	4
9	Petter Karlsen	NORWAY (NOR)	1996	4	0	0	5	8
10	Jakus Voitech	SLOVAKIA (SVK)	1990	3	0	0	5	10
11	Kazuhiro Hanayama	JAPAN (JPN)		3	0	0	2	12
12	Zakariás Taliroth	SWEDEN (SWE)	1986	1	0	0	5	7
13	Bohdan Kabyň	UKRAINE (UKR)		1	0	0	4	5
14	Ilva Glazkov	RUSSIA (RUS)		1	0	0	2	4
15	Przemysław Kraczkowski	POLAND (POL)	1988	1	0	0	2	6
16	Edgar Meikumov	POLAND (POL)	1990	0	0	0	0	2
17	Filip Dubsky	CZECH REPUBLIC (CZE)	1990	0	0	0	0	3
18	Ihar Drazdovich	BELARUS (BLR)		0	0	0	0	8
19	Svilen Kostadinov	BULGARIA (BUL)	0	0	0	0	0	11



LVIII MMORIAL WŁADYSŁAWA PYTLASIŃSKIEGO

GRECO ROMAN

WARSAW 24-26.07.2015



Klasyfikacja indywidualna kat: 75 kg								
P	NAME & SURNAME	CLUB	YEAR	POINTS	TOUCH-FALL	SUPERIORITY:	points	LOST
1	Roman Vlasov	RUSSIA (RUS)	1990	17	0	2	32	6
2	Bozo Starcevic	CROATIA (CRO)	1980	15	1	1	15	9
3	Ruslan Isakov	RUSSIA (RUS)	1980	12	0	0	12	6
3	Alexander Chekhirkin	RUSSIA (RUS)	1980	18	1	1	18	8
5	Florian Neumaier	GERMANY (GER)	1980	9	0	0	5	7
5	Emrah Kus	TURKEY (TUR)	1990	11	0	1	17	11
7	Pascal Eisele	GERMANY (GER)	1984	9	1	1	17	9
8	Arkadiusz Kulwicz	POLAND (POL)	1992	9	0	1	11	6
9	Ilyas Magamadov	RUSSIA (RUS)		7	0	0	14	9
10	Yavor Yanakiev	BULGARIA (BUL)	1980	6	0	0	8	2
11	Ilian Georgiev	BULGARIA (BUL)	0	6	0	0	8	15
12	Iwan Nvlypiuk	POLAND (POL)	1994	5	1	0	5	13
13	Mark Madsen	DENMARK (DEN)	1984	4	0	1	15	2
14	Kazbek Kilou	BELARUS (BLR)	1992	4	0	1	8	2
15	Edgar Babayan	POLAND (POL)	1986	4	0	0	6	9
16	Bogdan Kaurinnoi	SWEDEN (SWE)		3	0	0	5	6
17	Bin Yang	CHINA (CHN)	1990	3	0	0	4	1
18-19	Takehiro Kanakubo	JAPAN (JPN)	1990	1	0	0	4	5
18-19	Aliaksandr Dzemyanovich	BELARUS (BLR)	1980	1	0	0	4	5
20	Jacek Tomaszewski	POLAND (POL)	1992	1	0	0	4	7
21	Petr Novak	CZECH REPUBLIC (CZE)	1980	1	0	0	3	4
22	Jevgenijs Kolcous	LATVIA (LAT)	1980	1	0	0	1	10
23	Chang Yongxianq	CHINA (CHN)		0	0	0	6	5
24	Valery Palenski	BELARUS (BLR)	1980	0	0	0	0	1
25	Damian Hartmann	GERMANY (GER)	1986	0	0	0	0	2
26-28	Daniab Kobonov	KYRGYZSTAN (KGZ)	1980	0	0	0	0	4
26-28	Omar K. Shehata Mohamed	EGYPT (EGY)		0	0	0	0	4
26-28	Marad Huseinav	BELARUS (BLR)	1992	0	0	0	0	4
29	Neven Zugaj	CROATIA (CRO)	1983	0	0	0	0	6
30	Aliaksandr Henuveina	BELARUS (BLR)	1996	0	0	0	0	8
31	Rudik Kuliev	BELARUS (BLR)		0	0	0	0	9
32	Krzysztof Niklas	POLAND (POL)	1997	0	0	0	0	11
33	Petros Manouilidis	GREECE (GRE)	1990	0	0	0	0	16

Klasyfikacja indywidualna kat: 80 kg								
P	NAME & SURNAME	CLUB	YEAR	POINTS	TOUCH-FALL	SUPERIORITY:	points	LOST
1	Peter Bacs	HUNGARY (HUN)	1980	17	0	2	29	1
2	Viktar Sasunouski	BELARUS (BLR)	1989	14	1	1	12	3
3	Selcuk Cebi	TURKEY (TUR)	1990	12	1	1	20	7
3	Aisha Aishan	CHINA (CHN)	0	11	0	0	12	11
5	Giorgi Tsirekidze	GEORGIA (GEO)	1980	7	0	1	12	3
5	Laszlo Szabo	HUNGARY (HUN)	0	7	0	0	8	11
7	Patrik Szabo	HUNGARY (HUN)	1992	4	0	1	8	7
8	Ramazan Abacharaev	RUSSIA (RUS)	1986	4	0	0	5	5
9	Aleksandr Visnakovs	LATVIA (LAT)	1980	4	0	0	5	14
10	Martin Szabo	HUNGARY (HUN)	1980	3	0	0	6	9
11	Julius Matuzevicius	LITHUANIA (LTU)	1992	1	0	0	2	3
12	Daniel Aleksandrov	BULGARIA (BUL)		1	0	0	2	10
13	Zoltan Keri	HUNGARY (HUN)	1993	1	0	0	1	6
14	Pavel Powada	CZECH REPUBLIC (CZE)	1986	1	0	0	1	9
15-16	Sototbok Sulaimanov	KYRGYZSTAN (KGZ)		0	0	0	0	4
15-16	Nikolaos Varkas	GREECE (GRE)	1980	0	0	0	0	4
17-18	Yuva Maeta	JAPAN (JPN)		0	0	0	0	8
17-18	Oldrich Varga	CZECH REPUBLIC (CZE)	1993	0	0	0	0	8

Klasyfikacja indywidualna kat: 85 kg								
P	NAME & SURNAME	CLUB	YEAR	POINTS	TOUCH-FALL	SUPERIORITY:	points	LOST
1	Aleksiev Mishin	RUSSIA (RUS)	1979	16	0	1	24	9
2	Viktor Lorincz	HUNGARY (HUN)	0	13	0	0	16	6
3	Denis Kudla	GERMANY (GER)	1996	14	0	1	17	5
3	Ramsin Azizsir	GERMANY (GER)	1980	16	0	1	18	4
5	Kristofer Johansson	SWEDEN (SWE)	1986	11	0	1	26	14
5	Movsar Duguchev	RUSSIA (RUS)	0	12	1	0	15	8
7	Aliaksandr Kikinirov	BELARUS (BLR)		9	0	0	12	10
8	Artur Omarov	CZECH REPUBLIC (CZE)	1980	8	0	0	15	18
9	Tadeusz Michalik	POLAND (POL)	1991	7	0	0	12	8
10	Fei Peng	CHINA (CHN)	1990	7	0	0	11	20
11	Mikalai Stadub	BELARUS (BLR)	1980	6	1	0	5	6
12	Jan Fisher	GERMANY (GER)	1980	6	0	0	10	6
13	Patrik Boniecki	POLAND (POL)	1995	4	0	1	8	9
14	Vladimir Geqeshidze	GEORGIA (GEO)	1984	4	0	0	17	17
15	Rasmus Tjoerstad	NORWAY (NOR)	1986	4	0	0	9	7
16	Nenad Zugaj	CROATIA (CRO)	0	4	0	0	8	3
17	Alo Toom	ESTONIA (EST)	1980	4	0	0	8	9
18	Hristo Marinov	BULGARIA (BUL)	0	3	0	0	3	4
19	Krystian Formela	POLAND (POL)	1993	2	0	0	2	19
20	Metehan Basar	TURKEY (TUR)		1	0	0	12	15
21	Pedro J. Garcia	SPAIN (ESP)	1980	1	0	0	4	5
22-23	Andrei Mikhailovski	BELARUS (BLR)		1	0	0	4	6
22-23	Dimitrios Tsekeridis	GREECE (GRE)	1994	1	0	0	4	6
24	Roman Yusipov	RUSSIA (RUS)		1	0	0	4	8
25-26	Sosruko Kodzokov	RUSSIA (RUS)	1994	1	0	0	3	5
25-26	Javid Hamazatau	BELARUS (BLR)	1980	1	0	0	3	5
27	Sergii Severyn	UKRAINE (UKR)		1	0	0	2	7
28-30	Eerik Aps	ESTONIA (EST)	1980	1	0	0	1	3
28-30	Melonin Noumonvi	FRANCE (FRA)	1982	1	0	0	1	3
28-30	Damian Janikowski	POLAND (POL)	1989	1	0	0	1	3
31	Eugen Ponomartschuk	GERMANY (GER)	1980	1	0	0	1	4
32	Fabio Parisi	ITALY (ITA)	1984	1	0	0	1	6
33	Taichi Oka	JAPAN (JPN)	1990	0	0	0	0	2
34	Stanislav Kanev	BULGARIA (BUL)		0	0	0	0	4
35	Laimutis Adomaitis	LITHUANIA (LTU)	1986	0	0	0	0	5
36	Jesus Gasca	SPAIN (ESP)	1992	0	0	0	0	8



LVIII MMORIAL WŁADYSŁAWA PYTLASIŃSKIEGO

GRECO ROMAN

WARSAW 24-26.07.2015



Klasyfikacja indywidualna kat: 98 kg								
P	NAME & SURNAME	CLUB	YEAR	POINTS	TOUCH-FALL	SUPERIORITY:	points	LOST
1	Ghasem Rezaei	IRAN (IRI)	1980	18	0	1	20	0
2	Peter Ohler	GERMANY (GER)	1980	13	0	1	23	6
3	Musa Evloev	RUSSIA (RUS)	1996	13	0	1	21	9
3	Frederik Schoen	SWEDEN (SWE)	1986	14	0	2	25	8
5	Ardo Arusaar	ESTONIA (EST)	1980	11	1	0	12	9
5	Felix Baldauf	NORWAY (NOR)	1994	16	2	1	29	13
7	Oliver Hassler	GERMANY (GER)	1986	10	0	1	13	10
8	M. Aliyarfeizabadi	IRAN (IRI)	1990	9	0	1	21	24
9	Martin Nielsen	NORWAY (NOR)	1992	8	1	0	16	10
10	Elis Guri	BULGARIA (BUL)	1980	6	1	0	7	7
11	Mykola Krysov	UKRAINE (UKR)	1994	6	0	0	12	23
12	Vilius Laurinaitis	LITHUANIA (LTU)	1992	5	0	1	11	3
13	Tsimafei Dzeinchenka	BELARUS (BLR)	1980	5	0	1	9	2
14	Di Xiao	CHINA (CHN)	1990	4	0	0	6	1
15	Vladislav Metodiev	BULGARIA (BUL)	1984	3	0	0	5	9
16	Cenk Ildem	TURKEY (TUR)	1984	3	0	0	3	4
17	Konstantin Efmov	RUSSIA (RUS)	1980	1	0	0	6	9
18	Josef Rau	UNITED STATES (USA)	1980	1	0	0	6	17
19	Ilva Nastochenko	KAZAKHSTAN (KAZ)	1986	1	0	0	3	3
20	Evgeni Genchev	BULGARIA (BUL)	1995	1	0	0	3	6
21	Daigoro Timoncini	ITALY (ITA)	1980	1	0	0	2	3
22	Patrick Cawey	UNITED STATES (USA)	1980	1	0	0	2	9
23	Aleksander Kroczak	POLAND (POL)	1994	1	0	0	2	10
24	Radosław Grzybicki	POLAND (POL)	1989	1	0	0	1	4
25	Aliaksandr Hrabovik	BELARUS (BLR)	1980	0	0	0	4	7
26-27	Yasuhiro Yonehira	JAPAN (JPN)		0	0	0	0	4
26-27	Yauhen Valkhanovich	BELARUS (BLR)		0	0	0	0	4
28	Maksim Safarian	RUSSIA (RUS)	1981	0	0	0	0	5
29	Łukasz Konega	POLAND (POL)	1989	0	0	0	0	7
30-32	Felix Radinger	GERMANY (GER)	1986	0	0	0	0	8
30-32	Marcel Kasperek	POLAND (POL)	1997	0	0	0	0	8
30-32	Balazs Kiss	HUNGARY (HUN)	0	0	0	0	0	8
33	Erwin Imbierski	POLAND (POL)	1996	0	0	0	0	12

Klasyfikacja indywidualna kat: 130 kg								
P	NAME & SURNAME	CLUB	YEAR	POINTS	TOUCH-FALL	SUPERIORITY:	points	LOST
1	Qiang Meng	CHINA (CHN)	0	14	0	2	25	4
2	Christian John	GERMANY (GER)	1996	13	1	2	22	9
3	Balint Lam	HUNGARY (HUN)	1980	7	0	0	14	9
3	Vitalii Shchur	RUSSIA (RUS)	0	12	1	0	6	15
5	Łukasz Banak	POLAND (POL)	1983	6	0	0	2	17
5	Lyubomir Dimitrov	BULGARIA (BUL)	1984	10	2	0	8	4
7	Abdellotef M. Ahmed Abd	EGYPT (EGY)		4	0	1	13	5
8	Heiki Nabi	ESTONIA (EST)	1984	4	0	0	3	2
9	Mahdi Nouri	IRAN (IRI)		3	0	0	1	4
10	Arata Sonoda	JAPAN (JPN)	1994	1	0	0	3	12
11	Shahab Chourehjili	IRAN (IRI)		1	0	0	2	13
12	Rafal Plowiec	POLAND (POL)	1996	0	0	0	2	4
13-15	Mantas Knystautas	LITHUANIA (LTU)	1994	0	0	0	0	1
13-15	Eduard Popp	GERMANY (GER)	0	0	0	0	0	1
13-15	Mizqatis Mindaugas	LITHUANIA (LTU)	0	0	0	0	0	1



Feuille de compétition / Competition Sheet

LVIII Memoriał Władysława Pytłasińskiego/Poland OPEN



Style: null GR59

QUALIFICATION				1/16 FINALE				1/8 FINALE			
1		Albert Baghumyan (ESP)	P1 P2	1	0	ESP	P1 P2	2	3	POL	P1 P2
			P1 P2		0		0 0		4		4 0
			P1 P2		8		6 2				
2		Michał Tracz (POL)	P1 P2	2	4	POL	P1 P2				
			P1 P2				8 0				
3		Nickolas Triggas (USA)	P1 P2	3	0	USA	P1 P2				
			P1 P2				0 0	4	1	BLR	P1 P2
4		Maksim Kazharski (BLR)	P1 P2	4	4	BLR	P1 P2				0 1
			P1 P2		8		8 0				
5		Aleksandar Kostadinov (BUL)	P1 P2	5	3	BUL	P1 P2				
			P1 P2		9		3 6	5	4	BUL	P1 P2
6		Ivan Lizatovic (CRO)	P1 P2	6	1	CRO	P1 P2		8		5 3
			P1 P2		6		6 0				
7		Csongor Knipli (HUN)	P1 P2	7	3	HUN	P1 P2				
			P1 P2		3		2 1	7	0	HUN	P1 P2
8		Dmytro Tsybaliuk (UKR)	P1 P2	8	1	UKR	P1 P2		0		0 0
			P1 P2		2		0 2				
9		Hamid Sorian (IRI)	P1 P2	9	1	IRI	P1 P2				
			P1 P2		4		4 0	10	1	RUS	P1 P2
10		Ibragim Labazanov (RUS)	P1 P2	10	3	RUS	P1 P2		2		2 0
			P1 P2		4		4 0				
11		Andre Berge Stig (NOR)	P1 P2	11	3	NOR	P1 P2				
			P1 P2		5		0 5	11	3	NOR	P1 P2
12		Tonimir Sokol (CRO)	P1 P2	12	0	CRO	P1 P2		3		1 2
			P1 P2		0		0 0				
13		Mingyan Semenov (RUS)	P1 P2	13	4	RUS	P1 P2				
			P1 P2		8		8 0	13	4	RUS	P1 P2
14		Oleksii Vasylets (UKR)	P1 P2	14	0	UKR	P1 P2		8		8 0
			P1 P2		0		0 0				
15		Arkadiusz Gucik (POL)	P1 P2	15	0	POL	P1 P2				
			P1 P2		0		0 0	16	0	DEN	P1 P2
16		Tobias Fannesbek (DEN)	P1 P2	16	4	DEN	P1 P2		0		0 0
			P1 P2		9		1 8				
17		Serif Kilic (TUR)	P1 P2	17	1	TUR	P1 P2				
			P1 P2		8		6 2	18	0	GER	P1 P2
18		Erik Weiss (GER)	P1 P2	18	3	GER	P1 P2		0		0 0
			P1 P2		12		3 9				
19		Li Jiang (CHN)	P1 P2	19	1	CHN	P1 P2				
			P1 P2		1		0 1	20	3	JPN	P1 P2
20		Shota Tanokura (JPN)	P1 P2	20	3	JPN	P1 P2		6		2 4
			P1 P2		7		1 6				
21		Mohsen Hajipour (IRI)	P1 P2	21	4	IRI	P1 P2				
			P1 P2		8		5 3	21	1	IRI	P1 P2
22		Elbek Tazhyiev (BLR)	P1 P2	22	0	BLR	P1 P2		7		7 0
			P1 P2		0		0 0				
23		Hammet Rustem (TUR)	P1 P2	23	4	TUR	P1 P2				
			P1 P2		14		14 0	23	3	TUR	P1 P2
24		Oleksandr Tryfonov (UKR)	P1 P2	24	1	UKR	P1 P2		10		4 6
			P1 P2		3		3 0				
25		Joaquin Martinez Abellan (ESP)	P1 P2	25	1	ESP	P1 P2				
			P1 P2		2		0 2	26	0	POL	P1 P2
26		Przemysław Piątek (POL)	P1 P2	26	3	POL	P1 P2		0		0 0
			P1 P2		6		2 4				
27		Qiye Tian (CHN)	P1 P2	27	1	CHN	P1 P2				
			P1 P2		1		1 0	28	4	BLR	P1 P2
28		Soslan Daurov (BLR)	P1 P2	28	4	BLR	P1 P2		10		10 0
			P1 P2		10		0 10				
29	1	Edward Barsegjan (POL)	P1 P2	30	0	POL	P1 P2				
	8		P1 P2		0		0 0	32	3	BUL	P1 P2
30	3	Dawid Ersetic (POL)	P1 P2						8		2 6
	11		P1 P2								
31	0	Mate Krasznai (HUN)	P1 P2	32	4	BUL	P1 P2				
	0		P1 P2		8		6 2				
32	3	Ivo Angelov (BUL)	P1 P2								
	4		P1 P2								
33	0	Deniz Menekse (GER)	P1 P2	34	0	TUR	P1 P2				
	0		P1 P2		0		0 0	36	1	KGZ	P1 P2
34	4	Fatih Uuncu (TUR)	P1 P2						3		0 3
	9		P1 P2								
35	0	Michal Novak (CZE)	P1 P2	36	3	KGZ	P1 P2				
	0		P1 P2		5		4 1				
36	4	K. Zholchubekov (KGZ)	P1 P2								
	8		P1 P2								



Feuille de compétition / Competition Sheet

LVIII Memoriał Władysława Pytłasińskiego/Poland OPEN



Style: null GR59

1/16 FINALE			1/8 FINALE			1/4 FINALE			1/2 FINALE			FINALE			WINNER														
1	0/0	Albert Baghumyan (ESP)	P1	P2	0/0	2	3/4	POL	P1	P2	4/0	2	1/3	POL	P1	P2	0/3	5	0/0	BUL	P1	P2	0/0	13	5/0	RUS	P1	P2	0/0
2	4/8	Michał Tracz (POL)	P1	P2	6/2	4	1/1	BLR	P1	P2	0/1	5	3/5	BUL	P1	P2	1/4		13	4/9	RUS	P1	P2		2/7				
3	0/0	Nickolas Triggas (USA)	P1	P2	0/0		5	4/8	BUL	P1	P2		5/3	11	0/0	NOR	P1			P2	0/0								
4	4/8	Maksim Kazharski (BLR)	P1	P2	8/0	7		0/0	HUN	P1	P2	0/0	13		3/4	RUS	P1			P2	2/2								
5	3/9	Aleksandar Kostadinov (BUL)	P1	P2	3/6		10	1/2	RUS	P1	P2	2/0		13	4/8	RUS	P1			P2	8/0								
6	1/6	Ivan Lizatovic (CRO)	P1	P2	6/0	11		3/3	NOR	P1	P2	1/2	13		3/4	RUS	P1			P2	2/2								
7	3/3	Csongor Knipli (HUN)	P1	P2	2/1		13	4/8	RUS	P1	P2	8/0		16	0/0	DEN	P1			P2	0/0								
8	1/2	Dmytro Tsybaliuk (UKR)	P1	P2	0/2	18		0/0	GER	P1	P2	0/0	20		1/2	JPN	P1			P2	2/0								
9	1/4	Hamid Sorian (IRI)	P1	P2	4/0		20	3/6	JPN	P1	P2	2/4		23	0/0	TUR	P1			P2	0/0								
10	3/4	Ibragim Labazanov (RUS)	P1	P2	4/0	21		1/7	IRI	P1	P2	7/0	23		4/10	TUR	P1			P2	4/6								
11	3/5	Andre Berge Stig (NOR)	P1	P2	0/5		23	3/10	TUR	P1	P2	4/6		32	0/0	BUL	P1			P2	0/0								
12	0/0	Tonimir Sokol (CRO)	P1	P2	0/0	26		0/0	POL	P1	P2	0/0	32		3/3	BUL	P1			P2	0/3								
13	4/8	Mingiyán Semenov (RUS)	P1	P2	8/0		28	1/2	BLR	P1	P2	0/2		36	1/3	KGZ	P1			P2	0/3								
14	0/0	Oleksii Vasylets (UKR)	P1	P2	0/0	32		3/8	BUL	P1	P2	2/6	36		3/5	K. Zhoichubekov (KGZ)	P1			P2	4/1								
15	0/0	Arkadiusz Gucik (POL)	P1	P2	0/0		36	1/3	KGZ	P1	P2	0/3																	
16	4/9	Tobias Fønnesbæk (DEN)	P1	P2	1/8																								
17	1/8	Serif Kilic (TUR)	P1	P2	6/2																								
18	3/12	Erik Weiss (GER)	P1	P2	3/9																								
19	1/1	Li Jiang (CHN)	P1	P2	0/1																								
20	3/7	Shota Tanokura (JPN)	P1	P2	1/6																								
21	4/8	Mohsen Hajipour (IRI)	P1	P2	5/3																								
22	0/0	Elbek Tazhyiev (BLR)	P1	P2	0/0																								
23	4/14	Hammet Rustem (TUR)	P1	P2	14/0																								
24	1/3	Oleksandr Tryfonov (UKR)	P1	P2	3/0																								
25	1/2	Joaquin Martínez Abellan (ESP)	P1	P2	0/2																								
26	3/6	Przemysław Piątek (POL)	P1	P2	2/4																								
27	1/1	Qiye Tian (CHN)	P1	P2	1/0																								
28	4/10	Soslan Daurov (BLR)	P1	P2	0/10																								
30	0/0	Dawid Ersetić (POL)	P1	P2	0/0																								
32	4/8	Ivo Angelov (BUL)	P1	P2	6/2																								
34	0/0	Fatih Ucuncu (TUR)	P1	P2	0/0																								
36	3/5	K. Zhoichubekov (KGZ)	P1	P2	4/1																								

13 Mingiyán Semenov (RUS)



Feuille de compétition / Competition Sheet

LVIII Memoriał Władysława Pytłasińskiego/Poland OPEN



Style: null

GR59

"REPECHAGE"

"UPPER BRANCH"

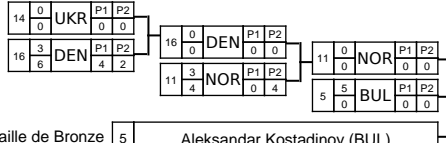

Médaille de Bronze 5 Aleksandar Kostadinov (BUL)

"LOWER BRANCH"

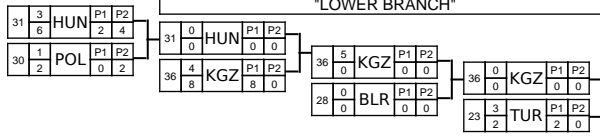

Médaille de Bronze 23 Hammet Rustem (TUR)

Classement

Cl	Pays	Nom
1	RUS	Mingiyar Semenov (RUS)
2	BUL	Ivo Angelov (BUL)
3	TUR	Hammet Rustem (TUR)
3	BUL	Aleksandar Kostadinov (BUL)
5	KGZ	K. Zhoichubekov (KGZ)
5	NOR	Andre Berge Stig (NOR)
7	BLR	Soslan Daurov (BLR)
8	POL	Michał Tracz (POL)
9	DEN	Tobias Fønnesbek (DEN)
10	JPN	Shota Tanokura (JPN)
11	IRI	Mohsen Hajipour (IRI)
12	BLR	Maksim Kazharski (BLR)
13	TUR	Fatih Ucuncu (TUR)
14	POL	Dawid Ersetic (POL)
15	RUS	Ibragim Labazanov (RUS)
16	GER	Erik Weiss (GER)
17	POL	Przemysław Piątek (POL)
18	HUN	Mate Krasznai (HUN)
19	HUN	Csongor Knipli (HUN)
20	POL	Edward Barsegjan (POL)
21	TUR	Serif Kiliç (TUR)
22	CRO	Ivan Lizatovic (CRO)
23	IRI	Hamid Sorian (IRI)
24	UKR	Oleksandr Tryfonov (UKR)
25	UKR	Dmytro Tsybaliuk (UKR)
26	ESP	Joaquin Martinez Abellan (ESP)
27	CHN	Li Jiang (CHN)
28	CHN	Qiye Tian (CHN)
29	CRO	Tonimir Sokol (CRO)
30-33	BLR	Elbek Tazhyiev (BLR)
30-33	CZE	Michal Novak (CZE)
30-33	ESP	Albert Baghumyan (ESP)
30-33	USA	Nickolas Triggas (USA)
34-35	POL	Arkadiusz Gucik (POL)
34-35	GER	Deniz Menekse (GER)
36	UKR	Oleksii Vasylets (UKR)



Feuille de compétition / Competition Sheet

LVIII Memoriał Władysława Pytłasińskiego/Poland OPEN



Style: null GR66

QUALIFICATION		1/8 FINALE	1/4 FINALE	1/2 FINALE	FINALE	WINNER
1	Frunze Harutyunyan (SWE)	P1 P2 0 0	1 3 2 SWE P1 P2 2 0	1 0 0 SWE P1 P2 0 0		
2	Pavel Liakh (BLR)	P1 P2 0 5	2 1 1 BLR P1 P2 0 1			
3	Abuyazid Mantsigov (RUS)	P1 P2 2 1		7 0 0 POL P1 P2 0 0		
4	Ismael Navarro (ESP)	P1 P2 0 0	5 0 0 BLR P1 P2 0 0			
5	Yaraslau Kardash (BLR)	P1 P2 4 4		7 3 2 POL P1 P2 2 0		
6	Ugurli Abdulsamet (TUR)	P1 P2 0 2	7 3 6 POL P1 P2 4 2			
7	Mateusz Bernatek (POL)	P1 P2 0 5			8 4 8 GER P1 P2 8 0	
8	Frank Stabler (GER)	P1 P2 7 2	8 4 8 GER P1 P2 8 0			
9	Gaoquan Zhang (CHN)	P1 P2 0 2		8 4 12 GER P1 P2 6 6		
10	Artak Margaryan (FRA)	P1 P2 0 3				
11	Michał Kośla (POL)	P1 P2 4 2	11 0 0 POL P1 P2 0 0		8 4 8 GER P1 P2 7 1	
12	Mehdi Zeidvamd (IRI)	P1 P2 8 0	12 4 8 IRI P1 P2 7 1			
13	Edgaras Venckaitis (LTU)	P1 P2 0 0		12 1 2 IRI P1 P2 2 0		
14	Paal Airik Gundersen (NOR)	P1 P2 0 0				
15	Dawid Kareciński (POL)	P1 P2 4 5	15 0 0 POL P1 P2 0 0			
16	Kostyantyn Stas (BUL)	P1 P2 4 3	16 1 1 BUL P1 P2 1 0			
17	Fevzi Mamutov (UKR)	P1 P2 0 2		19 3 1 CRO P1 P2 0 1		
18	Cengiz Arslan (TUR)	P1 P2 0 0	19 4 10 CRO P1 P2 10 0			
19	Dominic Etlinger (CRO)	P1 P2 9 0		19 1 4 CRO P1 P2 4 0		
20	Pan Zheng (CHN)	P1 P2 7 0	20 3 5 CHN P1 P2 0 5			
21	Fredrik Bjerrehus (DEN)	P1 P2 0 0		20 0 0 CHN P1 P2 0 0		
22	Matous Morbitzer (CZE)	P1 P2 0 0	23 1 2 RUS P1 P2 2 0			
23	Arslan Abdullin (RUS)	P1 P2 4 0			27 0 0 RUS P1 P2 0 0	
24	Grzegorz Wanke (POL)	P1 P2 0 0	25 1 2 NOR P1 P2 0 2			
25	Marius Thommesen (NOR)	P1 P2 2 0		27 5 4 RUS P1 P2 4 0		
26	Guna Abdussamet (TUR)	P1 P2 0 0	27 3 6 RUS P1 P2 3 3			
27	Adam Kurak (RUS)	P1 P2 1 7		27 3 8 RUS P1 P2 2 6		
28	Danijel Janevic (CRO)	P1 P2 4 0	29 3 5 JPN P1 P2 3 2			
29	Takeshi Izumi (JPN)	P1 P2 4 1		29 0 0 JPN P1 P2 0 0		
30	Mikhail Siamionau (BLR)	P1 P2 0 0				
31	Geraei Mohammadali (IRI)	P1 P2 4 2	31 1 4 IRI P1 P2 1 3			
					8	Frank Stabler (GER)

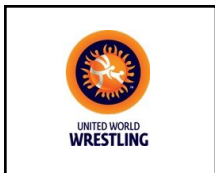

Feuille de compétition / Competition Sheet

LVIII Memoriał Władysława Pytlasińskiego/Poland OPEN



Style: null

GR66

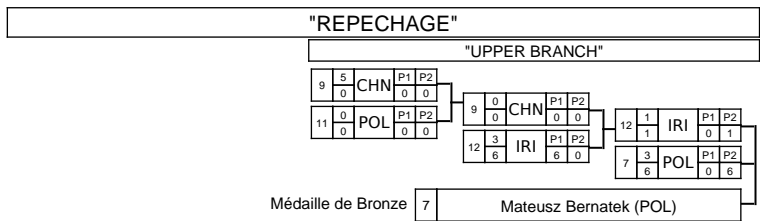

Classement

Cl	Pays	Nom
1	GER	Frank Stabler (GER)
2	RUS	Adam Kurak (RUS)
3	POL	Mateusz Bernatek (POL)
3	CRO	Dominic Etlinger (CRO)
5	TUR	Guna Abdussamet (TUR)
5	IRI	Mehdi Zeidvamd (IRI)
7	CHN	Pan Zheng (CHN)
8	IRI	Geraei Mohammadali (IRI)
9	JPN	Takeshi Izumi (JPN)
10	CHN	Gaoquan Zhang (CHN)
11	POL	Dawid Kareciński (POL)
12	BLR	Yaraslau Kardash (BLR)
13	BUL	Kostyantyn Stas (BUL)
14-15	RUS	Arslan Abdullin (RUS)
14-15	BLR	Pavel Liakh (BLR)
16	NOR	Marius Thommesen (NOR)
17	POL	Michał Kośła (POL)
18	SWE	Frunze Harutyunyan (SWE)
19	CRO	Danijel Janevic (CRO)
20	RUS	Abuyazid Mantsigov (RUS)
21	FRA	Artak Margaryan (FRA)
22	UKR	Fevzi Mamutov (UKR)
23	TUR	Ugurli Abdulsamet (TUR)
24	POL	Grzegorz Wanke (POL)
25	CZE	Matous Morbitzer (CZE)
26	BLR	Mikhail Siamionau (BLR)
27	DEN	Fredrik Bjerrehus (DEN)
28-29	ESP	Ismael Navarro (ESP)
28-29	LTU	Edgaras Venckaitis (LTU)
30-31	NOR	Paal Airik Gundersen (NOR)
30-31	TUR	Cengiz Arslan (TUR)

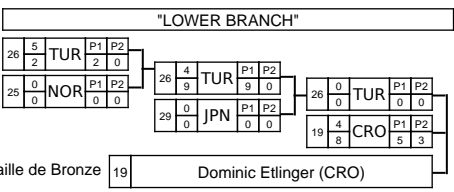



UNITED WORLD
WRESTLING

Feuille de compétition / Competition Sheet

LVIII Memoriał Władysława Pytłasińskiego/Poland OPEN

Style: null

GR71



QUALIFICATION	1/8 FINALE	1/4 FINALE	1/2 FINALE	FINALE	WINNER																																																																		
1 Matthias Maasch (GER) <table border="1" style="display: inline-table; font-size: 8px; border-collapse: collapse;"> <tr><td>P1</td><td>P2</td></tr> </table>	P1	P2	2 Ibrahim M. Hamed Ghanem <table border="1" style="display: inline-table; font-size: 8px; border-collapse: collapse;"> <tr><td>P1</td><td>P2</td></tr> </table>	P1	P2	3 Petter Karlsen (NOR) <table border="1" style="display: inline-table; font-size: 8px; border-collapse: collapse;"> <tr><td>P1</td><td>P2</td></tr> </table>	P1	P2	4 Filip Dubsky (CZE) <table border="1" style="display: inline-table; font-size: 8px; border-collapse: collapse;"> <tr><td>P1</td><td>P2</td></tr> </table>	P1	P2	5 Przemysław Kraczkowski (POL) <table border="1" style="display: inline-table; font-size: 8px; border-collapse: collapse;"> <tr><td>P1</td><td>P2</td></tr> </table>	P1	P2	6 Denis Murtazin (RUS) <table border="1" style="display: inline-table; font-size: 8px; border-collapse: collapse;"> <tr><td>P1</td><td>P2</td></tr> </table>	P1	P2	7 Zakarias Tallroth (SWE) <table border="1" style="display: inline-table; font-size: 8px; border-collapse: collapse;"> <tr><td>P1</td><td>P2</td></tr> </table>	P1	P2	8 Ridong Zhang (CHN) <table border="1" style="display: inline-table; font-size: 8px; border-collapse: collapse;"> <tr><td>P1</td><td>P2</td></tr> </table>	P1	P2	9 Jakus Vojtech (SVK) <table border="1" style="display: inline-table; font-size: 8px; border-collapse: collapse;"> <tr><td>P1</td><td>P2</td></tr> </table>	P1	P2	10 Bohdan Kabyn (UKR) <table border="1" style="display: inline-table; font-size: 8px; border-collapse: collapse;"> <tr><td>P1</td><td>P2</td></tr> </table>	P1	P2	11 Balint Korpasi (HUN) <table border="1" style="display: inline-table; font-size: 8px; border-collapse: collapse;"> <tr><td>P1</td><td>P2</td></tr> </table>	P1	P2	12 Ihar Drazdovich (BLR) <table border="1" style="display: inline-table; font-size: 8px; border-collapse: collapse;"> <tr><td>P1</td><td>P2</td></tr> </table>	P1	P2	13 Tomas Lorincz (HUN) <table border="1" style="display: inline-table; font-size: 8px; border-collapse: collapse;"> <tr><td>P1</td><td>P2</td></tr> </table>	P1	P2	14 Edgar Melkumov (POL) <table border="1" style="display: inline-table; font-size: 8px; border-collapse: collapse;"> <tr><td>P1</td><td>P2</td></tr> </table>	P1	P2	15 Kazuhiro Hanayama (JPN) <table border="1" style="display: inline-table; font-size: 8px; border-collapse: collapse;"> <tr><td>P1</td><td>P2</td></tr> </table>	P1	P2	16 Manuchar Tskhadaia (GEO) <table border="1" style="display: inline-table; font-size: 8px; border-collapse: collapse;"> <tr><td>P1</td><td>P2</td></tr> </table>	P1	P2	17 Svilen Kostadinov (BUL) <table border="1" style="display: inline-table; font-size: 8px; border-collapse: collapse;"> <tr><td>P1</td><td>P2</td></tr> </table>	P1	P2	18 Ilya Glazkov (RUS) <table border="1" style="display: inline-table; font-size: 8px; border-collapse: collapse;"> <tr><td>P1</td><td>P2</td></tr> </table>	P1	P2	19 Yunus Ozel (TUR) <table border="1" style="display: inline-table; font-size: 8px; border-collapse: collapse;"> <tr><td>P1</td><td>P2</td></tr> </table>	P1	P2															
P1	P2																																																																						
P1	P2																																																																						
P1	P2																																																																						
P1	P2																																																																						
P1	P2																																																																						
P1	P2																																																																						
P1	P2																																																																						
P1	P2																																																																						
P1	P2																																																																						
P1	P2																																																																						
P1	P2																																																																						
P1	P2																																																																						
P1	P2																																																																						
P1	P2																																																																						
P1	P2																																																																						
P1	P2																																																																						
P1	P2																																																																						
P1	P2																																																																						
P1	P2																																																																						
1 GER <table border="1" style="display: inline-table; font-size: 8px; border-collapse: collapse;"> <tr><td>P1</td><td>P2</td></tr> </table>		P1	P2	2 EGY <table border="1" style="display: inline-table; font-size: 8px; border-collapse: collapse;"> <tr><td>P1</td><td>P2</td></tr> </table>		P1	P2	3 NOR <table border="1" style="display: inline-table; font-size: 8px; border-collapse: collapse;"> <tr><td>P1</td><td>P2</td></tr> </table>		P1	P2	4 CZE <table border="1" style="display: inline-table; font-size: 8px; border-collapse: collapse;"> <tr><td>P1</td><td>P2</td></tr> </table>		P1	P2	5 POL <table border="1" style="display: inline-table; font-size: 8px; border-collapse: collapse;"> <tr><td>P1</td><td>P2</td></tr> </table>		P1	P2	6 RUS <table border="1" style="display: inline-table; font-size: 8px; border-collapse: collapse;"> <tr><td>P1</td><td>P2</td></tr> </table>		P1	P2	7 SWE <table border="1" style="display: inline-table; font-size: 8px; border-collapse: collapse;"> <tr><td>P1</td><td>P2</td></tr> </table>		P1	P2	8 CHN <table border="1" style="display: inline-table; font-size: 8px; border-collapse: collapse;"> <tr><td>P1</td><td>P2</td></tr> </table>		P1	P2	9 SVK <table border="1" style="display: inline-table; font-size: 8px; border-collapse: collapse;"> <tr><td>P1</td><td>P2</td></tr> </table>		P1	P2	10 UKR <table border="1" style="display: inline-table; font-size: 8px; border-collapse: collapse;"> <tr><td>P1</td><td>P2</td></tr> </table>		P1	P2	11 HUN <table border="1" style="display: inline-table; font-size: 8px; border-collapse: collapse;"> <tr><td>P1</td><td>P2</td></tr> </table>		P1	P2	12 BLR <table border="1" style="display: inline-table; font-size: 8px; border-collapse: collapse;"> <tr><td>P1</td><td>P2</td></tr> </table>		P1	P2	13 HUN <table border="1" style="display: inline-table; font-size: 8px; border-collapse: collapse;"> <tr><td>P1</td><td>P2</td></tr> </table>		P1	P2	14 POL <table border="1" style="display: inline-table; font-size: 8px; border-collapse: collapse;"> <tr><td>P1</td><td>P2</td></tr> </table>		P1	P2	15 JPN <table border="1" style="display: inline-table; font-size: 8px; border-collapse: collapse;"> <tr><td>P1</td><td>P2</td></tr> </table>		P1	P2	16 GEO <table border="1" style="display: inline-table; font-size: 8px; border-collapse: collapse;"> <tr><td>P1</td><td>P2</td></tr> </table>		P1	P2	17 GEO <table border="1" style="display: inline-table; font-size: 8px; border-collapse: collapse;"> <tr><td>P1</td><td>P2</td></tr> </table>		P1	P2	18 TUR <table border="1" style="display: inline-table; font-size: 8px; border-collapse: collapse;"> <tr><td>P1</td><td>P2</td></tr> </table>		P1	P2
P1	P2																																																																						
P1	P2																																																																						
P1	P2																																																																						
P1	P2																																																																						
P1	P2																																																																						
P1	P2																																																																						
P1	P2																																																																						
P1	P2																																																																						
P1	P2																																																																						
P1	P2																																																																						
P1	P2																																																																						
P1	P2																																																																						
P1	P2																																																																						
P1	P2																																																																						
P1	P2																																																																						
P1	P2																																																																						
P1	P2																																																																						
P1	P2																																																																						
1 GER <table border="1" style="display: inline-table; font-size: 8px; border-collapse: collapse;"> <tr><td>P1</td><td>P2</td></tr> </table>		P1	P2	3 NOR <table border="1" style="display: inline-table; font-size: 8px; border-collapse: collapse;"> <tr><td>P1</td><td>P2</td></tr> </table>		P1	P2	6 RUS <table border="1" style="display: inline-table; font-size: 8px; border-collapse: collapse;"> <tr><td>P1</td><td>P2</td></tr> </table>		P1	P2	7 SWE <table border="1" style="display: inline-table; font-size: 8px; border-collapse: collapse;"> <tr><td>P1</td><td>P2</td></tr> </table>		P1	P2	8 CHN <table border="1" style="display: inline-table; font-size: 8px; border-collapse: collapse;"> <tr><td>P1</td><td>P2</td></tr> </table>		P1	P2	9 SVK <table border="1" style="display: inline-table; font-size: 8px; border-collapse: collapse;"> <tr><td>P1</td><td>P2</td></tr> </table>		P1	P2	10 UKR <table border="1" style="display: inline-table; font-size: 8px; border-collapse: collapse;"> <tr><td>P1</td><td>P2</td></tr> </table>		P1	P2	11 HUN <table border="1" style="display: inline-table; font-size: 8px; border-collapse: collapse;"> <tr><td>P1</td><td>P2</td></tr> </table>		P1	P2	11 HUN <table border="1" style="display: inline-table; font-size: 8px; border-collapse: collapse;"> <tr><td>P1</td><td>P2</td></tr> </table>		P1	P2	13 HUN <table border="1" style="display: inline-table; font-size: 8px; border-collapse: collapse;"> <tr><td>P1</td><td>P2</td></tr> </table>		P1	P2	13 HUN <table border="1" style="display: inline-table; font-size: 8px; border-collapse: collapse;"> <tr><td>P1</td><td>P2</td></tr> </table>		P1	P2	16 GEO <table border="1" style="display: inline-table; font-size: 8px; border-collapse: collapse;"> <tr><td>P1</td><td>P2</td></tr> </table>		P1	P2	16 GEO <table border="1" style="display: inline-table; font-size: 8px; border-collapse: collapse;"> <tr><td>P1</td><td>P2</td></tr> </table>		P1	P2	19 TUR <table border="1" style="display: inline-table; font-size: 8px; border-collapse: collapse;"> <tr><td>P1</td><td>P2</td></tr> </table>		P1	P2																
P1	P2																																																																						
P1	P2																																																																						
P1	P2																																																																						
P1	P2																																																																						
P1	P2																																																																						
P1	P2																																																																						
P1	P2																																																																						
P1	P2																																																																						
P1	P2																																																																						
P1	P2																																																																						
P1	P2																																																																						
P1	P2																																																																						
P1	P2																																																																						
P1	P2																																																																						
1 GER <table border="1" style="display: inline-table; font-size: 8px; border-collapse: collapse;"> <tr><td>P1</td><td>P2</td></tr> </table>		P1	P2	6 RUS <table border="1" style="display: inline-table; font-size: 8px; border-collapse: collapse;"> <tr><td>P1</td><td>P2</td></tr> </table>		P1	P2	7 SWE <table border="1" style="display: inline-table; font-size: 8px; border-collapse: collapse;"> <tr><td>P1</td><td>P2</td></tr> </table>		P1	P2	8 CHN <table border="1" style="display: inline-table; font-size: 8px; border-collapse: collapse;"> <tr><td>P1</td><td>P2</td></tr> </table>		P1	P2	11 HUN <table border="1" style="display: inline-table; font-size: 8px; border-collapse: collapse;"> <tr><td>P1</td><td>P2</td></tr> </table>		P1	P2	11 HUN <table border="1" style="display: inline-table; font-size: 8px; border-collapse: collapse;"> <tr><td>P1</td><td>P2</td></tr> </table>		P1	P2	13 HUN <table border="1" style="display: inline-table; font-size: 8px; border-collapse: collapse;"> <tr><td>P1</td><td>P2</td></tr> </table>		P1	P2	13 HUN <table border="1" style="display: inline-table; font-size: 8px; border-collapse: collapse;"> <tr><td>P1</td><td>P2</td></tr> </table>		P1	P2	13 HUN <table border="1" style="display: inline-table; font-size: 8px; border-collapse: collapse;"> <tr><td>P1</td><td>P2</td></tr> </table>		P1	P2	13 HUN <table border="1" style="display: inline-table; font-size: 8px; border-collapse: collapse;"> <tr><td>P1</td><td>P2</td></tr> </table>		P1	P2	13 HUN <table border="1" style="display: inline-table; font-size: 8px; border-collapse: collapse;"> <tr><td>P1</td><td>P2</td></tr> </table>		P1	P2	13 HUN <table border="1" style="display: inline-table; font-size: 8px; border-collapse: collapse;"> <tr><td>P1</td><td>P2</td></tr> </table>		P1	P2	13 HUN <table border="1" style="display: inline-table; font-size: 8px; border-collapse: collapse;"> <tr><td>P1</td><td>P2</td></tr> </table>		P1	P2																				
P1	P2																																																																						
P1	P2																																																																						
P1	P2																																																																						
P1	P2																																																																						
P1	P2																																																																						
P1	P2																																																																						
P1	P2																																																																						
P1	P2																																																																						
P1	P2																																																																						
P1	P2																																																																						
P1	P2																																																																						
P1	P2																																																																						
P1	P2																																																																						
1 GER <table border="1" style="display: inline-table; font-size: 8px; border-collapse: collapse;"> <tr><td>P1</td><td>P2</td></tr> </table>		P1	P2	13 HUN <table border="1" style="display: inline-table; font-size: 8px; border-collapse: collapse;"> <tr><td>P1</td><td>P2</td></tr> </table>		P1	P2																																																																
P1	P2																																																																						
P1	P2																																																																						
				13 Tomas Lorincz (HUN)																																																																			

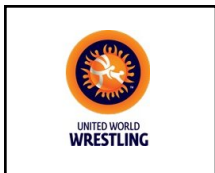

Feuille de compétition / Competition Sheet

LVIII Memoriał Władysława Pytłasińskiego/Poland OPEN



Style: null

GR71

"REPECHAGE"

"UPPER BRANCH"

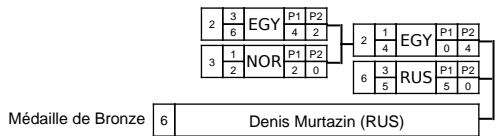

"LOWER BRANCH"

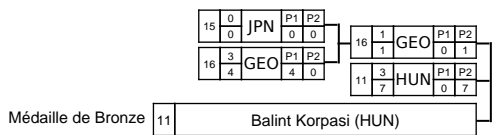

Classement		
Cl	Pays	Nom
1	HUN	Tomas Lorincz (HUN)
2	GER	Matthias Maasch (GER)
3	HUN	Balint Korpasi (HUN)
3	RUS	Denis Murtazin (RUS)
5	GEO	Manuchar Tskhadaia (GEO)
5	EGY	Ibrahim M. Hamed Ghanem (EGY)
7	CHN	Ridong Zhang (CHN)
8	TUR	Yunus Ozel (TUR)
9	NOR	Petter Karlsen (NOR)
10	SVK	Jakus Vojtech (SVK)
11	JPN	Kazuhiro Hanayama (JPN)
12	SWE	Zakarias Tallroth (SWE)
13	UKR	Bohdan Kabyn (UKR)
14	RUS	Ilya Glazkov (RUS)
15	POL	Przemysław Kraczkowski (POL)
16	POL	Edgar Melkumov (POL)
17	CZE	Filip Dubsky (CZE)
18	BLR	Ihar Drazdovich (BLR)
19	BUL	Svilen Kostadinov (BUL)



Feuille de compétition / Competition Sheet

LVIII Memoriał Władysława Pytłasińskiego/Poland OPEN



Style: null GR75

1/16 FINALE		1/8 FINALE		1/4 FINALE		1/2 FINALE		FINALE		WINNER	
1	$\frac{1}{3}$	Petr Novak (CZE)	$\frac{P1}{2} \frac{P2}{1}$	2	$\frac{1}{2}$	POL	$\frac{P1}{2} \frac{P2}{0}$	3	$\frac{0}{0}$	BUL	$\frac{P1}{0} \frac{P2}{0}$
2	$\frac{3}{4}$	Edgar Babayan (POL)	$\frac{P1}{0} \frac{P2}{4}$	3	$\frac{3}{6}$	BUL	$\frac{P1}{1} \frac{P2}{5}$	7	$\frac{3}{2}$	CRO	$\frac{P1}{0} \frac{P2}{2}$
3	$\frac{3}{2}$	Yavor Yanakiev (BUL)	$\frac{P1}{0} \frac{P2}{2}$	6	$\frac{1}{1}$	RUS	$\frac{P1}{1} \frac{P2}{0}$	7	$\frac{5}{0}$	CRO	$\frac{P1}{0} \frac{P2}{0}$
4	$\frac{0}{0}$	Damian Hartmann (GER)	$\frac{P1}{0} \frac{P2}{0}$	7	$\frac{3}{5}$	CRO	$\frac{P1}{3} \frac{P2}{2}$	7	$\frac{0}{0}$	CRO	$\frac{P1}{0} \frac{P2}{0}$
5	$\frac{0}{0}$	Omar K. Shehata Mohamed	$\frac{P1}{0} \frac{P2}{0}$	10	$\frac{0}{0}$	POL	$\frac{P1}{0} \frac{P2}{0}$	11	$\frac{0}{0}$	GER	$\frac{P1}{0} \frac{P2}{0}$
6	$\frac{5}{4}$	Alexander Chekhirkin (RUS)	$\frac{P1}{4} \frac{P2}{0}$	11	$\frac{5}{7}$	GER	$\frac{P1}{7} \frac{P2}{0}$	14	$\frac{0}{0}$	TUR	$\frac{P1}{0} \frac{P2}{0}$
7	$\frac{4}{8}$	Bozo Starcevic (CRO)	$\frac{P1}{8} \frac{P2}{0}$	14	$\frac{3}{1}$	TUR	$\frac{P1}{1} \frac{P2}{0}$	14	$\frac{4}{8}$	TUR	$\frac{P1}{8} \frac{P2}{0}$
8	$\frac{0}{0}$	Petros Manouilidis (GRE)	$\frac{P1}{0} \frac{P2}{0}$	15	$\frac{0}{0}$	CHN	$\frac{P1}{0} \frac{P2}{0}$	16	$\frac{3}{4}$	CHN	$\frac{P1}{0} \frac{P2}{4}$
9	$\frac{0}{6}$	Chang Yongxiang (CHN)	$\frac{P1}{6} \frac{P2}{0}$	16	$\frac{3}{4}$	Bin Yang (CHN)	$\frac{P1}{0} \frac{P2}{4}$	17	$\frac{1}{4}$	Takehiro Kanakubo (JPN)	$\frac{P1}{4} \frac{P2}{0}$
10	$\frac{5}{5}$	Iwan Nylypiuk (POL)	$\frac{P1}{5} \frac{P2}{0}$	18	$\frac{0}{0}$	SWE	$\frac{P1}{0} \frac{P2}{0}$	18	$\frac{3}{5}$	Bogdan Kaurinnoi (SWE)	$\frac{P1}{0} \frac{P2}{5}$
11	$\frac{4}{10}$	Pascal Eisele (GER)	$\frac{P1}{10} \frac{P2}{0}$	19	$\frac{3}{2}$	RUS	$\frac{P1}{2} \frac{P2}{0}$	19	$\frac{3}{4}$	Ruslan Isakov (RUS)	$\frac{P1}{4} \frac{P2}{0}$
12	$\frac{1}{1}$	Jevgenijs Kolcous (LAT)	$\frac{P1}{1} \frac{P2}{0}$	19	$\frac{3}{2}$	RUS	$\frac{P1}{2} \frac{P2}{0}$	20	$\frac{0}{0}$	Daniab Kobonov (KGZ)	$\frac{P1}{0} \frac{P2}{0}$
13	$\frac{1}{4}$	Aliaksandr Dzemyanovich	$\frac{P1}{0} \frac{P2}{4}$	21	$\frac{0}{4}$	DEN	$\frac{P1}{4} \frac{P2}{0}$	21	$\frac{4}{11}$	Mark Madsen (DEN)	$\frac{P1}{11} \frac{P2}{0}$
14	$\frac{3}{5}$	Emrah Kus (TUR)	$\frac{P1}{0} \frac{P2}{5}$	24	$\frac{0}{0}$	POL	$\frac{P1}{0} \frac{P2}{0}$	22	$\frac{0}{0}$	Krzysztof Niklas (POL)	$\frac{P1}{0} \frac{P2}{0}$
15	$\frac{0}{0}$	Marad Huseinav (BLR)	$\frac{P1}{0} \frac{P2}{0}$	24	$\frac{5}{2}$	POL	$\frac{P1}{0} \frac{P2}{2}$	23	$\frac{0}{0}$	Rudik Kuliev (BLR)	$\frac{P1}{0} \frac{P2}{0}$
16	$\frac{3}{4}$	Bin Yang (CHN)	$\frac{P1}{0} \frac{P2}{4}$	25	$\frac{0}{0}$	BLR	$\frac{P1}{0} \frac{P2}{0}$	24	$\frac{4}{9}$	Arkadiusz Kułynycz (POL)	$\frac{P1}{6} \frac{P2}{3}$
17	$\frac{1}{4}$	Takehiro Kanakubo (JPN)	$\frac{P1}{4} \frac{P2}{0}$	25	$\frac{0}{0}$	BLR	$\frac{P1}{0} \frac{P2}{0}$	25	$\frac{4}{8}$	Kazbek Kilou (BLR)	$\frac{P1}{4} \frac{P2}{4}$
18	$\frac{3}{5}$	Bogdan Kaurinnoi (SWE)	$\frac{P1}{0} \frac{P2}{5}$	28	$\frac{1}{6}$	RUS	$\frac{P1}{5} \frac{P2}{1}$	26	$\frac{0}{0}$	Aliaksandr Henuveina (BLR)	$\frac{P1}{0} \frac{P2}{0}$
19	$\frac{3}{4}$	Ruslan Isakov (RUS)	$\frac{P1}{4} \frac{P2}{0}$	28	$\frac{3}{2}$	RUS	$\frac{P1}{0} \frac{P2}{2}$	27	$\frac{0}{0}$	Neven Zugaj (CRO)	$\frac{P1}{0} \frac{P2}{0}$
20	$\frac{0}{0}$	Daniab Kobonov (KGZ)	$\frac{P1}{0} \frac{P2}{0}$	30	$\frac{3}{4}$	RUS	$\frac{P1}{4} \frac{P2}{0}$	28	$\frac{3}{6}$	Ilyas Magamadov (RUS)	$\frac{P1}{6} \frac{P2}{0}$
21	$\frac{4}{11}$	Mark Madsen (DEN)	$\frac{P1}{11} \frac{P2}{0}$	30	$\frac{4}{8}$	RUS	$\frac{P1}{2} \frac{P2}{6}$	29	$\frac{0}{0}$	Florian Neumaier (GER)	$\frac{P1}{0} \frac{P2}{0}$
22	$\frac{0}{0}$	Krzysztof Niklas (POL)	$\frac{P1}{0} \frac{P2}{0}$	30	$\frac{3}{9}$	RUS	$\frac{P1}{5} \frac{P2}{4}$	30	$\frac{3}{3}$	Roman Vlasov (RUS)	$\frac{P1}{0} \frac{P2}{3}$
23	$\frac{0}{0}$	Rudik Kuliev (BLR)	$\frac{P1}{0} \frac{P2}{0}$	33	$\frac{0}{0}$	BUL	$\frac{P1}{0} \frac{P2}{0}$	31	$\frac{0}{0}$	Valeriy Palenski (BLR)	$\frac{P1}{0} \frac{P2}{0}$
24	$\frac{4}{9}$	Arkadiusz Kułynycz (POL)	$\frac{P1}{6} \frac{P2}{3}$					33	$\frac{3}{1}$	Ilian Georgiev (BUL)	$\frac{P1}{0} \frac{P2}{1}$
25	$\frac{4}{8}$	Kazbek Kilou (BLR)	$\frac{P1}{4} \frac{P2}{4}$								
26	$\frac{0}{0}$	Aliaksandr Henuveina (BLR)	$\frac{P1}{0} \frac{P2}{0}$								
27	$\frac{0}{0}$	Neven Zugaj (CRO)	$\frac{P1}{0} \frac{P2}{0}$								
28	$\frac{3}{6}$	Ilyas Magamadov (RUS)	$\frac{P1}{6} \frac{P2}{0}$								
29	$\frac{0}{0}$	Florian Neumaier (GER)	$\frac{P1}{0} \frac{P2}{0}$								
30	$\frac{3}{3}$	Roman Vlasov (RUS)	$\frac{P1}{0} \frac{P2}{3}$								
31	$\frac{0}{0}$	Valeriy Palenski (BLR)	$\frac{P1}{0} \frac{P2}{0}$								
33	$\frac{3}{1}$	Ilian Georgiev (BUL)	$\frac{P1}{0} \frac{P2}{1}$								

30 Roman Vlasov (RUS)

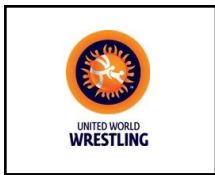

Feuille de compétition / Competition Sheet

LVIII Memoriał Władysława Pytlasińskiego/Poland OPEN



Style: null

GR75

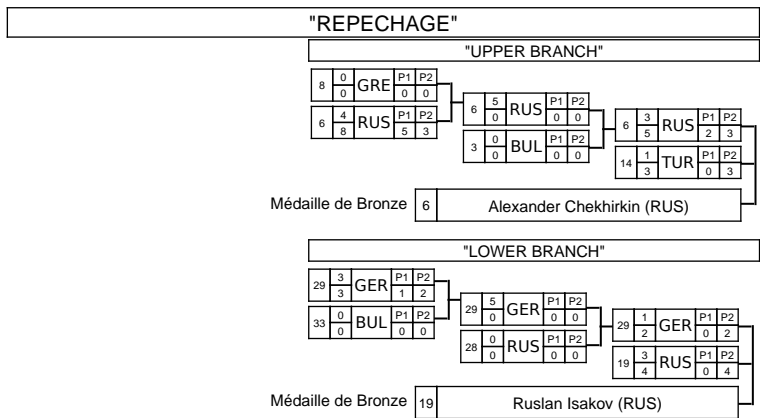

Classement		
Cl	Pays	Nom
1	RUS	Roman Vlasov (RUS)
2	CRO	Bozo Starcevic (CRO)
3	RUS	Ruslan Isakov (RUS)
3	RUS	Alexander Chekhirkin (RUS)
5	GER	Florian Neumaier (GER)
5	TUR	Emrah Kus (TUR)
7	GER	Pascal Eisele (GER)
8	POL	Arkadiusz Kułynycz (POL)
9	RUS	Ilyas Magamadov (RUS)
10	BUL	Yavor Yanakiev (BUL)
11	BUL	Ilian Georgiev (BUL)
12	POL	Iwan Nylypiuk (POL)
13	DEN	Mark Madsen (DEN)
14	BLR	Kazbek Kilou (BLR)
15	POL	Edgar Babayan (POL)
16	SWE	Bogdan Kaurinnoi (SWE)
17	CHN	Bin Yang (CHN)
18-19	BLR	Aliaksandr Dzemyanovich (BLR)
18-19	JPN	Takehiro Kanakubo (JPN)
20	POL	Jacek Tomaszewski (POL)
21	CZE	Petr Novak (CZE)
22	LAT	Jevgenijs Kolcous (LAT)
23	CHN	Chang Yongxiang (CHN)
24	BLR	Valeriy Palenski (BLR)
25	GER	Damian Hartmann (GER)
26-28	KGZ	Daniab Kobonov (KGZ)
26-28	EGY	Omar K. Shehata Mohamed (EGY)
26-28	BLR	Marad Huseinav (BLR)
29	CRO	Neven Zugaj (CRO)
30	BLR	Aliaksandr Henuveina (BLR)
31	BLR	Rudik Kuliev (BLR)
32	POL	Krzysztof Niklas (POL)
33	GRE	Petros Manouilidis (GRE)



Feuille de compétition / Competition Sheet

LVIII Memoriał Władysława Pytłasińskiego/Poland OPEN



Style: null

GR80

	QUALIFICATION	1/8 FINALE	1/4 FINALE	1/2 FINALE	FINALE	WINNER
1	Pavel Powada (CZE) P1 P2	1 1 1 CZE P1 P2 0 1	2 3 3 GEO P1 P2 0 3	2 0 0 GEO P1 P2 0 0	7 0 0 BLR P1 P2 0 0	16 Peter Bacsi (HUN)
	P1 P2					
2	Giorgi Tsirekidze (GEO) P1 P2	2 2 9 GEO P1 P2 5 4	3 1 2 RUS P1 P2 0 2	7 5 0 BLR P1 P2 0 0	16 3 3 HUN P1 P2 2 1	
	P1 P2					
3	Ramazan Abacharaev (RUS) P1 P2	3 3 3 RUS P1 P2 2 1	7 4 8 BLR P1 P2 8 0	11 0 0 TUR P1 P2 0 0	16 3 3 HUN P1 P2 2 1	
	P1 P2					
4	Julius Matuzevicius (LTU) P1 P2	4 1 2 LTU P1 P2 0 2	7 4 8 BLR P1 P2 8 0	11 5 9 TUR P1 P2 2 7	16 3 3 HUN P1 P2 3 0	
	P1 P2					
5	Zoltan Keri (HUN) P1 P2	5 1 1 HUN P1 P2 0 1	10 0 2 HUN P1 P2 2 0	16 3 3 HUN P1 P2 3 0		
	P1 P2					
6	Aisha Aishan (CHN) P1 P2	6 3 8 CHN P1 P2 2 4	10 3 4 HUN P1 P2 4 0	16 3 3 HUN P1 P2 3 0		
	P1 P2					
7	Viktar Sasunouski (BLR) P1 P2	7 5 4 BLR P1 P2 4 0	11 0 0 TUR P1 P2 0 0	16 3 3 HUN P1 P2 3 0		
	P1 P2					
8	Daniel Aleksandrov (BUL) P1 P2	8 0 0 BUL P1 P2 0 0	11 5 9 TUR P1 P2 2 7	16 3 3 HUN P1 P2 3 0		
	P1 P2					
9	Solotbok Sulaimanov (KGZ) P1 P2	9 0 0 KGZ P1 P2 0 0	14 0 0 HUN P1 P2 0 0	16 3 3 HUN P1 P2 3 0		
	P1 P2					
10	Martin Szabo (HUN) P1 P2	10 3 4 HUN P1 P2 4 0	16 3 3 HUN P1 P2 3 0			
	P1 P2					
11	Selcuk Cebi (TUR) P1 P2	11 4 8 TUR P1 P2 8 0	16 3 3 HUN P1 P2 3 0			
	P1 P2					
12	Yuya Maeta (JPN) P1 P2	12 0 0 JPN P1 P2 0 0	16 3 3 HUN P1 P2 3 0			
	P1 P2					
13	Oldrich Varga (CZE) P1 P2	13 0 0 CZE P1 P2 0 0	16 3 3 HUN P1 P2 3 0			
	P1 P2					
14	Patrik Szabo (HUN) P1 P2	14 4 8 HUN P1 P2 6 2	16 3 3 HUN P1 P2 3 0			
	P1 P2					
15	Laszlo Szabo (HUN) P1 P2 0 0	16 4 9 HUN P1 P2 4 5	16 3 3 HUN P1 P2 3 0			
	P1 P2					
16	Peter Bacsi (HUN) P1 P2 4 8	16 3 6 HUN P1 P2 0 6				
	P1 P2					
17	Aleksandr Visnakovs (LAT) P1 P2 3 4	17 1 1 LAT P1 P2 0 1				
	P1 P2					
18	Nikolaos Varkas (GRE) P1 P2 0 0					
	P1 P2					

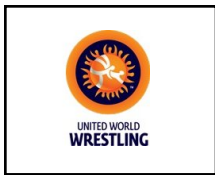

Feuille de compétition / Competition Sheet
LVIII Memoriał Władysława Pytlasińskiego/Poland OPEN



Style: null

GR80

"REPECHAGE"
"UPPER BRANCH"

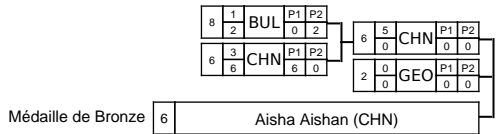

"LOWER BRANCH"

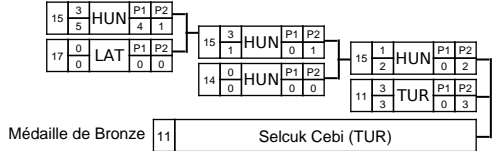

Classement		
Cl	Pays	Nom
1	HUN	Peter Bacsi (HUN)
2	BLR	Viktar Sasunouski (BLR)
3	TUR	Selcuk Cebi (TUR)
3	CHN	Aisha Aishan (CHN)
5	GEO	Giorgi Tsirekidze (GEO)
5	HUN	Laszlo Szabo (HUN)
7	HUN	Patrik Szabo (HUN)
8	RUS	Ramazan Abacharaev (RUS)
9	LAT	Aleksandr Visnakovs (LAT)
10	HUN	Martin Szabo (HUN)
11	LTU	Julius Matuzevicius (LTU)
12	BUL	Daniel Aleksandrov (BUL)
13	HUN	Zoltan Keri (HUN)
14	CZE	Pavel Powada (CZE)
15-16	KGZ	Solotbok Sulaimanov (KGZ)
15-16	GRE	Nikolaos Varkas (GRE)
17-18	JPN	Yuya Maeta (JPN)
17-18	CZE	Oldrich Varga (CZE)

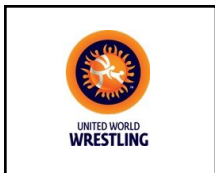

Feuille de compétition / Competition Sheet

LVIII Memoriał Władysława Pytłasińskiego/Poland OPEN



Style: null GR85

QUALIFICATION				1/16 FINALE				1/8 FINALE			
1		Kristofer Johansson (SWE)	P1 P2	1	3/6	SWE	P1 P2	1	1/3	SWE	P1 P2
			P1 P2								
2		Fabio Parisi (ITA)	P1 P2	2	1/1	ITA	P1 P2				
			P1 P2								
3		Aleksey Mishin (RUS)	P1 P2	3	4/10	RUS	P1 P2	3	3/3	RUS	P1 P2
			P1 P2								
4		Krystian Formela (POL)	P1 P2	4	1/1	POL	P1 P2				
			P1 P2								
5		Artur Omarov (CZE)	P1 P2	5	3/3	CZE	P1 P2	5	3/3	CZE	P1 P2
			P1 P2								
6		Melonin Noumonvi (FRA)	P1 P2	6	1/1	FRA	P1 P2				
			P1 P2								
7		Nenad Zugaj (CRO)	P1 P2	7	3/5	CRO	P1 P2	7	1/3	CRO	P1 P2
			P1 P2								
8		Laimutis Adomaitis (LTU)	P1 P2	8	0/0	LTU	P1 P2				
			P1 P2								
9		Javid Hamazatau (BLR)	P1 P2	9	1/3	BLR	P1 P2	10	3/5	GER	P1 P2
			P1 P2								
10		Jan Fisher (GER)	P1 P2	10	3/5	GER	P1 P2				
			P1 P2								
11		Dimitrios Tsekeridis (GRE)	P1 P2	11	1/4	GRE	P1 P2	12	1/2	EST	P1 P2
			P1 P2								
12		Alo Toom (EST)	P1 P2	12	3/6	EST	P1 P2				
			P1 P2								
13		Patryk Boniecki (POL)	P1 P2	13	4/8	POL	P1 P2	13	0/0	POL	P1 P2
			P1 P2								
14		Jesus Gasca (ESP)	P1 P2	14	0/0	ESP	P1 P2				
			P1 P2								
15		Denis Kudla (GER)	P1 P2	15	3/3	GER	P1 P2	15	4/9	GER	P1 P2
			P1 P2								
16		Damian Janikowski (POL)	P1 P2	16	1/1	POL	P1 P2				
			P1 P2								
17		Viktor Lorincz (HUN)	P1 P2	17	3/4	HUN	P1 P2	17	3/4	HUN	P1 P2
			P1 P2								
18		Roman Yusipov (RUS)	P1 P2	18	0/0	RUS	P1 P2				
			P1 P2								
19		Fei Peng (CHN)	P1 P2	19	3/5	CHN	P1 P2	19	1/2	CHN	P1 P2
			P1 P2								
20		Pedro J. Garcia (ESP)	P1 P2	20	1/4	ESP	P1 P2				
			P1 P2								
21		Mikalai Stadub (BLR)	P1 P2	21	5/4	BLR	P1 P2	21	1/1	BLR	P1 P2
			P1 P2								
22		Stanislav Kanev (BUL)	P1 P2	22	0/0	BUL	P1 P2				
			P1 P2								
23		Ramsin Azizsir (GER)	P1 P2	23	3/2	GER	P1 P2	23	3/6	GER	P1 P2
			P1 P2								
24		Taichi Oka (JPN)	P1 P2	24	0/0	JPN	P1 P2				
			P1 P2								
25		Metehan Basar (TUR)	P1 P2	25	1/12	TUR	P1 P2	26	1/2	GEO	P1 P2
			P1 P2								
26		Vladimir Gegeshidze (GEO)	P1 P2	26	3/15	GEO	P1 P2				
			P1 P2								
27		Movsar Duguchev (RUS)	P1 P2	27	3/7	RUS	P1 P2	27	3/5	RUS	P1 P2
			P1 P2								
28		Sergii Severyn (UKR)	P1 P2	28	1/2	UKR	P1 P2				
			P1 P2								
29	1/1	Eerik Aps (EST)	P1 P2	30	0/0	BUL	P1 P2	31	1/4	POL	P1 P2
			P1 P2								
30	3/3	Hristo Marinov (BUL)	P1 P2								
			P1 P2								
31	3/5	Tadeusz Michalik (POL)	P1 P2	31	3/3	POL	P1 P2				
			P1 P2								
32	1/3	Sosruko Kodzokov (RUS)	P1 P2								
			P1 P2								
33	1/1	Eugen Ponomartschuk (GER)	P1 P2	34	3/3	BLR	P1 P2	34	3/5	BLR	P1 P2
			P1 P2								
34	3/4	Aliaksandr Kikiniov (BLR)	P1 P2								
			P1 P2								
35	3/6	Rasmus Tjoerstad (NOR)	P1 P2	35	1/3	NOR	P1 P2				
			P1 P2								
36	1/4	Andrei Mikhailovski (BLR)	P1 P2								
			P1 P2								



Feuille de compétition / Competition Sheet

LVIII Memoriał Władysława Pytłasińskiego/Poland OPEN



Style: null GR85

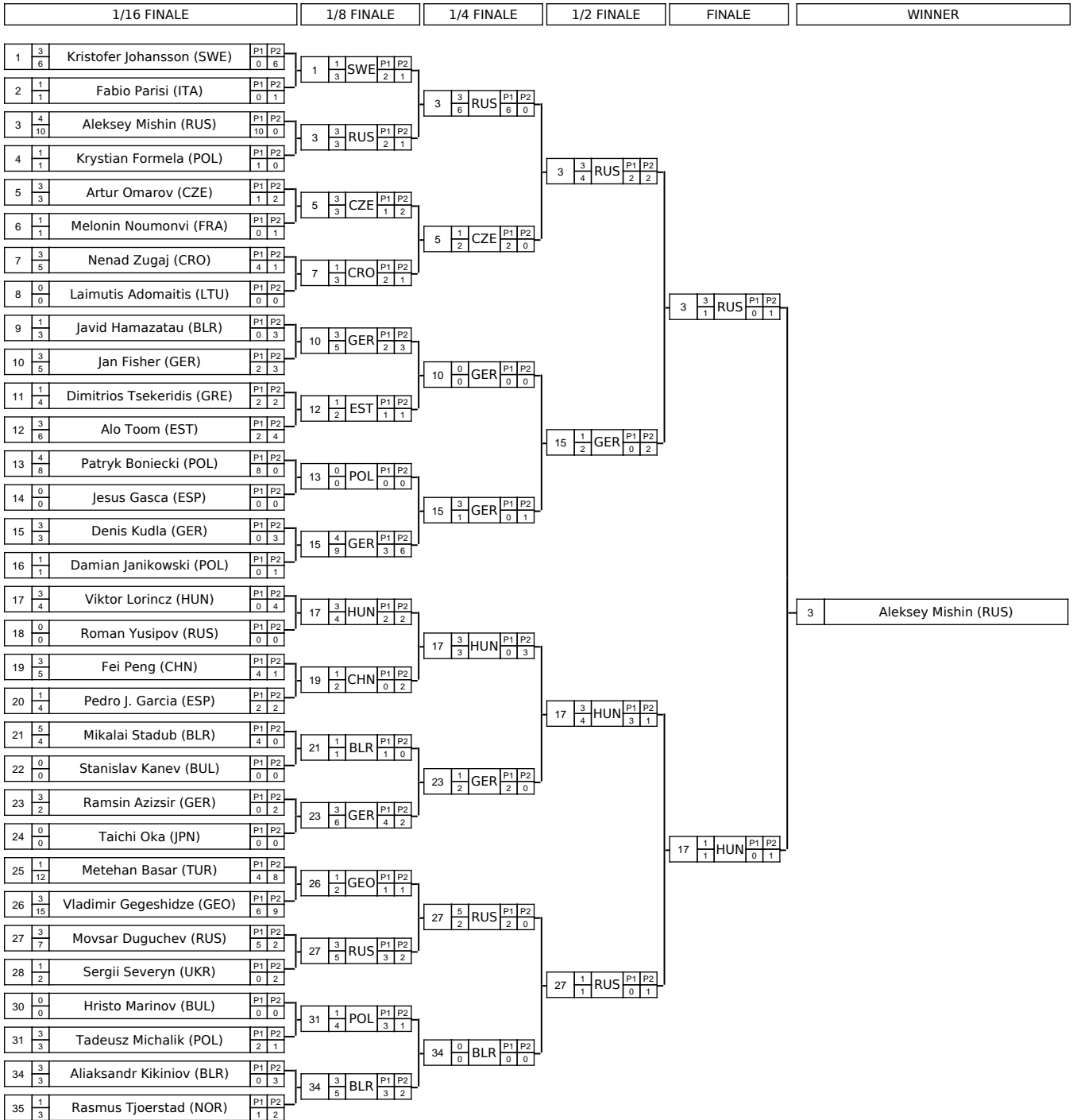



Feuille de compétition / Competition Sheet

LVIII Memoriał Władysława Pytłasińskiego/Poland OPEN



Style: null

GR85

"REPECHAGE"

"UPPER BRANCH"

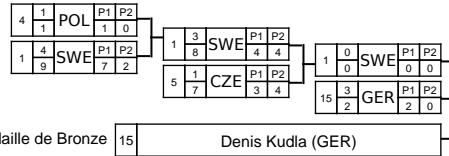

"LOWER BRANCH"

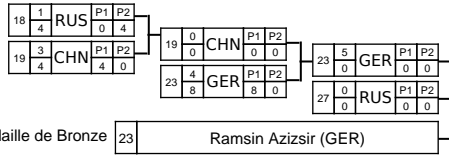

Classement

Cl	Pays	Nom
1	RUS	Aleksey Mishin (RUS)
2	HUN	Viktor Lorincz (HUN)
3	GER	Denis Kudla (GER)
3	GER	Ramsin Azizsir (GER)
5	RUS	Movsar Duguchev (RUS)
5	SWE	Kristofer Johansson (SWE)
7	BLR	Aliaksandr Kikiniou (BLR)
8	CZE	Artur Omarov (CZE)
9	POL	Tadeusz Michalik (POL)
10	CHN	Fei Peng (CHN)
11	BLR	Mikalai Stadub (BLR)
12	GER	Jan Fisher (GER)
13	POL	Patryk Boniecki (POL)
14	GEO	Vladimir Gegeshidze (GEO)
15	NOR	Rasmus Tjoerstad (NOR)
16	CRO	Nenad Zugaj (CRO)
17	EST	Alo Toom (EST)
18	BUL	Hristo Marinov (BUL)
19	POL	Krystian Formela (POL)
20	TUR	Metehan Basar (TUR)
21	ESP	Pedro J. Garcia (ESP)
22-23	GRE	Dimitrios Tsekeridis (GRE)
22-23	BLR	Andrei Mikhailovski (BLR)
24	RUS	Roman Yusipov (RUS)
25-26	RUS	Sosruko Kodzokov (RUS)
25-26	BLR	Javid Hamazatau (BLR)
27	UKR	Sergii Severyn (UKR)
28-30	EST	Eerik Aps (EST)
28-30	FRA	Melonin Noumonvi (FRA)
28-30	POL	Damian Janikowski (POL)
31	GER	Eugen Ponomartschuk (GER)
32	ITA	Fabio Parisi (ITA)
33	JPN	Taichi Oka (JPN)
34	BUL	Stanislav Kanev (BUL)
35	LTU	Laimutis Adomaitis (LTU)
36	ESP	Jesus Gasca (ESP)



Feuille de compétition / Competition Sheet

LVIII Memoriał Władysława Pytłasińskiego/Poland OPEN



Style: null GR98

1/16 FINALE			1/8 FINALE			1/4 FINALE			1/2 FINALE			FINALE			WINNER				
1	5/4	Elis Guri (BUL)	P1 P2 4 0	1	1/3	BUL	P1 P2 3 0	3	0/2	NOR	P1 P2 2 0	8	0/0	EST	P1 P2 0 0	15	5/0	IRI	P1 P2 0 0
2	0/0	Yauhen Valkhanovich (BLR)	P1 P2 0 0	3	3/7	NOR	P1 P2 2 5	8	5/3	EST	P1 P2 0 3	15	3/4	IRI	P1 P2 2 2	15	3/5	GER	P1 P2 4 1
3	5/7	Martin Nielsen (NOR)	P1 P2 4 3	5	1/1	BLR	P1 P2 0 1	15	3/3	IRI	P1 P2 1 2	20	3/4	GER	P1 P2 0 4	20	0/0	GER	P1 P2 0 0
4	0/4	Aliaksandr Hrabovik (BLR)	P1 P2 0 4	8	3/2	EST	P1 P2 0 2	20	4/8	SWE	P1 P2 0 8	27	0/0	SWE	P1 P2 0 0	33	0/0	GER	P1 P2 0 0
5	4/8	Tsimafei Dzeinchenka (BLR)	P1 P2 8 0	9	3/2	RUS	P1 P2 1 1	22	0/2	BUL	P1 P2 2 0	27	3/1	SWE	P1 P2 1 0	33	3/1	GER	P1 P2 0 1
6	0/0	Felix Radinger (GER)	P1 P2 0 0	12	0/0	TUR	P1 P2 0 0	24	1/4	NOR	P1 P2 0 4	29	0/0	Maksim Safarian (RUS)	P1 P2 0 0	33	0/0	Di Xiao (CHN)	P1 P2 0 5
7	0/0	Łukasz Konera (POL)	P1 P2 0 0	14	0/0	UKR	P1 P2 0 0	24	5/6	NOR	P1 P2 6 0	30	0/0	Marcel Kasperek (POL)	P1 P2 0 0	33	0/0	Oliver Hassler (GER)	P1 P2 8 0
8	3/7	Ardo Arusaar (EST)	P1 P2 2 5	15	4/10	IRI	P1 P2 6 4	26	1/1	LTU	P1 P2 1 0	31	0/0	Erwin Imbierski (POL)	P1 P2 0 0				
9	3/9	Musa Evloev (RUS)	P1 P2 2 7	18	1/2	IRI	P1 P2 2 0	26	4/10	Vilius Laurinaitis (LTU)	P1 P2 2 8								
10	1/6	Konstantin Efimov (RUS)	P1 P2 2 4	20	3/6	GER	P1 P2 6 0	27	4/8	SWE	P1 P2 0 8								
11	1/2	Daigoro Timoncini (ITA)	P1 P2 0 2	20	3/8	GER	P1 P2 6 0	27	0/0	SWE	P1 P2 0 0								
12	3/3	Cenk Ildem (TUR)	P1 P2 2 1	21	1/3	Ilya Nastochenko (KAZ)	P1 P2 2 1	27	0/0	SWE	P1 P2 0 0								
13	1/3	Evgeni Genchev (BUL)	P1 P2 0 3	22	3/3	Vladislav Metodiev (BUL)	P1 P2 0 3	29	0/0	Maksim Safarian (RUS)	P1 P2 0 0								
14	3/6	Mykola Krysov (UKR)	P1 P2 2 4	24	5/4	Felix Baldauf (NOR)	P1 P2 4 0	30	3/5	Di Xiao (CHN)	P1 P2 0 5								
15	3/3	Ghasem Rezai (IRI)	P1 P2 3 0	25	1/2	Aleksander Kroczak (POL)	P1 P2 2 0	31	0/0	Marcel Kasperek (POL)	P1 P2 0 0								
16	0/0	Patrick Cawey (USA)	P1 P2 0 0	26	4/10	Vilius Laurinaitis (LTU)	P1 P2 2 8	33	4/8	Oliver Hassler (GER)	P1 P2 8 0								
17	0/0	Balazs Kiss (HUN)	P1 P2 0 0	27	4/12	Frederik Schoen (SWE)	P1 P2 6 6												
18	4/8	M. Aliyarifeizabadi (IRI)	P1 P2 8 0	28	0/0	Erwin Imbierski (POL)	P1 P2 0 0												
19	0/0	Josef Rau (USA)	P1 P2 0 0	29	0/0	Maksim Safarian (RUS)	P1 P2 0 0												
20	4/8	Peter Ohler (GER)	P1 P2 8 0	30	3/5	Di Xiao (CHN)	P1 P2 0 5												
21	1/3	Ilya Nastochenko (KAZ)	P1 P2 2 1	31	0/0	Erwin Imbierski (POL)	P1 P2 0 0												
22	3/3	Vladislav Metodiev (BUL)	P1 P2 0 3	33	4/8	Oliver Hassler (GER)	P1 P2 8 0												
23	0/0	Yasuhiro Yonehira (JPN)	P1 P2 0 0																
24	5/4	Felix Baldauf (NOR)	P1 P2 4 0																
25	1/2	Aleksander Kroczak (POL)	P1 P2 2 0																
26	4/10	Vilius Laurinaitis (LTU)	P1 P2 2 8																
27	4/12	Frederik Schoen (SWE)	P1 P2 6 6																
28	0/0	Erwin Imbierski (POL)	P1 P2 0 0																
29	0/0	Maksim Safarian (RUS)	P1 P2 0 0																
30	3/5	Di Xiao (CHN)	P1 P2 0 5																
31	0/0	Marcel Kasperek (POL)	P1 P2 0 0																
33	4/8	Oliver Hassler (GER)	P1 P2 8 0																



Feuille de compétition / Competition Sheet

LVIII Memoriał Władysława Pytłasińskiego/Poland OPEN



Style: null

GR98

"REPECHAGE"

"UPPER BRANCH"

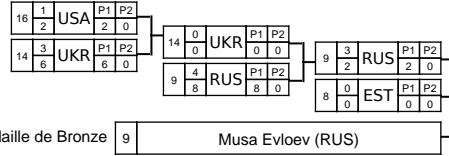

"LOWER BRANCH"

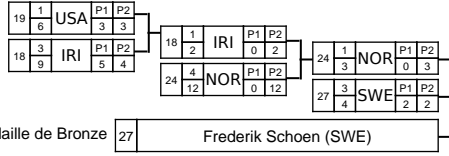

Classement

Cl	Pays	Nom
1	IRI	Ghasem Rezai (IRI)
2	GER	Peter Ohler (GER)
3	RUS	Musa Evloev (RUS)
3	SWE	Frederik Schoen (SWE)
5	EST	Ardo Arusaar (EST)
5	NOR	Felix Baldauf (NOR)
7	GER	Oliver Hassler (GER)
8	IRI	M. Aliyarifeizabadi (IRI)
9	NOR	Martin Nielsen (NOR)
10	BUL	Elis Guri (BUL)
11	UKR	Mykola Krysov (UKR)
12	LTU	Vilius Laurinaitis (LTU)
13	BLR	Tsimafei Dzeinchenka (BLR)
14	CHN	Di Xiao (CHN)
15	BUL	Vladislav Metodiev (BUL)
16	TUR	Genk Ildem (TUR)
17	RUS	Konstantin Efimov (RUS)
18	USA	Josef Rau (USA)
19	KAZ	Ilya Nastochenko (KAZ)
20	BUL	Evgeni Genchev (BUL)
21	ITA	Daigoro Timoncini (ITA)
22	USA	Patrick Cawey (USA)
23	POL	Aleksander Kroczak (POL)
24	POL	Radosław Grzybicki (POL)
25	BLR	Aliaksandr Hrabovik (BLR)
26-27	BLR	Yauhen Valkhanovich (BLR)
26-27	JPN	Yasuhiro Yonehira (JPN)
28	RUS	Maksim Safarian (RUS)
29	POL	Łukasz Konera (POL)
30-32	HUN	Balazs Kiss (HUN)
30-32	GER	Felix Radinger (GER)
30-32	POL	Marcel Kasperek (POL)
33	POL	Erwin Imbierski (POL)

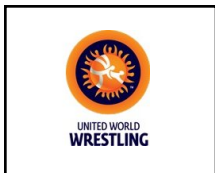

Feuille de compétition / Competition Sheet

LVIII Memoriał Władysława Pytłasińskiego/Poland OPEN



Style: null

GR130

QUALIFICATION	1/4 FINALE	1/2 FINALE	FINALE	WINNER
---------------	------------	------------	--------	--------



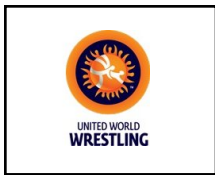

Feuille de compétition / Competition Sheet
LVIII Memoriał Władysława Pytlasińskiego/Poland OPEN



Style: null

GR130

"REPECHAGE"
"UPPER BRANCH"

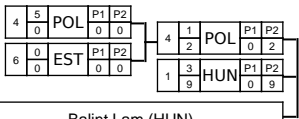

Médaille de Bronze 1 Balint Lam (HUN)

"LOWER BRANCH"

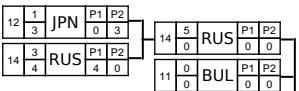

Médaille de Bronze 14 Vitalii Shchur (RUS)

Classement		
Cl	Pays	Nom
1	CHN	Qiang Meng (CHN)
2	GER	Christian John (GER)
3	RUS	Vitalii Shchur (RUS)
3	HUN	Balint Lam (HUN)
5	POL	Łukasz Banak (POL)
5	BUL	Lyubomir Dimitrov (BUL)
7	EGY	Abdellotef M. Ahmed Abd (EGY)
8	EST	Heiki Nabi (EST)
9	IRI	Mahdi Nouri (IRI)
10	JPN	Arata Sonoda (JPN)
11	IRI	Shahab Chourehjili (IRI)
12	POL	Rafal Płowiec (POL)
13-15	LTU	Mizgatis Mindaugas (LTU)
13-15	LTU	Mantas Knystautas (LTU)
13-15	GER	Eduard Popp (GER)



XXIV INTERNATIONAL TOURNAMENT ZIÓLKOWSKI



FREE STYLE

WARSAW 23-24.07.2015

KLASYFIKACJA DRUŻYNOWA													
Miejsce	Klub (Miejscowość)	Liczba zawodników	57 KG	61 KG	65 KG	70 KG	74 KG	86 KG	97 KG	125 KG	TOTAL		
1	<u>TURKEY (TUR)</u>	12		19 /4		17 /2	0 /1	18 /2	6 /3		60		
2	<u>RUSSIA (RUS)</u>	9	9 /1		8 /1	24 /3	2 /2			9 /2	52		
3	<u>JAPAN (JPN)</u>	5	10 /1	9 /1	8 /1		9 /1		4 /1		40		
4	<u>GERMANY (GER)</u>	10	6 /1		1 /2	0 /1	14 /2	4 /1	4 /2	8 /1	37		
5	<u>IRAN (IRI)</u>	5					18 /3		18 /2		36		
6	<u>BULGARIA (BUL)</u>	5	8 /1	16 /2			6 /1	3 /1			33		
7	<u>POLAND (POL)</u>	26	2 /4	0 /1	2 /1	0 /5	1 /4	16 /6	8 /2	2 /3	31		
8	<u>GEORGIA (GEO)</u>	6		8 /1		3 /1		0 /2	9 /1	10 /1	30		
9	<u>BELARUS (BLR)</u>	12	0 /1	4 /1	0 /1	6 /2		8 /3	0 /3	9 /1	27		
10	<u>UKRAINE (UKR)</u>	7	4 /1		6 /2	6 /2		0 /1	2 /1		18		
11-12	<u>FRANCE (FRA)</u>	4	8 /1		3 /1		3 /1	2 /1			16		
11-12	<u>CHINA (CHN)</u>	7			6 /2		0 /1	0 /1	0 /1	9 /2	15		
13	<u>SPAIN (ESP)</u>	5	9 /2				0 /1		0 /1	4 /1	13		
14	<u>SLOVAKIA (SVK)</u>	7			4 /1	1 /1	0 /1	6 /3	0 /1		11		
15-16	<u>ITALY (ITA)</u>	2			10 /1			0 /1			10		
15-16	<u>ROMANIA (ROU)</u>	2	0 /1		9 /1						9		
17-18	<u>KYRGYZSTAN (KGZ)</u>	1							6 /1		6		
17-18	<u>EGYPT (EGY)</u>	3		0 /1					0 /1	6 /1	6		
19	<u>HUNGARY (HUN)</u>	6				0 /1	4 /3	0 /1		0 /1	4		
20-21	<u>CANADA (CAN)</u>	1		1 /1							1		
20-21	<u>ESTONIA (EST)</u>	2	1 /1						0 /1		1		
22-26	<u>CZECH REPUBLIC (CZE)</u>	2					0 /1	0 /1			0		
22-26	<u>LATVIA (LAT)</u>	3					0 /1	0 /1	0 /1		0		
22-26	<u>AFGHANISTAN (AFG)</u>	3				0 /3					0		
22-26	<u>AUSTRIA (AUT)</u>	3			0 /1	0 /1	0 /1				0		
22-26	<u>LITHUANIA (LTU)</u>	1					0 /1				0		
TOTAL:		149											



XXIV INTERNATIONAL TOURNAMENT ZIÓLKOWSKI

FREE STYLE

WARSAW 23-24.07.2015



Klasyfikacja indywidualna kat: 57 kg

P	NAME & SURNAME	CLUB	YEAR	POINTS	TOUCH-FALL	SUPERIORITY:	points	LOST
1	Yuki Takahashi	JAPAN (JPN)		14	0	2	33	1
2	Azamat Tuskaev	RUSSIA (RUS)	1980	10	0	0	12	5
3	Z. El-Ouarraque	FRANCE (FRA)	1984	7	0	0	9	6
3	Georgi Vangelov	BULGARIA (BUL)	1993	9	0	0	13	14
5	Emanuel Krause	GERMANY (GER)	1984	3	0	0	7	11
5	Juan Pablo Gonzalez	SPAIN (ESP)	1980	4	0	0	11	17
7	Petro Bilevchuk	UKRAINE (UKR)	1994	5	0	1	14	11
8	Metreveli Levan	SPAIN (ESP)	1980	4	0	0	10	5
9	Krzysztof Bienkowski	POLAND (POL)	1990	4	0	0	3	5
10	Aleksiej Basakov	ESTONIA (EST)	1980	3	0	0	11	26
11	Patrik Olenczyn	POLAND (POL)	1997	1	0	0	8	11
12	Ivan Guidea	ROMANIA (ROU)	1988	1	0	0	3	5
13	Dimchik Rinchinov	BELARUS (BLR)	1990	1	0	0	2	8
14	Adrian Hajduk	POLAND (POL)	1989	1	0	0	1	2
15	Dawid Romanowicz	POLAND (POL)	1994	0	0	0	0	10

Klasyfikacja indywidualna kat: 61 kg

P	NAME & SURNAME	CLUB	YEAR	POINTS	TOUCH-FALL	SUPERIORITY:	points	LOST
1	Vladimir Dubov	BULGARIA (BUL)	1988	13	0	1	40	19
2	Masdram Kamoj	JAPAN (JPN)		7	0	0	20	15
3	Beka Lomladze	GEORGIA (GEO)	1985	4	0	0	16	11
3	Munir Recep Aktas	TURKEY (TUR)	1984	10	0	0	11	18
5	Recep Topal	TURKEY (TUR)	1980	9	0	1	27	16
5	Radoslav Velikov	BULGARIA (BUL)	1980	5	0	0	9	17
7	Uladzislau Andreyeu	BELARUS (BLR)	1980	4	0	0	11	2
8	Mustafa Kartal	TURKEY (TUR)	1980	2	0	0	5	15
9	Sezar Akqul	TURKEY (TUR)	1986	1	0	0	1	3
10	Michael Asselstine	CANADA (CAN)	1990	1	0	0	1	6
11	Ibrahim Abdelhamid	EGYPT (EGY)		0	0	0	0	9
12	Tomasz Ogonowski	POLAND (POL)	1994	0	0	0	0	10

Klasyfikacja indywidualna kat: 65 kg

P	NAME & SURNAME	CLUB	YEAR	POINTS	TOUCH-FALL	SUPERIORITY:	points	LOST
1	Marquez Frank Chamizo	ITALY (ITA)	1980	13	0	1	28	12
2	George Bucur	ROMANIA (ROU)	1986	10	0	0	28	16
3	Tomotsugu Ishida	JAPAN (JPN)		7	0	0	7	7
3	Soslan Ramonov	RUSSIA (RUS)	1980	9	0	2	24	4
5	Andriy Kyvatkovskyy	UKRAINE (UKR)	1984	7	0	0	12	21
5	Haiwei Ling	CHINA (CHN)	1980	5	0	0	22	23
7	Mvkola Bolotniuk	SLOVAKIA (SVK)	1989	6	0	1	21	21
8	Christof Clavier	FRANCE (FRA)	1980	4	0	1	12	8
9	Rashid Mostoi	POLAND (POL)	1996	4	0	0	9	23
10	Kevin Henkel	GERMANY (GER)	1994	4	0	0	8	8
11	Ivan Petriv	UKRAINE (UKR)		1	0	0	6	7
12	Katai Yeerianbieke	CHINA (CHN)		1	0	0	4	14
13	Samet Dulger	GERMANY (GER)	1980	1	0	0	2	2
14	Viktar Serada	BELARUS (BLR)	1984	1	0	0	2	12
15	M. Avsserleitner	AUSTRIA (AUT)	1996	0	0	0	0	7

Klasyfikacja indywidualna kat: 70 kg

P	NAME & SURNAME	CLUB	YEAR	POINTS	TOUCH-FALL	SUPERIORITY:	points	LOST
1	K. Tcabolov	RUSSIA (RUS)		20	2	1	32	12
2	Yakup Gor	TURKEY (TUR)	1986	13	0	3	38	10
3	Mustaffa Kaya	TURKEY (TUR)	1992	15	1	1	34	18
3	German Ustinov	RUSSIA (RUS)	1984	13	1	1	22	20
5	Sharap Gitinov	RUSSIA (RUS)	1980	9	0	1	23	17
5	Oleksiy Melnyk	UKRAINE (UKR)	1980	9	0	1	32	31
7	Nurikov Azamat	BELARUS (BLR)		7	0	1	20	8
8	Davit Tlashadze	GEORGIA (GEO)	1991	5	0	1	16	8
9	Zhan Safian	BELARUS (BLR)	1985	5	0	1	15	9
10	Robert Olle	SLOVAKIA (SVK)		5	0	1	15	14
11	Pawel Albinowski	POLAND (POL)	1991	4	0	1	10	21
12	Lennard Wickel	GERMANY (GER)	1986	4	0	0	11	13
13	Philipp Crepaz	AUSTRIA (AUT)	1986	1	0	0	4	7
14	Damian Falat	POLAND (POL)	1994	1	0	0	2	12
15	B. Lagzi Kovacs	HUNGARY (HUN)		1	0	0	2	13
16	Arkadiusz Szeja	POLAND (POL)	1992	0	0	0	0	3
17-22	Mateusz Kampik	POLAND (POL)	1996	0	0	0	0	10
17-22	Marcin Majka	POLAND (POL)	1996	0	0	0	0	10
17-22	Mobin Hakimi	AFGHANISTAN (AFG)		0	0	0	0	10
17-22	Mostafa Nasari	AFGHANISTAN (AFG)		0	0	0	0	10
17-22	Oleksii Domanyskiy	UKRAINE (UKR)		0	0	0	0	10
17-22	Mehdi Nasari	AFGHANISTAN (AFG)		0	0	0	0	10



XXIV INTERNATIONAL TOURNAMENT ZIÓLKOWSKI

FREE STYLE

WARSAW 23-24.07.2015



Klasyfikacja indywidualna kat: 74 kg

P	NAME & SURNAME	CLUB	YEAR	POINTS	TOUCH-FALL	SUPERIORITY:	points	LOST
1	Alireza Ghasemi	IRAN (IRI)	1980	15	1	1	28	0
2	Sohsuke Takanaki	JAPAN (JPN)		16	0	4	44	8
3	Razaei Ghaleh Morteza	IRAN (IRI)		14	0	1	30	21
3	Georg Harth	GERMANY (GER)	1986	9	0	0	18	18
5	Miroslav Kirov	BULGARIA (BUL)	1980	6	1	0	2	11
5	Martin Obst	GERMANY (GER)	1980	10	0	0	14	25
7	Mihaly Nagy	HUNGARY (HUN)	1996	9	1	1	25	22
8	Zelimkhan Khadijev	FRANCE (FRA)	1996	9	1	0	13	11
9	Nikita Suchkov	RUSSIA (RUS)	1996	9	0	2	32	12
10	Krzystian Brzozowski	POLAND (POL)	1982	5	0	1	14	5
11	P. Yarahmadi	IRAN (IRI)	1990	5	0	1	12	4
12	Amirkhan Visalimov	AUSTRIA (AUT)		4	0	1	12	10
13	S. Khachirov	RUSSIA (RUS)		4	0	0	11	12
14	Chongyao Zhang	CHINA (CHN)	1990	1	0	0	3	6
15	Andrius Mazeika	LITHUANIA (LTU)	1994	1	0	0	3	13
16	Soner Demitras	TURKEY (TUR)	1980	1	0	0	2	2
17	Andrzej Sokalski	POLAND (POL)	1990	1	0	0	2	7
18	G. Baghdasarian	CZECH REPUBLIC (CZE)	1984	1	0	0	2	12
19	Peter Nagy	HUNGARY (HUN)	1995	1	0	0	2	13
20	Navarro Alberto Martinez	SPAIN (ESP)	1990	1	0	0	1	22
21	Alberts Jurcenko	LATVIA (LAT)	1997	0	0	0	5	4
22	Kamil Rybicki	POLAND (POL)	1996	0	0	0	0	5
23	Dan Palinkas	SLOVAKIA (SVK)	1984	0	0	0	0	9
24	Damian Woźniak	POLAND (POL)	1996	0	0	0	0	10
25	Richard Ligeti	HUNGARY (HUN)	1994	0	0	0	0	13

Klasyfikacja indywidualna kat: 86 kg

P	NAME & SURNAME	CLUB	YEAR	POINTS	TOUCH-FALL	SUPERIORITY:	points	LOST
1	Selim Yasar	TURKEY (TUR)	2000	17	0	2	46	6
2	Radosław Marcinkiewicz	POLAND (POL)	1986	14	0	1	24	13
3	Ahmet Bilici	TURKEY (TUR)	1980	13	0	0	40	27
3	Amarhajv Mahamedau	BELARUS (BLR)	1984	12	0	2	28	7
5	Rene Matejov	SLOVAKIA (SVK)	1987	8	0	1	21	24
5	Sebastian Jezierzański	POLAND (POL)	1991	11	0	0	24	24
7	William Harth	GERMANY (GER)	1986	9	0	1	23	14
8	Mihail Ganey	BULGARIA (BUL)	1980	7	0	0	12	9
9	Akhmed Aibuev	FRANCE (FRA)	1991	5	0	1	12	2
10	Zbigniew Baranowski	POLAND (POL)	1991	4	0	0	12	11
11	Jumber Kvelashvili	GEORGIA (GEO)	1992	4	0	0	8	11
12	Michael Bodnar	SLOVAKIA (SVK)	1993	4	0	0	4	18
13	Siriqueleng Siriqueleng	CHINA (CHN)		3	0	0	14	10
14	Lilia Archaja	UKRAINE (UKR)	0	1	0	0	8	14
15	Sandro Aminashvili	GEORGIA (GEO)	1992	1	0	0	6	14
16	Aliaksandr Hushtyn	BELARUS (BLR)	1996	1	0	0	4	6
17	Patrik Dublinowski	POLAND (POL)	1992	1	0	0	3	4
18	Yauhen Aliashkevich	BELARUS (BLR)	1984	1	0	0	2	4
19	Thomas Redento	SLOVAKIA (SVK)	1991	1	0	0	2	12
20	Armands Zvirbulis	LATVIA (LAT)	1987	1	0	0	1	4
21	Vratislav Chotas	CZECH REPUBLIC (CZE)	1986	1	0	0	1	13
22	Gergely Gyurits	HUNGARY (HUN)	1990	0	0	0	0	6
23	Michał Szymański	POLAND (POL)	1996	0	0	0	0	10
24	Krzysztof Sadowik	POLAND (POL)	1996	0	0	0	0	12
25	Aron Caneva	ITALY (ITA)	1995	0	0	0	0	20

Klasyfikacja indywidualna kat: 97 kg

P	NAME & SURNAME	CLUB	YEAR	POINTS	TOUCH-FALL	SUPERIORITY:	points	LOST
1	Tahan Abbas	IRAN (IRI)		12	0	0	26	13
2	Elizbar Odikadze	GEORGIA (GEO)	1989	15	1	0	22	9
3	Mohammadhossein	IRAN (IRI)	1990	18	1	1	23	6
3	Radosław Baran	POLAND (POL)	1989	12	0	0	24	16
5	Alexey Krupnyakov	KYRGYZSTAN (KGZ)	1986	8	0	1	25	14
5	Ibrahim Bolukbasi	TURKEY (TUR)	1980	14	2	0	18	15
7	Tolaski Yamaguchi	JAPAN (JPN)		9	1	0	10	19
8	Stefan Kehrer	GERMANY (GER)	1980	4	0	1	12	5
9	Hleb Kutev	UKRAINE (UKR)		4	0	0	9	13
10	Gennadij Cudinovic	GERMANY (GER)	1994	3	0	0	9	9
11	Ivan Yankovski	BELARUS (BLR)	1980	3	0	0	8	6
12	Can Zeybek Yusuf	TURKEY (TUR)	1992	2	0	0	8	18
13	Ibrahim Saidau	BELARUS (BLR)	1985	1	0	0	6	8
14	Yusup Dzalievov	BELARUS (BLR)		1	0	0	6	10
15	Maciej Balawender	POLAND (POL)	1988	1	0	0	4	4
16	Legoaskis Imantas	LATVIA (LAT)	1980	1	0	0	3	5
17	Jozef Jaloviar	SLOVAKIA (SVK)	1990	1	0	0	2	3
18	Riza Yildirim	TURKEY (TUR)	1980	0	0	0	6	12
19	Aly Hamdy Amin Rabei	EGYPT (EGY)		0	0	0	0	5
20-21	Xueyi Zhang	CHINA (CHN)	1986	0	0	0	0	10
20-21	Raagnar Kaasik	ESTONIA (EST)	1988	0	0	0	0	10
22	Hector Rodriguez Iglesias	SPAIN (ESP)	1980	0	0	0	0	11

Klasyfikacja indywidualna kat: 125 kg

P	NAME & SURNAME	CLUB	YEAR	POINTS	TOUCH-FALL	SUPERIORITY:	points	LOST
1	Geno Petriashvili	GEORGIA (GEO)	1994	14	1	0	27	7
2	Aleksiej Nikolaev	BELARUS (BLR)	1990	7	0	1	18	13
3	Zhiwei Deng	CHINA (CHN)	1990	14	0	2	25	11
3	Nick Matuhin	GERMANY (GER)	1990	12	0	2	39	16
5	Muradin Kushkhov	RUSSIA (RUS)	2000	8	0	2	22	2
5	Khaled Omr Mohamed	EGYPT (EGY)		0	0	0	0	20
7	Jose Cuba	SPAIN (ESP)	1981	5	1	0	4	10
8	Eduar Bazrov	RUSSIA (RUS)	1980	1	0	0	8	12
9	Karol Turczyński	POLAND (POL)	1997	1	0	0	2	19
10	Hai Shang	CHINA (CHN)	2000	1	0	0	1	12
11	Kamil Kościółek	POLAND (POL)	1996	0	0	0	0	4
12-13	Robert Baran	POLAND (POL)	1992	0	0	0	0	10
12-13	Mihaly Nagy	HUNGARY (HUN)	1995	0	0	0	0	10

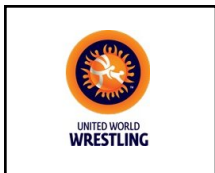

Feuille de compétition / Competition Sheet

XXIV Memoriał Wacława Ziółkowskiego



Style: FS

57





Feuille de compétition / Competition Sheet

XXIV Memoriał Wacława Ziółkowskiego



Style: FS

57

"REPECHAGE"

"UPPER BRANCH"

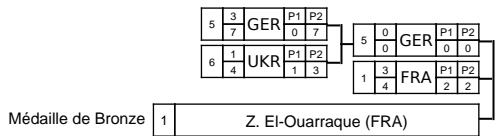

"LOWER BRANCH"

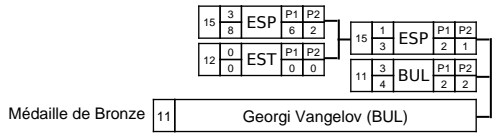

Classement		
Cl	Pays	Nom
1	JPN	Jurlei Takahashi (JPN)
2	RUS	Azamat Tuskaev (RUS)
3	FRA	Z. El-Ouarraque (FRA)
3	BUL	Georgi Vangelov (BUL)
5	GER	Emanuel Krause (GER)
5	ESP	Juan Pablo Gonzalez (ESP)
7	UKR	Petro Bileychuk (UKR)
8	ESP	Metreveli Levan (ESP)
9	POL	Krzysztof Bieńkowski (POL)
10	EST	Aleksei Basakov (EST)
11	POL	Patryk Otenczyn (POL)
12	ROU	Ivan Guidea (ROU)
13	BLR	Dimchik Rinchinov (BLR)
14	POL	Adrian Hajduk (POL)
15	POL	Dawid Romanowicz (POL)



Feuille de compétition / Competition Sheet

XXIV Memoriał Wacława Ziółkowskiego

Style: FS

61



QUALIFICATION	1/4 FINALE	1/2 FINALE	FINALE	WINNER
---------------	------------	------------	--------	--------





Feuille de compétition / Competition Sheet

XXIV Memoriał Wacława Ziółkowskiego

Style: FS

61



"REPECHAGE"

"UPPER BRANCH"

3	3	GEO	P1	P2
	9		3	4
2	1	BUL	P1	P2
	1		0	1

Médaille de Bronze 3 Beka Lomtadze (GEO)

"LOWER BRANCH"

8	1	TUR	P1	P2
	3		1	2
5	3	TUR	P1	P2
	6		0	6
11	3	TUR	P1	P2
	2		1	1

Médaille de Bronze 11 Munir Recep Aktas (TUR)

Classement

Cl	Pays	Nom
1	BUL	Vladimir Dubov (BUL)
2	JPN	MasDRAM Kamoi (JPN)
3	GEO	Beka Lomtadze (GEO)
3	TUR	Munir Recep Aktas (TUR)
5	TUR	Recep Topal (TUR)
5	BUL	Radoslav Velikov (BUL)
7	BLR	Uladzislau Andreyeu (BLR)
8	TUR	Mustafa Kartal (TUR)
9	TUR	Sezar Akgul (TUR)
10	CAN	Michael Asselstine (CAN)
11	EGY	Ibrahim Abdelhamid (EGY)
12	POL	Tomasz Ogonowski (POL)



Feuille de compétition / Competition Sheet
XXIV Memoriał Wacława Ziółkowskiego



Style: FS

65

"REPECHAGE"
"UPPER BRANCH"

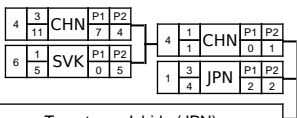

Médaille de Bronze 1 Tomotsugu Ishida (JPN)

"LOWER BRANCH"

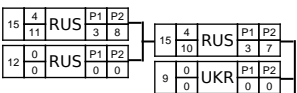

Médaille de Bronze 15 Soslan Ramonov (RUS)

Classement		
Cl	Pays	Nom
1	ITA	Marquez Frank Chamizo (ITA)
2	ROU	George Bucur (ROU)
3	RUS	Soslan Ramonov (RUS)
3	JPN	Tomotsugu Ishida (JPN)
5	CHN	Haiwei Ling (CHN)
5	UKR	Andriy Kvyatkovskyy, (UKR)
7	SVK	Mykola Bolotnjuk (SVK)
8	FRA	Christof Clavier (FRA)
9	RUS	Rashid Mostoi (RUS)
10	GER	Kevin Henkel (GER)
11	UKR	Ivan Petriv (UKR)
12	CHN	Katai Yeerianbieke (CHN)
13	GER	Samet Dulger (GER)
14	BLR	Viktar Serada (BLR)
15	AUT	M. Avsserleitner (AUT)



Feuille de compétition / Competition Sheet

XXIV Memoriał Wacława Ziółkowskiego

Style: FS

70



QUALIFICATION		1/8 FINALE	1/4 FINALE	1/2 FINALE	FINALE	WINNER
1	Marcin Majka (POL)	1 0 0	1 0 0	2 1 2	4 4 13	12 K. Tcabolov (RUS)
2	German Ustinov (RUS)	2 4 10	2 4 10	2 1 2	4 4 13	
3	Mobin Hakimi (AFG)	3 0 0	3 0 0	4 4 13	4 1 2	
4	Yakup Gor (TUR)	4 4 10	4 4 10	4 4 13	4 1 2	
5	Oleksiy Melnyk (UKR)	5 4 10	5 4 10	5 1 2	4 1 2	
6	Mehdi Nasari (GER)	6 0 0	6 0 0	5 1 2	4 1 2	
7	Lennard Wickel (GER)	7 3 3	7 3 3	5 1 2	4 1 2	
8	Arkadiusz Szeja (POL)	8 0 0	8 0 0	7 1 8	4 1 2	
9	Mateusz Kampik (POL)	9 0 0	9 0 0	7 1 8	4 1 2	
10	Sharap Gitinov (RUS)	10 4 10	10 4 10	7 1 8	4 1 2	
11	Zhan Safian (BLR)	11 0 0	11 0 0	10 1 4	12 5 4	
12	K. Tcabolov (RUS)	12 5 4	12 5 4	10 1 4	12 5 4	
13	Mostafa Nasari (GER)	13 0 0	13 0 0	12 3 8	12 5 4	
14	Paweł Albinowski (POL)	14 4 10	14 4 10	12 3 8	12 5 4	
15	Robert Olce (SVK)	15 4 13	15 1 2	12 3 8	12 3 6	
16	B Lagzi Kovacs (HUN)	16 1 2	16 1 2	17 5 4	12 3 6	
17	Mustaffa Kaya (TUR)	17 3 7	17 4 12	17 5 4	12 3 6	
18	Philipp Crepaz (AUT)	18 1 4	18 1 4	17 0 6	12 3 6	
19	Davit Tlashadze (GEO)	19 4 12	19 1 4	17 0 6	12 3 6	
20	Damian Falat (POL)	20 1 2	20 1 2	22 0 4	12 3 6	
21	Oleksii Domanytskyi (UKR)	21 0 0	21 0 0	22 0 4	12 3 6	
22	Yvnykan Azamot (BLR)	22 4 10	22 3 6	22 0 4	12 3 6	



Feuille de compétition / Competition Sheet

XXIV Memoriał Wacława Ziółkowskiego



Style: FS

70

"REPECHAGE"

"UPPER BRANCH"



"LOWER BRANCH"

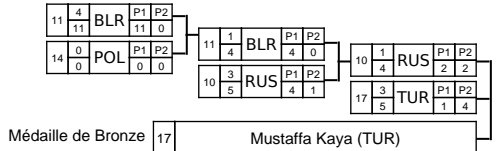

Classement

Cl	Pays	Nom
1	RUS	K. Tcabolov (RUS)
2	TUR	Yakup Gor (TUR)
3	RUS	German Ustinov (RUS)
3	TUR	Mustaffa Kaya (TUR)
5	RUS	Sharap Gitinov (RUS)
5	UKR	Oleksiy Melnyk (UKR)
7	BLR	Yvnykan Azamot (BLR)
8	GEO	Davit Tlashadze (GEO)
9	BLR	Zhan Safian (BLR)
10	SVK	Robert Olce (SVK)
11	POL	Paweł Albinowski (POL)
12	GER	Lennard Wickel (GER)
13	AUT	Philipp Crepaz (AUT)
14	POL	Damian Fałat (POL)
15	HUN	B Lagzi Kovacs (HUN)
16	POL	Arkadiusz Szeja (POL)
17-22	AFG	Mobin Hakimi (AFG)
17-22	GER	Mostafa Nasari (GER)
17-22	UKR	Oleksii Domanyskyi (UKR)
17-22	GER	Mehdi Nasari (GER)
17-22	POL	Marcin Majka (POL)
17-22	POL	Mateusz Kampik (POL)



Feuille de compétition / Competition Sheet

XXIV Memoriał Wacława Ziółkowskiego

Style: FS

74



QUALIFICATION		1/8 FINALE	1/4 FINALE	1/2 FINALE	FINALE	WINNER
1	Amirkhan Visalimov (AUT)	P1 P2 1 4 12 0	AUT	P1 P2 1 0 12 0		
2	G. Baghdasarjan (CZE)	P1 P2 2 1 2 2	CZE	P1 P2 2 0 2 0		
3	Alireza Ghasemi (IRI)	P1 P2 3 3 8 6	IRI	P1 P2 3 3 8 0		
4	Miroslav Kirov (BUL)	P1 P2 4 0 0 0	BUL	P1 P2 0 0 0 0		
5	Georg Harth (GER)	P1 P2 5 3 7 7	GER	P1 P2 4 3 6 0		
6	Andrzej Sokalski (POL)	P1 P2 6 1 2 2	POL	P1 P2 1 1 0 0		
7	Alberts Jurcenko (LAT)	P1 P2 7 0 5 5	LAT	P1 P2 5 0 4 4		
8	Zelimkhan Khadjiev (FRA)	P1 P2 8 3 5 0	FRA	P1 P2 4 0 4 0		
9	Kamil Rybicki (POL)	P1 P2 9 0 0 0				
10	S. Khachirov (RUS)	P1 P2 10 3 5 4	RUS	P1 P2 2 0 2 0		
11	Dan Palinkas (SVK)	P1 P2 11 0 0 0				
12	Andrius Mazeika (LTU)	P1 P2 12 1 3 3	RUS	P1 P2 4 8 2 5		
13	Nikita Suchkov (RUS)	P1 P2 13 4 13 7	RUS	P1 P2 4 8 2 5		
14	Martin Obst (GER)	P1 P2 14 3 2 0	GER	P1 P2 2 1 6 0		
15	Soner Demitras (TUR)	P1 P2 15 1 2 1	GER	P1 P2 1 6 0 0		
16	Peter Nagy (HUN)	P1 P2 16 1 2 2	POL	P1 P2 0 1 0 0		
17	Krystian Brzozowski (POL)	P1 P2 17 4 13 1				
18	Razaei Ghaleh Morteza (IRI)	P1 P2 18 3 6 4	IRI	P1 P2 2 2 0 0		
19	Chongyao Zhang (CHN)	P1 P2 19 1 3 3	IRI	P1 P2 4 0 0 0		
20	P Yarahmadi (IRI)	P1 P2 20 4 10 0	IRI	P1 P2 0 2 0 0		
21	Damian Woźniak (POL)	P1 P2 21 0 0 0				
22	Richard Ligeti (HUN)	P1 P2 22 0 0 0	HUN	P1 P2 0 0 0 0		
23	Mihaly Nagy (HUN)	P1 P2 23 5 13 4	JPN	P1 P2 14 0 0 0		
24	Sohsuke Takanaki (JPN)	P1 P2 24 4 10 0	JPN	P1 P2 6 4 10 0		
25	Navarro Alberto Martinez (ESP)	P1 P2 25 0 0 0				
					3	Alireza Ghasemi (IRI)



Feuille de compétition / Competition Sheet

XXIV Memoriał Wacława Ziółkowskiego



Style: FS

74

"REPECHAGE"

"UPPER BRANCH"

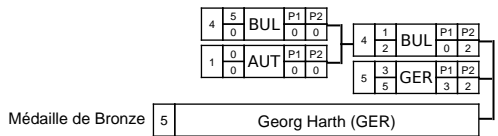

"LOWER BRANCH"

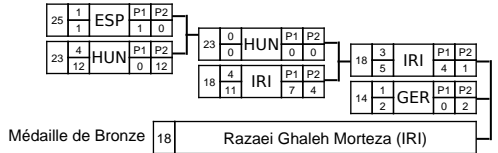

Classement

Cl	Pays	Nom
1	IRI	Alireza Ghasemi (IRI)
2	JPN	Sohsuke Takanaki (JPN)
3	IRI	Razaei Ghaleh Morteza (IRI)
3	GER	Georg Harth (GER)
5	BUL	Miroslav Kirov (BUL)
5	GER	Martin Obst (GER)
7	HUN	Mihaly Nagy (HUN)
8	FRA	Zelimkhan Khadjiev (FRA)
9	RUS	Nikita Suchkov (RUS)
10	POL	Krystian Brzozowski (POL)
11	IRI	P Yarahmadi (IRI)
12	AUT	Amirkhan Visalimov (AUT)
13	RUS	S. Khachirov (RUS)
14	CHN	Chongyao Zhang (CHN)
15	LTU	Andrius Mazeika (LTU)
16	TUR	Soner Demitras (TUR)
17	POL	Andrzej Sokalski (POL)
18	CZE	G. Baghdasarjan (CZE)
19	HUN	Peter Nagy (HUN)
20	ESP	Navarro Alberto Martinez (ESP)
21	LAT	Alberts Jurcenko (LAT)
22	POL	Kamil Rybicki (POL)
23	SVK	Dan Palinkas (SVK)
24	POL	Damian Woźniak (POL)
25	HUN	Richard Ligeti (HUN)



Feuille de compétition / Competition Sheet

XXIV Memoriał Wacława Ziółkowskiego

Style: FS

86



QUALIFICATION		1/8 FINALE	1/4 FINALE	1/2 FINALE	FINALE	WINNER	
1	Krzysztof Sadowik (POL)		1				
		P1 P2	1 0	POL	P1 P2		
			0 0	0 0			
2	Amarhajj Mahamedau (BLR)		2				
		P1 P2	2 4	BLR	P1 P2		
			12	12 0	1 3		
3	Sandro Aminashvili (GEO)		3				
		P1 P2	3 1	GEO	P1 P2		
			8	1 5			
4	Siriguleng Siriguleng (CHN)		4				
		P1 P2	4 3	CHN	P1 P2		
			14	6 8	0 0		
5	Rene Matejov (SVK)		5				
		P1 P2	5 4	SVK	P1 P2		
			12	8 4			
6	Thomas Redento (SVK)		6				
		P1 P2	6 1	SVK	P1 P2		
			2	2 0			
7	Vratislav Chotas (CZE)		7				
		P1 P2	7 0	CZE	P1 P2		
			0	0 0			
8	Michael Bodnar (SVK)		8				
		P1 P2	8 4	SVK	P1 P2		
			10	0 2			
9	Selim Yasar (TUR)		9				
		P1 P2	9 3	TUR	P1 P2		
			8	2 8	0 7		
10	William Harth (GER)		10				
		P1 P2	10 1	GER	P1 P2		
			2	2 1			
11	Yauhen Aliashkevich (BLR)		11				
		P1 P2	11 3	POL	P1 P2		
			2	2 0	0 2		
12	Radosław Marcinkiewicz (POL)		12				
		P1 P2	12 3	POL	P1 P2		
			10	0 3			
13	Aron Caneva (ITA)		13				
		P1 P2	13 0	ITA	P1 P2		
			0	0 0			
14	Aliaksandr Hushtyn (BLR)		14				
		P1 P2	14 1	POL	P1 P2		
			4	0	2 4		
15	Zbigniew Baranowski (POL)		15				
		P1 P2	15 3	TUR	P1 P2		
			2	2 0			
16	Lilia Archaia (UKR)		16				
		P1 P2	16 1	TUR	P1 P2		
			7	0 7			
17	Ahmet Bilici (TUR)		17				
		P1 P2	17 3	TUR	P1 P2		
			4	10			
18	Mihail Ganev (BUL)		18				
		P1 P2	18 3	BUL	P1 P2		
			2	2 0			
19	Gergely Gyurits (HUN)		19				
		P1 P2	19 1	BUL	P1 P2		
			0	0 0	4 0		
20	Michał Szymański (POL)		20				
		P1 P2	20 1	FRA	P1 P2		
			0	0 1			
21	Akhmed Aibuev (FRA)		21				
		P1 P2	21 4	POL	P1 P2		
			8	2 0	1 0		
22	Sebastian Jezierzański (POL)		22				
		P1 P2	22 3	POL	P1 P2		
			1	3 0	8		
23	Armands Zvirbulis (LAT)		23				
		P1 P2	23 3	POL	P1 P2		
			0	1 0	7 0		
24	Jumber Kvelashvili (GEO)		24				
		P1 P2	24 1	GEO	P1 P2		
			0	4 1	3		
25	Patryk Dublinowski (POL)		25				
		P1 P2	25 1	POL	P1 P2		
			3	0 0			
						9	Selim Yasar (TUR)

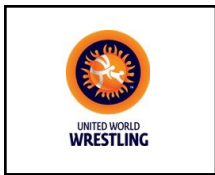

Feuille de compétition / Competition Sheet
XXIV Memoriał Wacława Ziółkowskiego



Style: FS

86

"REPECHAGE"

"UPPER BRANCH"

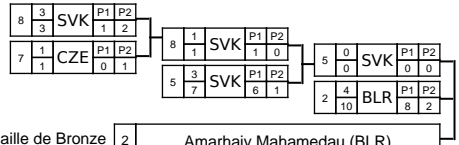

Médaille de Bronze 2 Amarhajy Mahamedau (BLR)

"LOWER BRANCH"

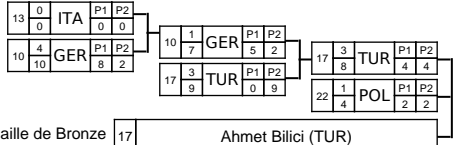

Médaille de Bronze 17 Ahmet Bilici (TUR)

Classement

Cl	Pays	Nom
1	TUR	Selim Yasar (TUR)
2	POL	Radosław Marcinkiewicz (POL)
3	TUR	Ahmet Bilici (TUR)
3	BLR	Amarhajy Mahamedau (BLR)
5	SVK	Rene Matejov (SVK)
5	POL	Sebastian Jezierzański (POL)
7	GER	William Harth (GER)
8	BUL	Mihail Ganev (BUL)
9	FRA	Akhmed Aibuev (FRA)
10	POL	Zbigniew Baranowski (POL)
11	GEO	Jumber Kvelashvili (GEO)
12	SVK	Michael Bodnar (SVK)
13	CHN	Siriguleng Siriguleng (CHN)
14	UKR	Lilia Archaia (UKR)
15	GEO	Sandro Aminashvili (GEO)
16	BLR	Aliaksandr Hushtyn (BLR)
17	POL	Patryk Dublinowski (POL)
18	BLR	Yauhen Aliashkevich (BLR)
19	SVK	Thomas Redento (SVK)
20	LAT	Armands Zvirbulis (LAT)
21	CZE	Vratislav Chotas (CZE)
22	HUN	Gergely Gyurits (HUN)
23	POL	Michał Szymański (POL)
24	POL	Krzysztof Sadowik (POL)
25	ITA	Aron Caneva (ITA)



Feuille de compétition / Competition Sheet

XXIV Memoriał Wacława Ziółkowskiego

Style: FS

97



QUALIFICATION		1/8 FINALE	1/4 FINALE	1/2 FINALE	FINALE	WINNER
1	Radosław Baran (POL)	P1 P2 3 10	POL P1 P2 2 8	1 3 10 POL P1 P2 5 5	1 1 4 POL P1 P2 2 2	8 3 3 IRI P1 P2 0 3
2	Yusup Dzalievov (BLR)	P1 P2 1 6	BLR P1 P2 3 3			
3	Legoaskis Imantas (LAT)	P1 P2 1 3	LAT P1 P2 0 3	4 1 4 UKR P1 P2 4 0		
4	Hleb Kutey (UKR)	P1 P2 3 5	UKR P1 P2 2 3			
5	Ragnar Kaasik (EST)	P1 P2 0 0	EST P1 P2 0 0	6 1 6 KGZ P1 P2 2 4		
6	Alexey Krupnyakov (KGZ)	P1 P2 4 10	KGZ P1 P2 10 0			
7	Can Zeybek Yusuf (TUR)	P1 P2 1 2	TUR P1 P2 2 0	8 3 6 IRI P1 P2 6 0		
8	Tahan Abbas (IRI)	P1 P2 3 9	IRI P1 P2 5 4			
9	Stefan Kehrer (GER)	P1 P2 4 10	GER P1 P2 10 0	9 0 2 GER P1 P2 2 0		
10	Xueyi Zhang (CHN)	P1 P2 0 0	CHN P1 P2 0 0			
11	Ibrahim Bolukbasi (TUR)	P1 P2 0 4	TUR P1 P2 3 4	11 1 2 TUR P1 P2 2 0		
12	Maciej Balawender (POL)	P1 P2 4 0	TUR P1 P2 2 3			
13	Gennadij Cudinovic (GER)	P1 P2 0 3	GER P1 P2 4 2	21 1 1 GEO P1 P2 1 0		
14	Jozef Jaloviar (SVK)	P1 P2 2 0	IRI P1 P2 0 0			
15	Mohammadossein	P1 P2 5 0	IRI P1 P2 0 0	15 1 2 IRI P1 P2 0 2		
16	Hector Rodriguez Iglesias (ESP)	P1 P2 0 0	BLR P1 P2 0 0			
17	Ivan Yankovski (BLR)	P1 P2 8 0	BLR P1 P2 0 0	21 3 3 GEO P1 P2 0 3		
18	Ibrahim Saidau (BLR)	P1 P2 0 6	GEO P1 P2 1 4			
19	Aly Hamdy Amin Rabei (EGY)	P1 P2 0 0	JPN P1 P2 0 0	21 3 5 GEO P1 P2 1 4		
20	Tolaski Yamaguchi (JPN)	P1 P2 2 3	GEO P1 P2 4 1			
21	Elizbar Odikadze (GEO)	P1 P2 3 5	GEO P1 P2 4 1			
22	Riza Yildirim (TUR)	P1 P2 2 0				
						8 Tahan Abbas (IRI)

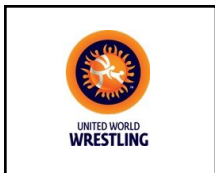

Feuille de compétition / Competition Sheet

XXIV Memoriał Wacława Ziółkowskiego



Style: FS

97

"REPECHAGE"

"UPPER BRANCH"

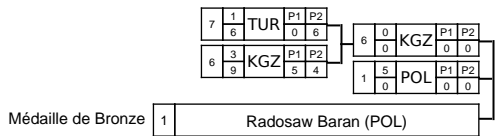

"LOWER BRANCH"

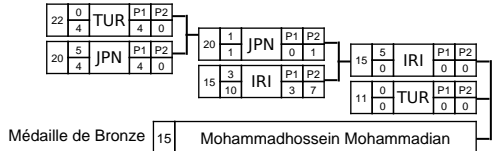

Classement		
Cl	Pays	Nom
1	IRI	Tahan Abbas (IRI)
2	GEO	Elizbar Odikadze (GEO)
3	IRI	Mohammadhossein Mohammadian (IRI)
3	POL	Radosław Baran (POL)
5	TUR	Ibrahim Bolukbasi (TUR)
5	KGZ	Alexey Krupnyakov (KGZ)
7	JPN	Tolaski Yamaguchi (JPN)
8	GER	Stefan Kehrer (GER)
9	UKR	Hleb Kutey (UKR)
10	GER	Gennadij Cudinovic (GER)
11	BLR	Ivan Yankovski (BLR)
12	TUR	Can Zeybek Yusuf (TUR)
13	BLR	Ibrahim Saidau (BLR)
14	BLR	Yusup Dzalievov (BLR)
15	POL	Maciej Balawender (POL)
16	LAT	Legoaskis Imantas (LAT)
17	SVK	Jozef Jaloviar (SVK)
18	TUR	Riza Yildirim (TUR)
19	EGY	Aly Hamdy Amin Rabei (EGY)
20-21	CHN	Xueyi Zhang (CHN)
20-21	EST	Ragnar Kaasik (EST)
22	ESP	Hector Rodriguez Iglesias (ESP)



Feuille de compétition / Competition Sheet

XXIV Memoriał Wacława Ziółkowskiego



Style: FS

125

QUALIFICATION	1/4 FINALE	1/2 FINALE	FINALE	WINNER
---------------	------------	------------	--------	--------



10 Geno Petriashvili (GEO)



Feuille de compétition / Competition Sheet

XXIV Memoriał Wacława Ziółkowskiego



Style: FS

125

"REPECHAGE"

"UPPER BRANCH"

1	0	EGY	P1	P2
0	0		0	0
5	4	GER	P1	P2
10	10		10	0

Médaille de Bronze 5 Nick Matuhin (GER)

"LOWER BRANCH"

11	0	POL	P1	P2
0	0		0	0
12	4	CHN	P1	P2
10	10		10	0
12	5	CHN	P1	P2
0	0		0	0
8	0	RUS	P1	P2
0	0		0	0

Médaille de Bronze 12 Zhiwei Deng (CHN)

Classement		
Cl	Pays	Nom
1	GEO	Geno Petriashvili (GEO)
2	BLR	Aleksei Nikolaev (BLR)
3	CHN	Zhiwei Deng (CHN)
3	GER	Nick Matuhin (GER)
5	RUS	Muradin Kushkhov (RUS)
5	EGY	Khaled Omr Mohamed (EGY)
7	ESP	Jose Cuba (ESP)
8	RUS	Eduar Bazrov (RUS)
9	POL	Karol Turczyński (POL)
10	CHN	Hai Shang (CHN)
11	POL	Kamil Kościótek (POL)
12-13	POL	Robert Baran (POL)
12-13	HUN	Mihaly Nagy (HUN)