



PREGLED SUDJELOVANJA

23. croatia open za kadete GR - GR

R.br.	EKIPA	MJESTO	42 kg	46 kg	50 kg	54 kg	58 kg	63 kg	69 kg	76 kg	85 kg	100 kg	Ukupno
1	CROATIA							2	1	2	3		8
2	croatia kad		1		1	1	3	2	3	2	1	2	16
3	HUNGARY		1		2	1	3	1	3	2	3	1	17
4	ITALY			1	1	1	1	1	1	1			7
5	NORWAY					1	2		1				4
6	SERBIA		1	1		1	2	2	1	1	1	1	11
7	SLOVENIA						1		1				2
8	SWEDEN						1	1	1	1			4
UKUPNO NATJECATELJA			3	2	4	5	13	9	12	9	8	4	69



TABLICA ELIMINACIJE

23. croatia open za kadete GR - GR - 42 kg

R.br.	Hrvač	Ekipa	1	2	3	PP	PL.
1	KOZBAŠIĆ Marko	SERBIA		0	0	0	3.
2	IVIĆ Juraj	croatia kad	3		0	3	2.
3	PASTZOR Richard	HUNGARY	4	4		8	1.

N1

1	$\frac{0}{0}$	KOZBAŠIĆ Marko	SRB	$\frac{P1P2P3}{0\ 0\ 0}$
2	$\frac{3}{3}$	IVIĆ Juraj	cro	$\frac{P1P2P3}{0\ 3\ 0}$

N2

3	$\frac{4}{4}$	PASTZOR Richard	HUN	$\frac{P1P2P3}{4\ 0\ 0}$
1	$\frac{0}{0}$	KOZBAŠIĆ Marko	SRB	$\frac{P1P2P3}{0\ 0\ 0}$

N3

2	$\frac{0}{0}$	IVIĆ Juraj	cro	$\frac{P1P2P3}{0\ 0\ 0}$
3	$\frac{4}{10}$	PASTZOR Richard	HUN	$\frac{P1P2P3}{10\ 0\ 0}$

KONAČNI POREDAK

Plasman	Hrvač	Ekipa
1	PASTZOR Richard	HUN
2	IVIĆ Juraj	cro kad
3	KOZBAŠIĆ Marko	SRB



TABLICA ELIMINACIJE

23. croatia open za kadete GR - GR - 46 kg

R.br.	Hrvač	Ekipa	1	2	PP	PL.
1	MENGHETI Nikola	ITALY		4	4	1.
2	DEDIĆ Nikola	SERBIA	0		0	2.

N1

1	$\frac{4}{8}$	MENGHETI Nikola	ITA	$\frac{P1P2P3}{8\ 0}$
2	$\frac{0}{0}$	DEDIĆ Nikola	SRB	$\frac{P1P2P3}{0\ 0}$

KONAČNI POREDAK

Plasman	Hrvač	Ekipa
1	MENGHETI Nikola	ITA
2	DEDIĆ Nikola	SRB



TABLICA ELIMINACIJE

23. croatia open za kadete GR - GR - 50 kg

R.br.	Hrvač	Ekipa	1	2	3	4	PP	PL.
1	VANCZA Istvan	HUNGARY		4	3	4	11	1.
2	ŠAČIĆ Fran	croatia kad	0		0	3	3	3.
3	KECSKEMETI Ksisztian	HUNGARY	0	4		4	8	2.
4	GLAVE Ricardo	ITALY	1	1	1		3	4.

N1

1	$\frac{4}{8}$	VANCZA Istvan	HUN	$\frac{P1P2P3}{6\ 2}$
---	---------------	---------------	-----	-----------------------

2	$\frac{0}{0}$	ŠAČIĆ Fran	cro	$\frac{P1P2P3}{0\ 0}$
---	---------------	------------	-----	-----------------------

3	$\frac{4}{14}$	KECSKEMETI Ksisztian	HUN	$\frac{P1P2P3}{6\ 8}$
---	----------------	----------------------	-----	-----------------------

4	$\frac{1}{6}$	GLAVE Ricardo	ITA	$\frac{P1P2P3}{5\ 1}$
---	---------------	---------------	-----	-----------------------

N2

1	$\frac{3}{4}$	VANCZA Istvan	HUN	$\frac{P1P2P3}{4\ 0}$
---	---------------	---------------	-----	-----------------------

3	$\frac{0}{0}$	KECSKEMETI Ksisztian	HUN	$\frac{P1P2P3}{0\ 0}$
---	---------------	----------------------	-----	-----------------------

2	$\frac{3}{6}$	ŠAČIĆ Fran	cro	$\frac{P1P2P3}{0\ 6}$
---	---------------	------------	-----	-----------------------

4	$\frac{1}{5}$	GLAVE Ricardo	ITA	$\frac{P1P2P3}{5\ 0}$
---	---------------	---------------	-----	-----------------------

N3

1	$\frac{4}{9}$	VANCZA Istvan	HUN	$\frac{P1P2P3}{4\ 5}$
---	---------------	---------------	-----	-----------------------

4	$\frac{1}{1}$	GLAVE Ricardo	ITA	$\frac{P1P2P3}{0\ 1}$
---	---------------	---------------	-----	-----------------------

2	$\frac{0}{0}$	ŠAČIĆ Fran	cro	$\frac{P1P2P3}{0\ 0}$
---	---------------	------------	-----	-----------------------

3	$\frac{4}{8}$	KECSKEMETI Ksisztian	HUN	$\frac{P1P2P3}{8\ 0}$
---	---------------	----------------------	-----	-----------------------

KONAČNI POREDAK

Plasman	Hrvač	Ekipa
1	VANCZA Istvan	HUN
2	KECSKEMETI Ksisztian	HUN
3	ŠAČIĆ Fran	cro kad
4	GLAVE Ricardo	ITA



TABLICA ELIMINACIJE

23. croatia open za kadete GR - GR - 54 kg

R.br.	Hrvač	Ekipa	1	2	3	4	5	PP	PL
1	TOROK Tamas	HUNGARY		0	4	1	4	9	3.
2	FRENI Giovanni	ITALY	4		4	4	4	16	1.
3	SIMONSEN Tobias	NORWAY	1	0		0	0	1	5.
4	KOLOMPAR Sebastian	SERBIA	4	0	4		3	11	2.
5	BORECKI David	croatia kad	1	0	3	1		5	4.

N1

1	0	TOROK Tamas	HUN	P1P2P3	0	0
2	4	FRENI Giovanni	ITA	P1P2P3	9	0

3	0	SIMONSEN Tobias	NOR	P1P2P3	0	0
4	4	KOLOMPAR Sebastian	SRB	P1P2P3	0	8

N2

5	1	BORECKI David	cro	P1P2P3	3	1
1	4	TOROK Tamas	HUN	P1P2P3	5	7

2	4	FRENI Giovanni	ITA	P1P2P3	8	0
3	0	SIMONSEN Tobias	NOR	P1P2P3	0	0

N3

4	4	KOLOMPAR Sebastian	SRB	P1P2P3	10	0
1	1	TOROK Tamas	HUN	P1P2P3	1	0

5	0	BORECKI David	cro	P1P2P3	0	0
2	4	FRENI Giovanni	ITA	P1P2P3	10	0

N4

3	1	SIMONSEN Tobias	NOR	P1P2P3	4	0
1	4	TOROK Tamas	HUN	P1P2P3	12	0

4	3	KOLOMPAR Sebastian	SRB	P1P2P3	6	2
5	1	BORECKI David	cro	P1P2P3	2	6

N5

2	4	FRENI Giovanni	ITA	P1P2P3	8	0
4	0	KOLOMPAR Sebastian	SRB	P1P2P3	0	0

3	0	SIMONSEN Tobias	NOR	P1P2P3	0	0
5	3	BORECKI David	cro	P1P2P3	1	2

KONAČNI POREDAK

Plasman	Hrvač	Ekipa
1	FRENI Giovanni	ITA
2	KOLOMPAR Sebastian	SRB
3	TOROK Tamas	HUN
4	BORECKI David	cro kad
5	SIMONSEN Tobias	NOR



TABLICA ELIMINACIJE

23. croatia open za kadete GR - GR - 58 kg

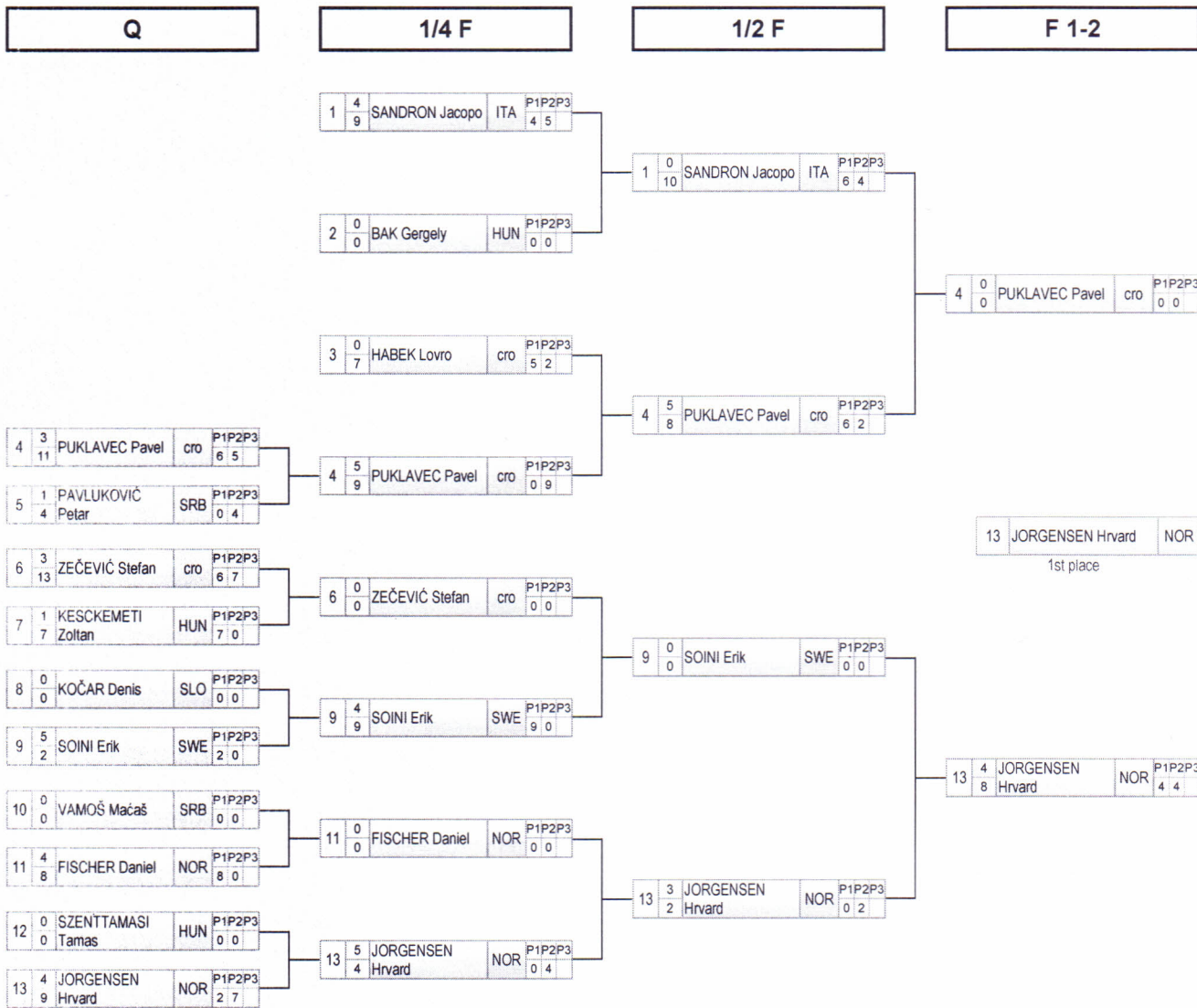

Repechage A

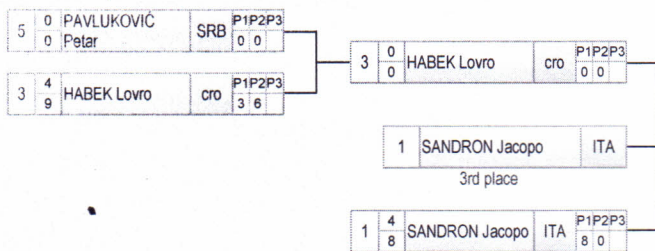

Repechage B

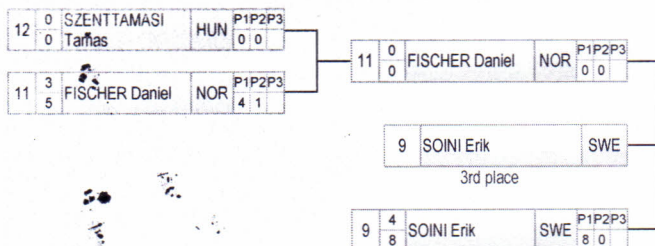

KONAČNI POREDAK

Plasman	Hrvač	Ekipa
1	JORGENSEN Hrvard	NOR
2	PUKLAVEC Pavel	cro kad
3	SANDRON Jacopo	ITA
3	SOINI Erik	SWE
5	HABEK Lovro	cro kad
5	FISCHER Daniel	NOR
7	ZEČEVIĆ Stefan	cro kad
8	KESCKEMETI Zoltan	HUN
9	PAVLUKOVIĆ Petar	SRB
10	KOČAR Denis	SLO
11	VAMOŠ Mačaš	SRB
12	BAK Gergely	HUN
13	SZENTTAMASI Tamas	HUN



TABLICA ELIMINACIJE

23. croatia open za kadete GR - GR - 63 kg

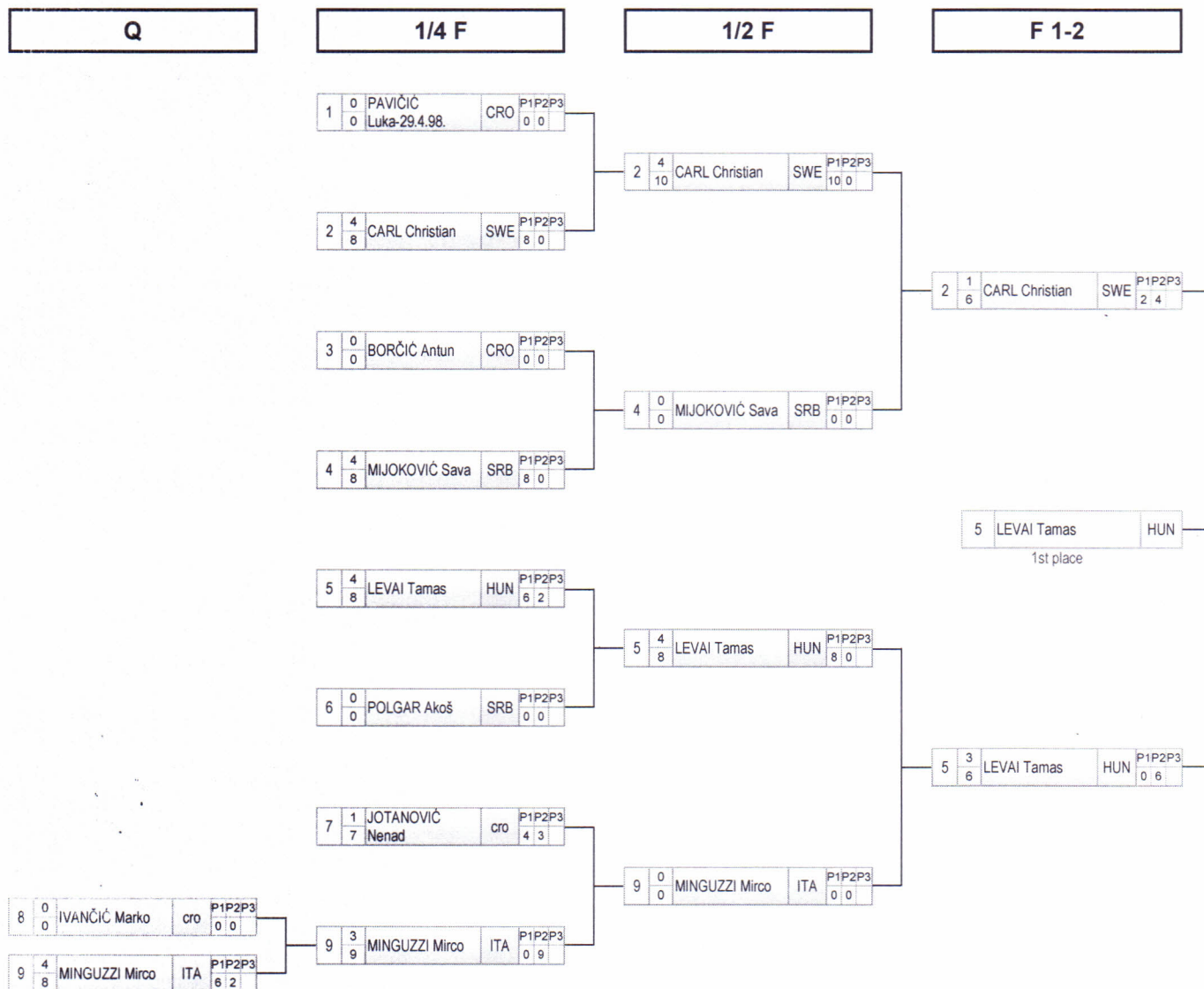

KONAČNI POREDAK

Plasman	Hrvat	Ekipa
1	LEVAI Tamas	HUN
2	CARL Christian	SWE
3	MIJOKOVIĆ Sava	SRB
3	POLGAR Akoš	SRB
5	PAVIČIĆ Luka-29.4.98.	CRO
5	MINGUZZI Mirco	ITA
7	JOTANOVIĆ Nenad	cro kad
8	BORČIĆ Antun	CRO
8	IVANČIĆ Marko	cro kad

Repechage A



Repechage B

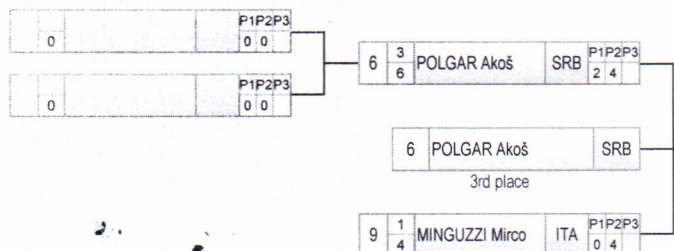



TABLICA ELIMINACIJE

23. croatia open za kadete GR - GR - 69 kg

Q **1/4 F** **1/2 F** **F 1-2**

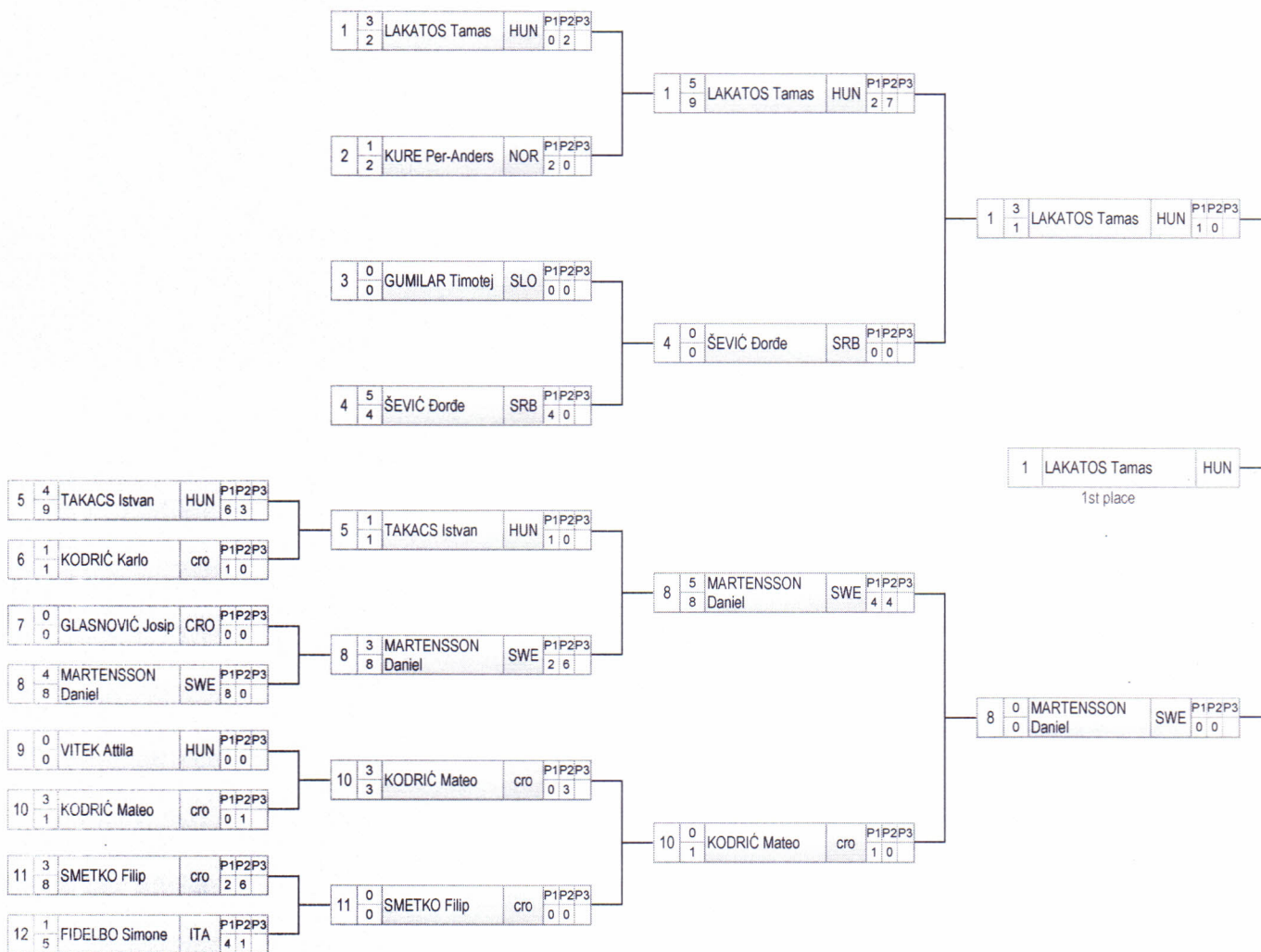

Repechage A

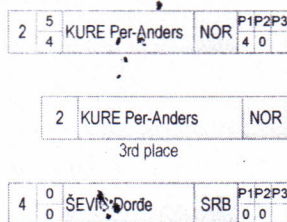

Repechage B

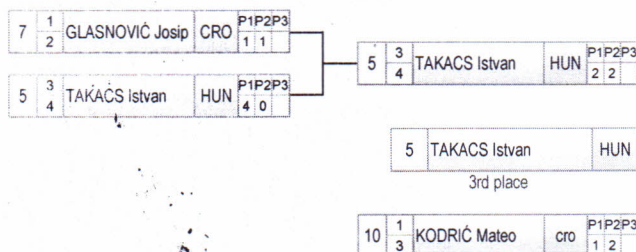

KONAČNI POREDAK

Plasman	Hrvač	Ekipa
1	LAKATOS Tamas	HUN
2	MARTENSSON Daniel	SWE
3	KURE Per-Anders	NOR
3	TAKACS Istvan	HUN
5	ŠEVIĆ Đorđe	SRB
5	KODRIĆ Mateo	cro kad
7	SMETKO Filip	cro kad
8	FIDELBO Simone	ITA
9	GLASNOVIĆ Josip	CRO
10	KODRIĆ Karlo	cro kad
11	VITEK Attila	HUN
12	GUMILAR Timotej	SLO



TABLICA ELIMINACIJE

23. croatia open za kadete GR - GR - 76 kg

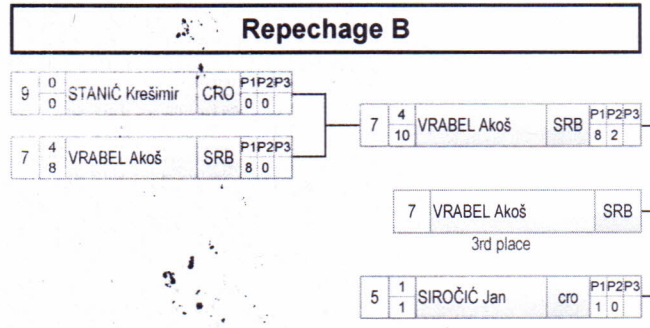
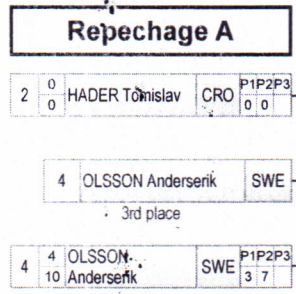
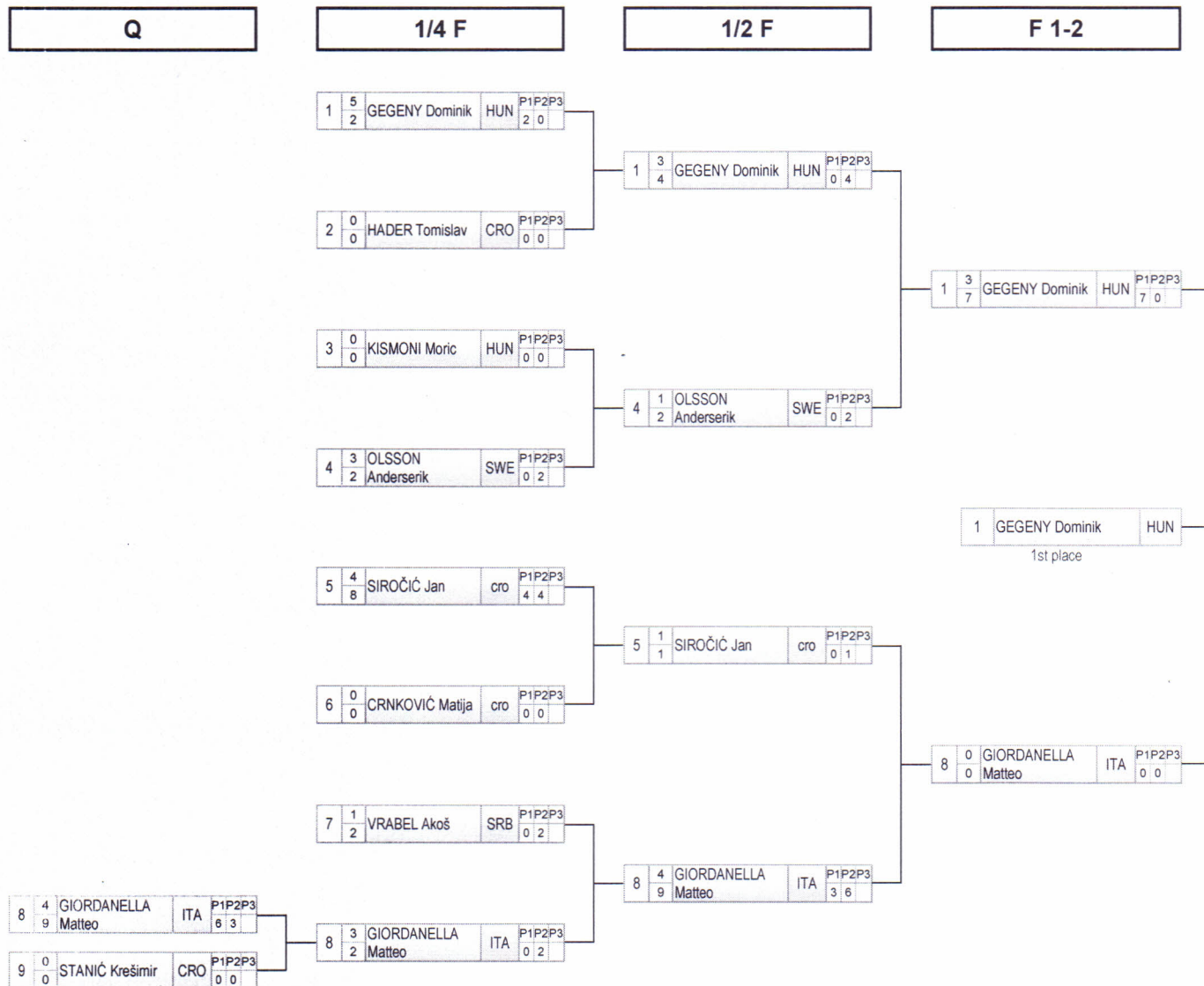

KONAČNI POREDAK

Plasman	Hrvač	Ekipa
1	GEGENY Dominik	HUN
2	GIORDANELLA Matteo	ITA
3	OLSSON Anderserik	SWE
3	VRABEL Akoš	SRB
5	HADER Tomislav	CRO
5	SIROČIĆ Jan	cro kad
7	KISMONI Moric	HUN
8	CRNKOVIĆ Matija	cro kad
9	STANIĆ Krešimir	CRO



TABLICA ELIMINACIJE

23. croatia open za kadete GR - GR - 85 kg

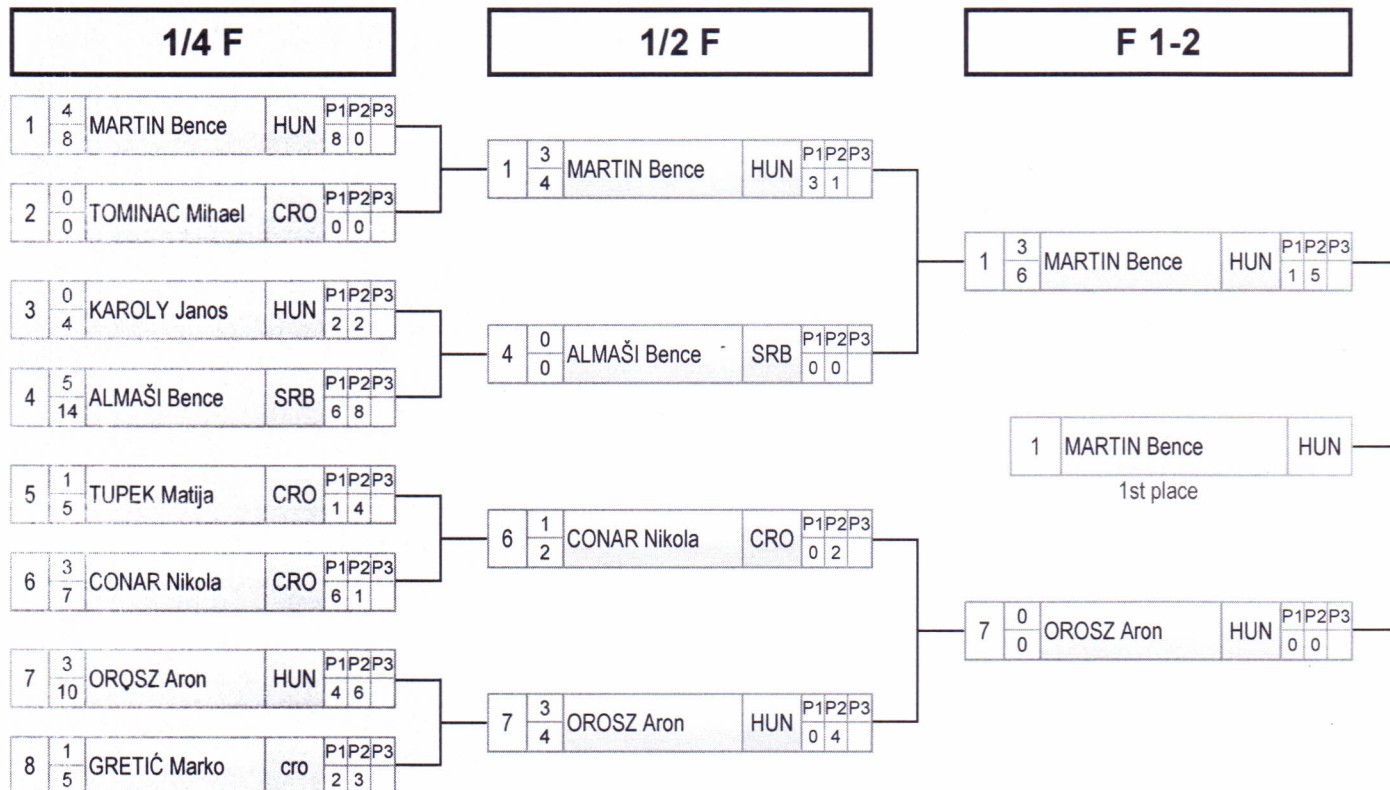

KONAČNI POREDAK

Repechage A

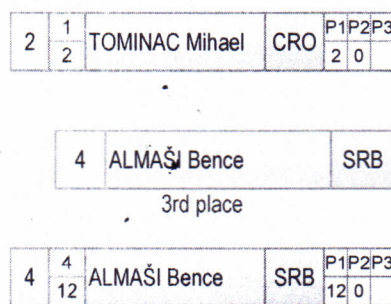

Repechage B



Plasman	Hrvač	Ekipa
1	MARTIN Bence	HUN
2	OROSZ Aron	HUN
3	ALMAŠI Bence	SRB
3	GRETIĆ Marko	cro kad
5	TOMINAC Mihael	CRO
5	CONAR Nikola	CRO
7	TUPEK Matija	CRO
8	KAROLY Janos	HUN



TABLICA ELIMINACIJE

23. croatia open za kadete GR - GR - 100 kg

R.br.	Hrvač	Ekipa	1	2	3	4	PP	PL.
1	ERSEK Robert	HUNGARY		4	4	4	12	1.
2	SABADY Dominik	croatia kad	0		4	4	8	2.
3	RUNAC Petar	croatia kad	0	0		1	1	4.
4	PANTELIĆ Aleksandar	SERBIA	0	0	3		3	3.

N1

1	4	ERSEK Robert	HUN	P1P2P3
	10			10 0
2	0	SABADY Dominik	cro	P1P2P3
	0			0 0

3	1	RUNAC Petar	cro	P1P2P3
	4			0 4
4	3	PANTELIĆ Aleksandar	SRB	P1P2P3
	6			2 4

N2

1	4	ERSEK Robert	HUN	P1P2P3
	9			9 0
3	0	RUNAC Petar	cro	P1P2P3
	0			0 0

2	4	SABADY Dominik	cro	P1P2P3
	4			4 0
4	0	PANTELIĆ Aleksandar	SRB	P1P2P3
	0			0 0

N3

1	4	ERSEK Robert	HUN	P1P2P3
	10			10 0
4	0	PANTELIĆ Aleksandar	SRB	P1P2P3
	0			0 0

2	4	SABADY Dominik	cro	P1P2P3
	4			4 0
3	0	RUNAC Petar	cro	P1P2P3
	0			0 0

KONAČNI POREDAK

Plasman	Hrvač	Ekipa
1	ERSEK Robert	HUN
2	SABADY Dominik	cro kad
3	PANTELIĆ Aleksandar	SRB
4	RUNAC Petar	cro kad



POJEDINAČNI POREDAK PO KATEGORIJAMA

23. croatia open za kadete GR - GR

42 kg			
1	PASTZOR Richard	HUNGARY	7.0
2	IVIĆ Juraj	croatia kad	5.0
3	KOZBAŠIĆ Marko	SERBIA	3.5
			15.5
46 kg			
1	MENGHETI Nikola	ITALY	7.0
2	DEDIĆ Nikola	SERBIA	5.0
			12.0
50 kg			
1	VANCSA Istvan	HUNGARY	7.0
2	KECSKEMETI Kszisztian	HUNGARY	5.0
3	ŠAČIĆ Fran	croatia kad	3.5
4	GLAVE Ricardo	ITALY	3.5
			19.0
54 kg			
1	FRENI Giovanni	ITALY	7.0
2	KOLOMPAR Sebastian	SERBIA	5.0
3	TOROK Tamas	HUNGARY	3.5
4	BORECKI David	croatia kad	3.5
			19.0
58 kg			
1	JORGENSEN Hvard	NORWAY	7.0
2	PUKLAVEC Pavel	croatia kad	5.0
3	SANDRON Jacopo	ITALY	3.5
3	SJÖLIN Erik	SWEDEN	3.5
			19.0
63 kg			
1	LEVAI Tamas	HUNGARY	7.0
2	CARL Christian	SWEDEN	5.0
3	MIJOKOVIĆ Sava	SERBIA	3.5
3	POLGAR Akoš	SERBIA	3.5
			19.0
69 kg			
1	LAKATOS Tamas	HUNGARY	7.0
2	MARTENSSON Daniel	SWEDEN	5.0
3	KURE Per-Anders	NORWAY	3.5
3	TAKACS Istvan	HUNGARY	3.5
			19.0
76 kg			
1	GÉGENY Dominik	HUNGARY	7.0
2	GIORDANELLA Matteo	ITALY	5.0
3	OLSSON Anderserik	SWEDEN	3.5
3	FRABEL Akoš	SERBIA	3.5
			19.0
85 kg			
1	MARTIN Bence	HUNGARY	7.0
2	ROSZ Aron	HUNGARY	5.0
3	ALMAŠI Bence	SERBIA	3.5
3	GRETIĆ Marko	croatia kad	3.5
			19.0
100 kg			
1	ERSEK Robert	HUNGARY	7.0



POJEDINAČNI POREDAK PO KATEGORIJAMA

23. croatia open za kadete GR - GR

2	SABADY Dominik	croatia kad	5.0
3	PANTELIĆ Aleksandar	SERBIA	3.5
4	RUNAC Petar	croatia kad	3.5
			19.0



EKIPNI PLASMAN

23. croatia open za kadete GR - GR

R.br.	EKIPA	MJESTO	42 kg	46 kg	50 kg	54 kg	58 kg	63 kg	69 kg	76 kg	85 kg	100 kg	Ukupno
1	HUNGARY		7.0		12.0	3.5		7.0	10.5	7.0	12.0	7.0	66.0
2	SERBIA		3.5	5.0		5.0		7.0		3.5	3.5	3.5	31.0
3	croatia kad		5.0		3.5	3.5	5.0				3.5	8.5	29.0
4	ITALY			7.0	3.5	7.0	3.5			5.0			26.0
5	SWEDEN						3.5	5.0	5.0	3.5			17.0
6	NORWAY						7.0		3.5				10.5
7	CROATIA												0.0
8	SLOVENIA												0.0
UKUPNO			15.5	12	19	19	19	19	19	19	19	19	179.5