

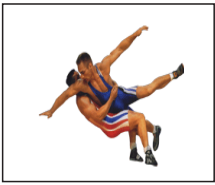

Feuille de compétition / Competition Sheet

Veteran WCH DIV A



STYLE : FS 58 kg

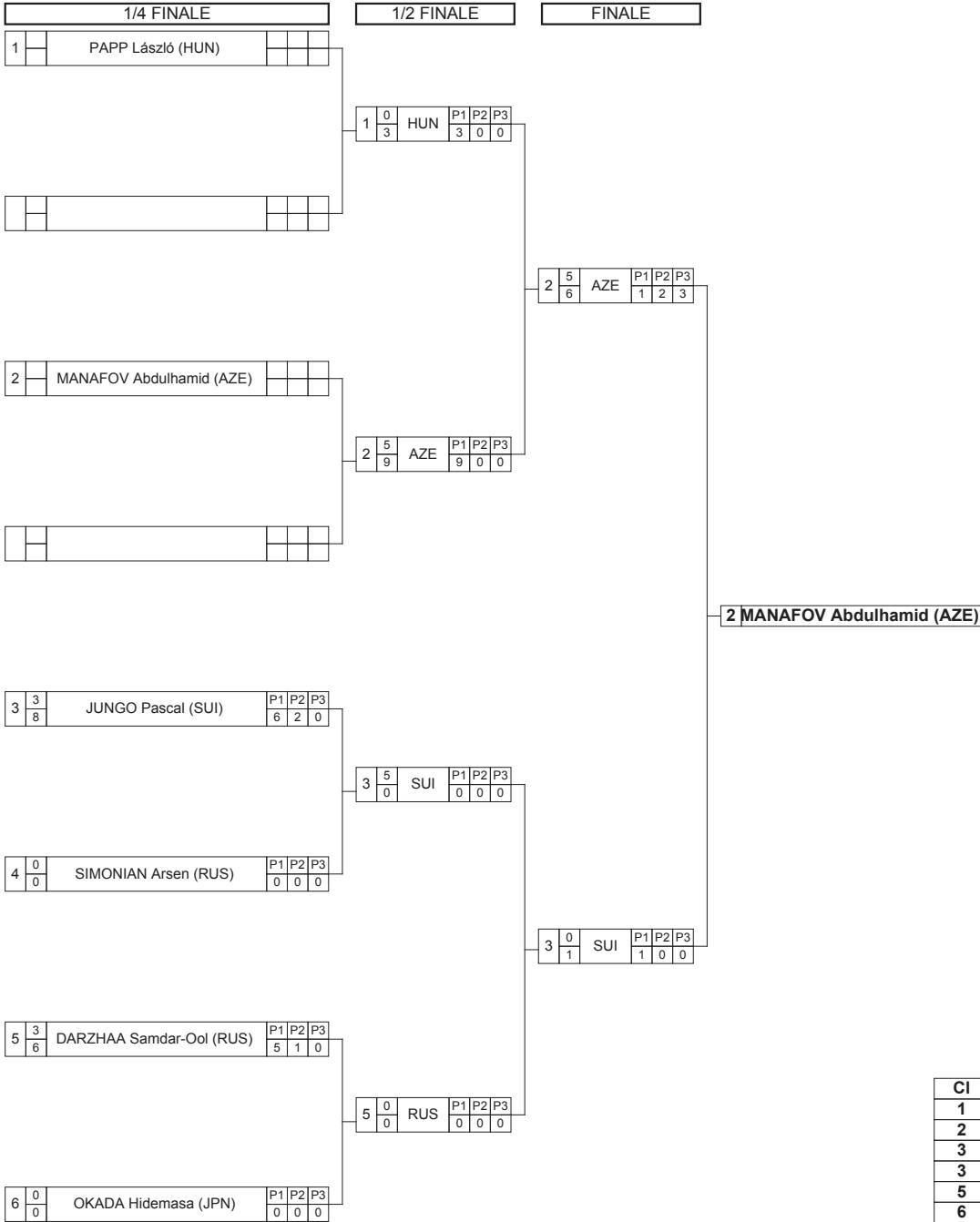

Classement

Cl	Pays	Nom
1	AZE	MANAFOV Abdulhamid
2	SUI	JUNGO Pascal
3	HUN	PAPP László
3	RUS	DARZHAA Samdar-Ool
5	RUS	SIMONIAN Arsen
6	JPN	OKADA Hidemasa

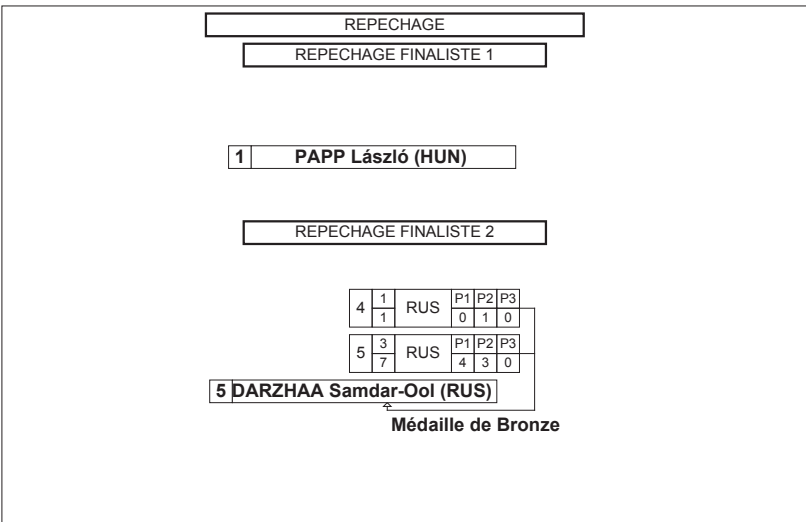



Feuille de compétition / Competition Sheet

Veteran WCH DIV A

STYLE : FS 63 kg

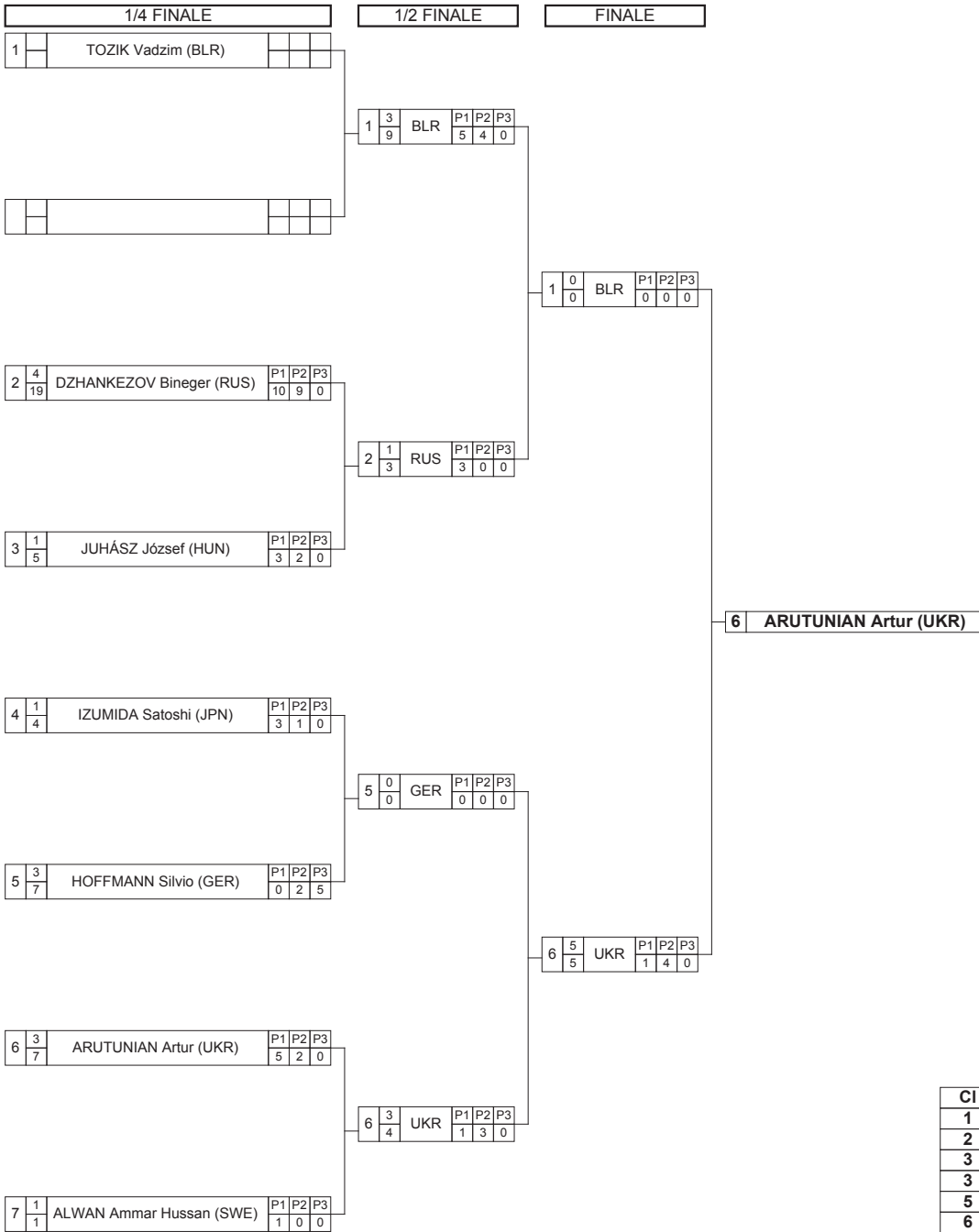

Classement

Cl	Pays	Nom
1	UKR	ARUTUNIAN Artur
2	BLR	TOZIK Vadzim
3	RUS	DZHANKEZOV Bineger
3	SWE	ALWAN Ammar Hussan
5	GER	HOFFMANN Silvio
6	HUN	JUHÁSZ József
7	JPN	IZUMIDA Satoshi

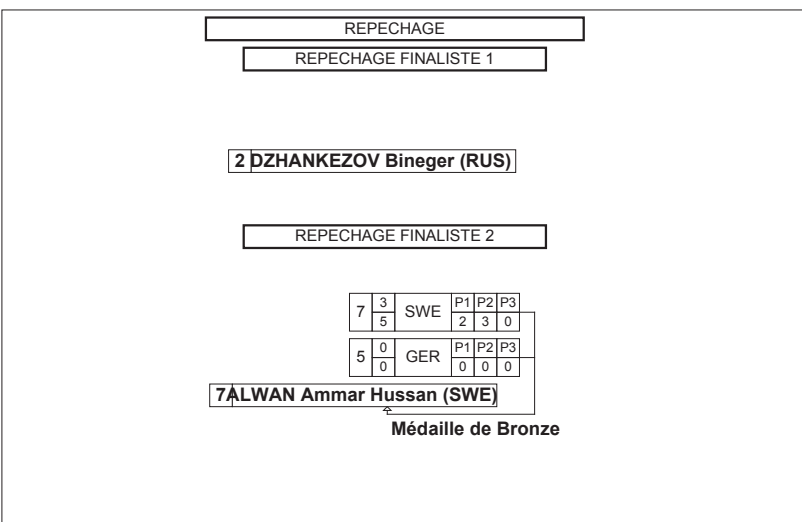



Feuille de compétition / Competition Sheet

Veteran WCH DIV A

STYLE : FS 69 kg

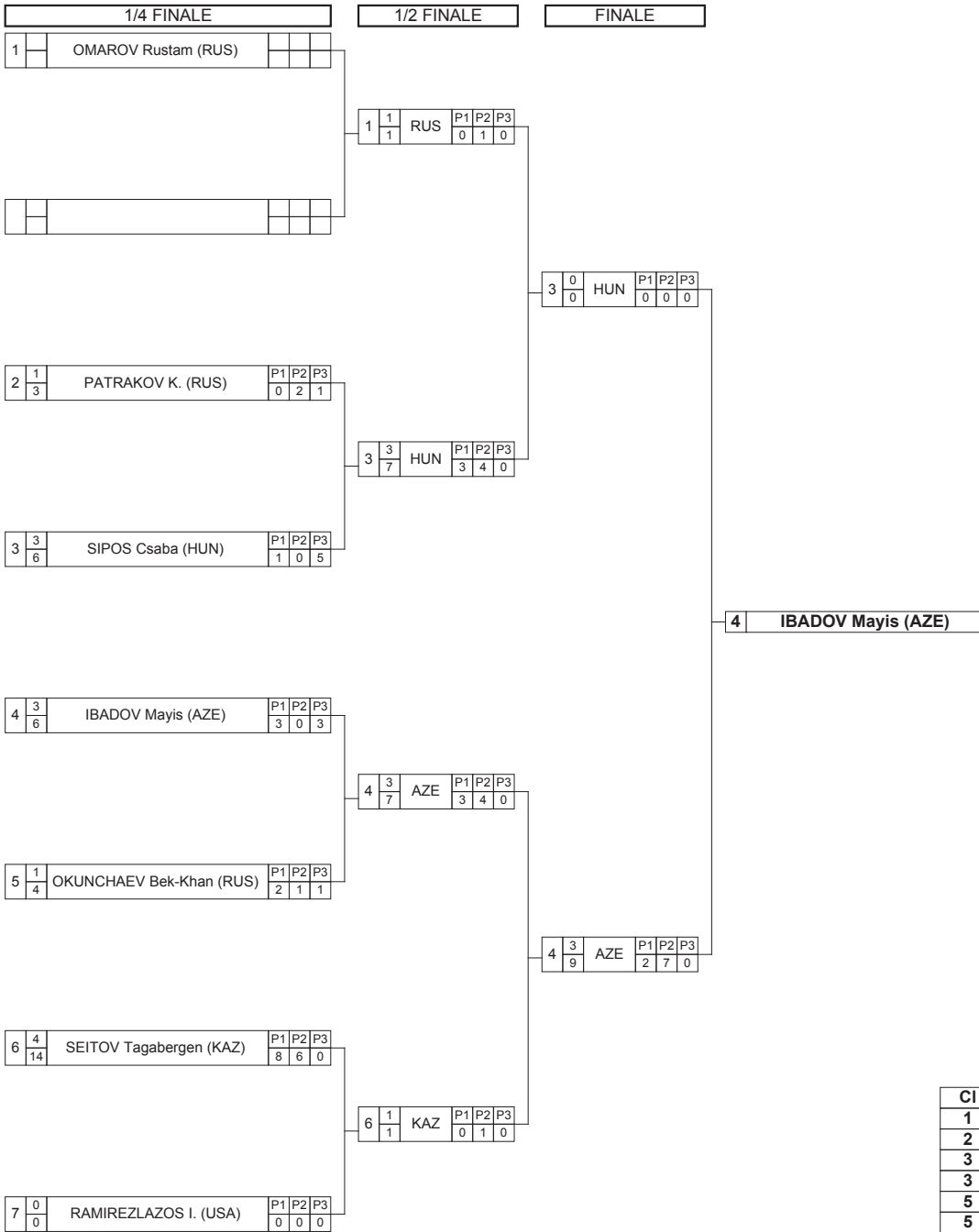

Classement

Cl	Pays	Nom
1	AZE	IBADOV Mayis
2	HUN	SIPOS Csaba
3	RUS	PATRAKOV Konstantin
3	KAZ	SEITOV Tagabergen
5	RUS	OMAROV Rustam
5	RUS	OKUNCHAEV Bek-Khan
7	USA	RAMIREZLAZOS I.

REPECHAGE

REPECHAGE FINALISTE 1

2	3	4	RUS	P1	P2	P3									
				3	1	0									
1	0	0	RUS	P1	P2	P3									
				0	0	0									

2 PATRAKOV K. (RUS)

Médaille de Bronze

REPECHAGE FINALISTE 2

5	0	0	RUS	P1	P2	P3									
				0	0	0									
6	5	4	KAZ	P1	P2	P3									
				4	0	0									

6 SEITOV Tagabergen (KAZ)

Médaille de Bronze



Feuille de compétition / Competition Sheet

Veteran WCH DIV A

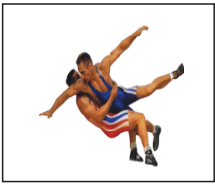

STYLE : FS 76 kg

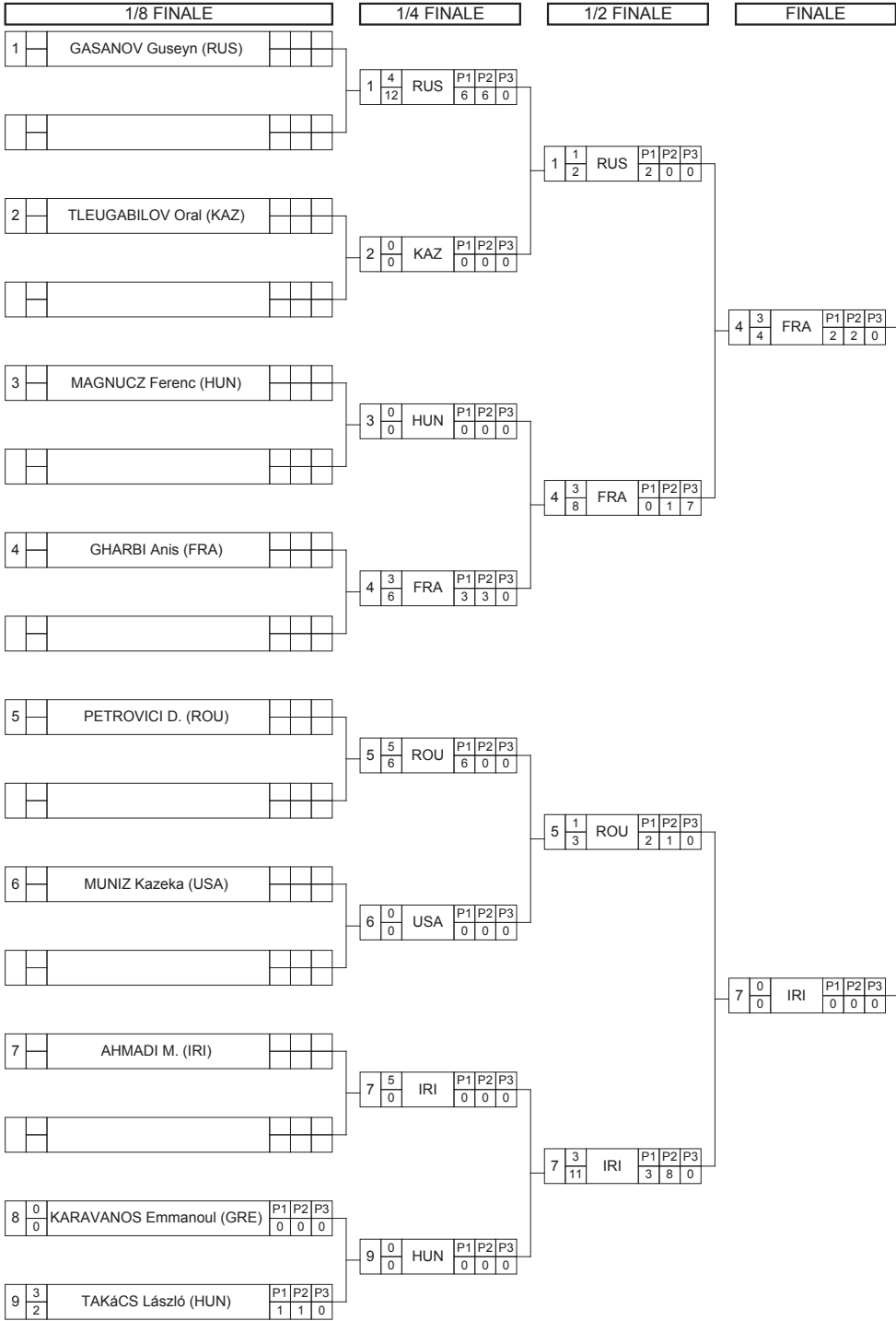

4 GHARBI Anis (FRA)

Classement

Cl	Pays	Nom
1	FRA	GHARBI Anis
2	IRI	AHMADI M.
3	HUN	MAGNUCZ Ferenc
3	ROU	PETROVICI D.
5	RUS	GASANOV Guseyn
5	HUN	TAKÁCS László
7	USA	MUNIZ Kazeka
8	GRE	KARAVANOS Emmanoul
9	KAZ	TLEUGABILOV Oral

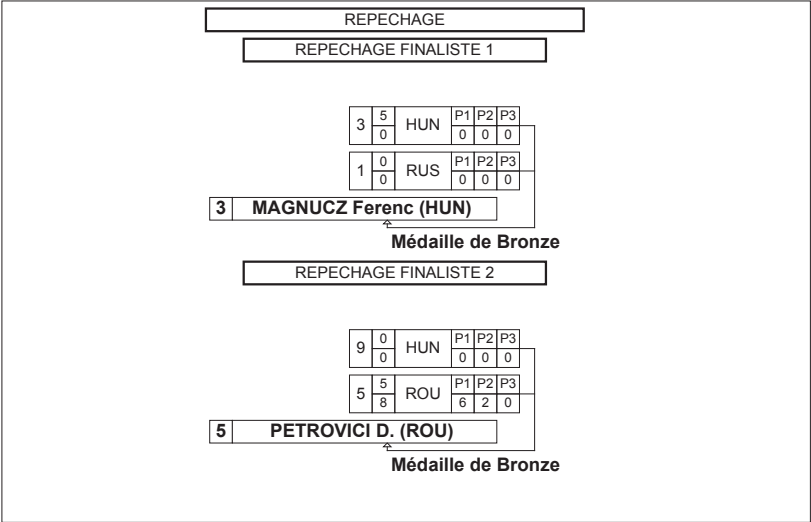



Feuille de compétition / Competition Sheet

Veteran WCH DIV A

STYLE : FS 85 kg

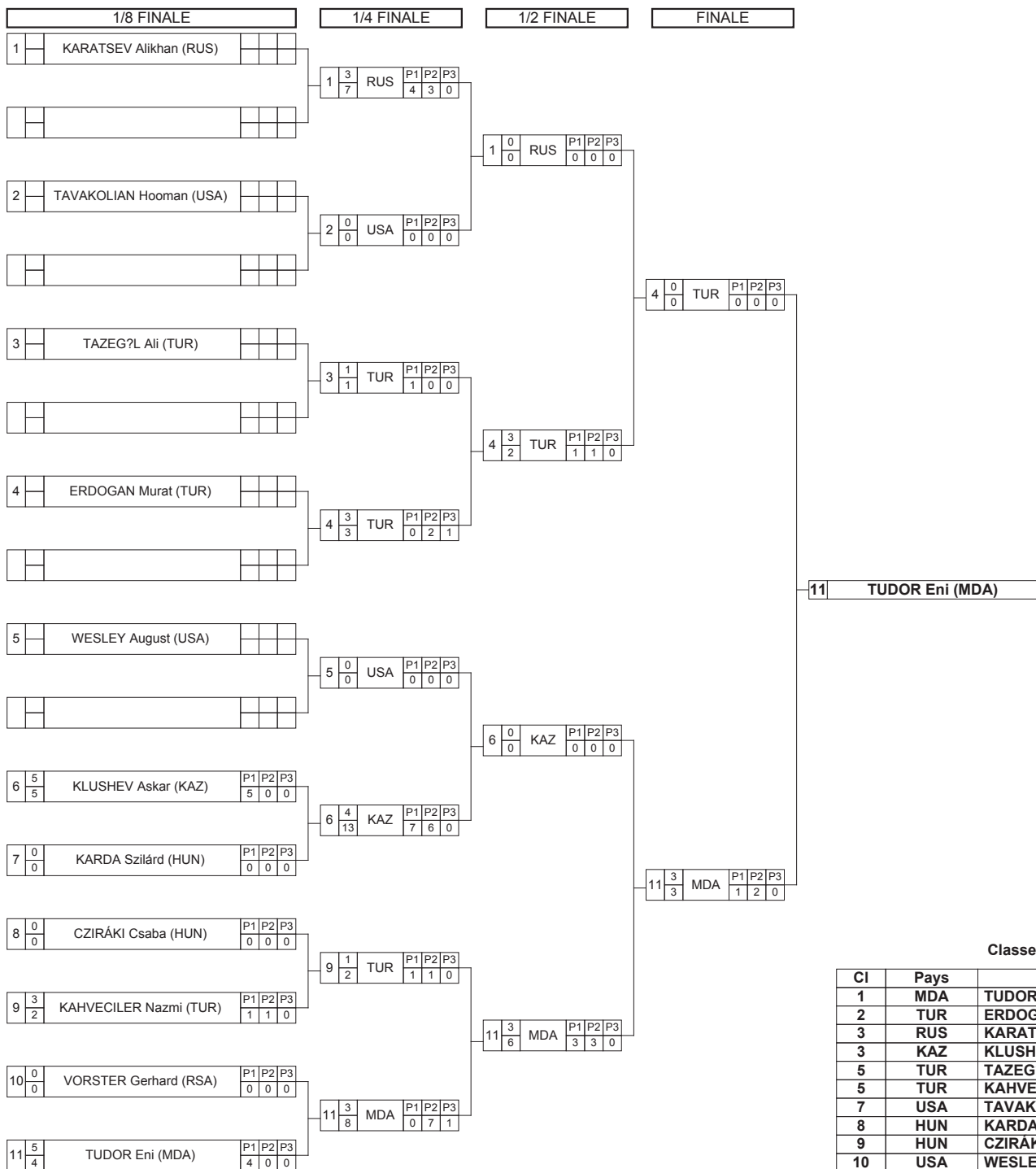

Classement

Cl	Pays	Nom
1	MDA	TUDOR Eni
2	TUR	ERDOGAN Murat
3	RUS	KARATSEV Alikhan
3	KAZ	KLUSHEV Askar
5	TUR	TAZEG?L Ali
5	TUR	KAHVECILER Nazmi
7	USA	TAVAKOLIAN Hooman
8	HUN	KARDA Szilárd
9	HUN	CZIRÁKI Csaba
10	USA	WESLEY August
11	RSA	VORSTER Gerhard

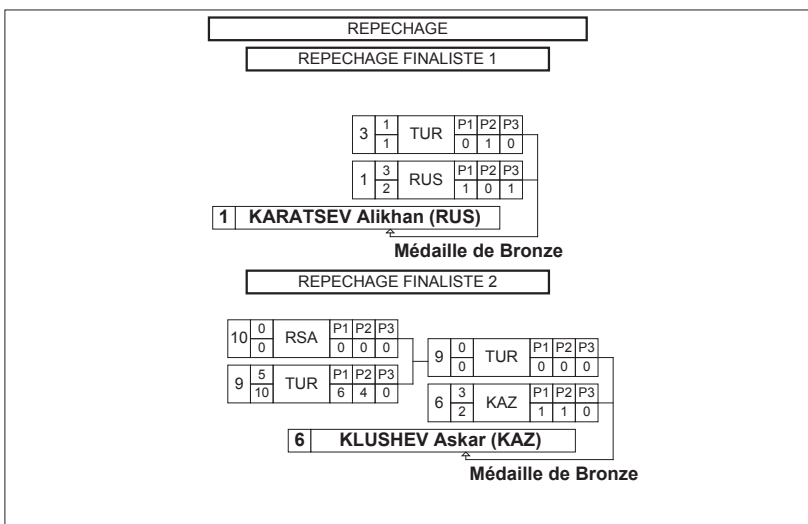



Feuille de compétition / Competition Sheet

Veteran WCH DIV A

STYLE : FS 85 kg

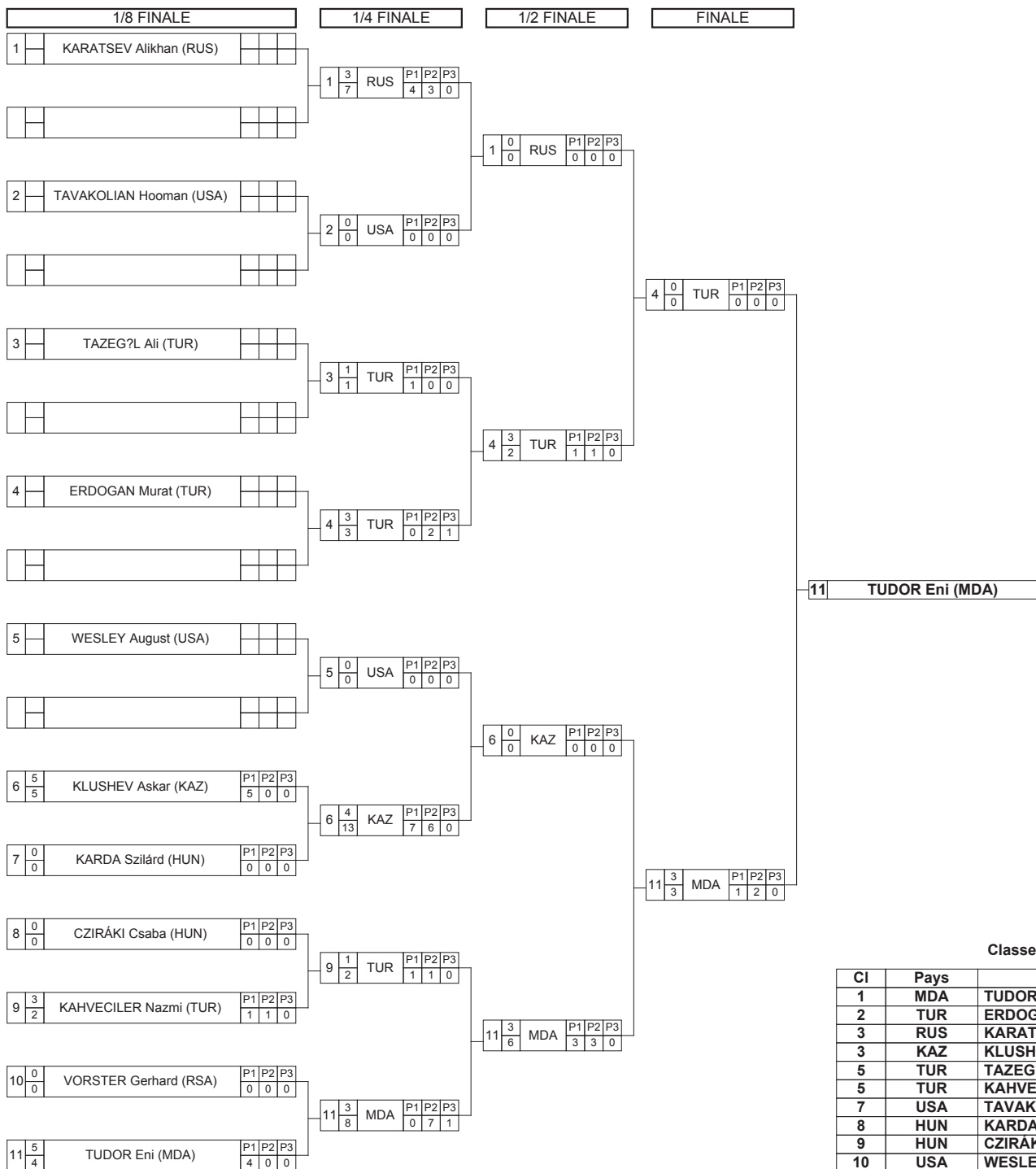

Classement

Cl	Pays	Nom
1	MDA	TUDOR Eni
2	TUR	ERDOGAN Murat
3	RUS	KARATSEV Alikhan
3	KAZ	KLUSHEV Askar
5	TUR	TAZEG?L Ali
5	TUR	KAHVECILER Nazmi
7	USA	TAVAKOLIAN Hooman
8	HUN	KARDA Szilárd
9	HUN	CZIRÁKI Csaba
10	USA	WESLEY August
11	RSA	VORSTER Gerhard

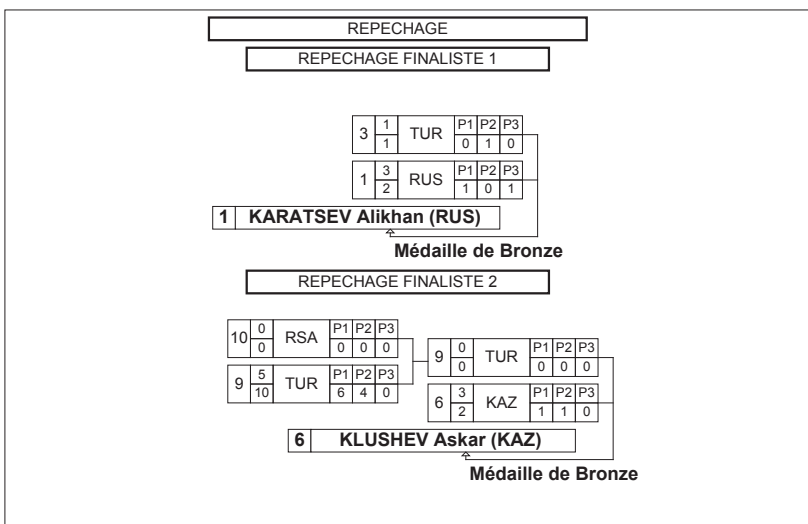



Feuille de compétition / Competition Sheet

Veteran WCH DIV A



STYLE : FS 130 kg

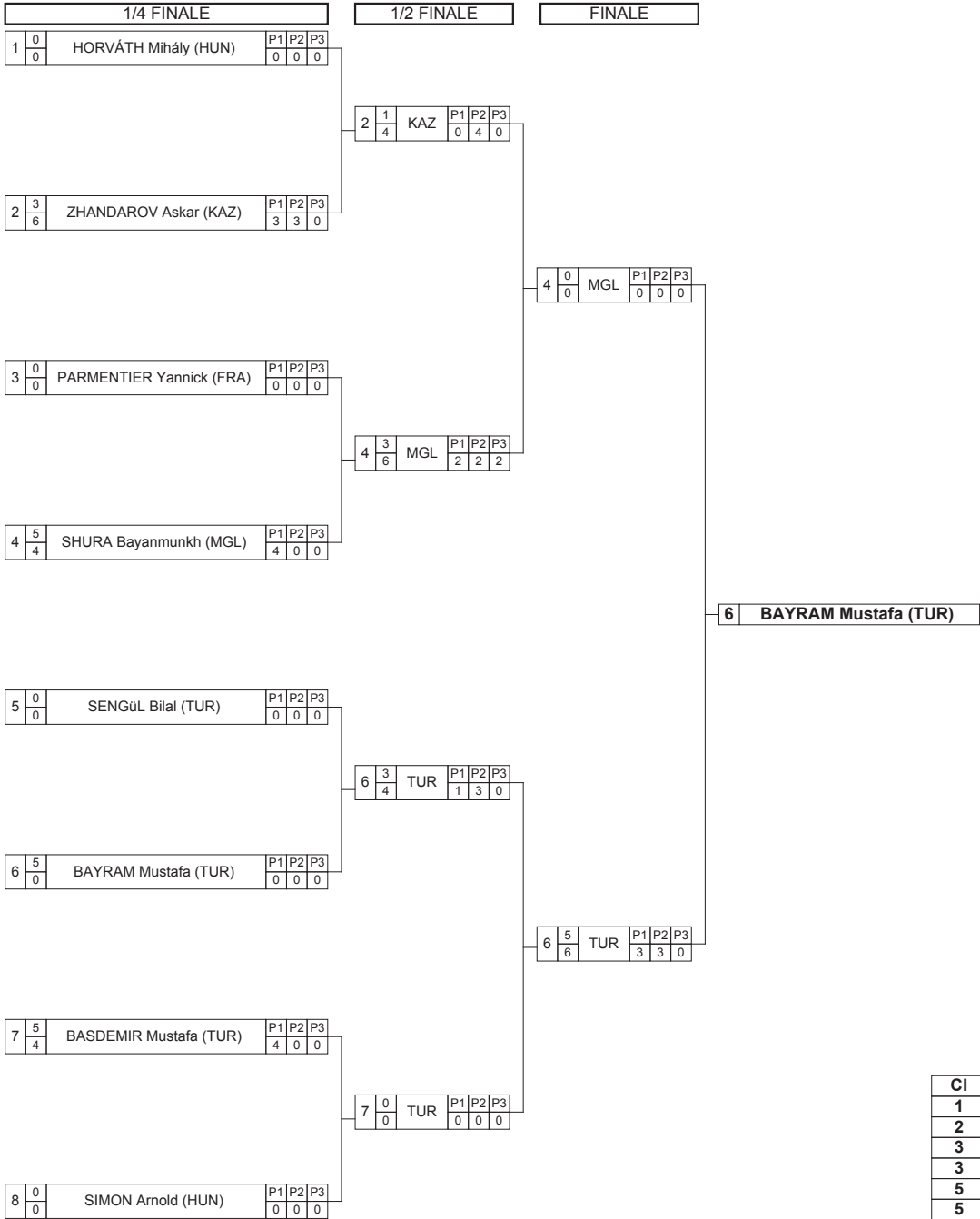

Classement

Cl	Pays	Nom
1	TUR	BAYRAM Mustafa
2	MGL	SHURA Bayanmunkh
3	KAZ	ZHANDAROV Askar
3	TUR	BASDEMİR Mustafa
5	FRA	PARMENTIER Yannick
5	TUR	SENGÜL Bilal
7	HUN	SIMON Arnold

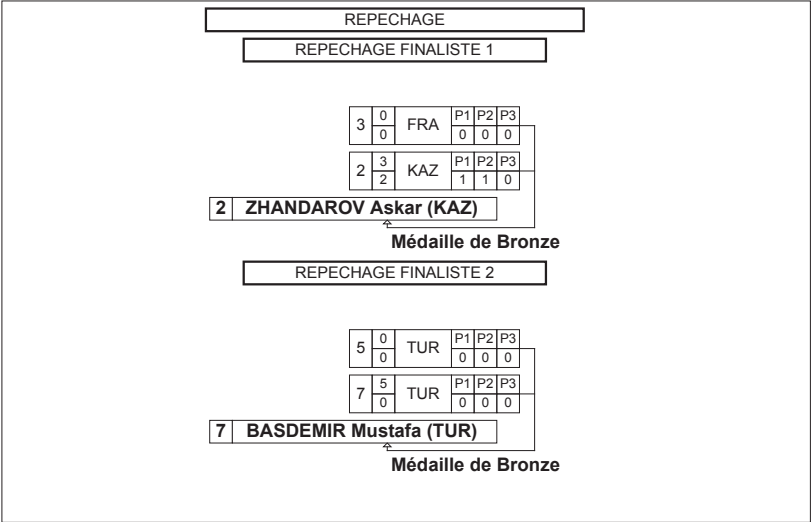



Feuille de compétition / Competition Sheet

Veteran WCH DIV B

STYLE : FS 58 kg



TOUR : 1

1	$\frac{3}{7}$	TAMÁS Zoltán (AUT)	P1	P2	P3	1	TAMÁS Zoltán (AUT)
			0	1	6		
2	$\frac{1}{3}$	RUCH Roland (SUI)	P1	P2	P3		
			2	1	0		

TOUR : 2

3	$\frac{1}{3}$	OSMAN Remzi (BUL)	P1	P2	P3	1	TAMÁS Zoltán (AUT)
			1	2	0		
1	$\frac{3}{4}$	TAMÁS Zoltán (AUT)	P1	P2	P3		
			2	2	0		

TOUR : 3

2	$\frac{0}{0}$	RUCH Roland (SUI)	P1	P2	P3	3	OSMAN Remzi (BUL)
			0	0	0		
3	$\frac{3}{10}$	OSMAN Remzi (BUL)	P1	P2	P3		
			3	7	0		

Classement

Cl	Pays	Nom	Points
1	AUT	TAMÁS Zoltán	6
2	BUL	OSMAN Remzi	4
3	SUI	RUCH Roland	1



Feuille de compétition / Competition Sheet

Veteran WCH DIV B

STYLE : FS 63 kg

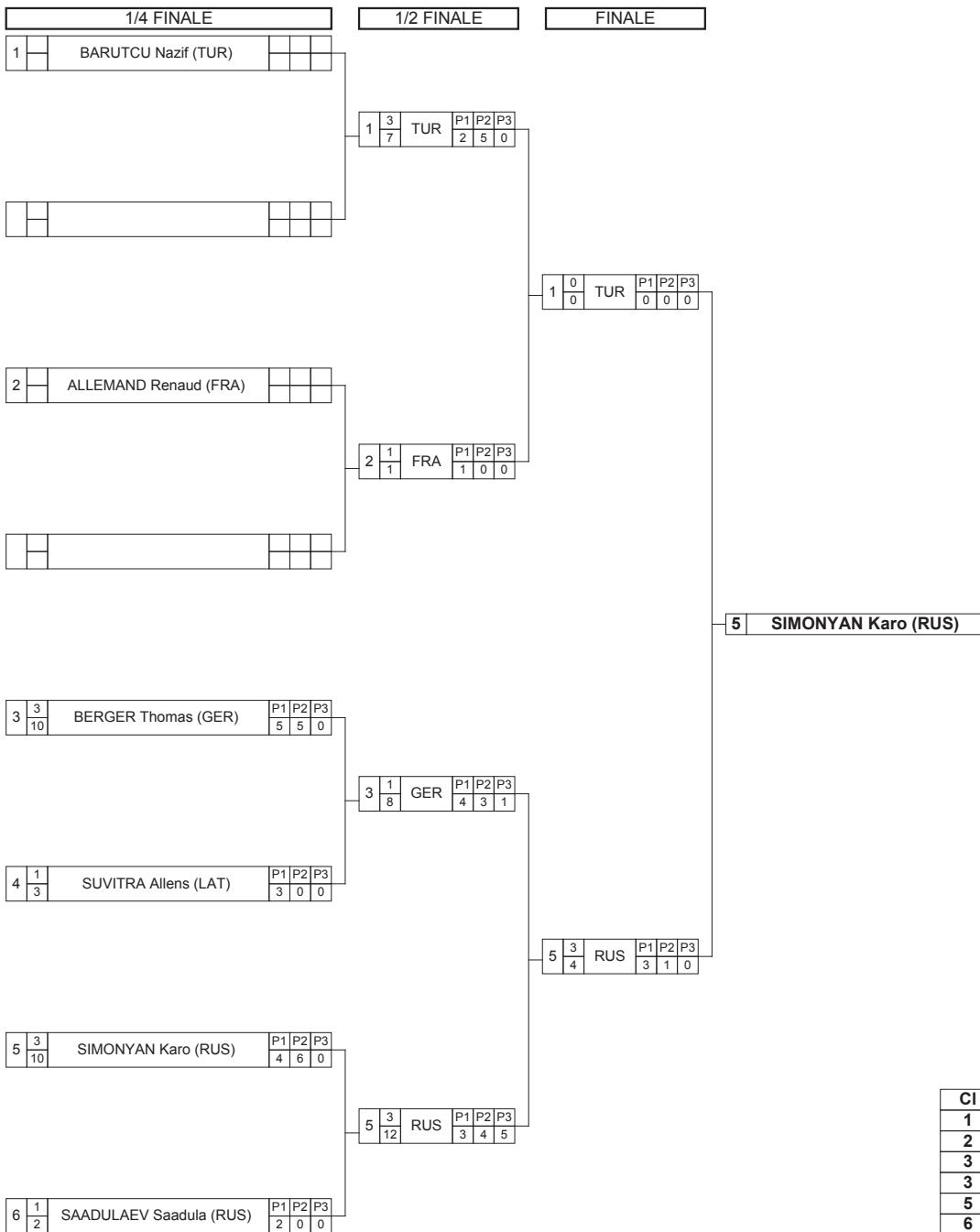
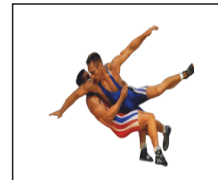

Classement

Cl	Pays	Nom
1	RUS	SIMONYAN Karo
2	TUR	BARUTCU Nazif
3	FRA	ALLEMAND Renaud
3	GER	BERGER Thomas
5	RUS	SAADULAEV Saadula
6	LAT	SUVITRA Allens

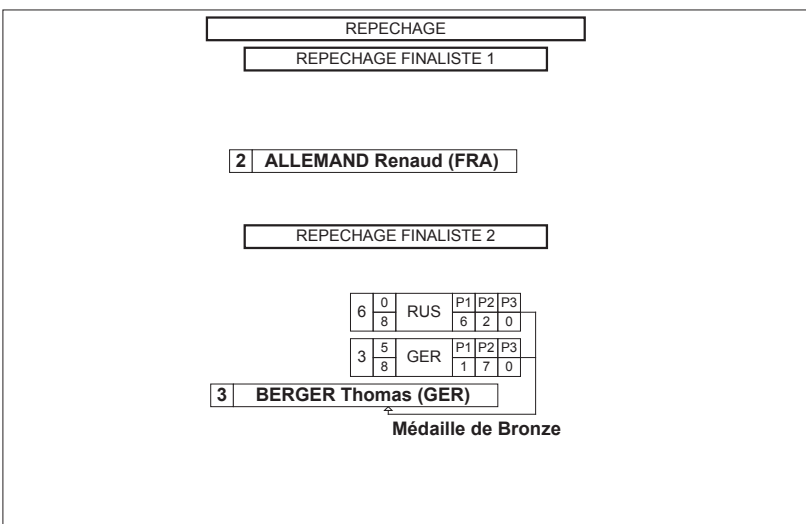



Feuille de compétition / Competition Sheet

Veteran WCH DIV B

STYLE : FS 69 kg



Classement

Cl	Pays	Nom
1	TUR	MELEK Abdulmuttalip
2	GER	BITTMANN Stefan
3	USA	CANNIZZO Dave
3	RUS	OSMANOV Abdulgalim
5	BEL	CROTT Nico
5	RUS	EVGENY Yagunov
7	KOS	OBRAZHDA Raif
8	KOS	SYLA Mustafe
9	TUR	KARACA Hayati
10	AUT	SCHUCH Dietmar
11	USA	WELCH Greg
12	ITA	CICCONOFRI Emiliano
12	MGL	KHAYANKHYARVAA N.
14	TUR	DEMİR Mahmut

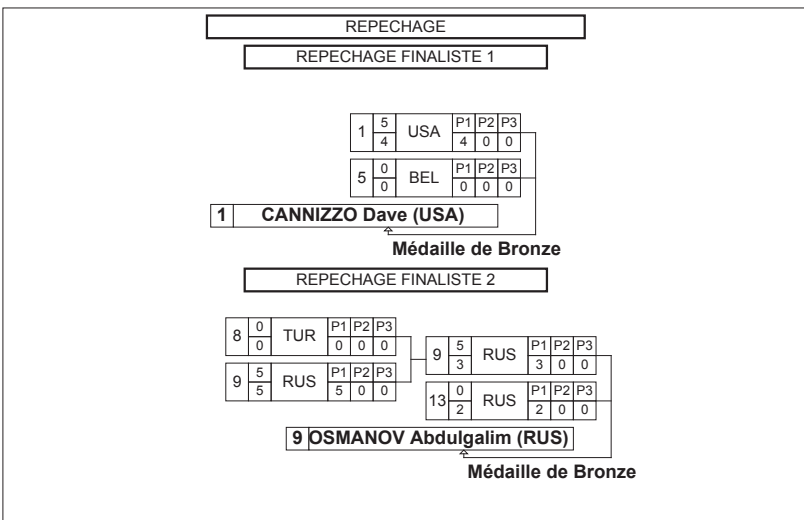



Feuille de compétition / Competition Sheet

Veteran WCH DIV B

STYLE : FS 76 kg



QUALIFICATION			1/8 FINALE			1/4 FINALE			1/2 FINALE			FINALE		
1	KARAVANOS E. (GRE)		1	0 4	GRE	P1 3	P2 1	P3 0	2	1 5	EST	P1 5	P2 0	P3 0
2	JEVSEJEV Andrei (EST)		2	5 12	EST	P1 8	P2 4	P3 0	3	1 1	USA	P1 1	P2 0	P3 0
3	PIVA Anthony (USA)		3	3 3	USA	P1 0	P2 2	P3 1	3	3 11	USA	P1 6	P2 5	P3 0
4	ELEKES Endre (HUN)		4	1 4	HUN	P1 3	P2 1	P3 0	6	0 0	IRI	P1 0	P2 0	P3 0
5	YON Gilles (FRA)		5	1 5	FRA	P1 0	P2 3	P3 2	8	3 6	SUI	P1 0	P2 1	P3 5
6	MORSHEDISAEIN S. (IRI)		6	3 9	IRI	P1 4	P2 2	P3 3	8	4 12	SUI	P1 6	P2 6	P3 0
7	CHSHERBAKOV A. (KAZ)		7	0 0	KAZ	P1 0	P2 0	P3 0	8	5 1	SUI	P1 1	P2 0	P3 0
8	FEYER Christoph (SUI)		8	5 1	SUI	P1 1	P2 0	P3 0	10	0 0	KAZ	P1 0	P2 0	P3 0
9	YILDIRIM Erkan (TUR)		9	0 0	TUR	P1 0	P2 0	P3 0	12	1 2	MDA	P1 0	P2 2	P3 0
10	KUNANBAYEV B. (KAZ)		10	5 0	KAZ	P1 0	P2 0	P3 0	12	5 5	MDA	P1 5	P2 0	P3 0
11	DARBAYEV Askar (KAZ)		11	0 0	KAZ	P1 0	P2 0	P3 0	13	3 11	TUR	P1 5	P2 6	P3 0
12	MORARU Petru (MDA)		12	5 5	MDA	P1 1	P2 4	P3 0	13	0 0	HUN	P1 0	P2 0	P3 0
13	ÖZBAS Fatih (TUR)		13	4 12	TUR	P1 6	P2 6	P3 0	13	3 6	TUR	P1 3	P2 3	P3 0
14	MOLNár József (HUN)		14	0 0	HUN	P1 0	P2 0	P3 0	18	1 1	UKR	P1 1	P2 0	P3 0
15	KALENDER Vahit (TUR)	P1 0 2 1	15	1 6	TUR	P1 0	P2 2	P3 4	18	3 9	UKR	P1 3	P2 1	P3 5
16	JOCHUM Thomas (AUT)	P1 7 0 0	18	1 1	UKR	P1 1	P2 0	P3 0						
17	SCIRANKA Marek (SVK)	P1 1 0 0												
18	SLAVOV Mykola (UKR)	P1 3 1 0												

13 ÖZBAS Fatih (TUR)

Classement

Cl	Pays	Nom
1	TUR	ÖZBAS Fatih
2	SUI	FEYER Christoph
3	IRI	MORSHEDISAEIN S.
3	MDA	MORARU Petru
5	USA	PIVA Anthony
5	UKR	SLAVOV Mykola
7	EST	JEVSEJEV Andrei
8	KAZ	KUNANBAYEV Bekbatyr
9	TUR	KALENDER Vahit
10	AUT	JOCHUM Thomas
11	FRA	YON Gilles
12	HUN	ELEKES Endre
13	SVK	SCIRANKA Marek
14	GRE	KARAVANOS Emmanouil
15	KAZ	CHSHERBAKOV A.
16	KAZ	DARBAYEV Askar
17	HUN	MOLNár József
18	TUR	YILDIRIM Erkan

REPECHAGE

REPECHAGE FINALISTE 1

7	0 0	KAZ	P1 0	P2 0	P3 0	6	5 6	IRI	P1 3	P2 3	P3 0
6	5 0	IRI	P1 0	P2 0	P3 0	3	0 3	USA	P1 3	P2 0	P3 0

6 MORSHEDISAEIN S. (IRI)

Médaille de Bronze

REPECHAGE FINALISTE 2

14	0 0	HUN	P1 0	P2 0	P3 0	18	1 3	UKR	P1 0	P2 3	P3 0
18	5 7	UKR	P1 7	P2 0	P3 0	12	3 2	MDA	P1 1	P2 0	P3 1

12 MORARU Petru (MDA)

Médaille de Bronze



Feuille de compétition / Competition Sheet

Veteran WCH DIV B

STYLE : FS 85 kg



QUALIFICATION		1/8 FINALE	1/4 FINALE	1/2 FINALE	FINALE
1	DEMIREGEN Muharrem (TUR)	1 0 0 TUR	2 1 3 AZE	4 0 0 RSA	5 5 13 USA
2	QULIYEV Islam (AZE)	2 3 2 AZE	4 3 7 RSA	5 3 10 USA	5 5 4 USA
3	BABAK HEIDARI (IRI)	3 1 3 IRI	5 5 10 USA	7 0 0 USA	9 0 0 RUS
4	DE BEER Matthys (RSA)	4 3 6 RSA	7 5 14 USA	8 0 0 UKR	9 3 6 RUS
5	SCHYCK Michael (USA)	5 5 10 USA	8 0 0 UKR	9 5 10 RUS	10 0 0 AUT
6	JANKOVICS Péter (HUN)	6 0 0 HUN	9 5 10 RUS	11 1 7 HUN	12 0 0 KAZ
7	PINE Kevin (USA)	7 5 14 USA	10 0 0 AUT	12 3 10 KAZ	13 1 1 RUS
8	ILYASOV Memet (UKR)	8 0 0 UKR	11 1 7 HUN	14 3 2 RUS	14 3 2 RUS
9	ASHYRALIEV Yaver (RUS)	9 5 10 RUS	12 0 0 KAZ	15 0 1 KULICH Borys (USA)	14 3 2 RUS
10	SCHUCH W. (AUT)	10 0 0 AUT	13 1 1 RUS	16 3 3 LUKÁCS Imre (HUN)	14 3 2 RUS
11	SIPOS Zsolt (HUN)	11 1 7 HUN	14 3 5 RUS	17 0 0 POPESCU Adrian (ROU)	14 3 2 RUS
12	BULAKH Dmitriy (KAZ)	12 3 10 KAZ	15 0 1 KULICH Borys (USA)	18 0 0 BORISOV Evgenij (LAT)	14 3 2 RUS
13	MEDZHIDOV Shokhrat (RUS)	13 1 1 RUS	16 3 5 HUN	19 5 5 SIPEKI Károly (HUN)	14 3 2 RUS
14	POGORELOV Sergey (RUS)	14 3 5 RUS	16 1 1 HUN		14 3 2 RUS
15	KULICH Borys (USA)	15 0 1 KULICH Borys (USA)			14 3 2 RUS
16	LUKÁCS Imre (HUN)	16 3 3 LUKÁCS Imre (HUN)			14 3 2 RUS
17	POPESCU Adrian (ROU)	17 0 0 POPESCU Adrian (ROU)			14 3 2 RUS
18	BORISOV Evgenij (LAT)	18 0 0 BORISOV Evgenij (LAT)			14 3 2 RUS
19	SIPEKI Károly (HUN)	19 5 5 SIPEKI Károly (HUN)			14 3 2 RUS

5 SCHYCK Michael (USA)

Classement

Cl	Pays	Nom
1	USA	SCHYCK Michael
2	RUS	POGORELOV Sergey
3	USA	PINE Kevin
3	USA	KULICH Borys
5	RSA	DE BEER Matthys
5	RUS	ASHYRALIEV Yaver
7	HUN	LUKÁCS Imre
8	HUN	SIPEKI Károly
9	AZE	QULIYEV Islam
10	KAZ	BULAKH Dmitriy
11	HUN	SIPOS Zsolt
12	IRI	BABAK HEIDARI
13	RUS	MEDZHIDOV Shokhrat
14	TUR	DEMIREGEN Muharrem
15	ROU	POPESCU Adrian
16	LAT	BORISOV Evgenij
17	AUT	SCHUCH W.
18	UKR	ILYASOV Memet
19	HUN	JANKOVICS Péter

REPECHAGE	
REPECHAGE FINALISTE 1	
6 0 0 HUN	7 3 10 USA
7 4 14 USA	4 1 1 RSA
7 PINE Kevin (USA)	
Médaille de Bronze	
REPECHAGE FINALISTE 2	
15 5 5 USA	15 3 4 USA
13 0 0 RUS	16 0 0 HUN
15 KULICH Borys (USA)	
Médaille de Bronze	



Feuille de compétition / Competition Sheet

Veteran WCH DIV B

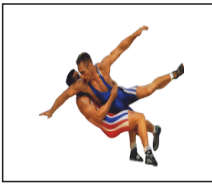

STYLE : FS 97 kg

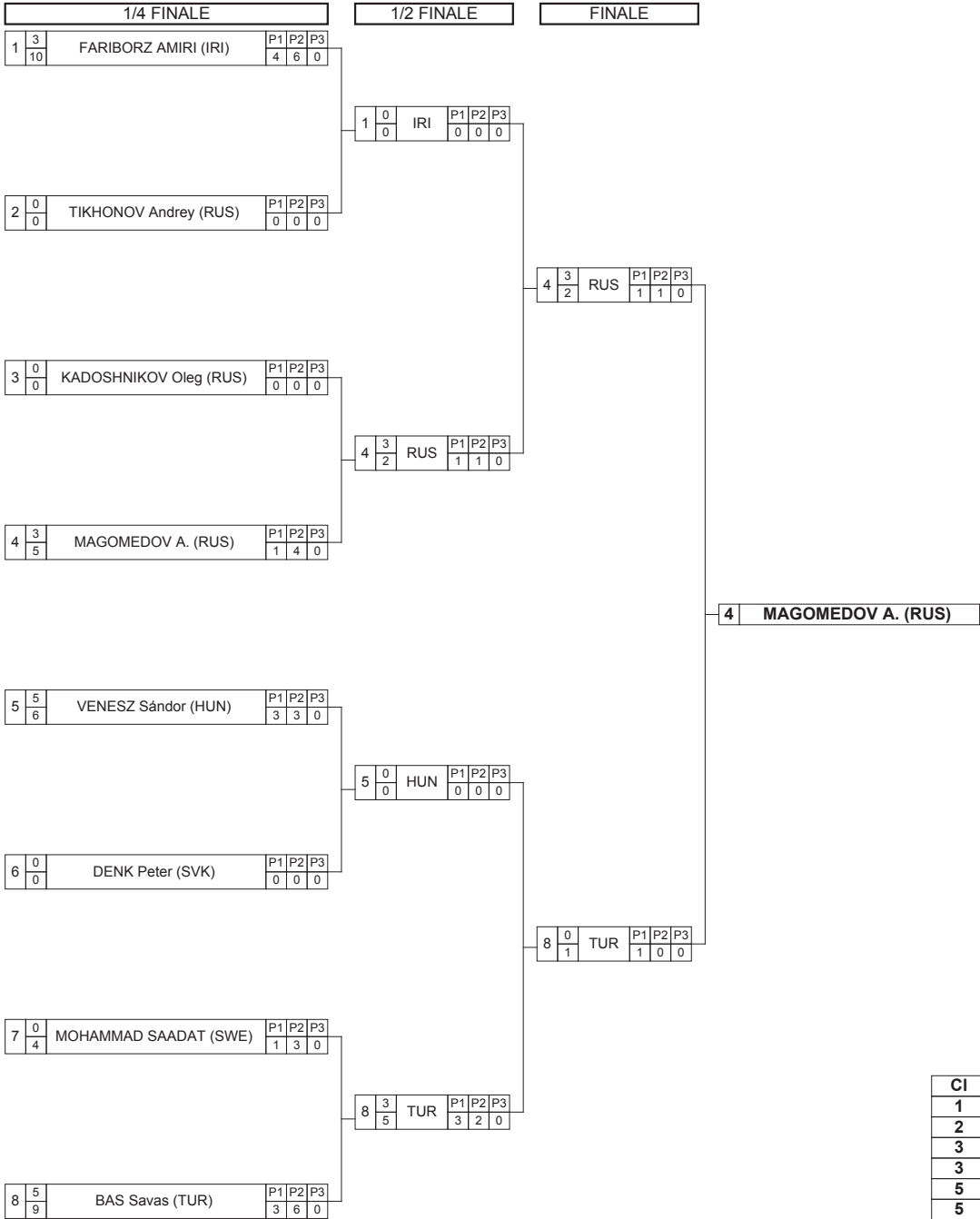

Classement

Cl	Pays	Nom
1	RUS	MAGOMEDOV A.
2	TUR	BAS Savas
3	IRI	FARIBORZ AMIRI
3	HUN	VENESZ Sándor
5	RUS	KADOSHNIKOV Oleg
5	SWE	MOHAMMAD SAADAT
7	SVK	DENK Peter
8	RUS	TIKHONOV Andrey

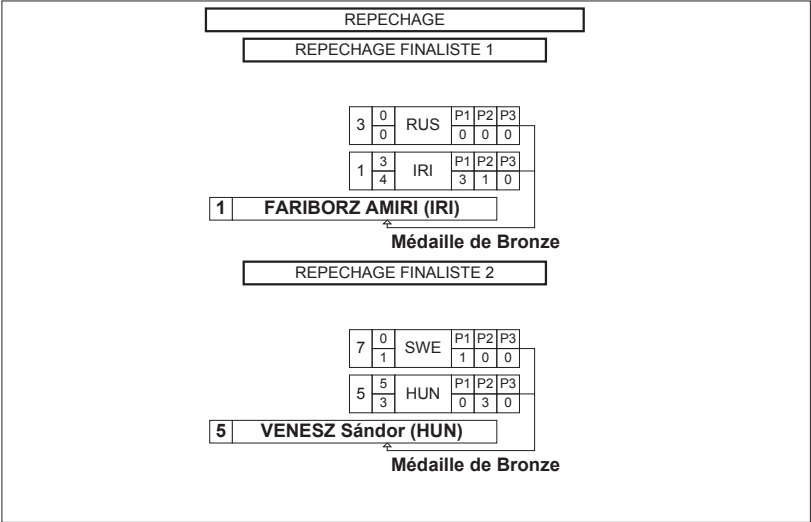



Feuille de compétition / Competition Sheet

Veteran WCH DIV B

STYLE : FS 130 kg

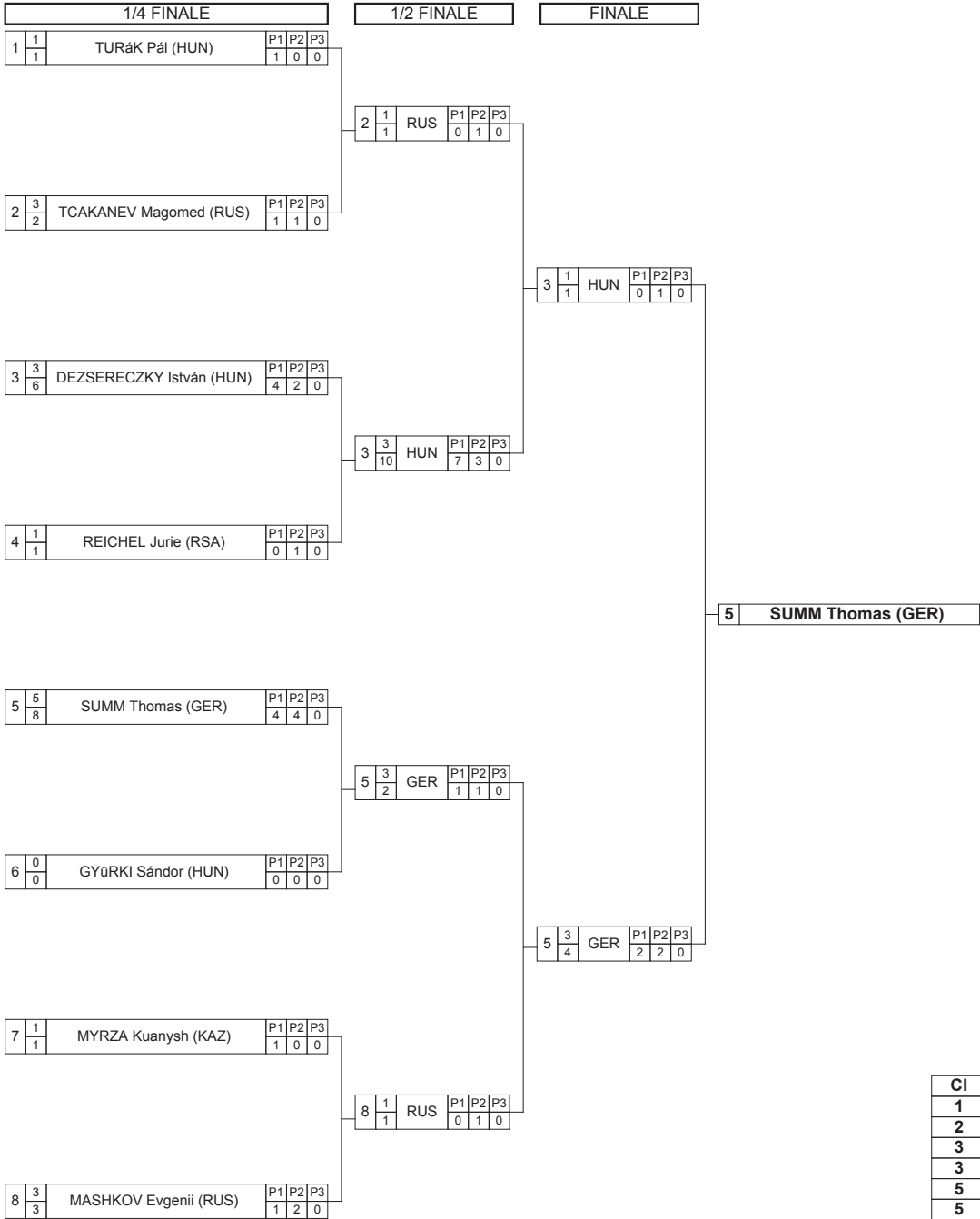
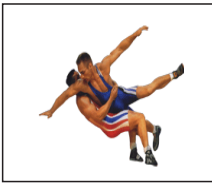

Classement

Cl	Pays	Nom
1	GER	SUMM Thomas
2	HUN	DEZSERECZKY István
3	RSA	REICHEL Jurie
3	RUS	MASHKOV Evgenii
5	RUS	TCAKANEV Magomed
5	HUN	GYÜRKI Sándor
7	HUN	TURÁK Pál
8	KAZ	MYRZA Kuanysh

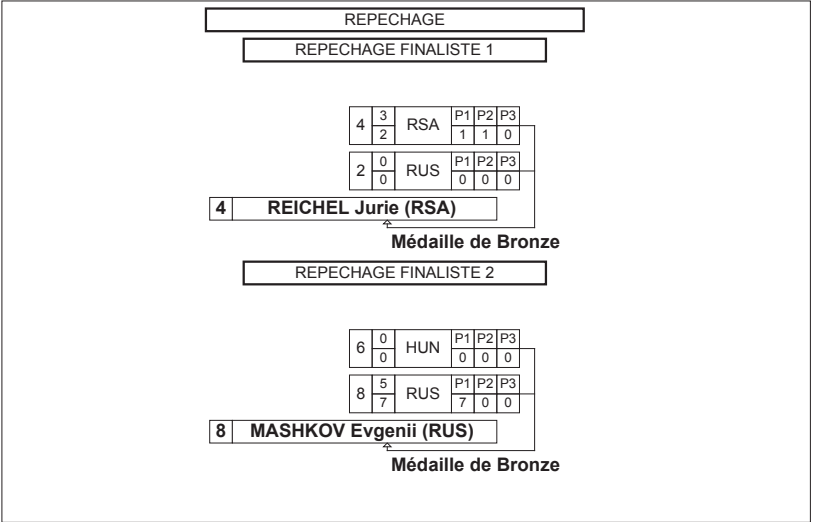



Feuille de compétition / Competition Sheet

Veteran WCH DIV C

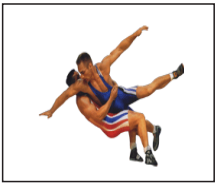

STYLE : FS 58 kg

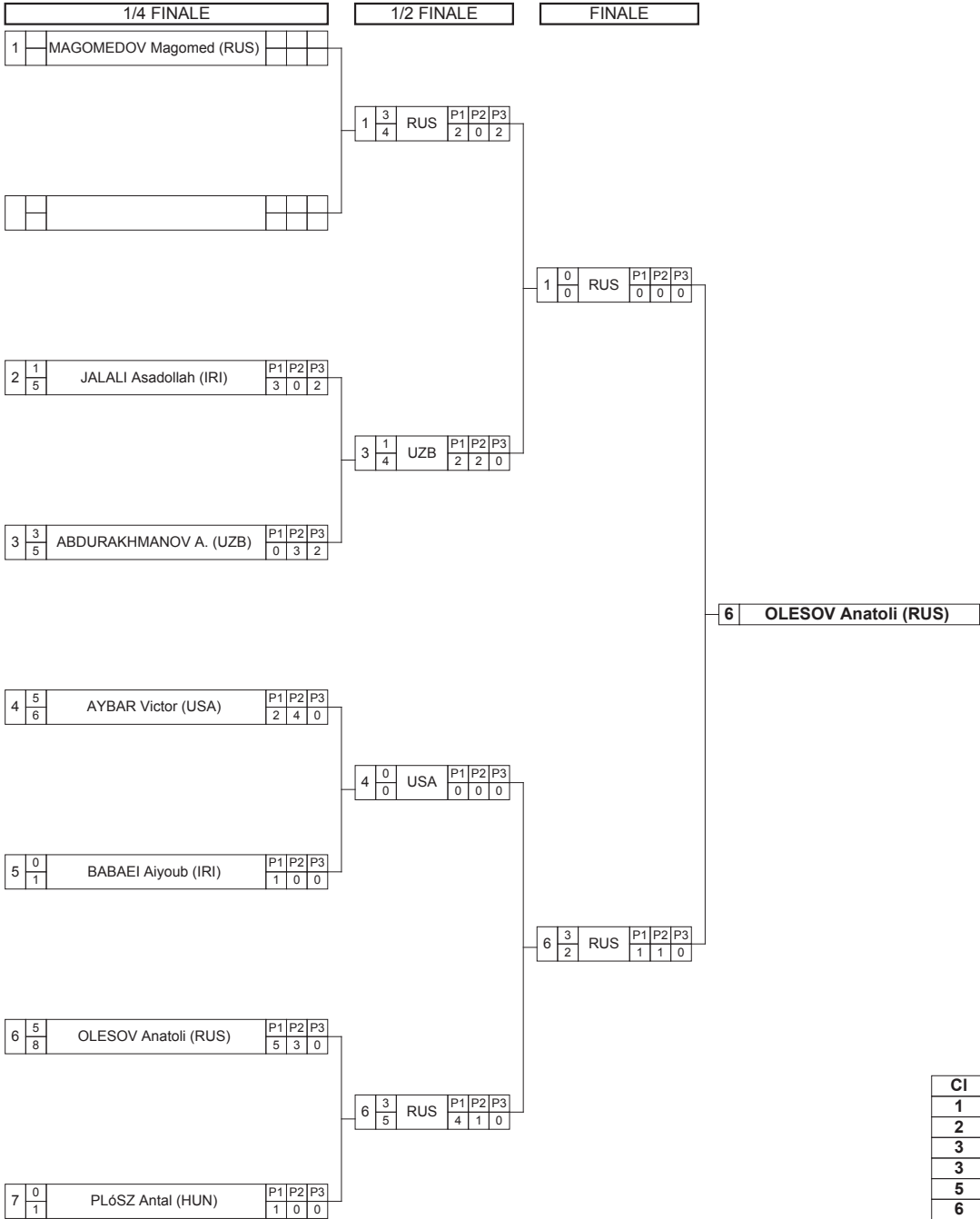

Classement

Cl	Pays	Nom
1	RUS	OLESOV Anatoli
2	RUS	MAGOMEDOV Magomed
3	UZB	ABDURAKHMANOV A.
3	USA	AYBAR Victor
5	HUN	PL6SZ Antal
6	IRI	JALALI Asadollah
7	IRI	BABAEI Aiyoub

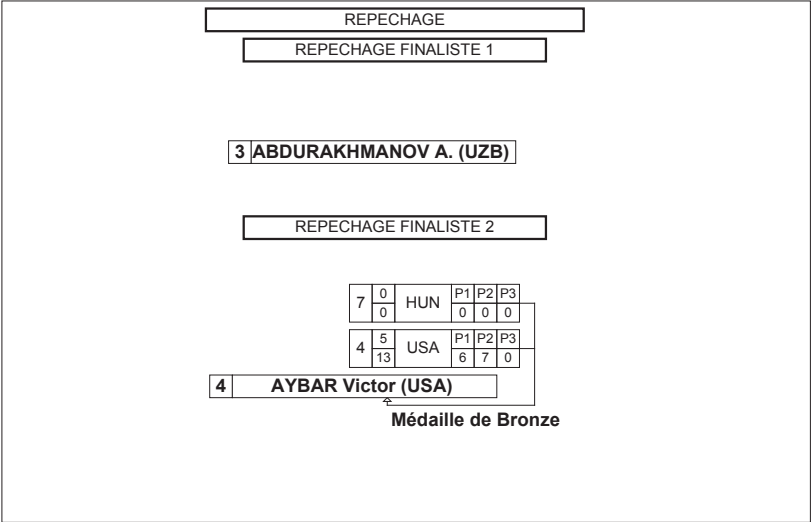



Feuille de compétition / Competition Sheet

Veteran WCH DIV C

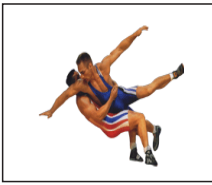

STYLE : FS 63 kg

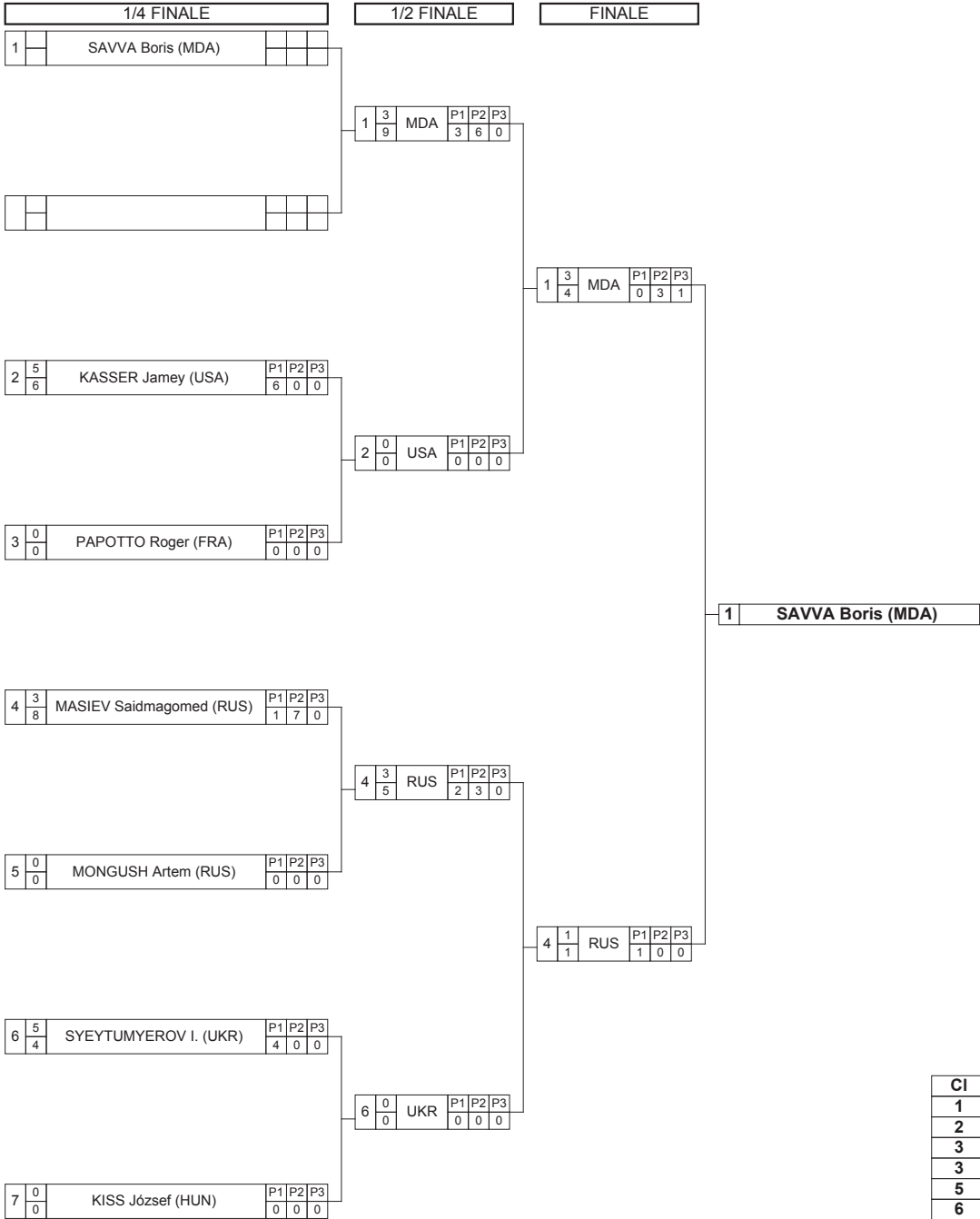

Classement

Cl	Pays	Nom
1	MDA	SAVVA Boris
2	RUS	MASIEV Saidmagomed
3	USA	KASSER Jamey
3	UKR	SYEYTUMYEROV I.
5	RUS	MONGUSH Artem
6	HUN	KISS József
7	FRA	PAPOTTO Roger

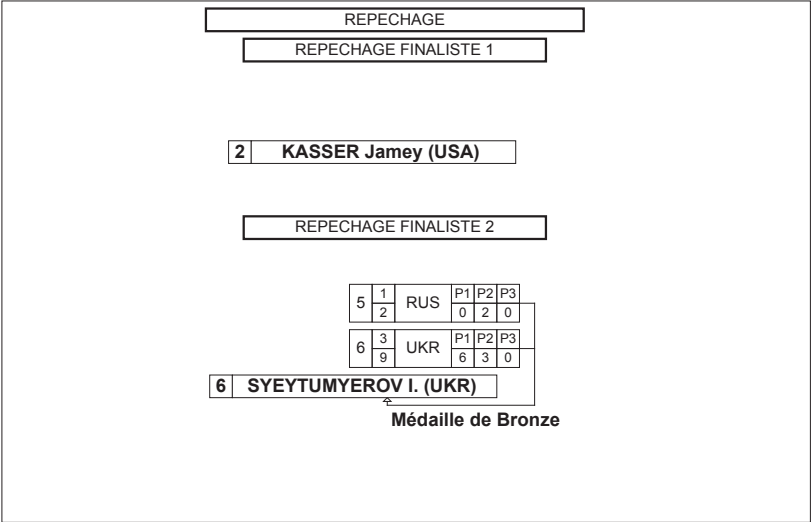



Feuille de compétition / Competition Sheet

Veteran WCH DIV C

STYLE : FS 69 kg

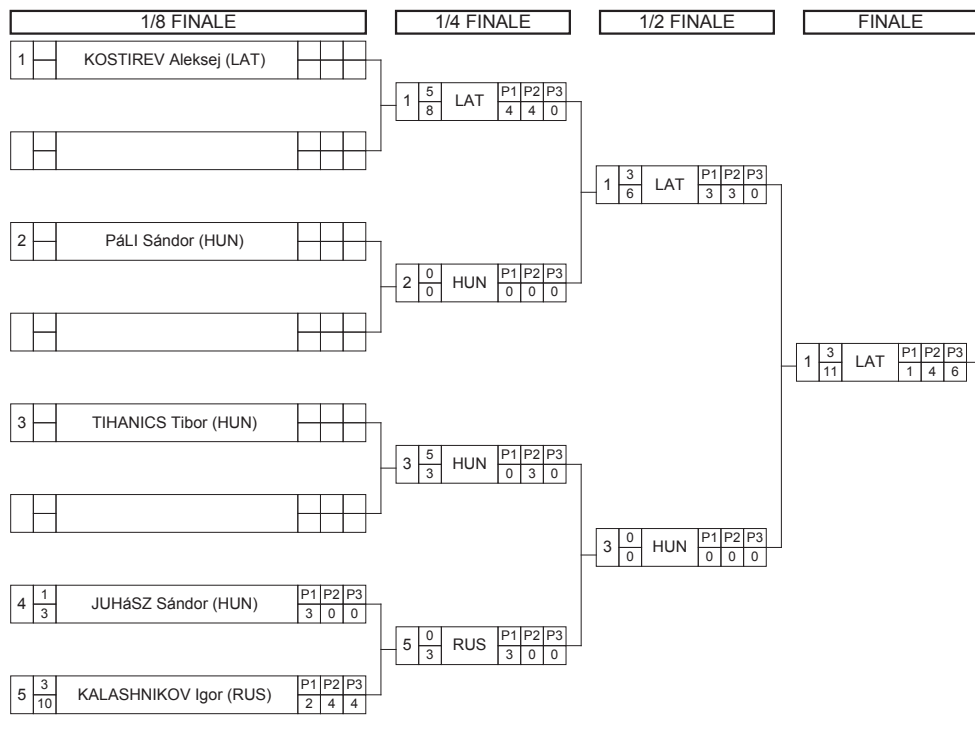

1 KOSTIREV Aleksej (LAT)

Classement

Cl	Pays	Nom
1	LAT	KOSTIREV Aleksej
2	TUR	ERTEN Zekayi
3	HUN	TIHANICS Tibor
3	RUS	KOGOTYZHEV Muaed
5	HUN	PÁLI Sándor
5	HUN	RÉVFI Tibor
7	ITA	MAINARDI Fabrizio
8	SUI	LEHMANN Gottlieb
9	RUS	KALASHNIKOV Igor
10	HUN	JUHÁSZ Sándor
11	USA	HINES David
12	KAZ	UTEPPERGENOV N.
13	GER	FRITSCHÉ Olaf

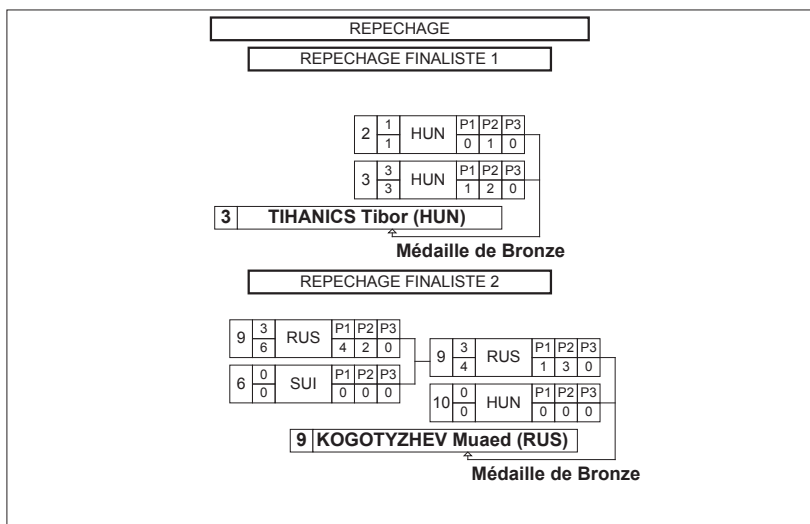



Feuille de compétition / Competition Sheet

Veteran WCH DIV C

STYLE : FS 76 kg

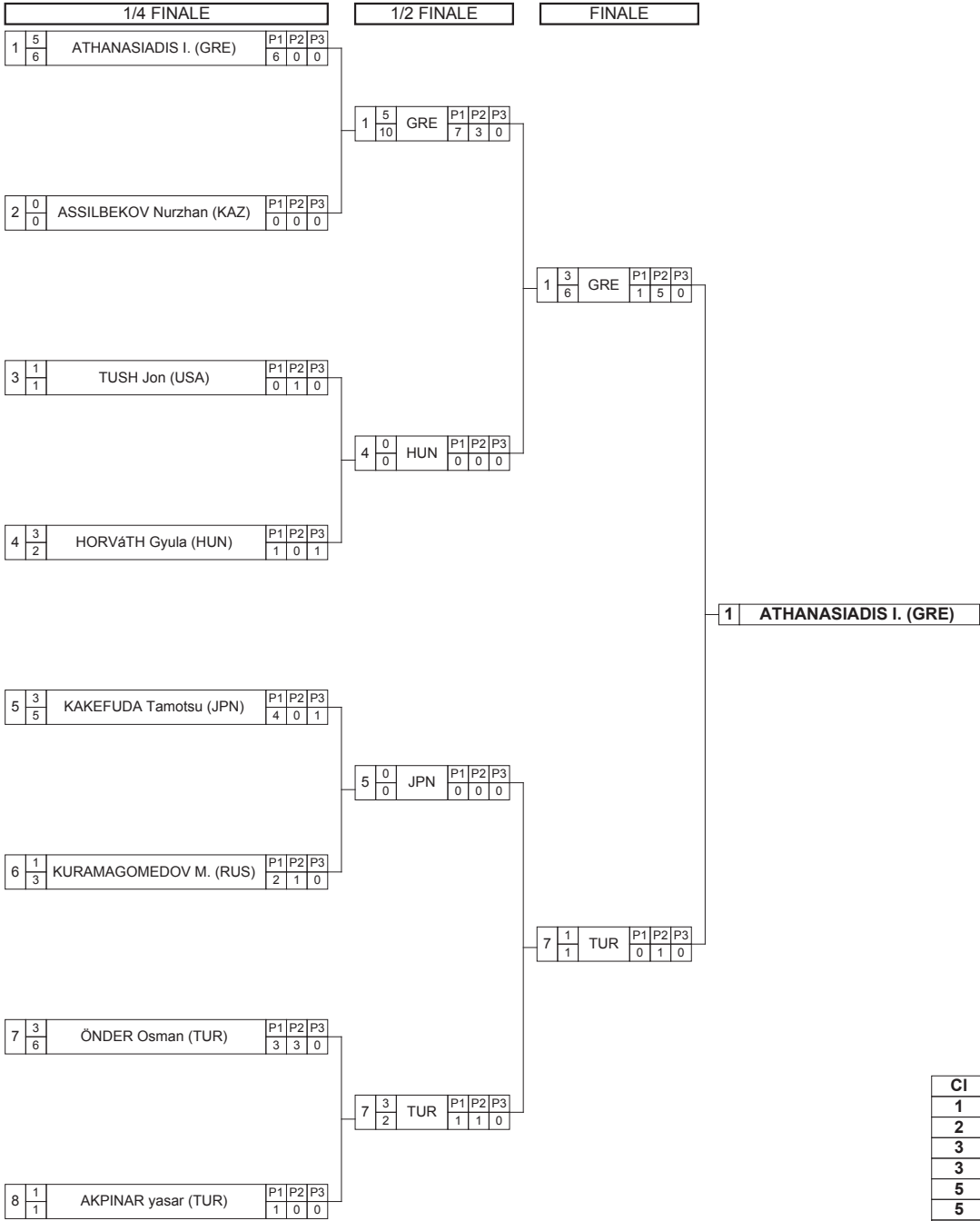
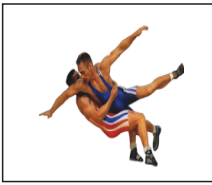

Classement

Cl	Pays	Nom
1	GRE	ATHANASIADIS I.
2	TUR	ÖNDER Osman
3	KAZ	ASSILBEKOV Nurzhan
3	JPN	KAKEFUDA Tamotsu
5	HUN	HORVÁTH Gyula
5	TUR	AKPINAR yasar
7	RUS	KURAMAGOMEDOV M.
8	USA	TUSH Jon

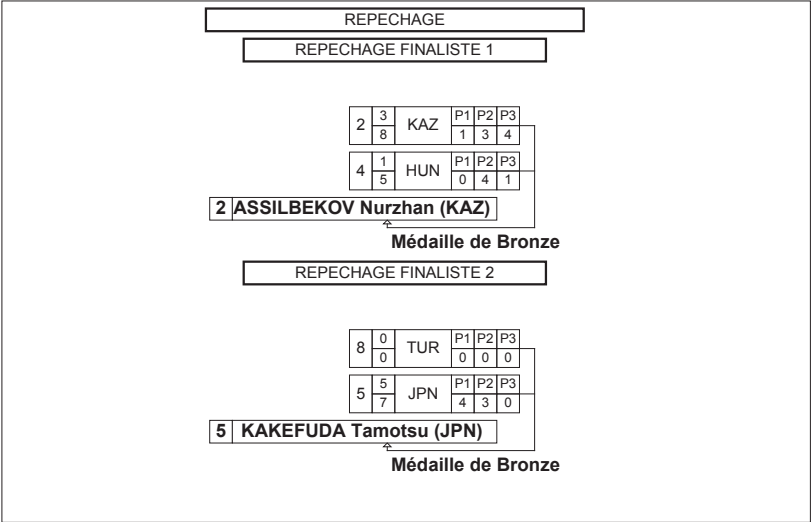



Feuille de compétition / Competition Sheet

Veteran WCH DIV C



STYLE : FS 85 kg

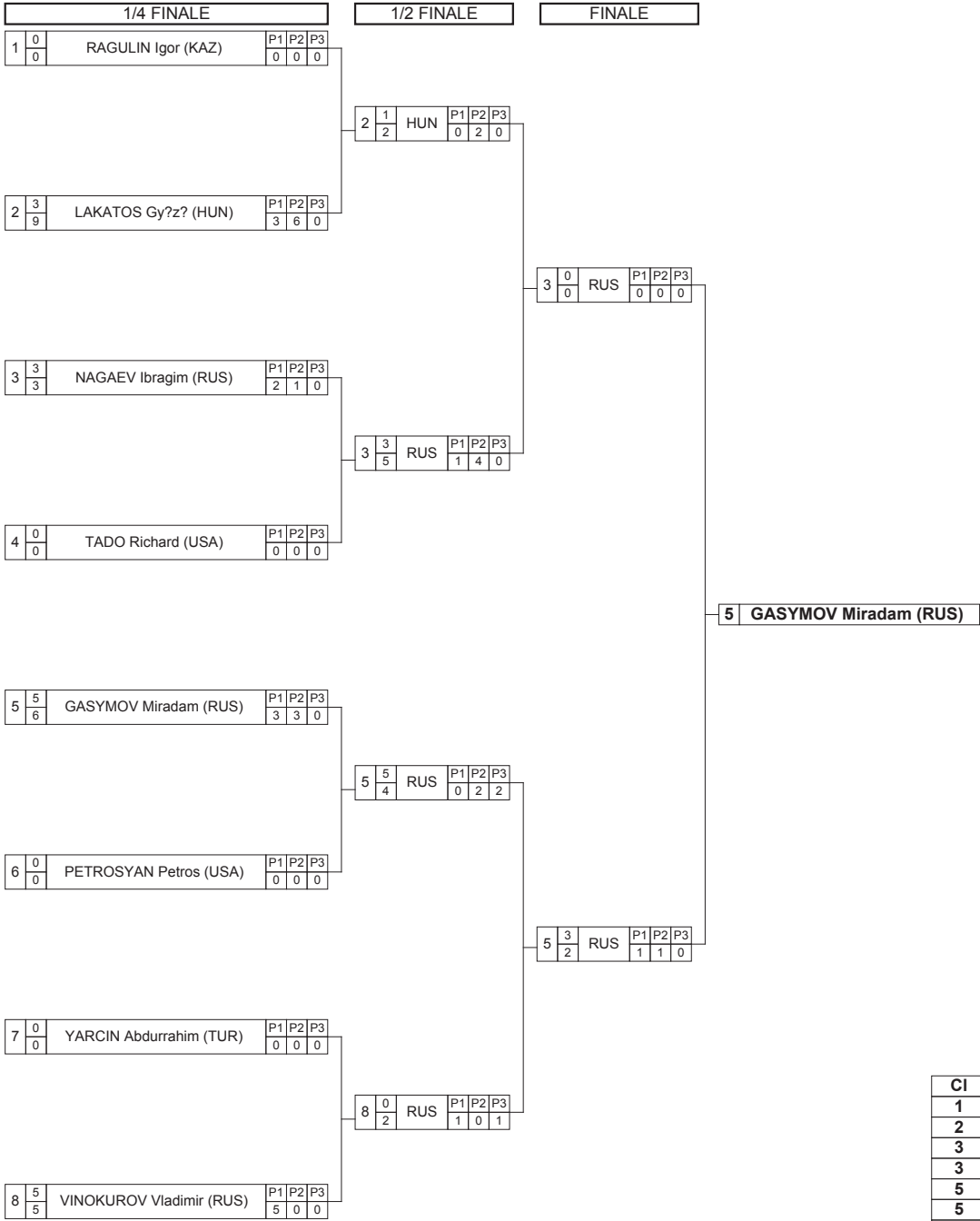

Classement

Cl	Pays	Nom
1	RUS	GASYMOV Miradam
2	RUS	NAGAEV Ibragim
3	HUN	LAKATOS Gy?z?
3	RUS	VINOKUROV Vladimir
5	USA	TADO Richard
5	USA	PETROSYAN Petros
7	TUR	YARCIN Abdurrahim
8	KAZ	RAGULIN Igor

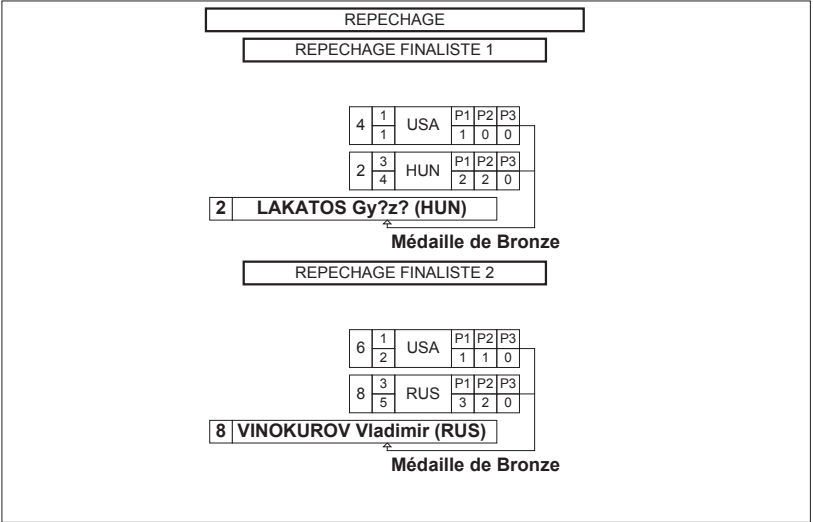



Feuille de compétition / Competition Sheet

Veteran WCH DIV C

STYLE : FS 97 kg

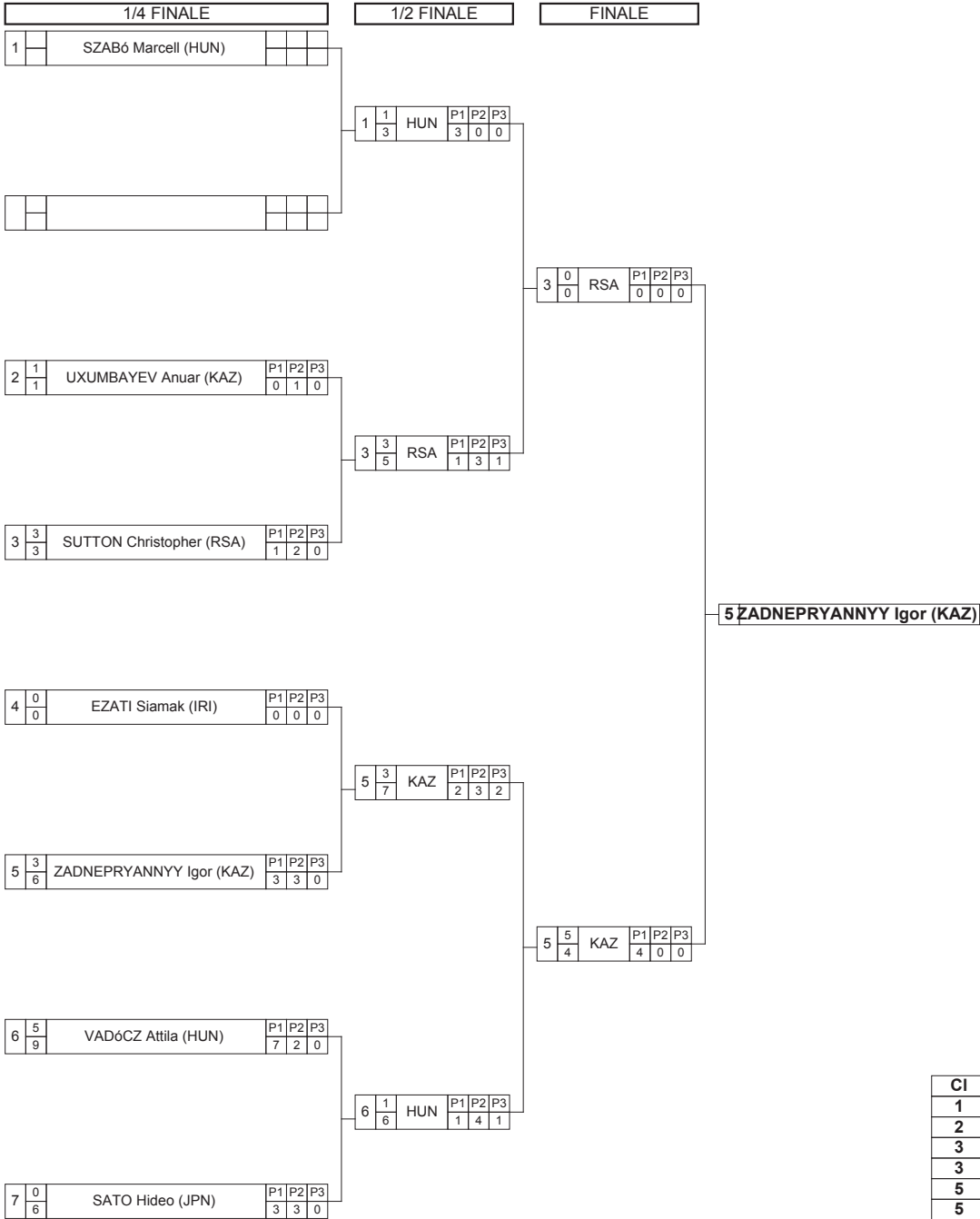
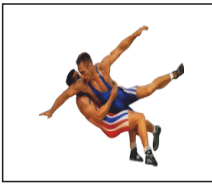

Classement

Cl	Pays	Nom
1	KAZ	ZADNEPRYANNYY Igor
2	RSA	SUTTON Christopher
3	KAZ	UXUMBAYEV Anuar
3	HUN	VADóCZ Attila
5	HUN	SZABó Marcell
5	IRI	EZATI Siamak
7	JPN	SATO Hideo

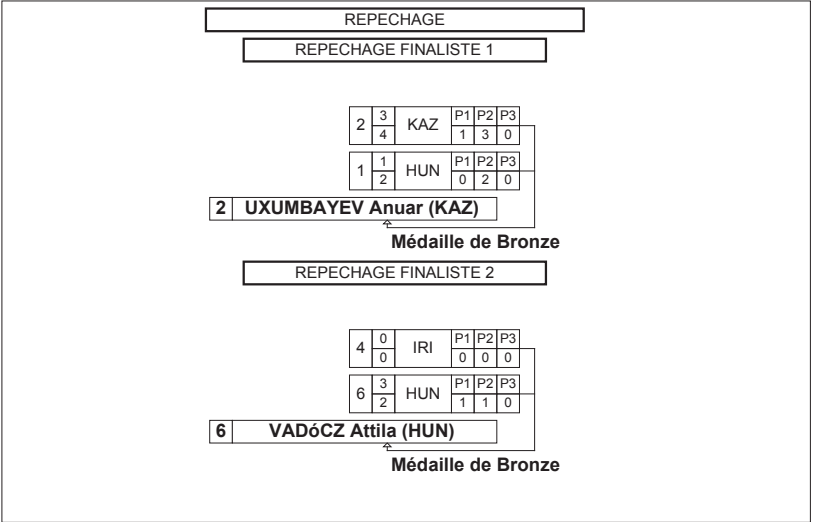



Feuille de compétition / Competition Sheet

Veteran WCH DIV C

STYLE : FS 130 kg

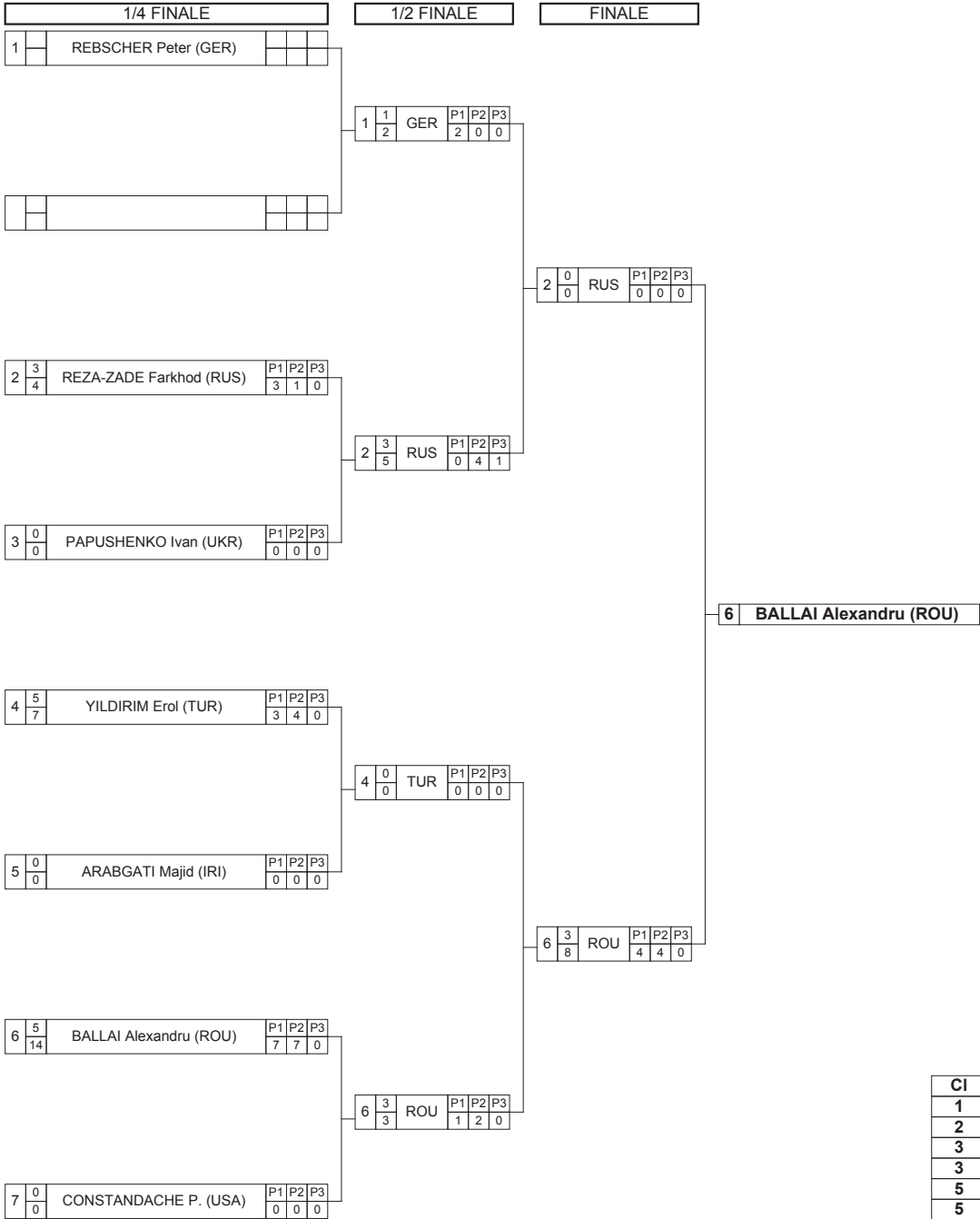
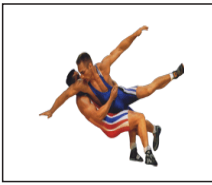

Classement

Cl	Pays	Nom
1	ROU	BALLAI Alexandru
2	RUS	REZA-ZADE Farkhod
3	GER	REBSCHER Peter
3	TUR	YILDIRIM Erol
5	UKR	PAPUSHENKO Ivan
5	USA	CONSTANDACHE P.
7	IRI	ARABGATI Majid

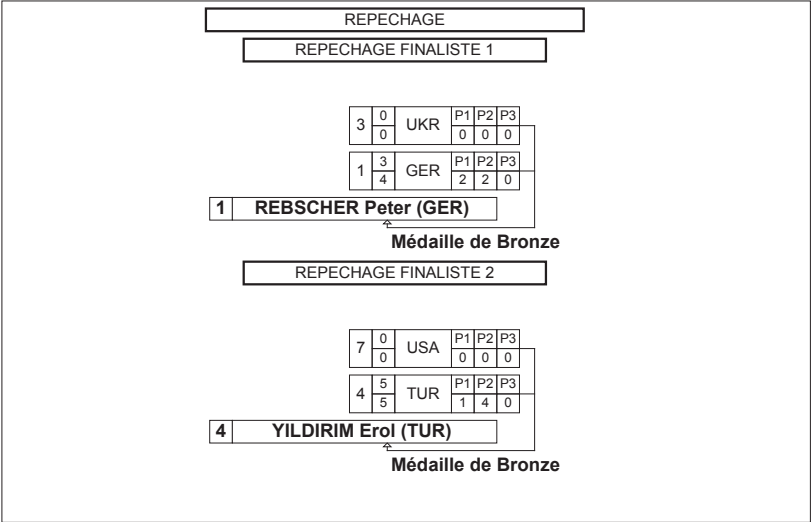



Feuille de compétition / Competition Sheet

Veteran WCH DIV D

STYLE : FS 58 kg



TOUR : 1

1	0 0	HORTON R. (USA)	P1 0	P2 0	P3 0	2	HOVHANNISYAN Zhora (ARM)
2	4 8	HOVHANNISYAN Zhora (ARM)	P1 8	P2 0	P3 0		
3	0 0	KAZIMOGLU Muhlis (TUR)	P1 0	P2 0	P3 0	4	HASHIURA Susumu (JPN)
4	3 6	HASHIURA Susumu (JPN)	P1 4	P2 2	P3 0		

TOUR : 2

1	0 0	HORTON R. (USA)	P1 0	P2 0	P3 0	3	KAZIMOGLU Muhlis (TUR)
3	4 4	KAZIMOGLU Muhlis (TUR)	P1 4	P2 0	P3 0		
2	3 6	HOVHANNISYAN Zhora (ARM)	P1 3	P2 3	P3 0	2	HOVHANNISYAN Zhora (ARM)
4	1 1	HASHIURA Susumu (JPN)	P1 0	P2 1	P3 0		

TOUR : 3

1	0 0	HORTON R. (USA)	P1 0	P2 0	P3 0	4	HASHIURA Susumu (JPN)
4	4 6	HASHIURA Susumu (JPN)	P1 6	P2 0	P3 0		
2	3 11	HOVHANNISYAN Zhora (ARM)	P1 5	P2 6	P3 0	2	HOVHANNISYAN Zhora (ARM)
3	0 0	KAZIMOGLU Muhlis (TUR)	P1 0	P2 0	P3 0		

Classement

Cl	Pays	Nom	Points
1	ARM	HOVHANNISYAN Zhora	10
2	JPN	HASHIURA Susumu	8
3	TUR	KAZIMOGLU Muhlis	4
4	USA	HORTON R.	0



Feuille de compétition / Competition Sheet

Veteran WCH DIV D

STYLE : FS 63 kg



TOUR : 1

1	$\frac{1}{4}$	TEMBOTOV Anatolii (RUS)	P1	P2	P3	2	TOJUMOV Shamil (BEL)
			0	4	0		
2	$\frac{3}{6}$	TOJUMOV Shamil (BEL)	P1	P2	P3		
			3	0	3		
3	$\frac{3}{3}$	FATAHI Khirolah (IRI)	P1	P2	P3	3	FATAHI Khirolah (IRI)
			0	2	1		
4	$\frac{1}{1}$	ADZIEV Ruslan (RUS)	P1	P2	P3		
			1	0	0		

TOUR : 2

5	$\frac{3}{9}$	POPOV Ruslan (RUS)	P1	P2	P3	5	POPOV Ruslan (RUS)
			0	6	3		
1	$\frac{1}{13}$	TEMBOTOV Anatolii (RUS)	P1	P2	P3		
			8	3	2		
2	$\frac{0}{0}$	TOJUMOV Shamil (BEL)	P1	P2	P3	3	FATAHI Khirolah (IRI)
			0	0	0		
3	$\frac{3}{8}$	FATAHI Khirolah (IRI)	P1	P2	P3		
			4	4	0		

TOUR : 3

4	$\frac{5}{0}$	ADZIEV Ruslan (RUS)	P1	P2	P3	4	ADZIEV Ruslan (RUS)
			0	0	0		
1	$\frac{0}{0}$	TEMBOTOV Anatolii (RUS)	P1	P2	P3		
			0	0	0		
5	$\frac{0}{0}$	POPOV Ruslan (RUS)	P1	P2	P3	2	TOJUMOV Shamil (BEL)
			0	0	0		
2	$\frac{4}{3}$	TOJUMOV Shamil (BEL)	P1	P2	P3		
			3	0	0		

TOUR : 4

3	$\frac{4}{0}$	FATAHI Khirolah (IRI)	P1	P2	P3	3	FATAHI Khirolah (IRI)
			0	0	0		
1	$\frac{0}{0}$	TEMBOTOV Anatolii (RUS)	P1	P2	P3		
			0	0	0		
4	$\frac{4}{7}$	ADZIEV Ruslan (RUS)	P1	P2	P3	4	ADZIEV Ruslan (RUS)
			4	3	0		
5	$\frac{0}{0}$	POPOV Ruslan (RUS)	P1	P2	P3		
			0	0	0		

TOUR : 5

2	$\frac{3}{9}$	TOJUMOV Shamil (BEL)	P1	P2	P3	2	TOJUMOV Shamil (BEL)
			3	3	3		
4	$\frac{1}{5}$	ADZIEV Ruslan (RUS)	P1	P2	P3		
			1	3	1		
3	$\frac{4}{4}$	FATAHI Khirolah (IRI)	P1	P2	P3	3	FATAHI Khirolah (IRI)
			4	0	0		
5	$\frac{0}{0}$	POPOV Ruslan (RUS)	P1	P2	P3		
			0	0	0		

Classement

Cl	Pays	Nom	Points
1	IRI	FATAHI Khirolah	14
2	RUS	ADZIEV Ruslan	11
3	BEL	TOJUMOV Shamil	10
4	RUS	POPOV Ruslan	3
5	RUS	TEMBOTOV Anatolii	2



Feuille de compétition / Competition Sheet

Veteran WCH DIV D

STYLE : FS 69 kg

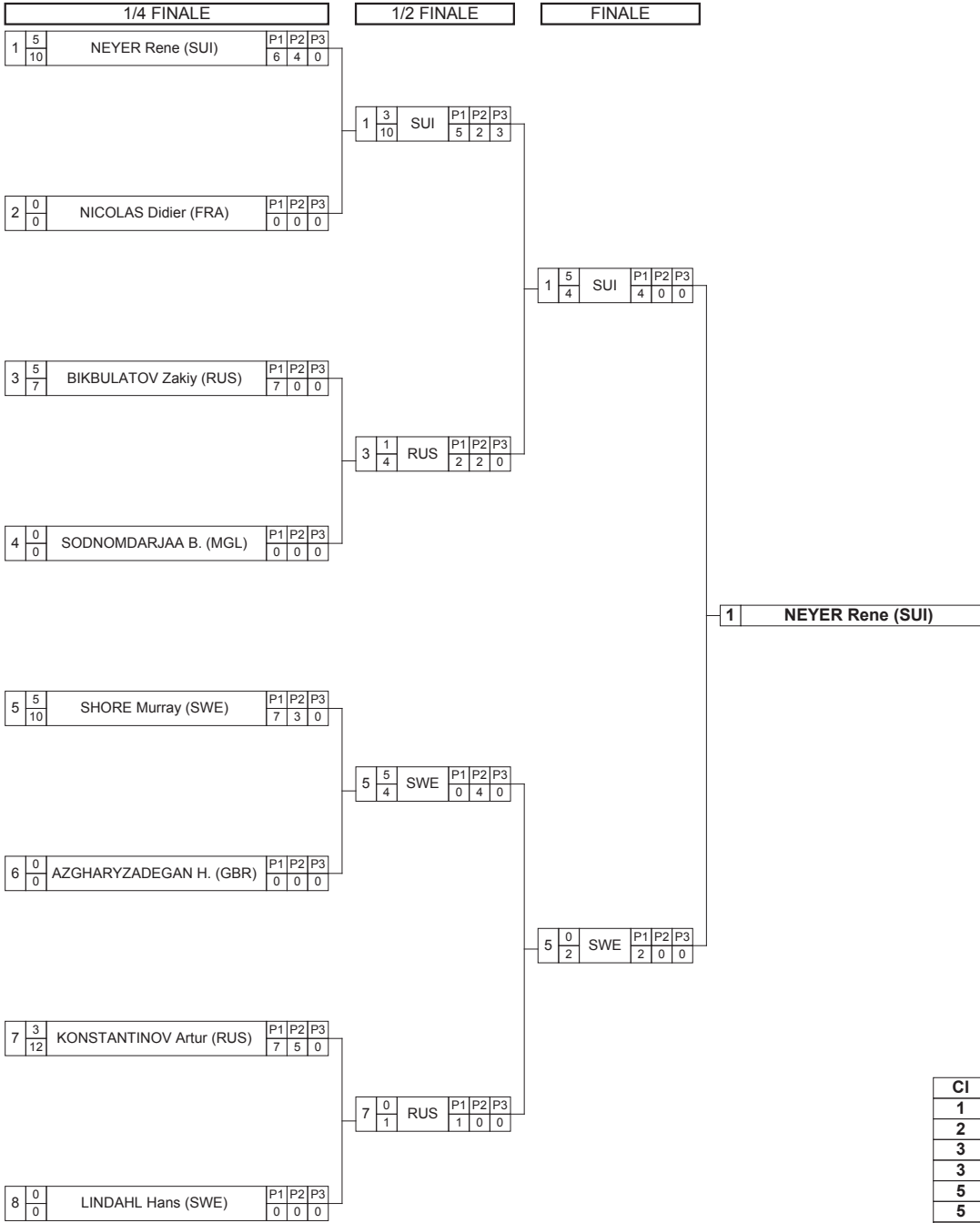
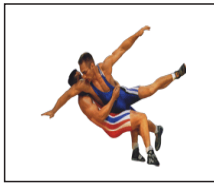

Classement

Cl	Pays	Nom
1	SUI	NEYER Rene
2	SWE	SHORE Murray
3	FRA	NICOLAS Didier
3	GBR	AZGHARYZADEGAN H.
5	RUS	BIKBULATOV Zakiy
5	RUS	KONSTANTINOV Artur
7	MGL	SODNOMDARJAA B.
8	SWE	LINDAHL Hans

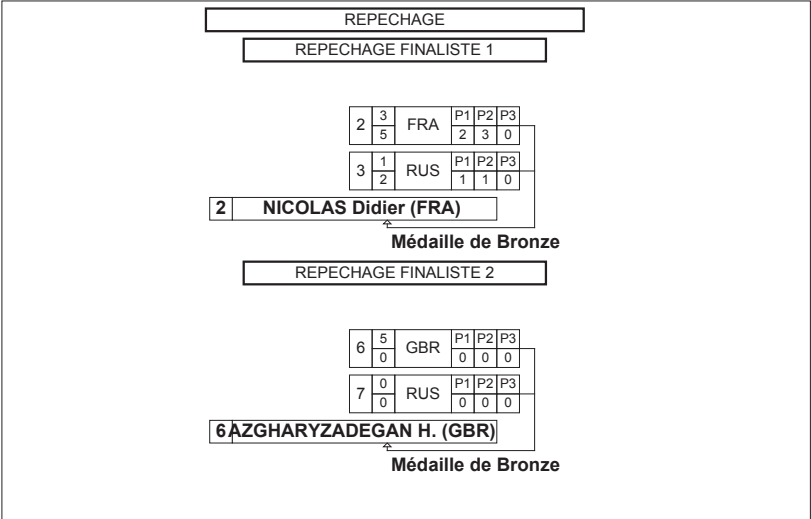



Feuille de compétition / Competition Sheet

Veteran WCH DIV D

STYLE : FS 76 kg

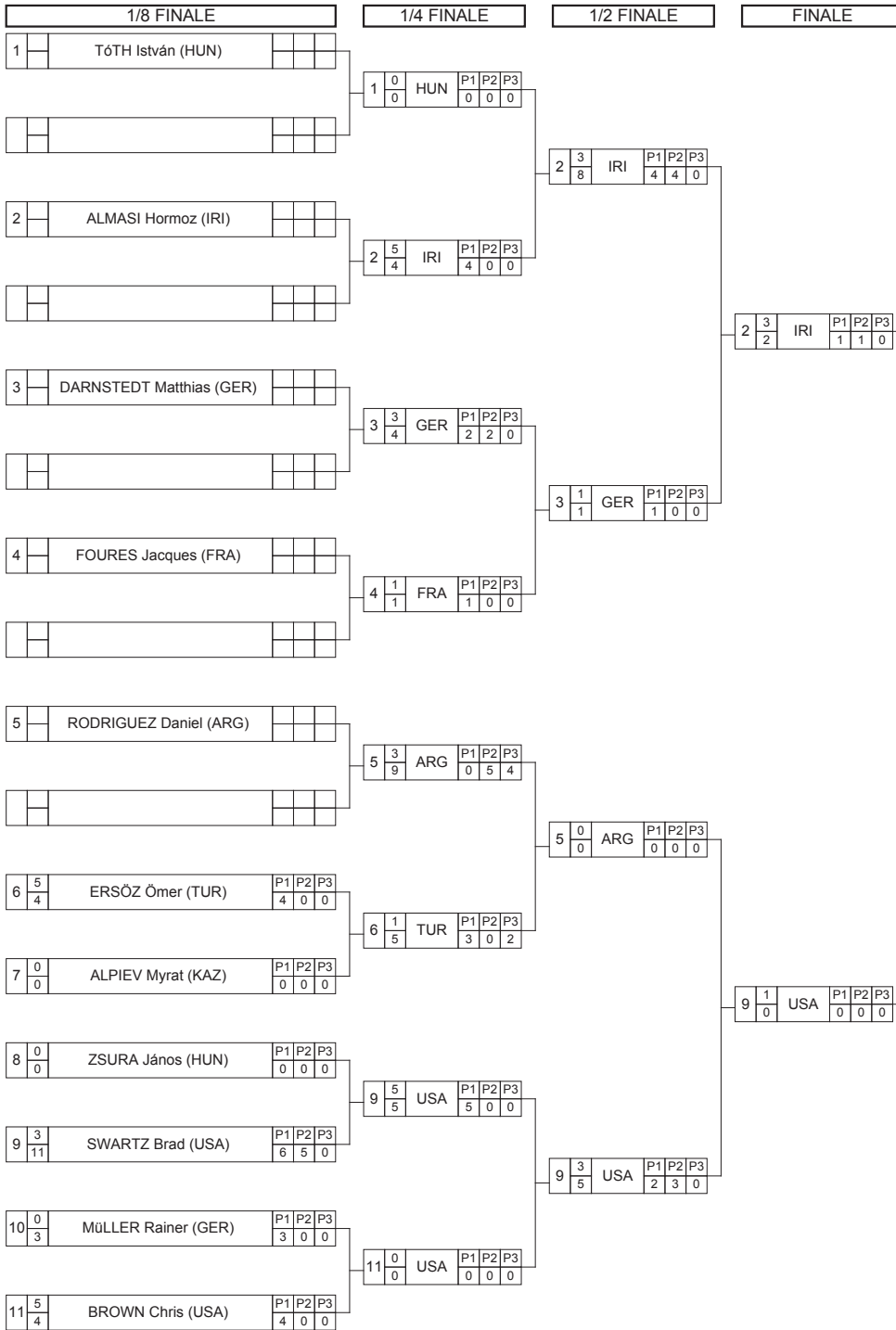

Classement

Cl	Pays	Nom
1	IRI	ALMASI Hormoz
2	USA	SWARTZ Brad
3	GER	DARNSTEDT Matthias
3	ARG	RODRIGUEZ Daniel
5	HUN	TóTH István
5	HUN	ZSURA János
7	TUR	ERSÓZ Ömer
8	USA	BROWN Chris
9	FRA	FOURES Jacques
10	GER	MÜLLER Rainer
11	KAZ	ALPIEV Myrat

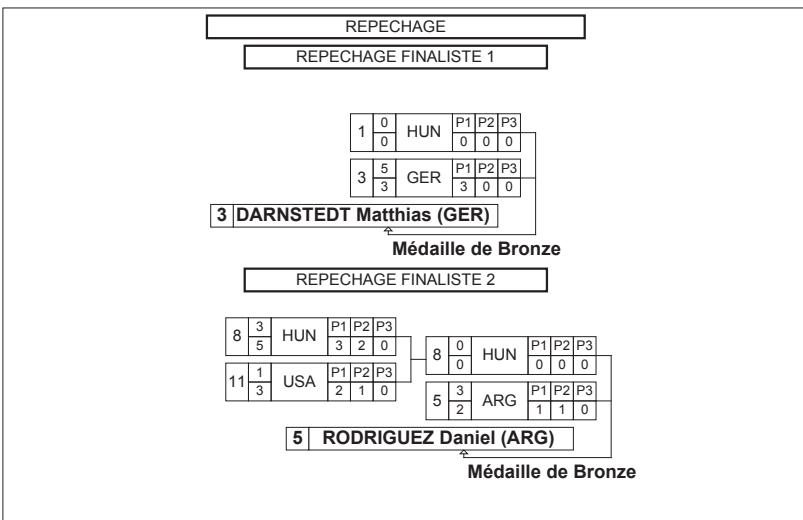



Feuille de compétition / Competition Sheet

Veteran WCH DIV D

STYLE : FS 85 kg



Classement

Cl	Pays	Nom
1	RSA	PUTTER Willem
2	RUS	PONOMARENKO Oleg
3	RUS	KESAEV Aslan
3	BEL	ASGABOV Issa
5	TUR	ÖZDEMIR Hasan
5	HUN	JÁSZKAI István
7	RUS	UTEPPERGENOV N.
8	USA	STENSGARD Gregg
9	GER	GöSCHEL Herald

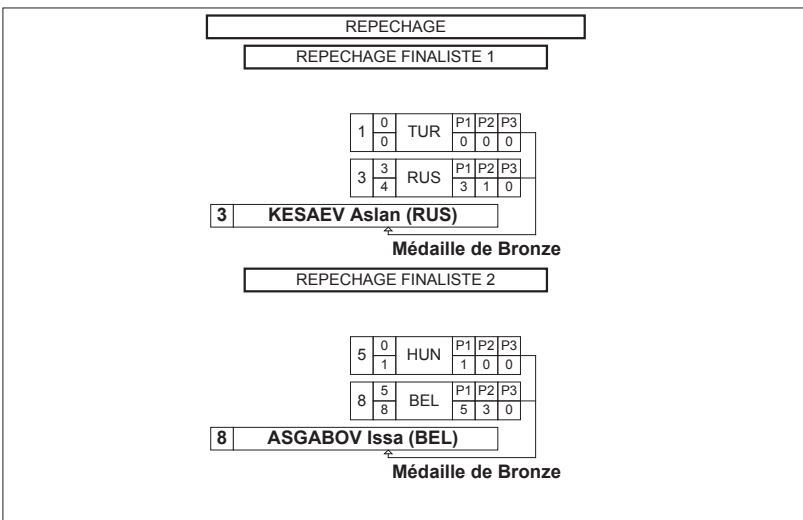



Feuille de compétition / Competition Sheet

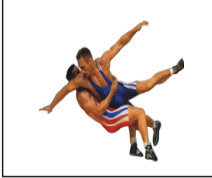

Veteran WCH DIV D

STYLE : FS 97 kg

1/4 FINALE	1/2 FINALE	FINALE
------------	------------	--------

1		PIENAAR Francois (RSA)	P1	P2	P3
			0	1	0

1		RSA	P1	P2	P3
			0	1	0

2		KAZAKOV Nikolay (RUS)	P1	P2	P3
			0	0	0

2		RUS	P1	P2	P3
			6	5	0

2		RUS	P1	P2	P3
			3	9	7

2		KAZAKOV Nikolay (RUS)	P1	P2	P3
			0	0	0

3		BOZDAG Ibrahim (TUR)	P1	P2	P3
			3	2	0

3		TUR	P1	P2	P3
			4	3	0

4		VERTOKHVOSTOV A. (RUS)	P1	P2	P3
			0	0	0

3		TUR	P1	P2	P3
			3	3	0

5		IASULOV Idris (RUS)	P1	P2	P3
			1	0	1

5		RUS	P1	P2	P3
			0	3	0

6		ZABAKOV Abdulla (KAZ)	P1	P2	P3
			0	1	0

Classement

Cl	Pays	Nom
1	RUS	KAZAKOV Nikolay
2	TUR	BOZDAG Ibrahim
3	RSA	PIENAAR Francois
3	RUS	VERTOKHVOSTOV A.
5	RUS	IASULOV Idris
6	KAZ	ZABAKOV Abdulla

REPECHAGE

REPECHAGE FINALISTE 1

1		PIENAAR Francois (RSA)	P1	P2	P3
			0	0	0

REPECHAGE FINALISTE 2

4		RUS	P1	P2	P3
			3	6	0

5		RUS	P1	P2	P3
			0	0	0

4 VERTOKHVOSTOV A. (RUS)

Médaille de Bronze



Feuille de compétition / Competition Sheet

Veteran WCH DIV D

STYLE : FS 130 kg

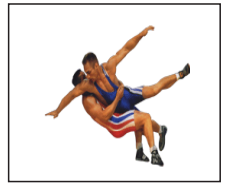

TOUR : 1

1		FÖLDESI István (HUN)	P1	P2	P3	()
	0		0	0	0	
2		GHALEHKOHNEH Reza (IRI)	P1	P2	P3	
	0		0	0	0	

Classement

Cl	Pays	Nom	Points
1	HUN	FÖLDESI István	4
2	IRI	GHALEHKOHNEH Reza	0



Feuille de compétition / Competition Sheet

Veteran WCH DIV E

STYLE : FS 58 kg

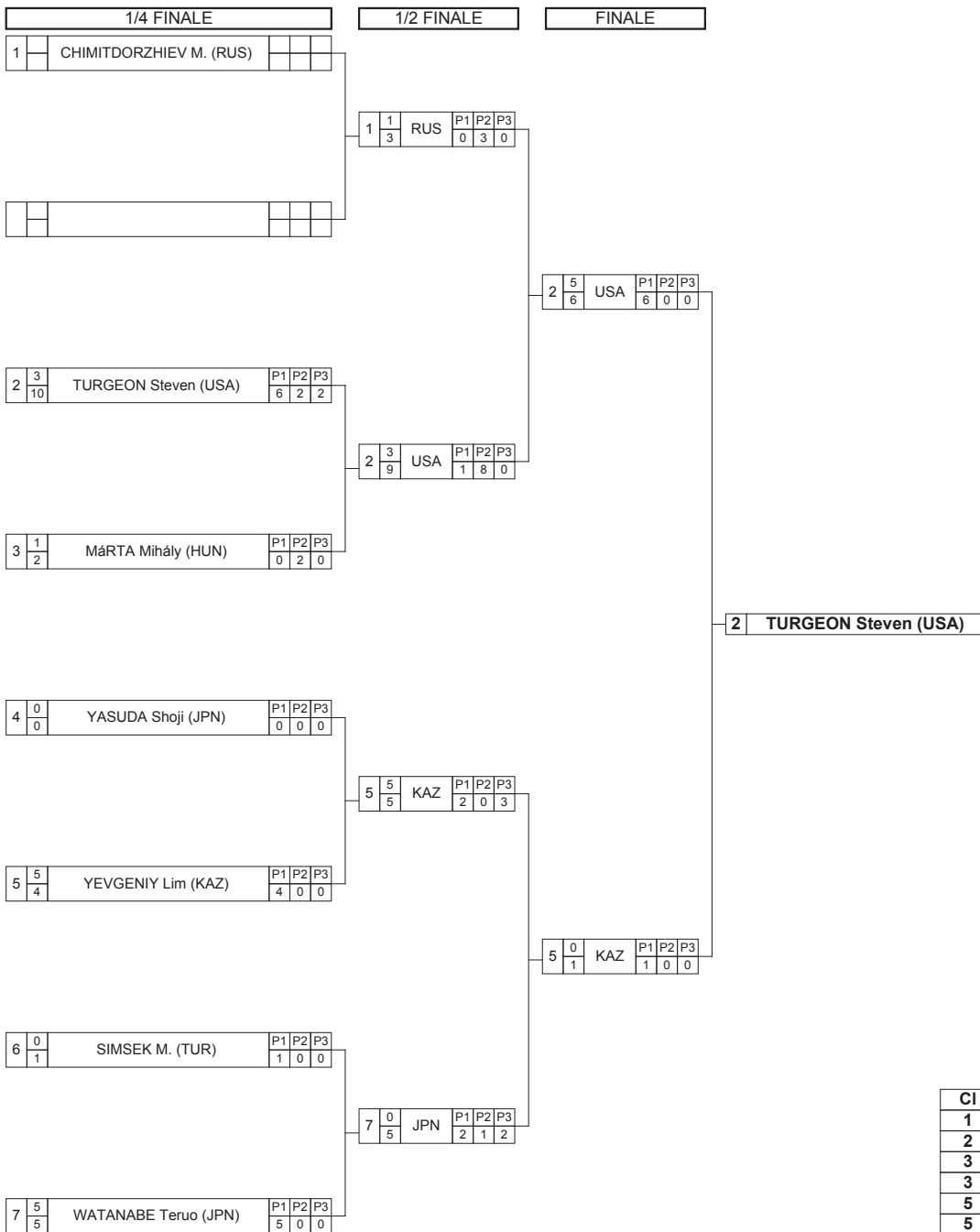
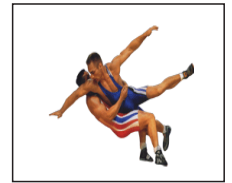

Classement

Cl	Pays	Nom
1	USA	TURGEON Steven
2	KAZ	YEVGENIY Lim
3	RUS	CHIMITDORZHIEV M.
3	JPN	WATANABE Teruo
5	HUN	MáRTA Mihály
5	JPN	YASUDA Shoji
7	TUR	SIMSEK Mehmet Latif

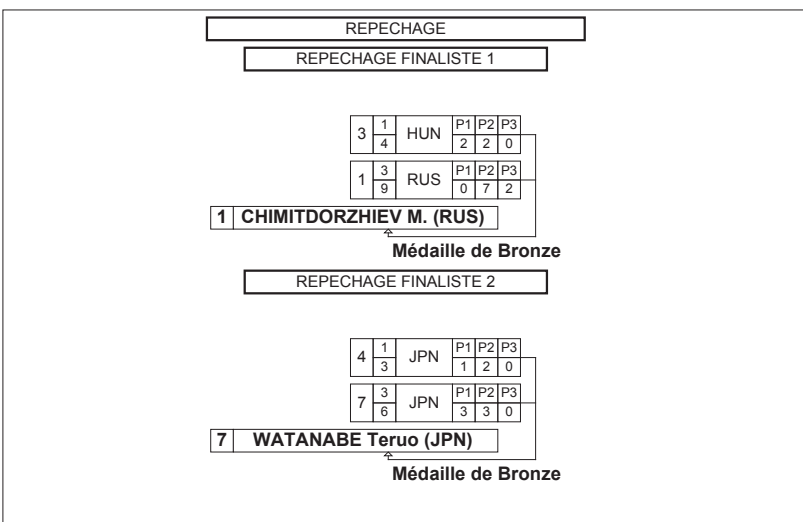



Feuille de compétition / Competition Sheet

Veteran WCH DIV E

STYLE : FS 63 kg



TOUR : 1

1	$\frac{1}{7}$	HECKMANN Peter (GER)	P1	P2	P3	2	BARKMAN Steven (USA)
			0	6	1		
2	$\frac{3}{11}$	BARKMAN Steven (USA)	P1	P2	P3		
			5	2	4		
3	$\frac{3}{5}$	MALTSEV Sergey (RUS)	P1	P2	P3	3	MALTSEV Sergey (RUS)
			2	3	0		
4	$\frac{0}{0}$	KAZHENKIN Andrej (RUS)	P1	P2	P3		
			0	0	0		

TOUR : 2

1	$\frac{0}{0}$	HECKMANN Peter (GER)	P1	P2	P3	3	MALTSEV Sergey (RUS)
			0	0	0		
3	$\frac{4}{8}$	MALTSEV Sergey (RUS)	P1	P2	P3		
			4	4	0		
2	$\frac{0}{0}$	BARKMAN Steven (USA)	P1	P2	P3	4	KAZHENKIN Andrej (RUS)
			0	0	0		
4	$\frac{4}{0}$	KAZHENKIN Andrej (RUS)	P1	P2	P3		
			0	0	0		

TOUR : 3

1	$\frac{3}{6}$	HECKMANN Peter (GER)	P1	P2	P3	1	HECKMANN Peter (GER)
			1	4	1		
4	$\frac{1}{6}$	KAZHENKIN Andrej (RUS)	P1	P2	P3		
			0	6	0		
2	$\frac{0}{0}$	BARKMAN Steven (USA)	P1	P2	P3	3	MALTSEV Sergey (RUS)
			0	0	0		
3	$\frac{4}{0}$	MALTSEV Sergey (RUS)	P1	P2	P3		
			0	0	0		

Classement

Cl	Pays	Nom	Points
1	RUS	MALTSEV Sergey	11
2	RUS	KAZHENKIN Andrej	5
3	GER	HECKMANN Peter	4
4	USA	BARKMAN Steven	3



Feuille de compétition / Competition Sheet

Veteran WCH DIV E

STYLE : FS 69 kg



TOUR : 1

1	0 0	JOHNSON Craig (USA)	P1 0	P2 0	P3 0	2	POCHER Ehrhard (GER)
2	4 3	POCHER Ehrhard (GER)	P1 3	P2 0	P3 0		
3	3 3	MURTAZEV L. (RUS)	P1 2	P2 1	P3 0	3	MURTAZEV L. (RUS)
4	0 0	EFREMOV Efrem (RUS)	P1 0	P2 0	P3 0		

TOUR : 2

1	0 0	JOHNSON Craig (USA)	P1 0	P2 0	P3 0	3	MURTAZEV L. (RUS)
3	3 8	MURTAZEV L. (RUS)	P1 3	P2 5	P3 0		
2	3 3	POCHER Ehrhard (GER)	P1 1	P2 2	P3 0	2	POCHER Ehrhard (GER)
4	0 0	EFREMOV Efrem (RUS)	P1 0	P2 0	P3 0		

TOUR : 3

1	1 2	JOHNSON Craig (USA)	P1 0	P2 1	P3 1	4	EFREMOV Efrem (RUS)
4	3 4	EFREMOV Efrem (RUS)	P1 1	P2 0	P3 3		
2	4 3	POCHER Ehrhard (GER)	P1 3	P2 0	P3 0	2	POCHER Ehrhard (GER)
3	0 0	MURTAZEV L. (RUS)	P1 0	P2 0	P3 0		

Classement

Cl	Pays	Nom	Points
1	GER	POCHER Ehrhard	11
2	RUS	MURTAZEV L.	6
3	RUS	EFREMOV Efrem	3
4	USA	JOHNSON Craig	1



Feuille de compétition / Competition Sheet

Veteran WCH DIV E

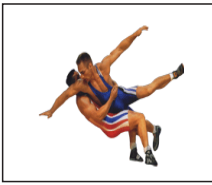

STYLE : FS 76 kg

1/4 FINALE

1/2 FINALE

FINALE

1		MARTA Petru (MDA)				
---	--	-------------------	--	--	--	--

1	5	MDA	P1	P2	P3
	4		1	3	0

--	--	--	--	--	--	--

2	0	GYÖRGYI István (HUN)	P1	P2	P3
	0		0	0	0

3	0	USA	P1	P2	P3
	1		1	0	0

3	3	ZIEGELBAUM Zelik (USA)	P1	P2	P3
	7		4	3	0

1	0	MDA	P1	P2	P3
	1		1	0	0

4	0	HENCZ Gyula (HUN)	P1	P2	P3
	1		1	0	0

5	1	GER	P1	P2	P3
	1		1	0	0

5	5	RADESTOCK Bernd (GER)	P1	P2	P3
	8		4	4	0

6	5	IRI	P1	P2	P3
	4		4	0	0

6	3	HOSSEINIKERMANSHAHI M. (IRI)	P1	P2	P3
	7		2	5	0

6	3	IRI	P1	P2	P3
	4		2	2	0

7	1	TARTLAN Tiit (EST)	P1	P2	P3
	1		0	1	0

HOSSEINIKERMANSHAHI M. (IRI)

Classement

Cl	Pays	Nom
1	IRI	HOSSEINIKERMANSHAHI M.
2	MDA	MARTA Petru
3	USA	ZIEGELBAUM Zelik
3	GER	RADESTOCK Bernd
5	EST	TARTLAN Tiit
6	HUN	HENCZ Gyula
7	HUN	GYÖRGYI István

REPECHAGE

REPECHAGE FINALISTE 1

3 ZIEGELBAUM Zelik (USA)

REPECHAGE FINALISTE 2

7	1	EST	P1	P2	P3
	2		0	2	0
5	3	GER	P1	P2	P3
	9		3	6	0

5 RADESTOCK Bernd (GER)

Médaille de Bronze



Feuille de compétition / Competition Sheet

Veteran WCH DIV E

STYLE : FS 85 kg

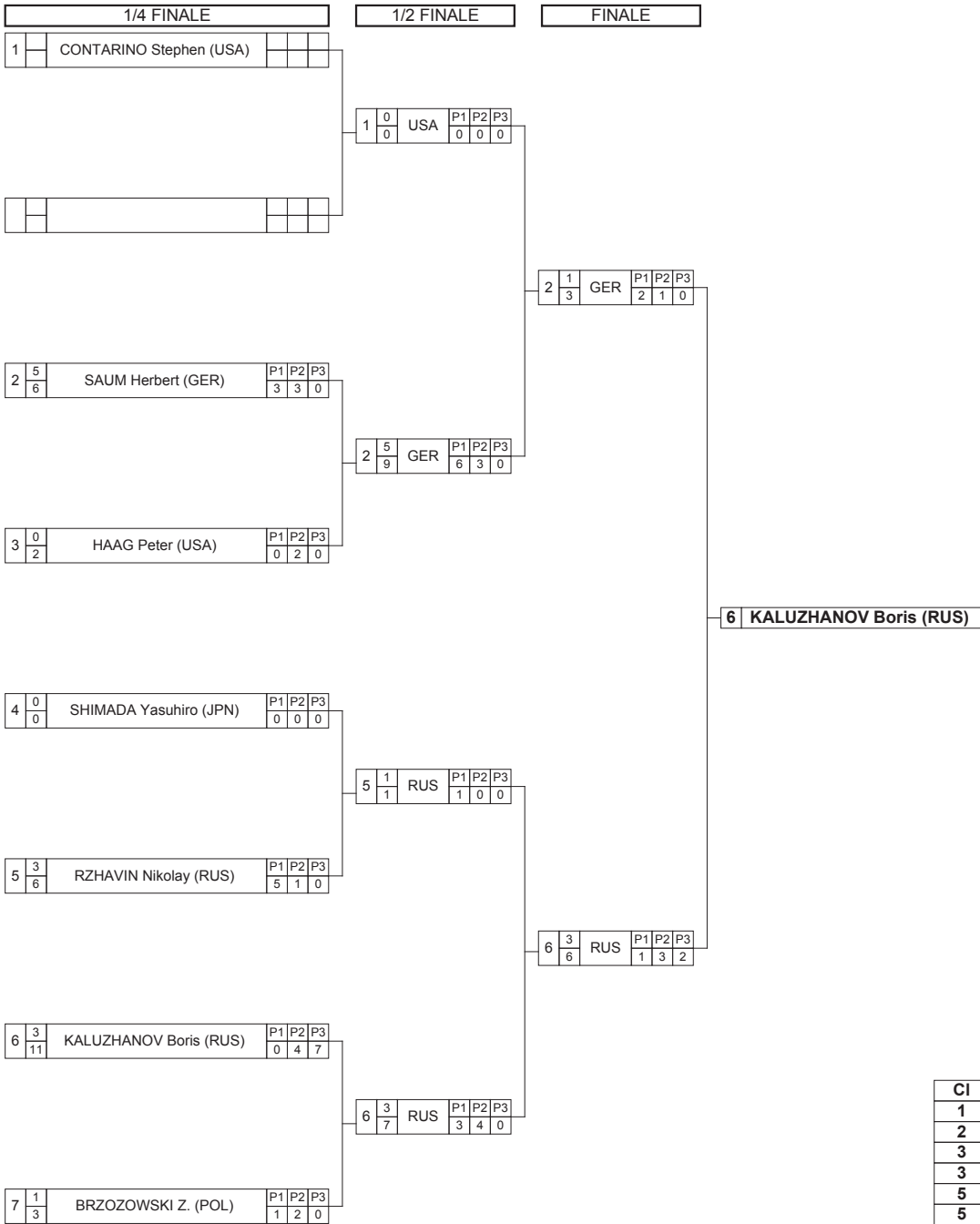
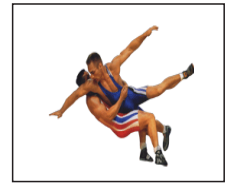

Classement

Cl	Pays	Nom
1	RUS	KALUZHANOV Boris
2	GER	SAUM Herbert
3	USA	CONTARINO Stephen
3	POL	BRZOWSKI Zdzislaw
5	USA	HAAG Peter
5	RUS	RZHAVIN Nikolay
7	JPN	SHIMADA Yasuhiro

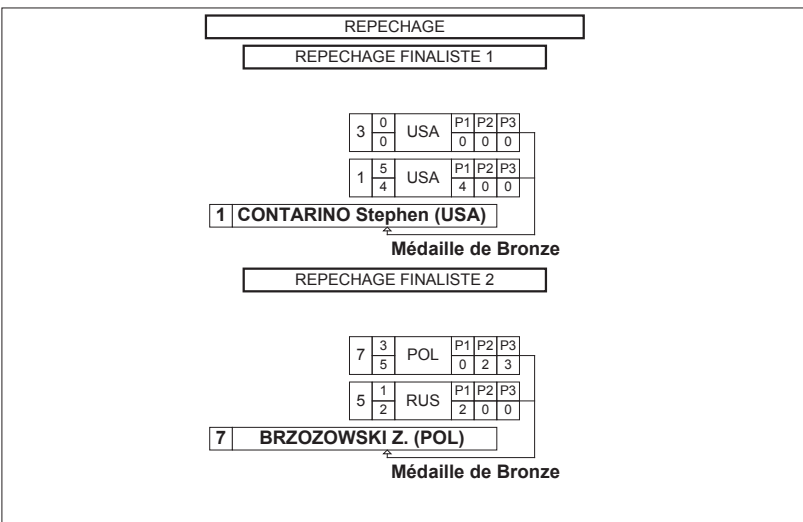



Feuille de compétition / Competition Sheet

Veteran WCH DIV E

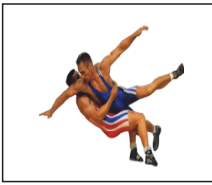

STYLE : FS 97 kg

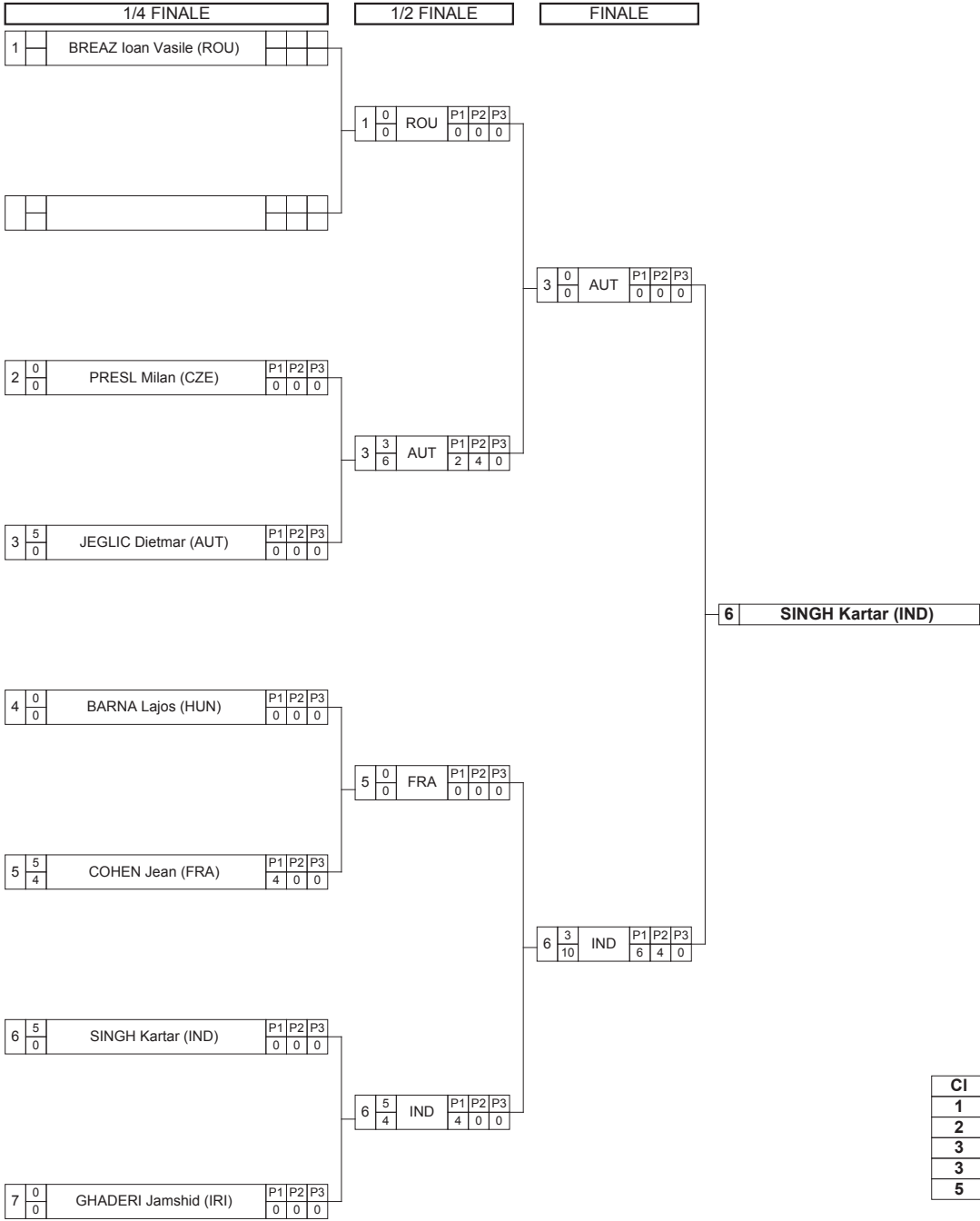

Classement

Cl	Pays	Nom
1	IND	SINGH Kartar
2	AUT	JEGLIC Dietmar
3	ROU	BREAZ Ioan Vasile
3	FRA	COHEN Jean
5	CZE	PRESL Milan

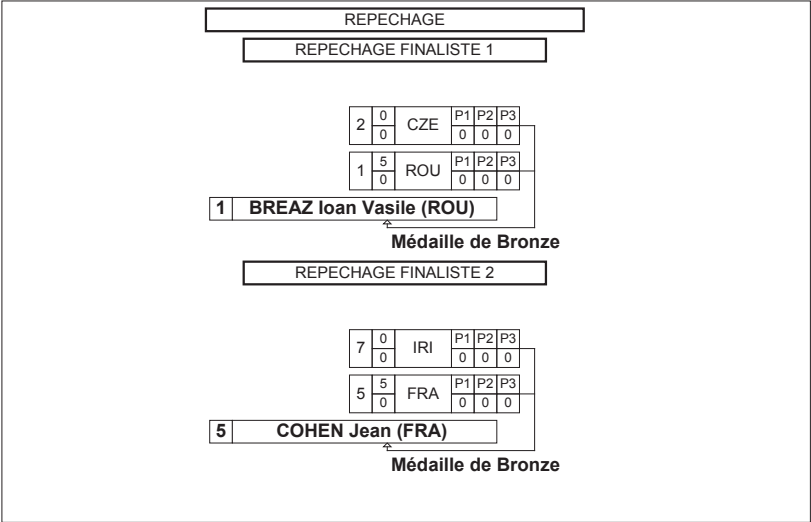



Feuille de compétition / Competition Sheet

Veteran WCH DIV E



STYLE : FS 130 kg

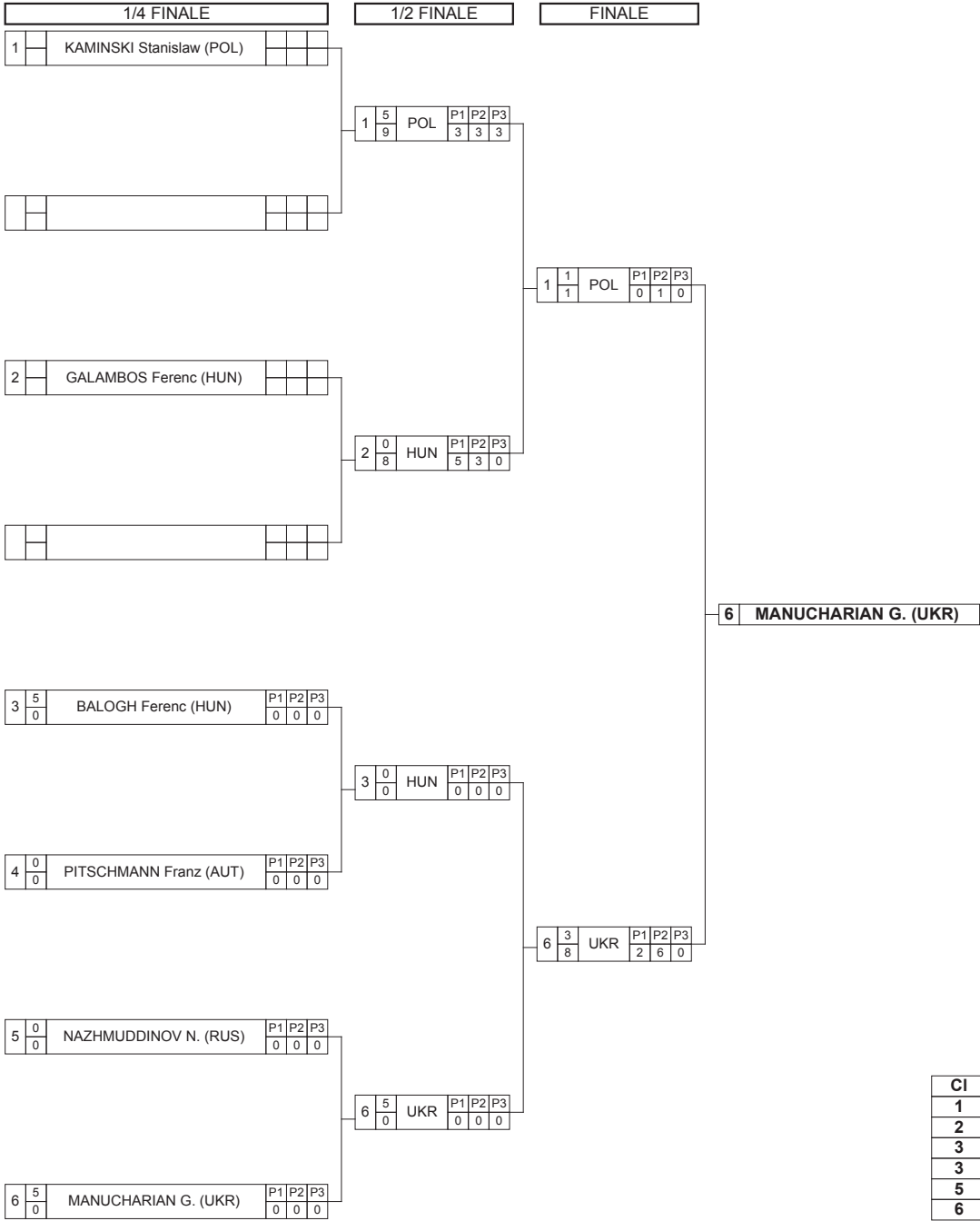

Classement

Cl	Pays	Nom
1	UKR	MANUCHARIAN Georgii
2	POL	KAMINSKI Stanislaw
3	HUN	GALAMBOS Ferenc
3	HUN	BALOGH Ferenc
5	RUS	NAZHMUDDINOV N.
6	AUT	PITSCHMANN Franz

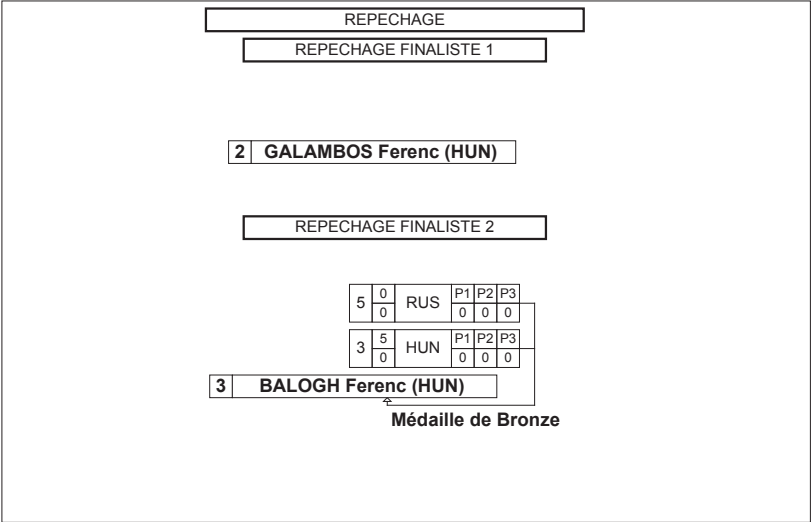



Feuille de compétition / Competition Sheet

Veteran WCH DIV F

STYLE : FS 58 kg



TOUR : 1

1	$\frac{0}{7}$	SOLDEV Fedot (RUS)	P1	P2	P3	2	KOCHKIN Ihhokentii (RUS)
			7	0	0		
2	$\frac{4}{5}$	KOCHKIN Ihhokentii (RUS)	P1	P2	P3		
			0	1	4		

TOUR : 2

3	$\frac{3}{10}$	CHIRKOV Victor (RUS)	P1	P2	P3	3	CHIRKOV Victor (RUS)
			6	4	0		
1	$\frac{0}{0}$	SOLDEV Fedot (RUS)	P1	P2	P3		
			0	0	0		

TOUR : 3

2	$\frac{1}{1}$	KOCHKIN Ihhokentii (RUS)	P1	P2	P3	3	CHIRKOV Victor (RUS)
			1	0	0		
3	$\frac{3}{3}$	CHIRKOV Victor (RUS)	P1	P2	P3		
			0	2	1		

Classement

Cl	Pays	Nom	Points
1	RUS	CHIRKOV Victor	6
2	RUS	KOCHKIN Ihhokentii	5
3	RUS	SOLDEV Fedot	0



Feuille de compétition / Competition Sheet

Veteran WCH DIV F

STYLE : FS 63 kg



TOUR : 1

1	$\frac{3}{12}$	AKOPNIN Mikhail (RUS)	P1	P2	P3	1	AKOPNIN Mikhail (RUS)
			6	2	4		
2	$\frac{1}{5}$	ALIYEV Ali (AZE)	P1	P2	P3		
			0	5	0		
3	$\frac{0}{0}$	SHOPAROV Shupago (RUS)	P1	P2	P3	4	AHMADI Shizard (USA)
			0	0	0		
4	$\frac{3}{4}$	AHMADI Shizard (USA)	P1	P2	P3		
			3	1	0		

TOUR : 2

5	$\frac{3}{9}$	HORNBUCKLE Jack (USA)	P1	P2	P3	5	HORNBUCKLE Jack (USA)
			4	1	4		
1	$\frac{1}{5}$	AKOPNIN Mikhail (RUS)	P1	P2	P3		
			0	5	0		
2	$\frac{3}{5}$	ALIYEV Ali (AZE)	P1	P2	P3	2	ALIYEV Ali (AZE)
			4	1	0		
3	$\frac{1}{3}$	SHOPAROV Shupago (RUS)	P1	P2	P3		
			3	0	0		

TOUR : 3

4	$\frac{3}{9}$	AHMADI Shizard (USA)	P1	P2	P3	4	AHMADI Shizard (USA)
			3	6	0		
1	$\frac{0}{0}$	AKOPNIN Mikhail (RUS)	P1	P2	P3		
			0	0	0		
5	$\frac{3}{3}$	HORNBUCKLE Jack (USA)	P1	P2	P3	5	HORNBUCKLE Jack (USA)
			1	2	0		
2	$\frac{0}{0}$	ALIYEV Ali (AZE)	P1	P2	P3		
			0	0	0		

TOUR : 4

3	$\frac{0}{3}$	SHOPAROV Shupago (RUS)	P1	P2	P3	1	AKOPNIN Mikhail (RUS)
			3	0	0		
1	$\frac{4}{5}$	AKOPNIN Mikhail (RUS)	P1	P2	P3		
			1	4	0		
4	$\frac{3}{10}$	AHMADI Shizard (USA)	P1	P2	P3	4	AHMADI Shizard (USA)
			6	4	0		
5	$\frac{0}{0}$	HORNBUCKLE Jack (USA)	P1	P2	P3		
			0	0	0		

TOUR : 5

2	$\frac{0}{0}$	ALIYEV Ali (AZE)	P1	P2	P3	4	AHMADI Shizard (USA)
			0	0	0		
4	$\frac{4}{0}$	AHMADI Shizard (USA)	P1	P2	P3		
			0	0	0		
3	$\frac{0}{0}$	SHOPAROV Shupago (RUS)	P1	P2	P3	5	HORNBUCKLE Jack (USA)
			0	0	0		
5	$\frac{3}{5}$	HORNBUCKLE Jack (USA)	P1	P2	P3		
			3	2	0		

Classement

Cl	Pays	Nom	Points
1	USA	AHMADI Shizard	13
2	USA	HORNBUCKLE Jack	9
3	RUS	AKOPNIN Mikhail	8
4	AZE	ALIYEV Ali	4
5	RUS	SHOPAROV Shupago	1



Feuille de compétition / Competition Sheet

Veteran WCH DIV F

STYLE : FS 69 kg

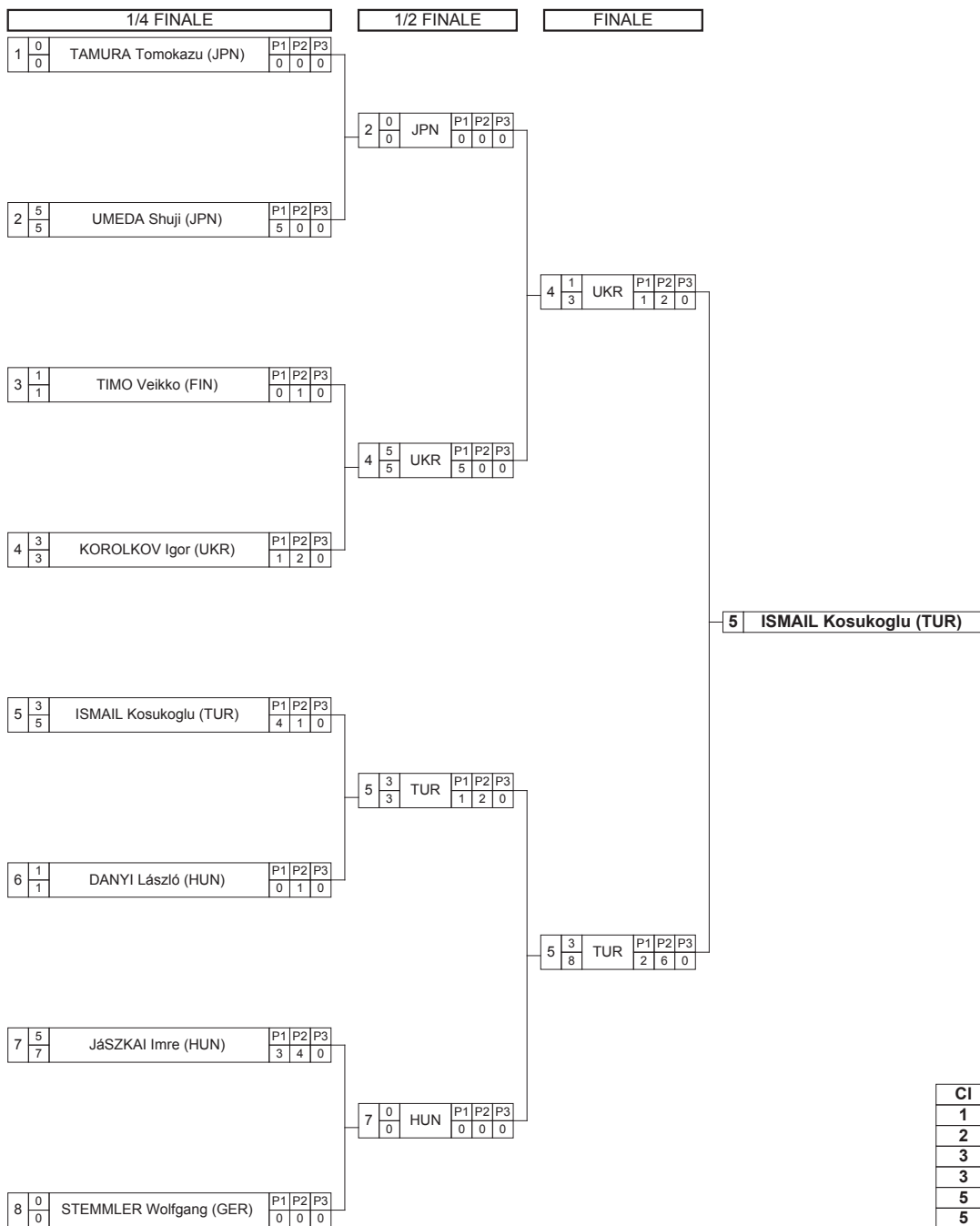

Classement

Cl	Pays	Nom
1	TUR	ISMAIL Kosukoglu
2	UKR	KOROLKOV Igor
3	FIN	TIMO Veikko
3	HUN	JÁSZKAI Imre
5	JPN	UMEDA Shuji
5	HUN	DANYI László
7	JPN	TAMURA Tomokazu
8	GER	STEMMLER Wolfgang

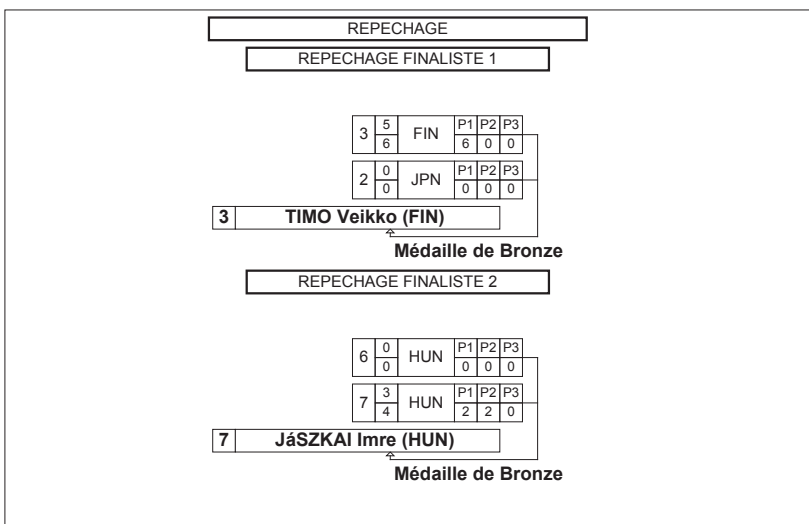



Feuille de compétition / Competition Sheet

Veteran WCH DIV F

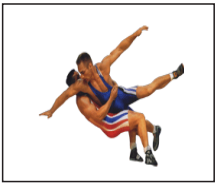

STYLE : FS 76 kg

1/4 FINALE

1/2 FINALE

FINALE

1 ANCIL Pat (USA)

1 0 USA P1 P2 P3
2 2 0 0

Empty box for 1/4 final result

2 ARCHER Greg (USA)

2 5 USA P1 P2 P3
8 5 3 0

Empty box for 1/4 final result

3 0 TAUTKUS Henrihs (LAT) P1 P2 P3
0 0 0 0

4 5 RUS P1 P2 P3
4 4 0 0

4 5 BADRUDINOV Magomed (RUS) P1 P2 P3
9 5 4 0

5 5 ABISHEV Kaldybay (KAZ) P1 P2 P3
6 6 0 0

5 0 KAZ P1 P2 P3
2 2 0 0

6 0 SZÁVA József (HUN) P1 P2 P3
0 0 0 0

2 1 USA P1 P2 P3
5 5 0 0

4 BADRUDINOV Magomed (RUS)

4 3 RUS P1 P2 P3
9 3 2 4

Classement

Cl	Pays	Nom
1	RUS	BADRUDINOV Magomed
2	USA	ARCHER Greg
3	USA	ANCIL Pat
3	KAZ	ABISHEV Kaldybay
5	LAT	TAUTKUS Henrihs
6	HUN	SZÁVA József

REPECHAGE

REPECHAGE FINALISTE 1

1 ANCIL Pat (USA)

REPECHAGE FINALISTE 2

3 0 LAT P1 P2 P3
0 0 0 0

5 5 KAZ P1 P2 P3
3 3 0 0

5 ABISHEV Kaldybay (KAZ)

Médaille de Bronze



Feuille de compétition / Competition Sheet

Veteran WCH DIV F

STYLE : FS 85 kg



TOUR : 1

1	1 2	KHLEBNIKOV Dmitry (RUS)	P1 1	P2 1	P3 0	2	JOZLOWSKI S. (GER)
2	3 7	JOZLOWSKI S. (GER)	P1 0	P2 4	P3 3		
3	0 0	SZéNÁSI János (HUN)	P1 0	P2 0	P3 0	4	PRICE Gary (USA)
4	4 9	PRICE Gary (USA)	P1 6	P2 3	P3 0		

TOUR : 2

5	0 0	YAROSHENKO Nikolay (RUS)	P1 0	P2 0	P3 0	1	KHLEBNIKOV Dmitry (RUS)
1	4 0	KHLEBNIKOV Dmitry (RUS)	P1 0	P2 0	P3 0		
2	4 7	JOZLOWSKI S. (GER)	P1 7	P2 0	P3 0	2	JOZLOWSKI S. (GER)
3	0 0	SZéNÁSI János (HUN)	P1 0	P2 0	P3 0		

TOUR : 3

4	0 3	PRICE Gary (USA)	P1 3	P2 0	P3 0	1	KHLEBNIKOV Dmitry (RUS)
1	4 4	KHLEBNIKOV Dmitry (RUS)	P1 4	P2 0	P3 0		
5	0 0	YAROSHENKO Nikolay (RUS)	P1 0	P2 0	P3 0	2	JOZLOWSKI S. (GER)
2	4 0	JOZLOWSKI S. (GER)	P1 0	P2 0	P3 0		

TOUR : 4

3	0 0	SZéNÁSI János (HUN)	P1 0	P2 0	P3 0	1	KHLEBNIKOV Dmitry (RUS)
1	4 4	KHLEBNIKOV Dmitry (RUS)	P1 4	P2 0	P3 0		
4	4 0	PRICE Gary (USA)	P1 0	P2 0	P3 0	4	PRICE Gary (USA)
5	0 0	YAROSHENKO Nikolay (RUS)	P1 0	P2 0	P3 0		

TOUR : 5

2	4 12	JOZLOWSKI S. (GER)	P1 6	P2 6	P3 0	2	JOZLOWSKI S. (GER)
4	0 0	PRICE Gary (USA)	P1 0	P2 0	P3 0		
3	4 0	SZéNÁSI János (HUN)	P1 0	P2 0	P3 0	3	SZéNÁSI János (HUN)
5	0 0	YAROSHENKO Nikolay (RUS)	P1 0	P2 0	P3 0		

Classement

Cl	Pays	Nom	Points
1	GER	JOZLOWSKI Siegfried	15
2	RUS	KHLEBNIKOV Dmitry	13
3	USA	PRICE Gary	8
4	HUN	SZéNÁSI János	4
5	RUS	YAROSHENKO Nikolay	0



Feuille de compétition / Competition Sheet

Veteran WCH DIV F

STYLE : FS 97 kg



TOUR : 1

1	1 4	SKOLNIK Josef (CZE)	P1 4	P2 0	P3 0	2	VEKLICH Anatoliy (KAZ)
2	4 13	VEKLICH Anatoliy (KAZ)	P1 1	P2 6	P3 6		
3	1 1	BAGCI Ismet (TUR)	P1 0	P2 1	P3 0	4	SAMMET Artur (GER)
4	3 5	SAMMET Artur (GER)	P1 4	P2 1	P3 0		

TOUR : 2

1	0 0	SKOLNIK Josef (CZE)	P1 0	P2 0	P3 0	3	BAGCI Ismet (TUR)
3	3 7	BAGCI Ismet (TUR)	P1 6	P2 1	P3 0		
2	0 2	VEKLICH Anatoliy (KAZ)	P1 0	P2 2	P3 0	4	SAMMET Artur (GER)
4	4 6	SAMMET Artur (GER)	P1 2	P2 4	P3 0		

TOUR : 3

1	0 0	SKOLNIK Josef (CZE)	P1 0	P2 0	P3 0	4	SAMMET Artur (GER)
4	4 11	SAMMET Artur (GER)	P1 7	P2 4	P3 0		
2	1 3	VEKLICH Anatoliy (KAZ)	P1 0	P2 3	P3 0	3	BAGCI Ismet (TUR)
3	3 4	BAGCI Ismet (TUR)	P1 1	P2 3	P3 0		

Classement

Cl	Pays	Nom	Points
1	GER	SAMMET Artur	11
2	TUR	BAGCI Ismet	7
3	KAZ	VEKLICH Anatoliy	5
4	CZE	SKOLNIK Josef	1



Feuille de compétition / Competition Sheet

Veteran WCH DIV F

STYLE : FS 130 kg



TOUR : 1

1	$\frac{0}{4}$	GUZIEV Mukhamed (RUS)	P1	P2	P3	2	ETZEBETH George (RSA)
			4	0	0		
2	$\frac{4}{10}$	ETZEBETH George (RSA)	P1	P2	P3		
			1	5	4		
3	$\frac{4}{9}$	SHEMAROV Nikolay (RUS)	P1	P2	P3	3	SHEMAROV Nikolay (RUS)
			6	3	0		
4	$\frac{0}{0}$	WAGNER Mihály (HUN)	P1	P2	P3		
			0	0	0		

TOUR : 2

5	$\frac{4}{5}$	GOGLICHIDZE Estate (GEO)	P1	P2	P3	5	GOGLICHIDZE Estate (GEO)
			5	0	0		
1	$\frac{0}{0}$	GUZIEV Mukhamed (RUS)	P1	P2	P3		
			0	0	0		
2	$\frac{3}{4}$	ETZEBETH George (RSA)	P1	P2	P3	2	ETZEBETH George (RSA)
			3	0	1		
3	$\frac{1}{1}$	SHEMAROV Nikolay (RUS)	P1	P2	P3		
			0	1	0		

TOUR : 3

4	$\frac{0}{0}$	WAGNER Mihály (HUN)	P1	P2	P3	1	GUZIEV Mukhamed (RUS)
			0	0	0		
1	$\frac{4}{4}$	GUZIEV Mukhamed (RUS)	P1	P2	P3		
			4	0	0		
5	$\frac{0}{1}$	GOGLICHIDZE Estate (GEO)	P1	P2	P3	2	ETZEBETH George (RSA)
			1	0	0		
2	$\frac{4}{1}$	ETZEBETH George (RSA)	P1	P2	P3		
			1	0	0		

TOUR : 4

3	$\frac{3}{7}$	SHEMAROV Nikolay (RUS)	P1	P2	P3	3	SHEMAROV Nikolay (RUS)
			3	4	0		
1	$\frac{0}{0}$	GUZIEV Mukhamed (RUS)	P1	P2	P3		
			0	0	0		
4	$\frac{0}{0}$	WAGNER Mihály (HUN)	P1	P2	P3	5	GOGLICHIDZE Estate (GEO)
			0	0	0		
5	$\frac{4}{3}$	GOGLICHIDZE Estate (GEO)	P1	P2	P3		
			3	0	0		

TOUR : 5

2	$\frac{4}{8}$	ETZEBETH George (RSA)	P1	P2	P3	2	ETZEBETH George (RSA)
			8	0	0		
4	$\frac{0}{0}$	WAGNER Mihály (HUN)	P1	P2	P3		
			0	0	0		
3	$\frac{4}{0}$	SHEMAROV Nikolay (RUS)	P1	P2	P3	3	SHEMAROV Nikolay (RUS)
			0	0	0		
5	$\frac{0}{0}$	GOGLICHIDZE Estate (GEO)	P1	P2	P3		
			0	0	0		

Classement

Cl	Pays	Nom	Points
1	RSA	ETZEBETH George	15
2	RUS	SHEMAROV Nikolay	12
3	GEO	GOGLICHIDZE Estate	8
4	RUS	GUZIEV Mukhamed	4
5	HUN	WAGNER Mihály	0



Feuille de compétition / Competition Sheet

Veteran WCH DIV G

STYLE : FS 58 kg



Classement

Cl	Pays	Nom	Points
1	KAZ	SHAKIROV Koblandy	0



Feuille de compétition / Competition Sheet

Veteran WCH DIV G

STYLE : FS 63 kg



TOUR : 1

1	0 0	MARGARYAN Vanik (RUS)	P1 0	P2 0	P3 0	2	BAUMANN Imre (HUN)
2	4 6	BAUMANN Imre (HUN)	P1 6	P2 0	P3 0		

TOUR : 2

3	4 0	JUHÁSZ Imre (HUN)	P1 0	P2 0	P3 0	3	JUHÁSZ Imre (HUN)
1	0 0	MARGARYAN Vanik (RUS)	P1 0	P2 0	P3 0		

TOUR : 3

2	3 4	BAUMANN Imre (HUN)	P1 1	P2 3	P3 0	2	BAUMANN Imre (HUN)
3	0 0	JUHÁSZ Imre (HUN)	P1 0	P2 0	P3 0		

Classement

Cl	Pays	Nom	Points
1	HUN	BAUMANN Imre	7
2	HUN	JUHÁSZ Imre	4
3	RUS	MARGARYAN Vanik	0



Feuille de compétition / Competition Sheet

Veteran WCH DIV G

STYLE : FS 69 kg



TOUR : 1

1	$\frac{4}{10}$	TONKIKH Viktor (RUS)	P1	P2	P3	1	TONKIKH Viktor (RUS)
			6	4	0		
2	$\frac{0}{0}$	PASANEN Jorma (FIN)	P1	P2	P3		
			0	0	0		
3	$\frac{4}{9}$	MINAEV Evgeny (RUS)	P1	P2	P3	3	MINAEV Evgeny (RUS)
			5	4	0		
4	$\frac{0}{3}$	CSATLÓ S István (HUN)	P1	P2	P3		
			3	0	0		

TOUR : 2

1	$\frac{3}{7}$	TONKIKH Viktor (RUS)	P1	P2	P3	1	TONKIKH Viktor (RUS)
			4	3	0		
3	$\frac{1}{1}$	MINAEV Evgeny (RUS)	P1	P2	P3		
			1	0	0		
2	$\frac{0}{0}$	PASANEN Jorma (FIN)	P1	P2	P3	4	CSATLÓ S István (HUN)
			0	0	0		
4	$\frac{4}{3}$	CSATLÓ S István (HUN)	P1	P2	P3		
			3	0	0		

TOUR : 3

1	$\frac{4}{6}$	TONKIKH Viktor (RUS)	P1	P2	P3	1	TONKIKH Viktor (RUS)
			6	0	0		
4	$\frac{0}{1}$	CSATLÓ S István (HUN)	P1	P2	P3		
			1	0	0		
2	$\frac{0}{0}$	PASANEN Jorma (FIN)	P1	P2	P3	3	MINAEV Evgeny (RUS)
			0	0	0		
3	$\frac{4}{8}$	MINAEV Evgeny (RUS)	P1	P2	P3		
			8	0	0		

Classement

Cl	Pays	Nom	Points
1	RUS	TONKIKH Viktor	11
2	RUS	MINAEV Evgeny	9
3	HUN	CSATLÓ S István	4
4	FIN	PASANEN Jorma	0



Feuille de compétition / Competition Sheet

Veteran WCH DIV G

STYLE : FS 76 kg



TOUR : 1

1	$\frac{4}{8}$	DALGATOV Magomed (RUS)	P1	P2	P3	1	DALGATOV Magomed (RUS)
			2	6	0		
2	$\frac{0}{3}$	MIHÁLYI Árpád (HUN)	P1	P2	P3		
			3	0	0		
3	$\frac{0}{3}$	HARRIS Terrell (USA)	P1	P2	P3	4	KÓNYA Lajos (HUN)
			3	0	0		
4	$\frac{4}{3}$	KÓNYA Lajos (HUN)	P1	P2	P3		
			3	0	0		

TOUR : 2

1	$\frac{3}{8}$	DALGATOV Magomed (RUS)	P1	P2	P3	1	DALGATOV Magomed (RUS)
			0	6	2		
3	$\frac{1}{6}$	HARRIS Terrell (USA)	P1	P2	P3		
			1	5	0		
2	$\frac{0}{2}$	MIHÁLYI Árpád (HUN)	P1	P2	P3	4	KÓNYA Lajos (HUN)
			2	0	0		
4	$\frac{4}{3}$	KÓNYA Lajos (HUN)	P1	P2	P3		
			3	0	0		

TOUR : 3

1	$\frac{0}{0}$	DALGATOV Magomed (RUS)	P1	P2	P3	4	KÓNYA Lajos (HUN)
			0	0	0		
4	$\frac{4}{3}$	KÓNYA Lajos (HUN)	P1	P2	P3		
			3	0	0		
2	$\frac{0}{0}$	MIHÁLYI Árpád (HUN)	P1	P2	P3	3	HARRIS Terrell (USA)
			0	0	0		
3	$\frac{4}{8}$	HARRIS Terrell (USA)	P1	P2	P3		
			8	0	0		

Classement

Cl	Pays	Nom	Points
1	HUN	KÓNYA Lajos	12
2	RUS	DALGATOV Magomed	7
3	USA	HARRIS Terrell	5
4	HUN	MIHÁLYI Árpád	0



Feuille de compétition / Competition Sheet

Veteran WCH DIV G

STYLE : FS 85 kg



Classement

Cl	Pays	Nom	Points
1	RUS	ALIDIBIROV A.	0



Feuille de compétition / Competition Sheet

Veteran WCH DIV G

STYLE : FS 97 kg



TOUR : 1

1	4 2	BELYAYEV Borys (UKR)	P1 2	P2 0	P3 0	1	BELYAYEV Borys (UKR)
2	0 1	ZATEZALO Savo (SRB)	P1 1	P2 0	P3 0		

TOUR : 2

3	0 0	HUSSEIN MOHAMED A. (FRA)	P1 0	P2 0	P3 0	1	BELYAYEV Borys (UKR)
1	4 11	BELYAYEV Borys (UKR)	P1 6	P2 5	P3 0		

TOUR : 3

2	4 4	ZATEZALO Savo (SRB)	P1 4	P2 0	P3 0	2	ZATEZALO Savo (SRB)
3	0 0	HUSSEIN MOHAMED A. (FRA)	P1 0	P2 0	P3 0		

Classement

Cl	Pays	Nom	Points
1	UKR	BELYAYEV Borys	8
2	SRB	ZATEZALO Savo	4
3	FRA	HUSSEIN MOHAMED A.	0



Feuille de compétition / Competition Sheet

Veteran WCH DIV G

STYLE : FS 130 kg

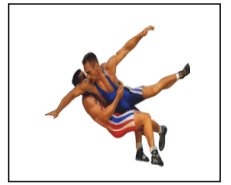

TOUR : 1

1	4	AMBRUS Ludovic (ROU)	P1	P2	P3	1	AMBRUS Ludovic (ROU)
	5		5	0	0		
2	0	BüCHLE Manfred (GER)	P1	P2	P3		
	0		0	0	0		

Classement

Cl	Pays	Nom	Points
1	ROU	AMBRUS Ludovic	4
2	GER	BüCHLE Manfred	0



Feuille de compétition / Competition Sheet

Veteran WCH DIV A

STYLE : GR 58 kg



TOUR : 1

1	$\frac{0}{5}$	PAPP László (HUN)	P1	P2	P3	2	BASAR Ersin (TUR)
			4	1	0		
2	$\frac{4}{4}$	BASAR Ersin (TUR)	P1	P2	P3		
			0	4	0		
3	$\frac{1}{7}$	GAMEZ JR Jose (USA)	P1	P2	P3	4	SULIMOV Maksim (UKR)
			3	4	0		
4	$\frac{3}{10}$	SULIMOV Maksim (UKR)	P1	P2	P3		
			6	4	0		

TOUR : 2

5	$\frac{3}{4}$	VIERLING Pierre (GER)	P1	P2	P3	5	VIERLING Pierre (GER)
			1	3	0		
1	$\frac{0}{0}$	PAPP László (HUN)	P1	P2	P3		
			0	0	0		
2	$\frac{3}{8}$	BASAR Ersin (TUR)	P1	P2	P3	2	BASAR Ersin (TUR)
			4	4	0		
3	$\frac{1}{1}$	GAMEZ JR Jose (USA)	P1	P2	P3		
			0	1	0		

TOUR : 3

4	$\frac{0}{0}$	SULIMOV Maksim (UKR)	P1	P2	P3	1	PAPP László (HUN)
			0	0	0		
1	$\frac{3}{4}$	PAPP László (HUN)	P1	P2	P3		
			1	3	0		
5	$\frac{3}{7}$	VIERLING Pierre (GER)	P1	P2	P3	5	VIERLING Pierre (GER)
			6	1	0		
2	$\frac{0}{0}$	BASAR Ersin (TUR)	P1	P2	P3		
			0	0	0		

TOUR : 4

3	$\frac{0}{0}$	GAMEZ JR Jose (USA)	P1	P2	P3	1	PAPP László (HUN)
			0	0	0		
1	$\frac{4}{8}$	PAPP László (HUN)	P1	P2	P3		
			8	0	0		
4	$\frac{0}{0}$	SULIMOV Maksim (UKR)	P1	P2	P3	5	VIERLING Pierre (GER)
			0	0	0		
5	$\frac{4}{0}$	VIERLING Pierre (GER)	P1	P2	P3		
			0	0	0		

TOUR : 5

2	$\frac{4}{0}$	BASAR Ersin (TUR)	P1	P2	P3	2	BASAR Ersin (TUR)
			0	0	0		
4	$\frac{0}{0}$	SULIMOV Maksim (UKR)	P1	P2	P3		
			0	0	0		
3	$\frac{0}{0}$	GAMEZ JR Jose (USA)	P1	P2	P3	5	VIERLING Pierre (GER)
			0	0	0		
5	$\frac{4}{13}$	VIERLING Pierre (GER)	P1	P2	P3		
			6	7	0		

Classement

Cl	Pays	Nom	Points
1	GER	VIERLING Pierre	14
2	TUR	BASAR Ersin	11
3	HUN	PAPP László	7
4	UKR	SULIMOV Maksim	3
5	USA	GAMEZ JR Jose	2



Feuille de compétition / Competition Sheet

Veteran WCH DIV A

STYLE : GR 69 kg



TOUR : 1

1	$\frac{3}{6}$	SIPOS Csaba (HUN)	P1	P2	P3	} 1	SIPOS Csaba (HUN)
			2	4	0		
2	$\frac{1}{1}$	RAMIREZLAZOS I. (USA)	P1	P2	P3		
			1	0	0		
3	$\frac{1}{2}$	LARSEN Trond Arild (NOR)	P1	P2	P3	} 4	SAMSONOV Olaksandr (UKR)
			1	1	0		
4	$\frac{3}{2}$	SAMSONOV Olaksandr (UKR)	P1	P2	P3		
			1	0	1		

TOUR : 2

1	$\frac{1}{1}$	SIPOS Csaba (HUN)	P1	P2	P3	} 3	LARSEN Trond Arild (NOR)
			1	0	0		
3	$\frac{3}{6}$	LARSEN Trond Arild (NOR)	P1	P2	P3		
			0	5	1		
2	$\frac{0}{0}$	RAMIREZLAZOS I. (USA)	P1	P2	P3	} 4	SAMSONOV Olaksandr (UKR)
			0	0	0		
4	$\frac{4}{11}$	SAMSONOV Olaksandr (UKR)	P1	P2	P3		
			7	4	0		

TOUR : 3

1	$\frac{1}{1}$	SIPOS Csaba (HUN)	P1	P2	P3	} 4	SAMSONOV Olaksandr (UKR)
			0	1	0		
4	$\frac{3}{8}$	SAMSONOV Olaksandr (UKR)	P1	P2	P3		
			5	3	0		
2	$\frac{0}{0}$	RAMIREZLAZOS I. (USA)	P1	P2	P3	} 3	LARSEN Trond Arild (NOR)
			0	0	0		
3	$\frac{3}{5}$	LARSEN Trond Arild (NOR)	P1	P2	P3		
			4	1	0		

Classement

Cl	Pays	Nom	Points
1	UKR	SAMSONOV Olaksandr	10
2	NOR	LARSEN Trond Arild	7
3	HUN	SIPOS Csaba	5
4	USA	RAMIREZLAZOS I.	1



Feuille de compétition / Competition Sheet

Veteran WCH DIV A

STYLE : GR 76 kg



Classement

Cl	Pays	Nom
1	SWE	SAMUELSSON Jimmy
2	HUN	MAGNUCZ Ferenc
3	KAZ	ZHOLAMANOV Malik
3	BIH	MARKOVIC Dragon
5	NOR	SVENDSEN A.
5	BLR	DUDKO Sjarhei
7	HUN	SÁROSI Tibor
8	FIN	LIPSONEN Tero
9	SWE	HEDBERG Johan
10	TUR	KARAKAS Cebrail
11	FIN	ALA-LUHTALA Jani
12	HUN	TAKÁCS László
13	UKR	RATUSHNYAK Sergiy

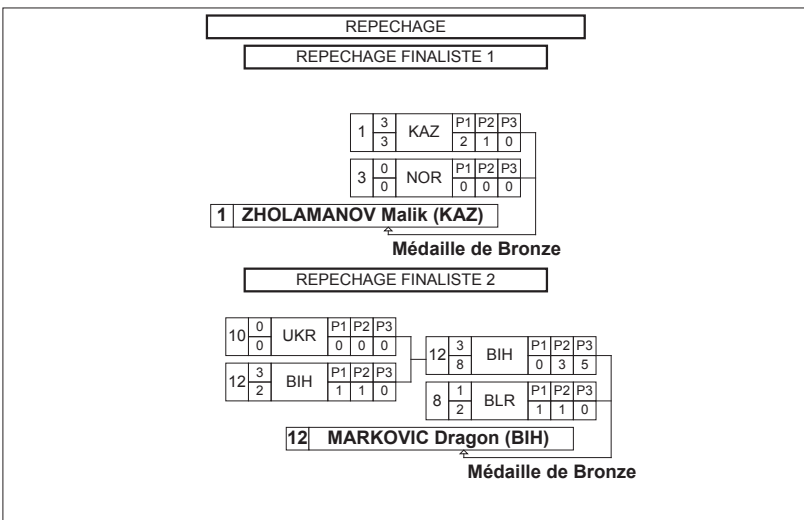



Feuille de compétition / Competition Sheet

Veteran WCH DIV A

STYLE : GR 85 kg

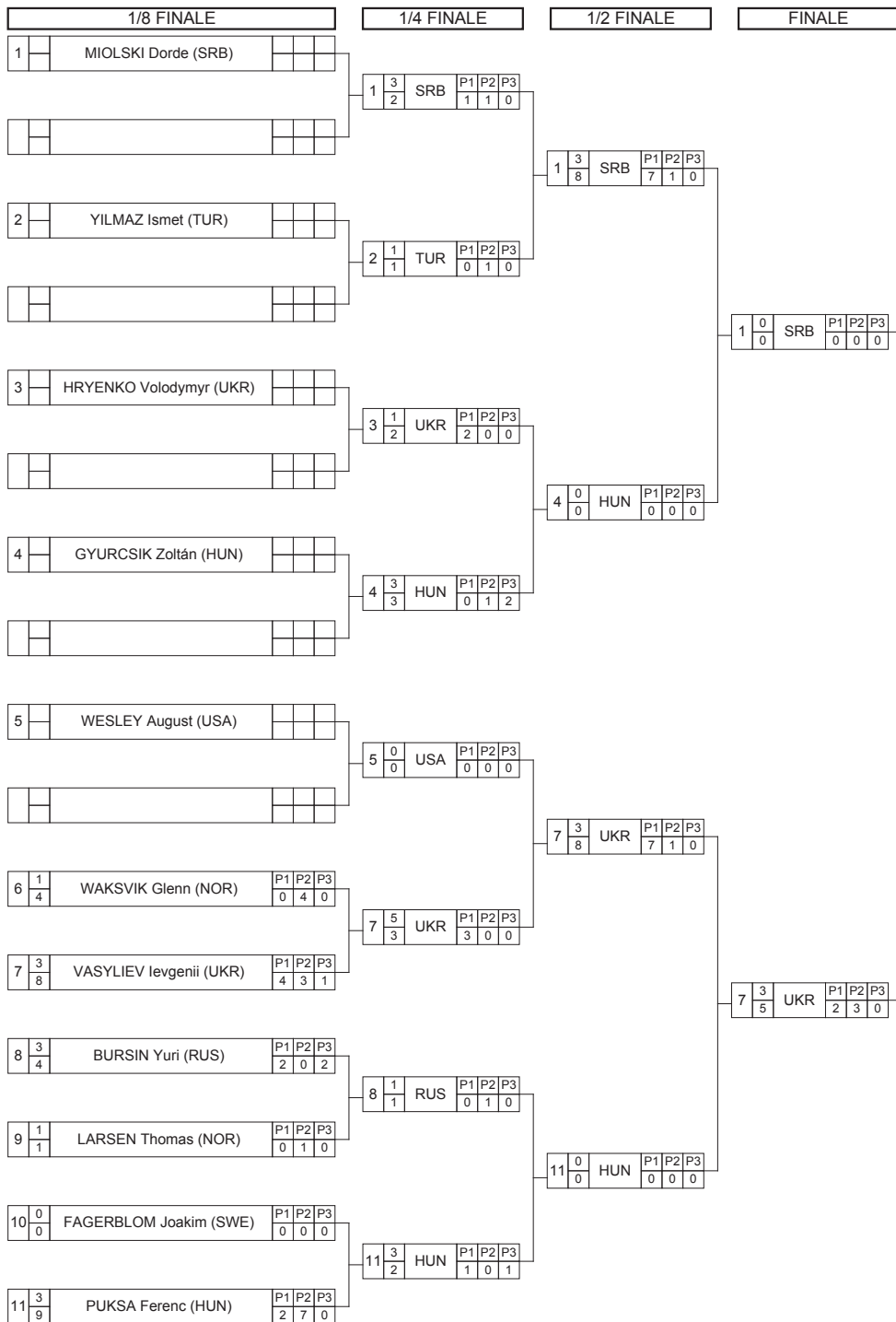

7 VASYLIEV Ievgenii (UKR)

Classement

Cl	Pays	Nom
1	UKR	VASYLIEV Ievgenii
2	SRB	MIOLSKI Dorde
3	TUR	YILMAZ Ismet
3	HUN	PUKSA Ferenc
5	HUN	GYURCSIK Zoltán
5	NOR	WAKSVIK Glenn
7	RUS	BURSIN Yuri
8	USA	WESLEY August
9	UKR	HRYENKO Volodymyr
10	NOR	LARSEN Thomas
11	SWE	FAGERBLOM Joakim

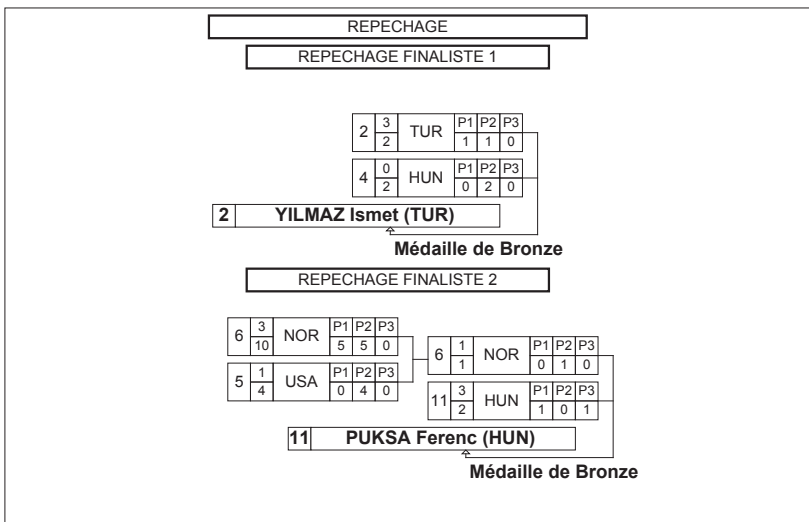



Feuille de compétition / Competition Sheet

Veteran WCH DIV A

STYLE : GR 97 kg

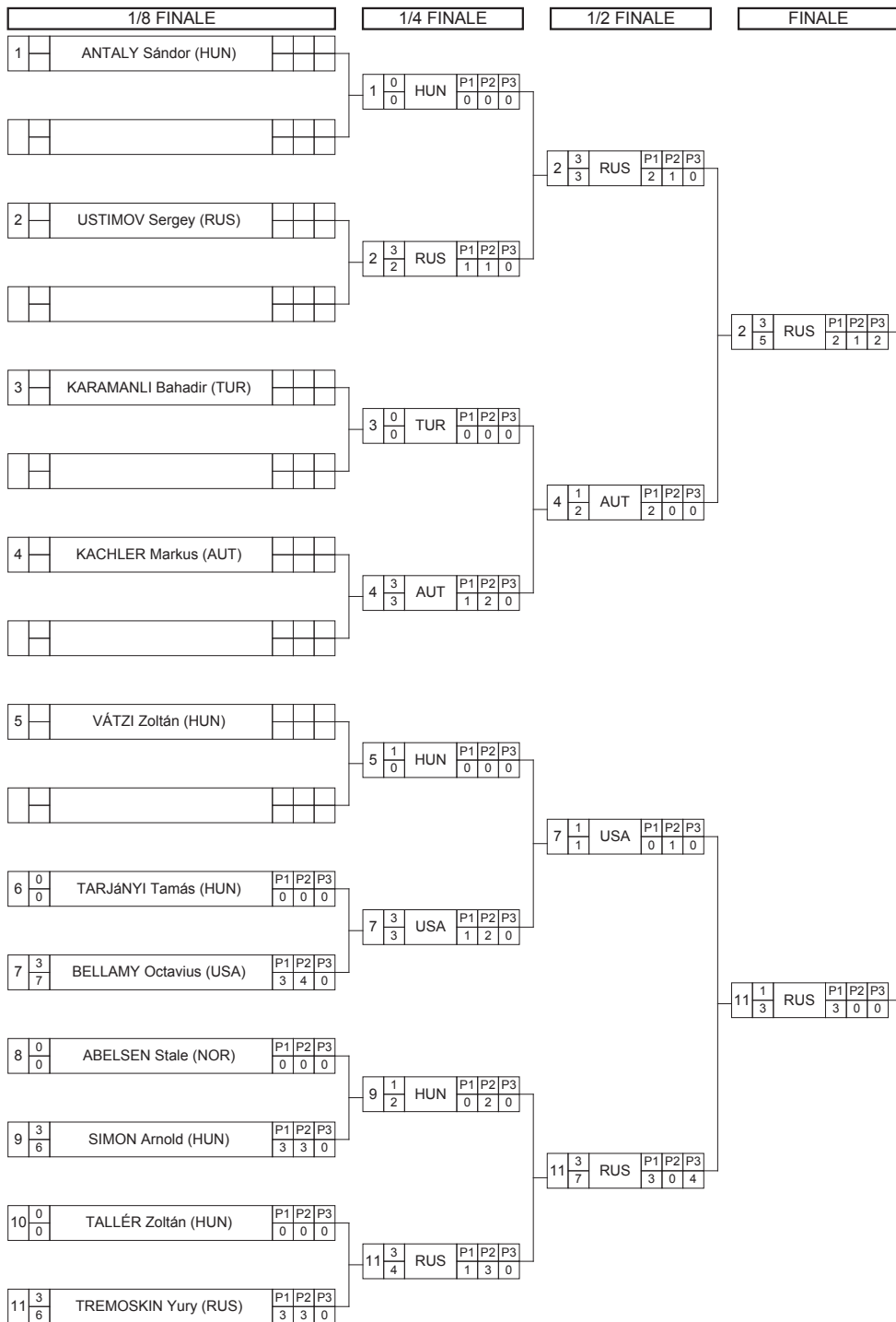

Classement

Cl	Pays	Nom
1	RUS	USTIMOV Sergey
2	RUS	TREMOSKIN Yury
3	AUT	KACHLER Markus
3	USA	BELLAMY Octavius
5	HUN	ANTALY Sándor
5	HUN	TALLÉR Zoltán
7	HUN	SIMON Arnold
8	HUN	VÁTZI Zoltán
9	TUR	KARAMANLI Bahadır
10	NOR	ABELSEN Stale
11	HUN	TARJÁNYI Tamás

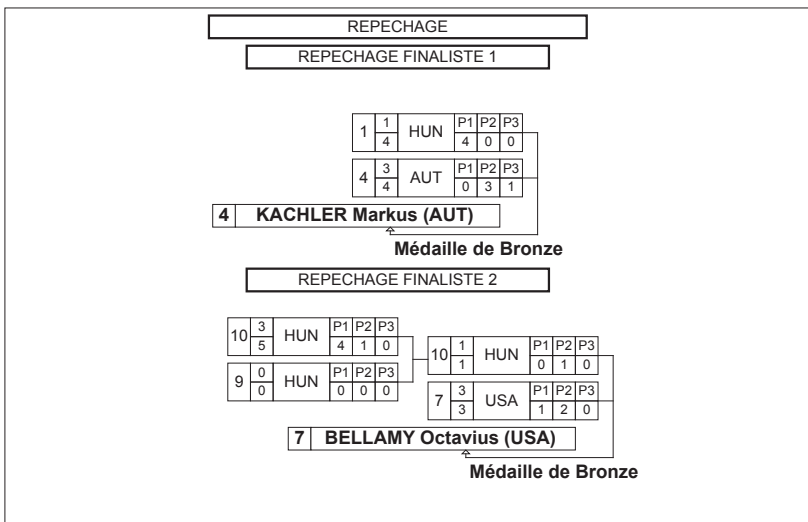



Feuille de compétition / Competition Sheet

Veteran WCH DIV A

STYLE : GR 130 kg

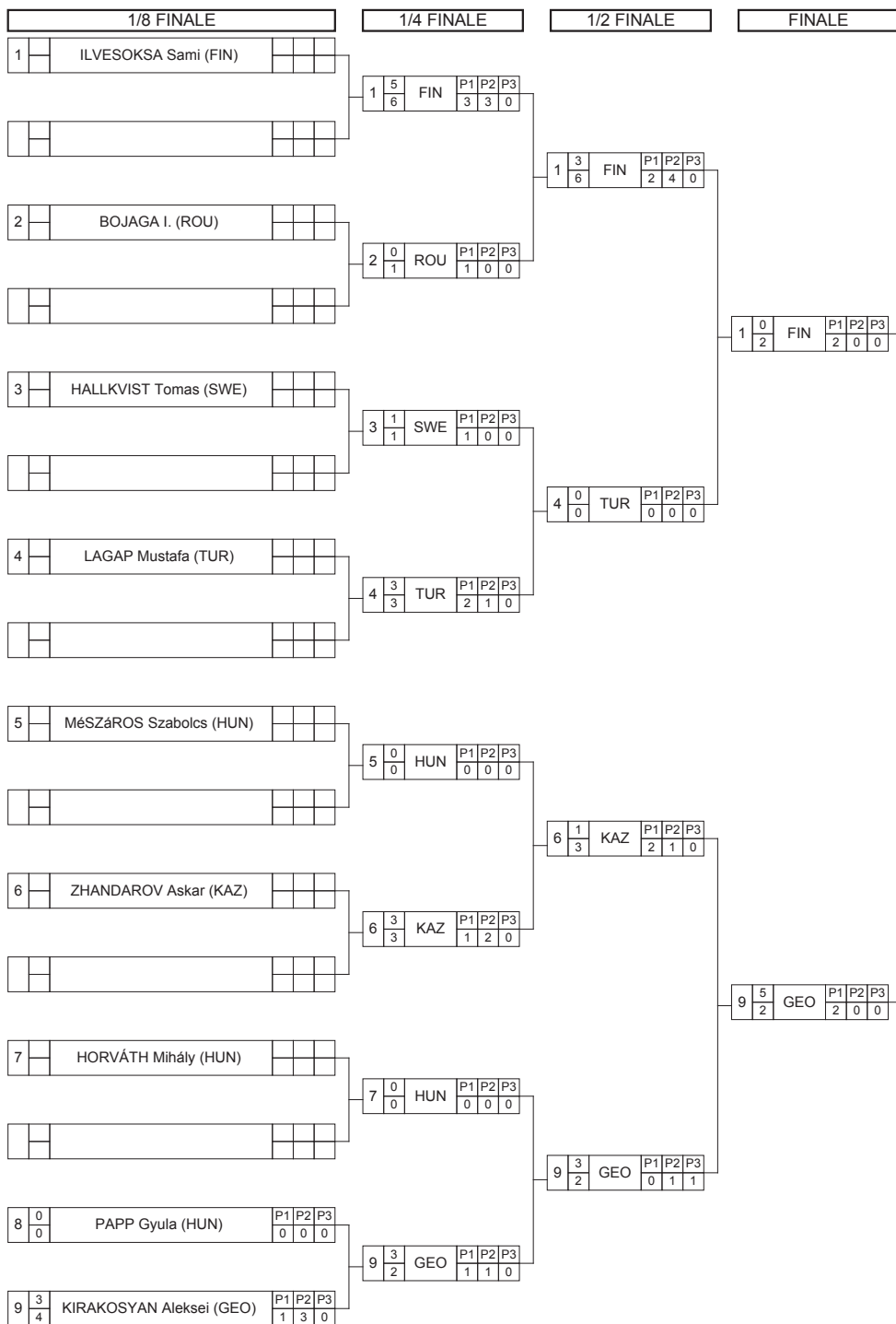

9 KIRAKOSYAN Aleksei (GEO)

Classement

Cl	Pays	Nom
1	GEO	KIRAKOSYAN Aleksei
2	FIN	ILVESOKSA Sami
3	TUR	LAGAP Mustafa
3	KAZ	ZHANDAROV Askar
5	ROU	BOJAGA Ionel-Iulian
5	HUN	PAPP Gyula
7	SWE	HALLKVIST Tomas
8	HUN	HORVÁTH Mihály
9	HUN	MéSZÁROS Szabolcs

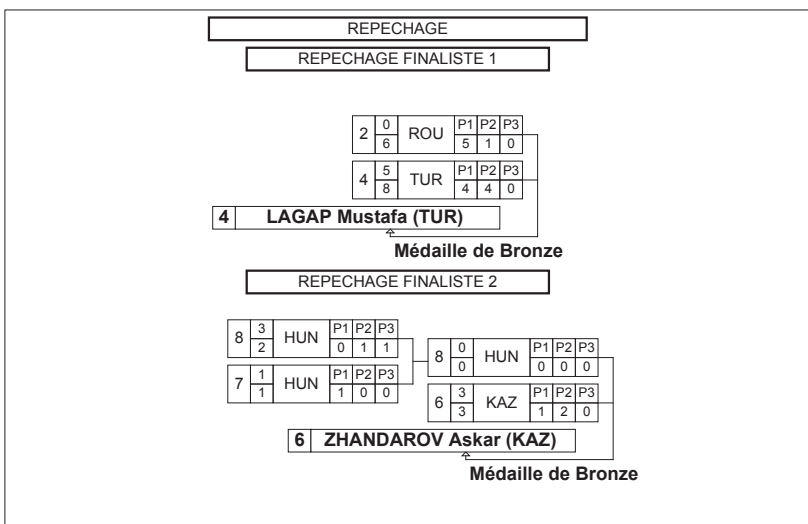



Feuille de compétition / Competition Sheet

Veteran WCH DIV B

STYLE : GR 58 kg



TOUR : 1

1	$\frac{3}{2}$	SCHULLIAN Uwe (GER)	P1	P2	P3	1	SCHULLIAN Uwe (GER)
			1	1	0		
2	$\frac{0}{0}$	KLEIST Jakob (SWE)	P1	P2	P3	0	
			0	0	0		
3	$\frac{1}{2}$	RIZVANOVIC Senad (SRB)	P1	P2	P3	1	4
			1	0	1		
4	$\frac{3}{7}$	FORNEBO Baro (NOR)	P1	P2	P3	0	4
			0	2	5		

TOUR : 2

5	$\frac{0}{0}$	SZUCSIK Tamás (HUN)	P1	P2	P3	0	1
			0	0	0		
1	$\frac{3}{8}$	SCHULLIAN Uwe (GER)	P1	P2	P3	1	1
			1	7	0		
2	$\frac{1}{3}$	KLEIST Jakob (SWE)	P1	P2	P3	3	3
			3	0	0		
3	$\frac{3}{10}$	RIZVANOVIC Senad (SRB)	P1	P2	P3	4	3
			4	6	0		

TOUR : 3

4	$\frac{3}{2}$	FORNEBO Baro (NOR)	P1	P2	P3	1	4
			1	1	0		
1	$\frac{1}{1}$	SCHULLIAN Uwe (GER)	P1	P2	P3	1	1
			1	0	0		
5	$\frac{0}{0}$	SZUCSIK Tamás (HUN)	P1	P2	P3	0	2
			0	0	0		
2	$\frac{4}{0}$	KLEIST Jakob (SWE)	P1	P2	P3	0	2
			0	0	0		

TOUR : 4

3	$\frac{1}{3}$	RIZVANOVIC Senad (SRB)	P1	P2	P3	1	1
			1	2	0		
1	$\frac{3}{2}$	SCHULLIAN Uwe (GER)	P1	P2	P3	1	1
			1	0	1		
4	$\frac{4}{0}$	FORNEBO Baro (NOR)	P1	P2	P3	0	4
			0	0	0		
5	$\frac{0}{0}$	SZUCSIK Tamás (HUN)	P1	P2	P3	0	5
			0	0	0		

TOUR : 5

2	$\frac{1}{1}$	KLEIST Jakob (SWE)	P1	P2	P3	0	4
			0	1	0		
4	$\frac{3}{2}$	FORNEBO Baro (NOR)	P1	P2	P3	1	4
			1	0	1		
3	$\frac{4}{0}$	RIZVANOVIC Senad (SRB)	P1	P2	P3	0	3
			0	0	0		
5	$\frac{0}{0}$	SZUCSIK Tamás (HUN)	P1	P2	P3	0	5
			0	0	0		

Classement

Cl	Pays	Nom	Points
1	NOR	FORNEBO Baro	13
2	GER	SCHULLIAN Uwe	10
3	SRB	RIZVANOVIC Senad	9
4	SWE	KLEIST Jakob	6
5	HUN	SZUCSIK Tamás	0



Feuille de compétition / Competition Sheet

Veteran WCH DIV B

STYLE : GR 63 kg

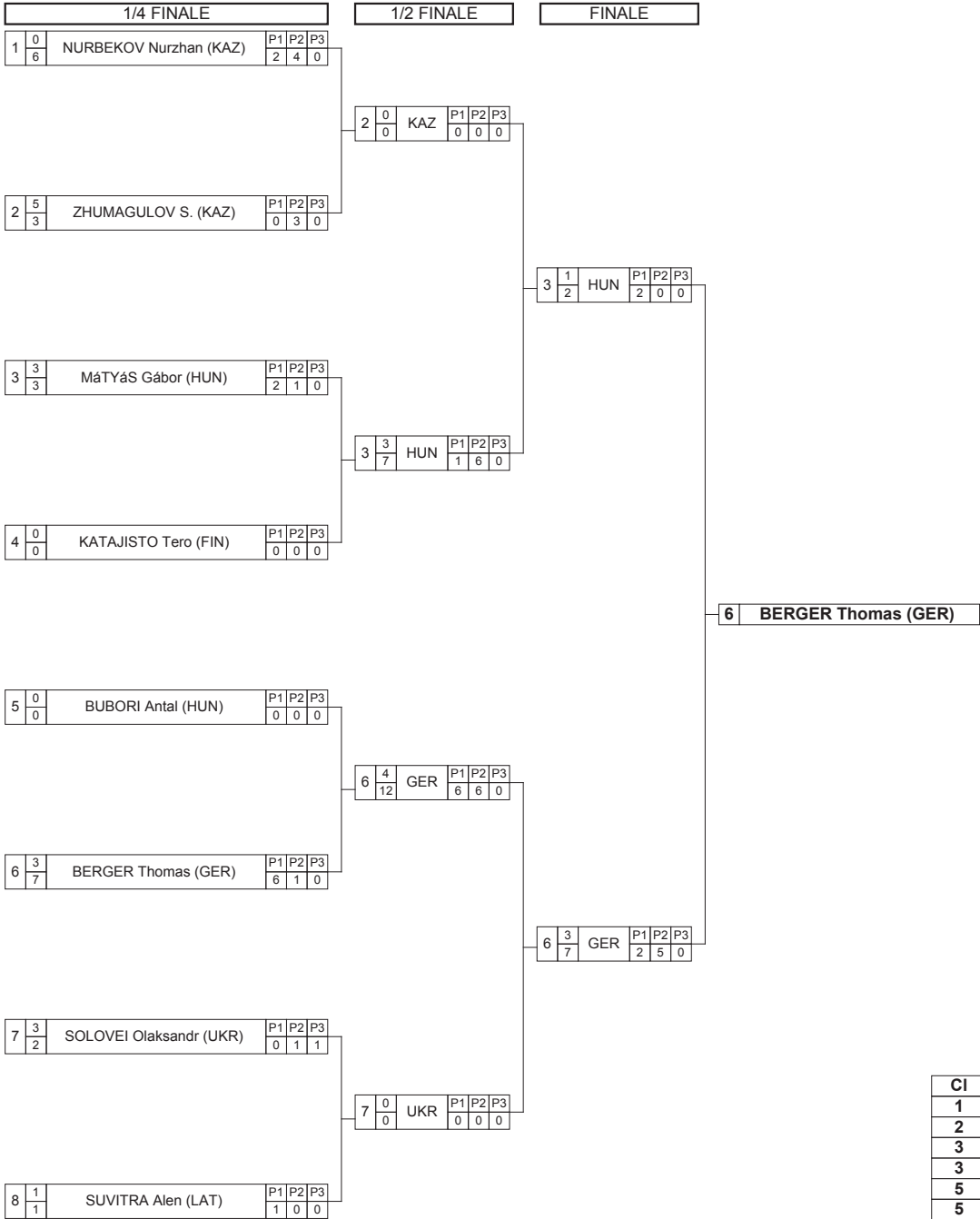
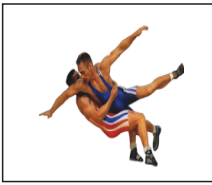

Classement

Cl	Pays	Nom
1	GER	BERGER Thomas
2	HUN	MáTYÁS Gábor
3	FIN	KATAJISTO Tero
3	UKR	SOLOVEI Olaksandr
5	KAZ	ZHUMAGULOV S.
5	HUN	BUBORI Antal
7	LAT	SUVITRA Alen
8	KAZ	NURBEKOV Nurzhan

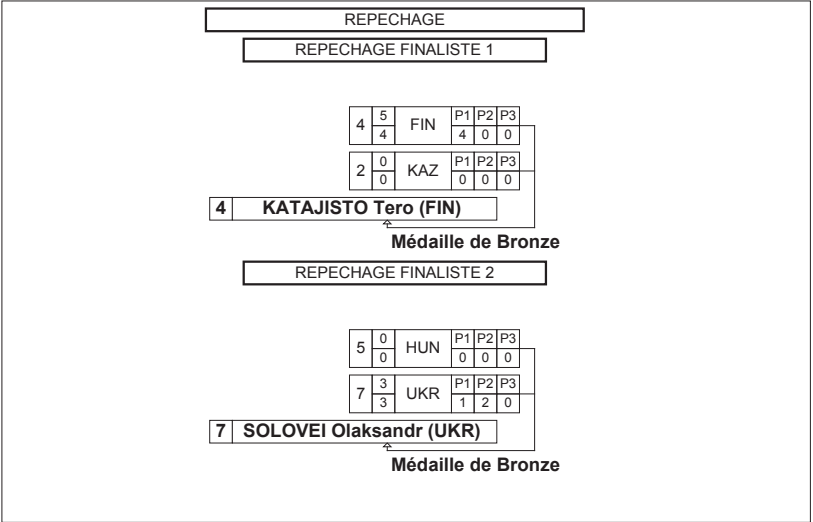



Feuille de compétition / Competition Sheet

Veteran WCH DIV B



STYLE : GR 69 kg

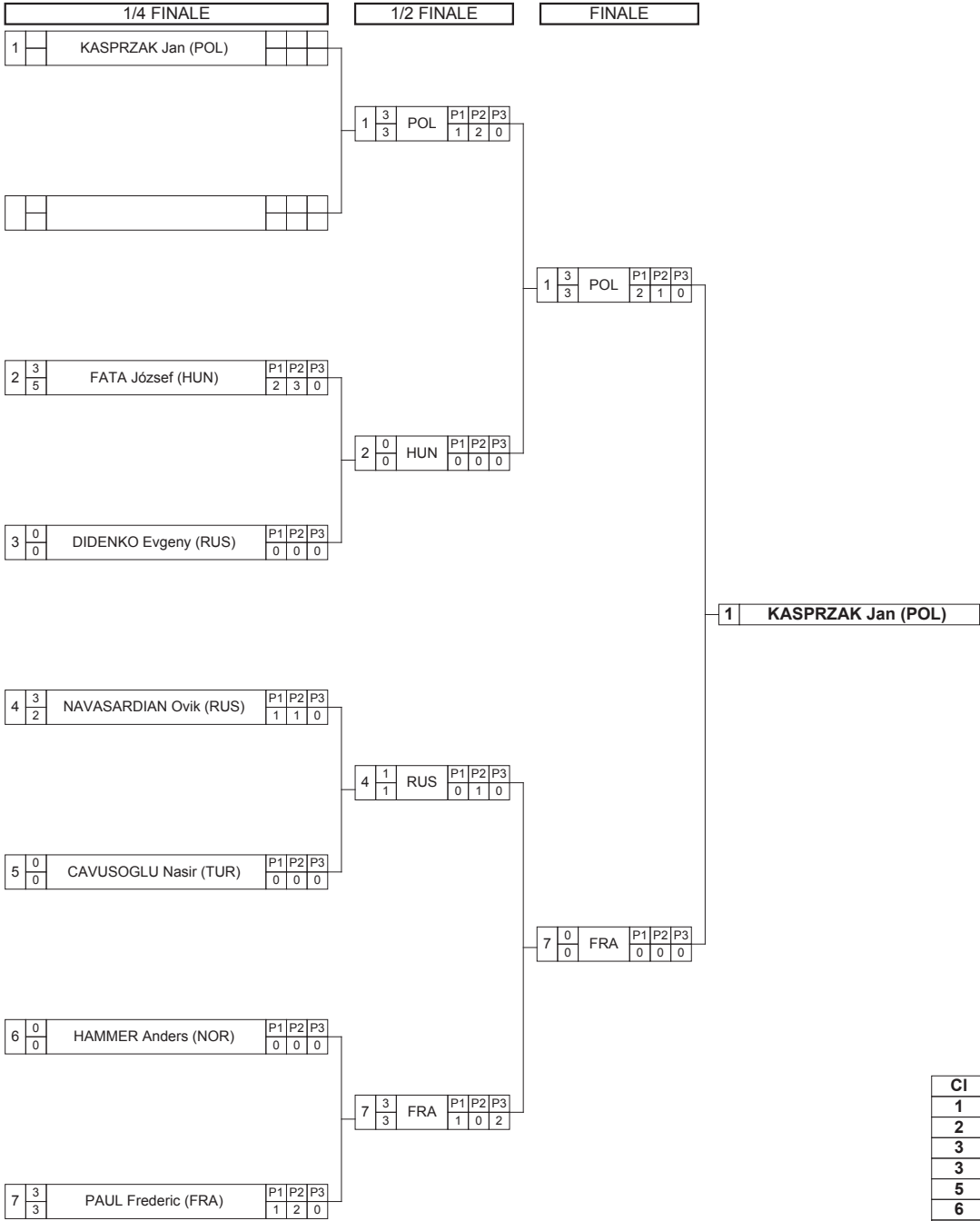

Classement

Cl	Pays	Nom
1	POL	KASPRZAK Jan
2	FRA	PAUL Frederic
3	HUN	FATA József
3	RUS	NAVASARDIAN Ovik
5	NOR	HAMMER Anders
6	TUR	CAVUSOGLU Nasir
7	RUS	DIDENKO Evgeny

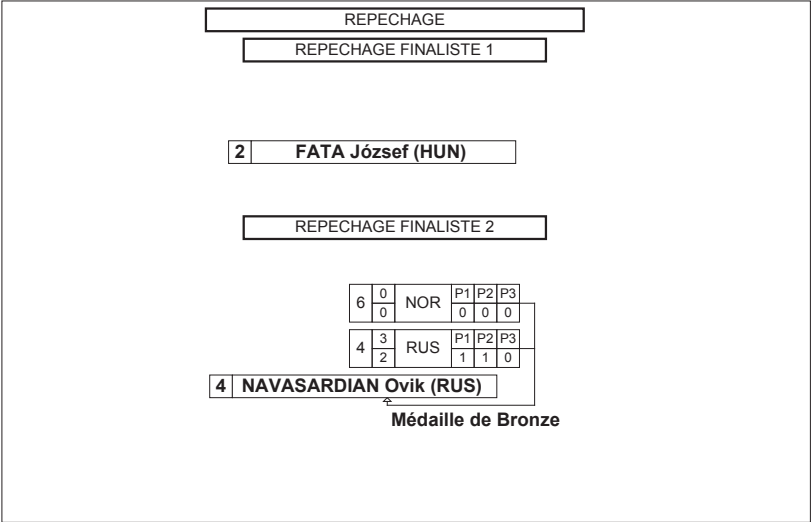



Feuille de compétition / Competition Sheet

Veteran WCH DIV B

STYLE : GR 76 kg



1 JOVETZKO Adam (GER)

Classement

Cl	Pays	Nom
1	GER	JOVETZKO Adam
2	SWE	SJÖQVIST Roger
3	RUS	SOKOLOV Vladimir
3	TUR	BEKISDAMAT Ergüder
5	TUR	AYYILDIZ Ercan
5	SWE	OLSSON Niklas
7	NOR	MELUM Jorn
8	RUS	TATARINTCEV Aleksey
9	UKR	LOZHECHKA Oleksii
10	HUN	KAJTÁN László
11	KAZ	CHSHERBAKOV A.
12	TUR	YILDIRIM Erkan
13	FRA	YON Gilles
13	KAZ	BULLAKH Dmitryi
15	HUN	MOLNÁR József

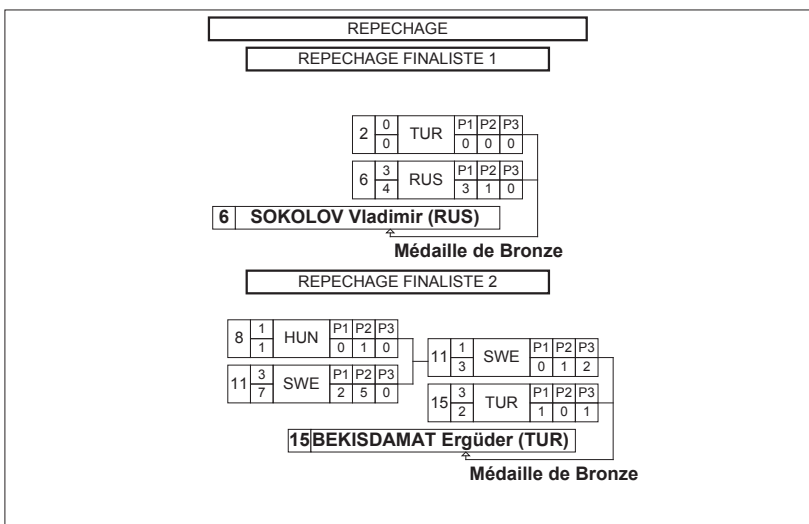



Feuille de compétition / Competition Sheet

Veteran WCH DIV B

STYLE : FS 85 kg



QUALIFICATION		1/8 FINALE		1/4 FINALE		1/2 FINALE		FINALE	
1	DEMIREGEN Muharrem (TUR)	1	0 0	TUR	P1 0	P2 0	P3 0		
2	QULIYEV Islam (AZE)	2	3 2	AZE	P1 1	P2 1	P3 0		
3	BABAK HEIDARI (IRI)	3	1 3	IRI	P1 3	P2 0	P3 0		
4	DE BEER Matthys (RSA)	4	3 6	RSA	P1 1	P2 1	P3 4		
5	SCHYCK Michael (USA)	5	5 10	USA	P1 6	P2 4	P3 0		
6	JANKOVICS Péter (HUN)	6	0 0	HUN	P1 0	P2 0	P3 0		
7	PINE Kevin (USA)	7	5 14	USA	P1 7	P2 7	P3 0		
8	ILYASOV Memet (UKR)	8	0 0	UKR	P1 0	P2 0	P3 0		
9	ASHYRALIEV Yaver (RUS)	9	5 10	RUS	P1 7	P2 3	P3 0		
10	SCHUCH W. (AUT)	10	0 0	AUT	P1 0	P2 0	P3 0		
11	SIPOS Zsolt (HUN)	11	1 7	HUN	P1 2	P2 3	P3 2		
12	BULAKH Dmitriy (KAZ)	12	3 10	KAZ	P1 2	P2 3	P3 5		
13	MEDZHIDOV Shokhrat (RUS)	13	1 1	RUS	P1 0	P2 1	P3 0		
14	POGORELOV Sergey (RUS)	14	3 2	RUS	P1 0	P2 1	P3 1		
15	KULICH Borys (USA)	15	0 1	USA	P1 1	P2 0	P3 0		
16	LUKÁCS Imre (HUN)	16	3 3	HUN	P1 2	P2 1	P3 0		
17	POPESCU Adrian (ROU)	17	0 0	ROU	P1 0	P2 0	P3 0		
18	BORISOV Evgenij (LAT)	18	0 0	LAT	P1 0	P2 0	P3 0		
19	SIPEKI Károly (HUN)	19	5 5	HUN	P1 1	P2 4	P3 0		

5 SCHYCK Michael (USA)

Classement

Cl	Pays	Nom
1	USA	SCHYCK Michael
2	RUS	POGORELOV Sergey
3	USA	PINE Kevin
3	USA	KULICH Borys
5	RSA	DE BEER Matthys
5	RUS	ASHYRALIEV Yaver
7	HUN	LUKÁCS Imre
8	HUN	SIPEKI Károly
9	AZE	QULIYEV Islam
10	KAZ	BULAKH Dmitriy
11	HUN	SIPOS Zsolt
12	IRI	BABAK HEIDARI
13	RUS	MEDZHIDOV Shokhrat
14	TUR	DEMIREGEN Muharrem
15	ROU	POPESCU Adrian
16	LAT	BORISOV Evgenij
17	AUT	SCHUCH W.
18	UKR	ILYASOV Memet
19	HUN	JANKOVICS Péter

REPECHAGE	
REPECHAGE FINALISTE 1	
6	0 0
7	4 14
7	3 10
4	1 1
7	PINE Kevin (USA)
Médaille de Bronze	
REPECHAGE FINALISTE 2	
15	5 5
13	0 0
15	3 4
16	0 0
9	1 1
15	KULICH Borys (USA)
Médaille de Bronze	



Feuille de compétition / Competition Sheet

Veteran WCH DIV B

STYLE : GR 97 kg



TOUR : 1

1	0 0	MIKHAYLOV Grigory (RUS)	P1 0	P2 0	P3 0	2	KETONEN Jussi (FIN)
2	3 3	KETONEN Jussi (FIN)	P1 1	P2 2	P3 0		
3	0 0	LEMÁK Gábor (HUN)	P1 0	P2 0	P3 0	4	MEDVEDEV Boris (RUS)
4	4 4	MEDVEDEV Boris (RUS)	P1 1	P2 3	P3 0		

TOUR : 2

5	0 0	MURTUZOV Telman (RUS)	P1 0	P2 0	P3 0	1	MIKHAYLOV Grigory (RUS)
1	3 2	MIKHAYLOV Grigory (RUS)	P1 1	P2 1	P3 0		
2	3 2	KETONEN Jussi (FIN)	P1 1	P2 1	P3 0	2	KETONEN Jussi (FIN)
3	0 0	LEMÁK Gábor (HUN)	P1 0	P2 0	P3 0		

TOUR : 3

4	3 8	MEDVEDEV Boris (RUS)	P1 1	P2 7	P3 0	4	MEDVEDEV Boris (RUS)
1	0 0	MIKHAYLOV Grigory (RUS)	P1 0	P2 0	P3 0		
5	0 0	MURTUZOV Telman (RUS)	P1 0	P2 0	P3 0	2	KETONEN Jussi (FIN)
2	3 2	KETONEN Jussi (FIN)	P1 1	P2 1	P3 0		

TOUR : 4

3	0 7	LEMÁK Gábor (HUN)	P1 7	P2 0	P3 0	1	MIKHAYLOV Grigory (RUS)
1	4 5	MIKHAYLOV Grigory (RUS)	P1 0	P2 2	P3 3		
4	3 11	MEDVEDEV Boris (RUS)	P1 7	P2 4	P3 0	4	MEDVEDEV Boris (RUS)
5	0 0	MURTUZOV Telman (RUS)	P1 0	P2 0	P3 0		

TOUR : 5

2	0 0	KETONEN Jussi (FIN)	P1 0	P2 0	P3 0	4	MEDVEDEV Boris (RUS)
4	3 7	MEDVEDEV Boris (RUS)	P1 1	P2 6	P3 0		
3	0 0	LEMÁK Gábor (HUN)	P1 0	P2 0	P3 0	5	MURTUZOV Telman (RUS)
5	4 1	MURTUZOV Telman (RUS)	P1 1	P2 0	P3 0		

Classement

Cl	Pays	Nom	Points
1	RUS	MEDVEDEV Boris	13
2	FIN	KETONEN Jussi	9
3	RUS	MIKHAYLOV Grigory	7
4	RUS	MURTUZOV Telman	4
5	HUN	LEMÁK Gábor	0



Feuille de compétition / Competition Sheet

Veteran WCH DIV B

STYLE : GR 130 kg

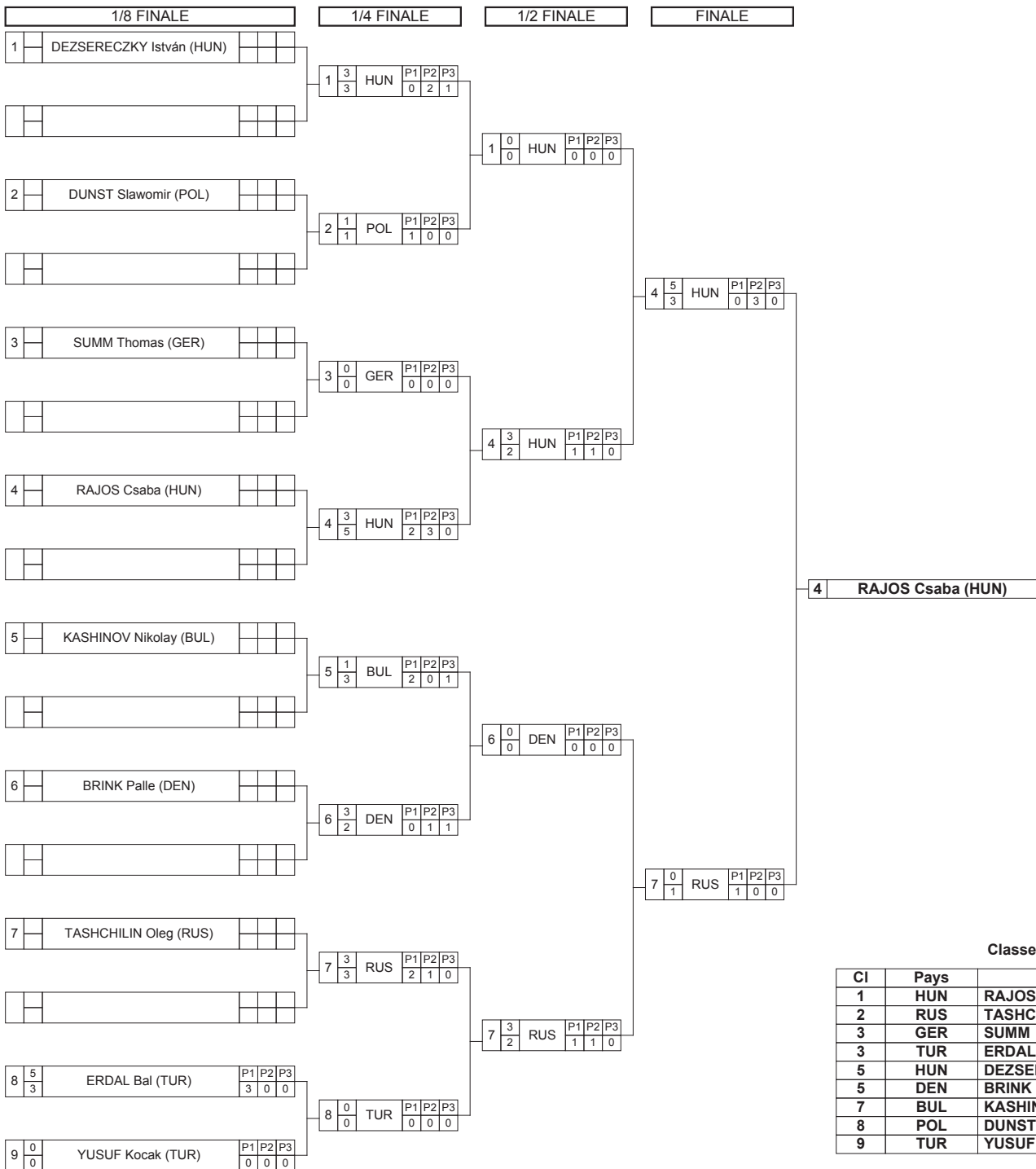

Classement

Cl	Pays	Nom
1	HUN	RAJOS Csaba
2	RUS	TASHCHILIN Oleg
3	GER	SUMM Thomas
3	TUR	ERDAL Bal
5	HUN	DEZSERECZKY István
5	DEN	BRINK Palle
7	BUL	KASHINOV Nikolay
8	POL	DUNST Slawomir
9	TUR	YUSUF Kocak

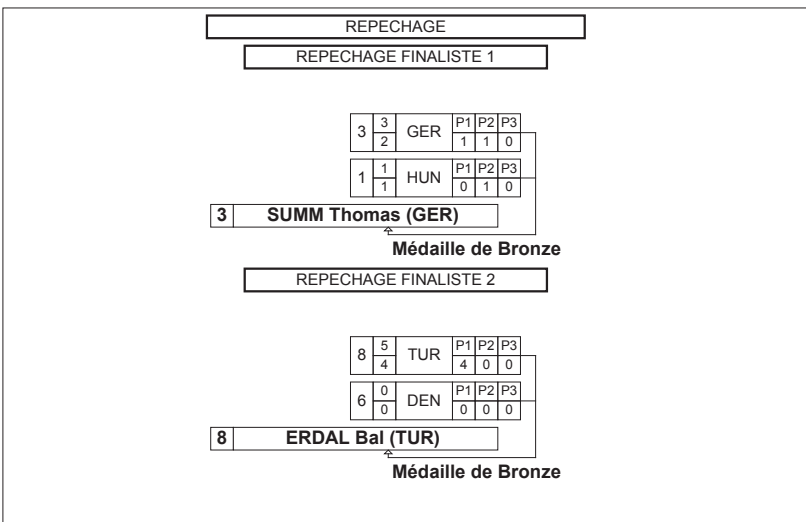



Feuille de compétition / Competition Sheet

Veteran WCH DIV C

STYLE : GR 58 kg



TOUR : 1

1	1 1	AYBAR Victor (USA)	P1 0	P2 1	P3 0	2	RAKHMANGULOV Ramil (RUS)
2	3 10	RAKHMANGULOV Ramil (RUS)	P1 3	P2 7	P3 0		
3	0 2	JALALI Asadollah (IRI)	P1 0	P2 2	P3 0	4	CHUEV Igor (RUS)
4	4 4	CHUEV Igor (RUS)	P1 1	P2 3	P3 0		

TOUR : 2

1	1 2	AYBAR Victor (USA)	P1 2	P2 0	P3 0	3	JALALI Asadollah (IRI)
3	3 8	JALALI Asadollah (IRI)	P1 2	P2 6	P3 0		
2	3 6	RAKHMANGULOV Ramil (RUS)	P1 4	P2 1	P3 1	2	RAKHMANGULOV Ramil (RUS)
4	1 4	CHUEV Igor (RUS)	P1 0	P2 4	P3 0		

TOUR : 3

1	0 4	AYBAR Victor (USA)	P1 4	P2 0	P3 0	4	CHUEV Igor (RUS)
4	4 4	CHUEV Igor (RUS)	P1 1	P2 3	P3 0		
2	3 4	RAKHMANGULOV Ramil (RUS)	P1 3	P2 1	P3 0	2	RAKHMANGULOV Ramil (RUS)
3	0 0	JALALI Asadollah (IRI)	P1 0	P2 0	P3 0		

Classement

Cl	Pays	Nom	Points
1	RUS	RAKHMANGULOV Ramil	9
2	RUS	CHUEV Igor	9
3	IRI	JALALI Asadollah	3
4	USA	AYBAR Victor	2



Feuille de compétition / Competition Sheet

Veteran WCH DIV C

STYLE : GR 63 kg

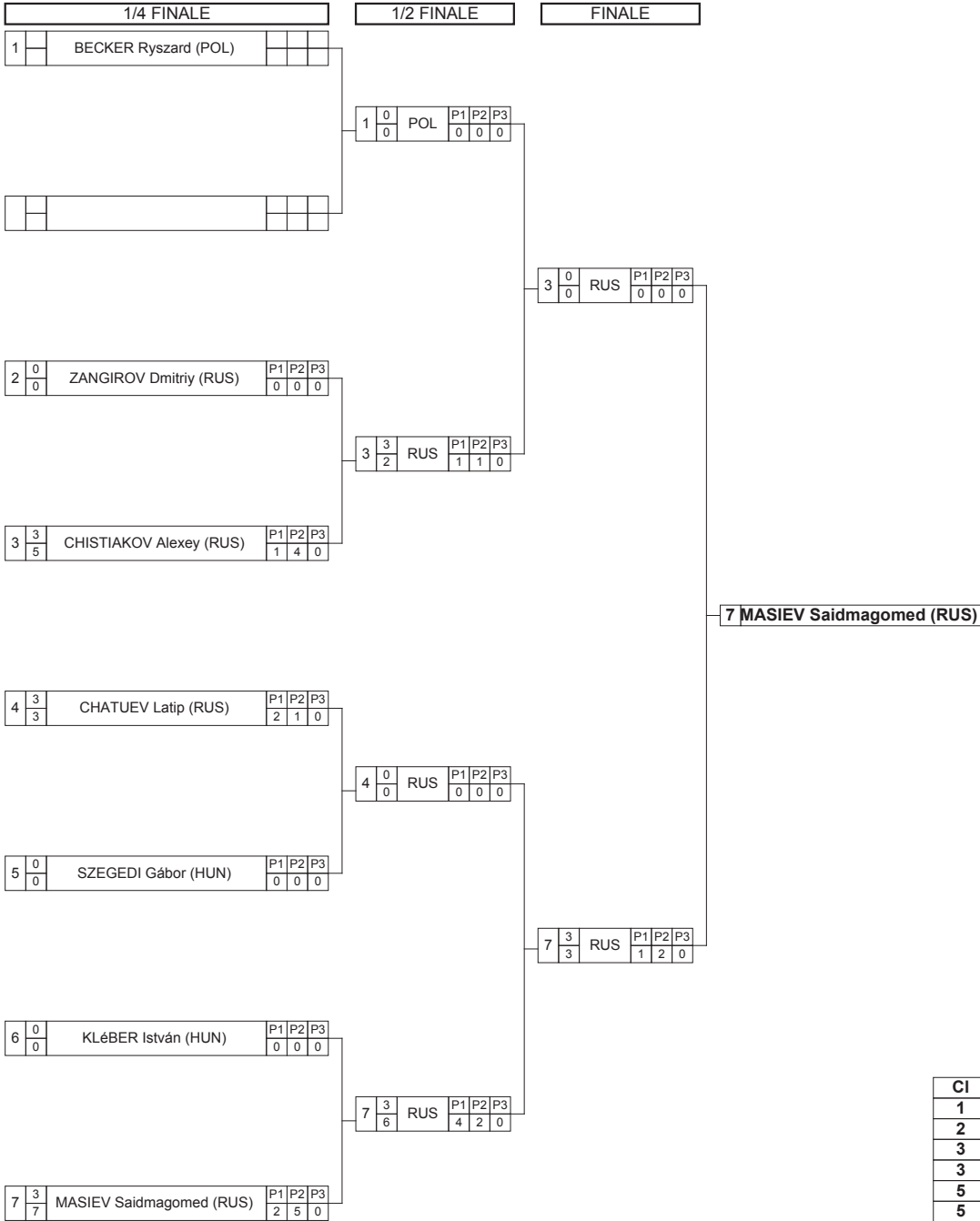

Classement

Cl	Pays	Nom
1	RUS	MASIEV Saidmagomed
2	RUS	CHISTIAKOV Alexey
3	RUS	ZANGIROV Dmitry
3	RUS	CHATUEV Latip
5	POL	BECKER Ryszard
5	HUN	KLÉBER István
7	HUN	SZEGEDI Gábor

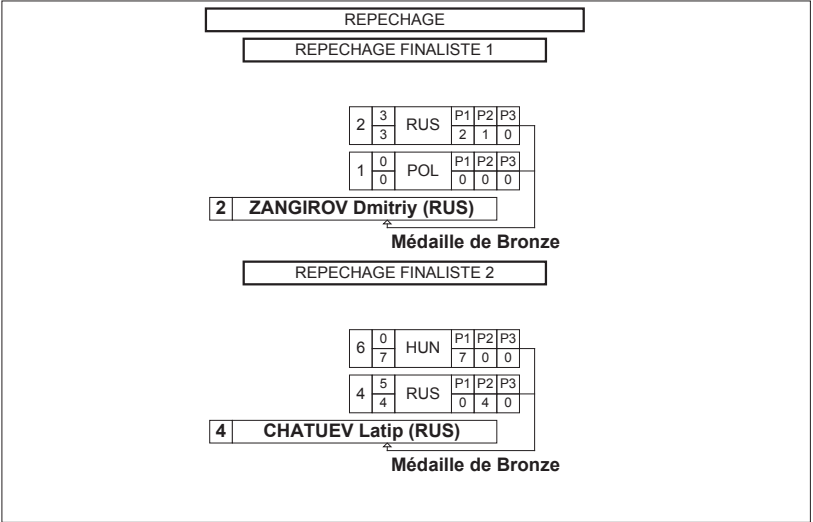



Feuille de compétition / Competition Sheet

Veteran WCH DIV C

STYLE : GR 69 kg

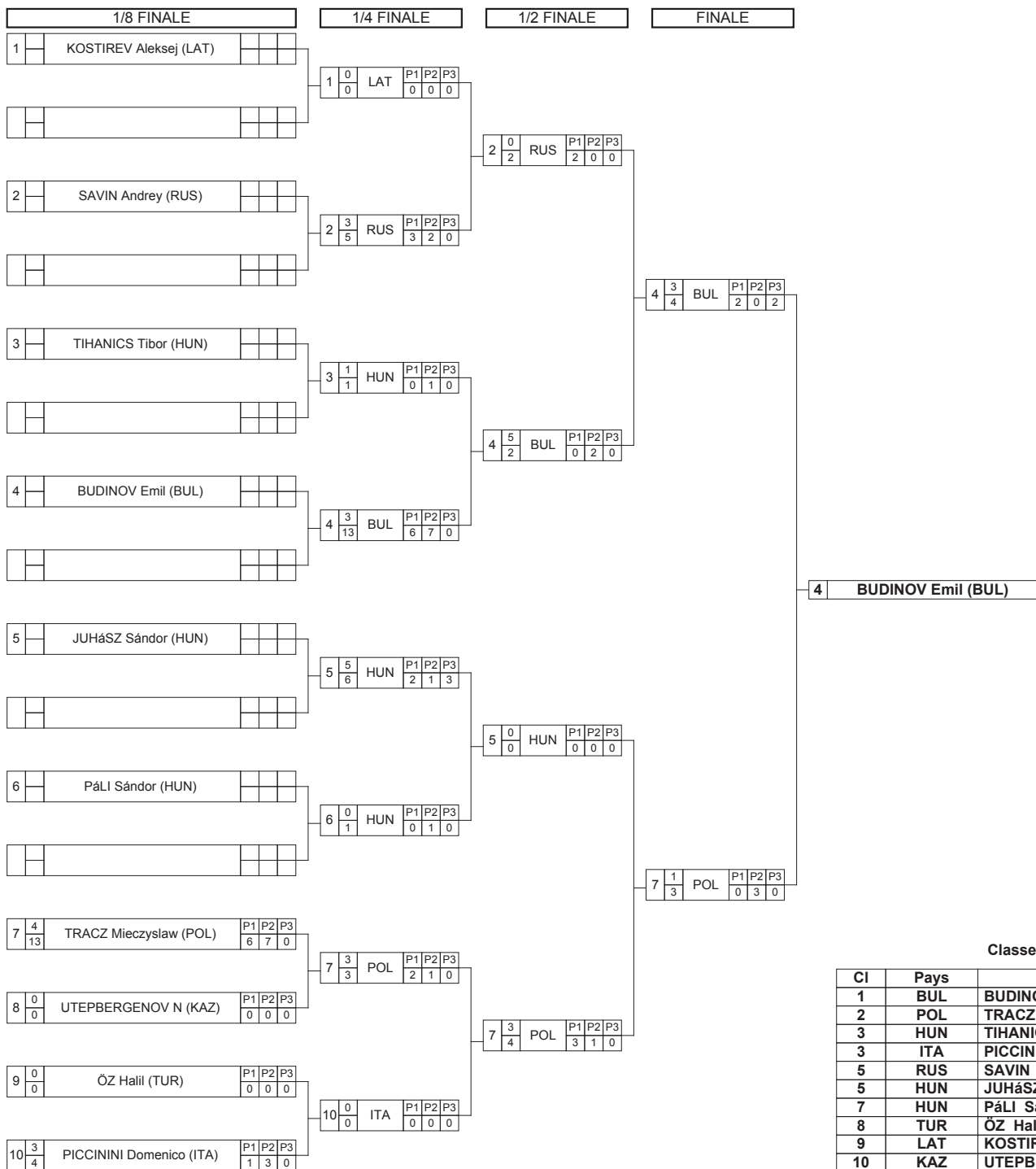

Classement

Cl	Pays	Nom
1	BUL	BUDINOV Emil
2	POL	TRACZ Mieczyslaw
3	HUN	TIHANICS Tibor
3	ITA	PICCININI Domenico
5	RUS	SAVIN Andrey
5	HUN	JUHÁSZ Sándor
7	HUN	PÁLI Sándor
8	TUR	ÖZ Halil
9	LAT	KOSTIREV Aleksej
10	KAZ	UTEPPERGENOV N

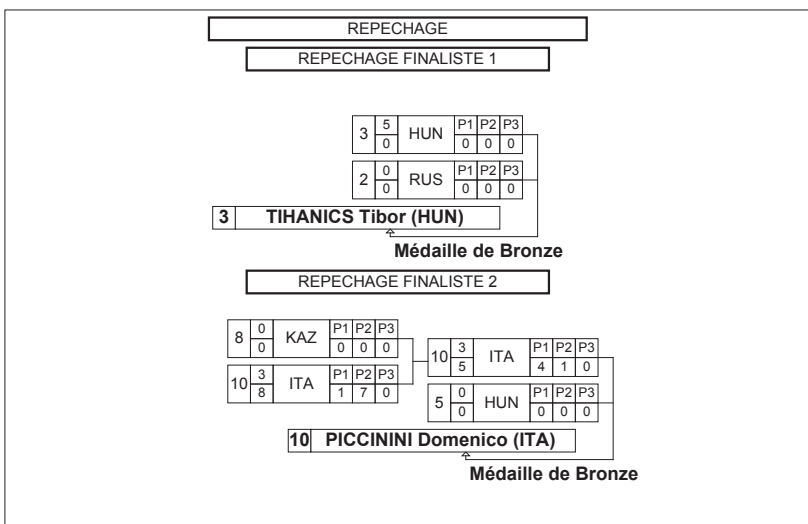



Feuille de compétition / Competition Sheet

Veteran WCH DIV C

STYLE : GR 76 kg

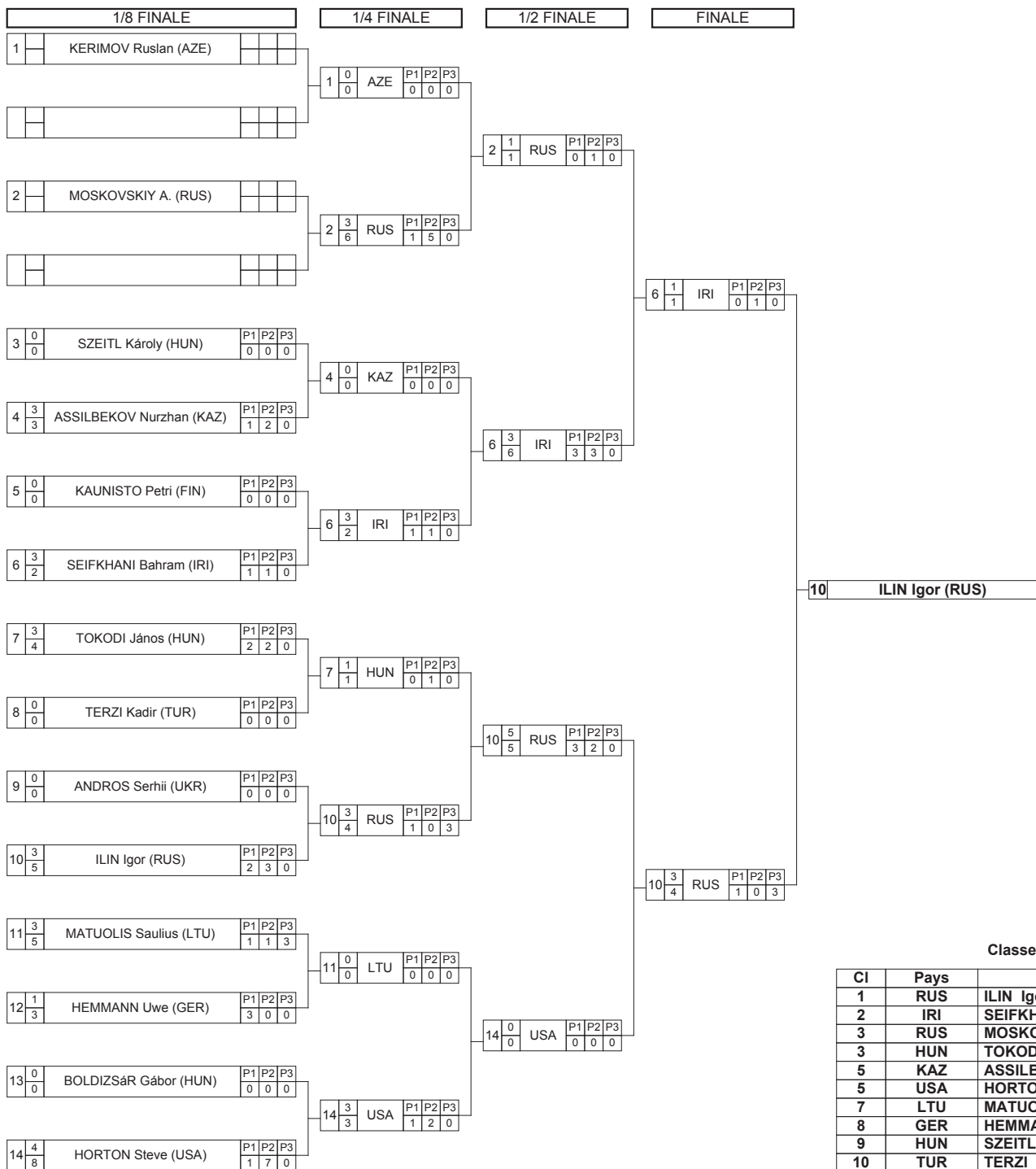

Classement

Cl	Pays	Nom
1	RUS	ILIN Igor
2	IRI	SEIFKHANI Bahram
3	RUS	MOSKOVSKIY A.
3	HUN	TOKODI János
5	KAZ	ASSILBEKOV Nurzhan
5	USA	HORTON Steve
7	LTU	MATUOLIS Saulius
8	GER	HEMMANN Uwe
9	HUN	SZEITL Károly
10	TUR	TERZI Kadir
11	AZE	KERIMOV Ruslan
11	FIN	KAUNISTO Petri
13	HUN	BOLDIZSÁR Gábor
14	UKR	ANDROS Serhii

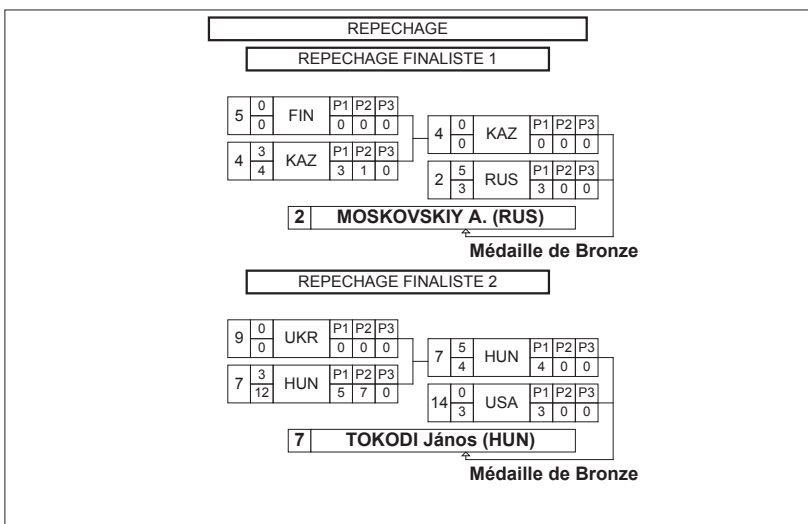



Feuille de compétition / Competition Sheet

Veteran WCH DIV C

STYLE : GR 85 kg



Classement

Cl	Pays	Nom
1	RUS	OVDIN Gennady
2	RUS	KANTORSHCHIKOV Yury
3	HUN	LAKATOS Gy?z?
3	SWE	NEJAD Arastoo
5	RUS	POPOV Dmitriy
5	UKR	DUSHKEVICH V.
7	KAZ	ZHANPEISOV K.
8	TUR	MEHMET Ali
9	POL	BLAUTENBERG Leszek
10	KAZ	BUKPANOV Kainarbek
11	TUR	ARSLAN Ilhami

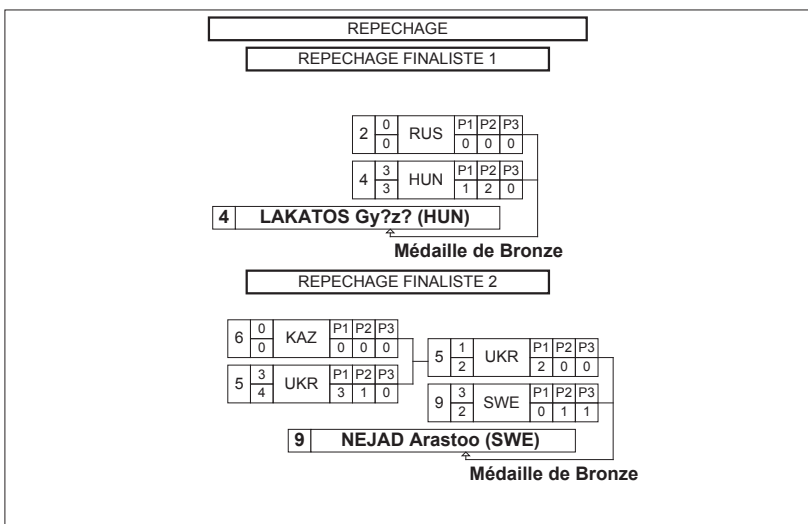



Feuille de compétition / Competition Sheet

Veteran WCH DIV C

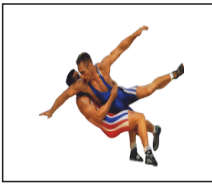

STYLE : GR 97 kg

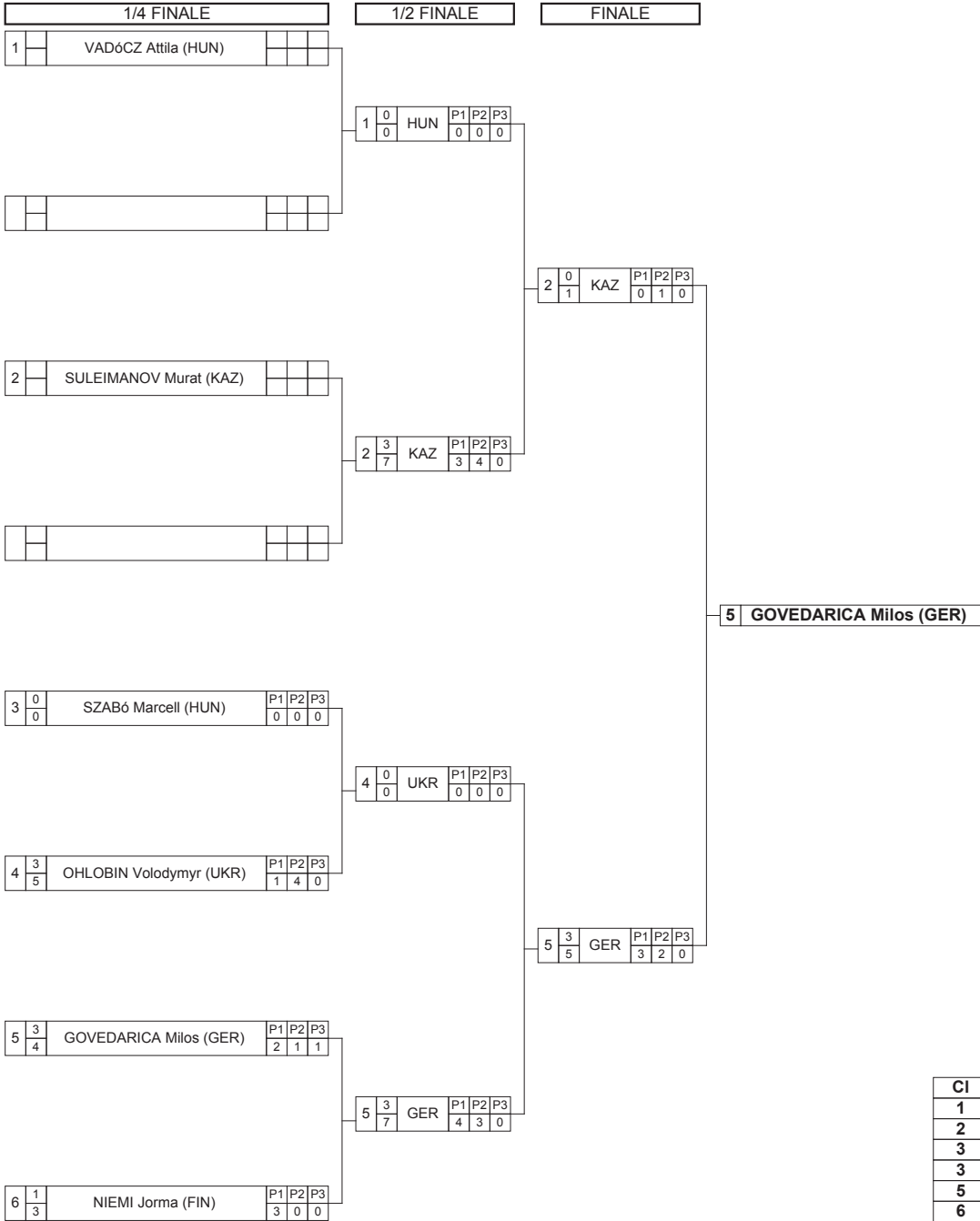

Classement

Cl	Pays	Nom
1	GER	GOVEDARICA Milos
2	KAZ	SULEIMANOV Murat
3	HUN	VADÓCZ Attila
3	UKR	OHLOBIN Volodymyr
5	FIN	NIEMI Jorma
6	HUN	SZABÓ Marcell

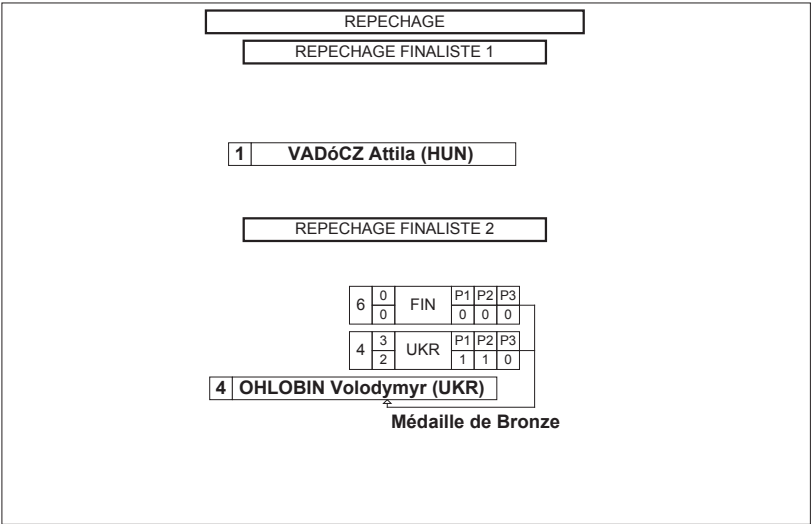



Feuille de compétition / Competition Sheet

Veteran WCH DIV C

STYLE : GR 130 kg

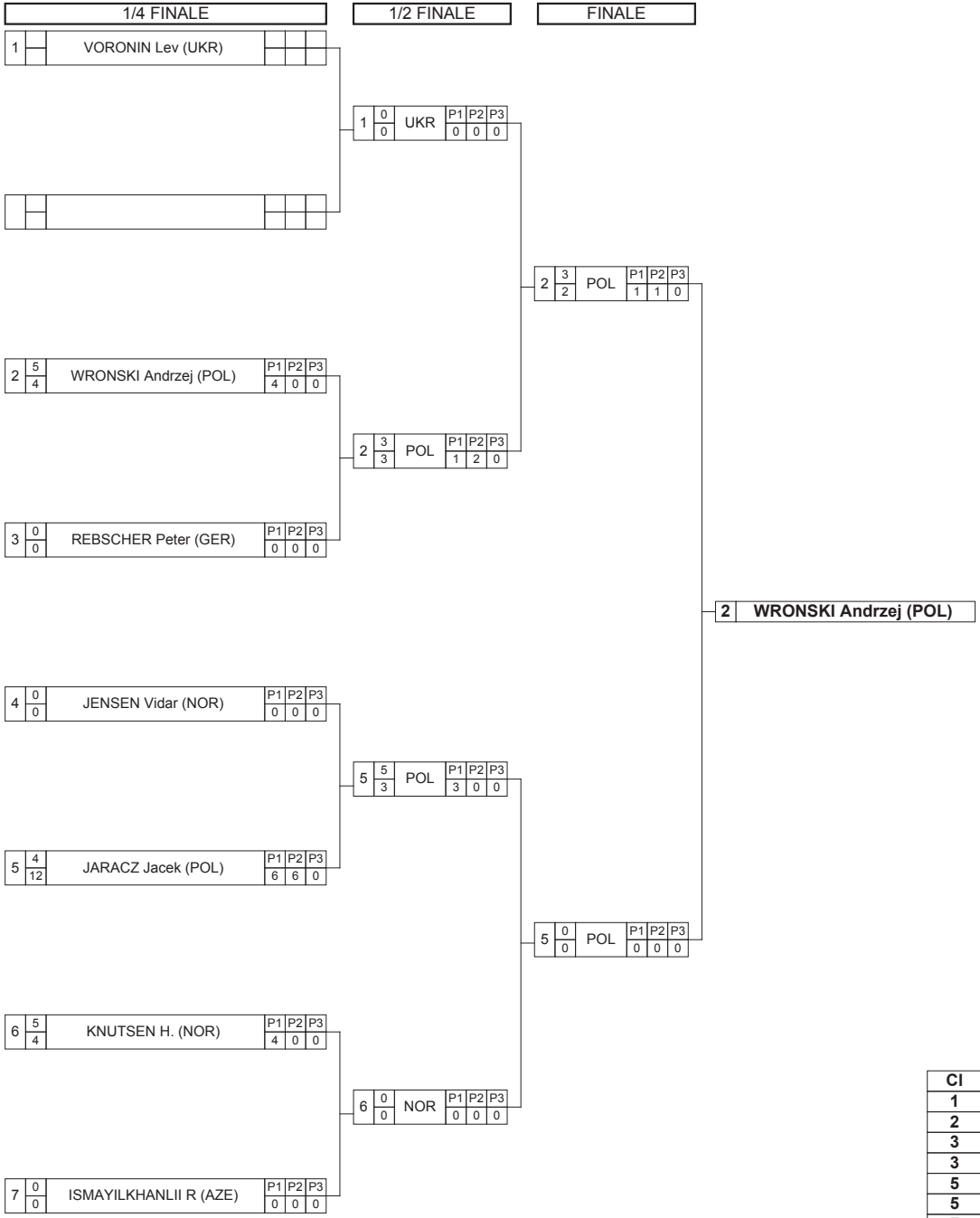
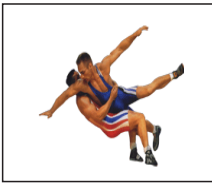

Classement

Cl	Pays	Nom
1	POL	WRONSKI Andrzej
2	POL	JARACZ Jacek
3	UKR	VORONIN Lev
3	NOR	KNUTSEN H.
5	GER	REBSCHER Peter
5	NOR	JENSEN Vidar
7	AZE	ISMAYILKHANLII R

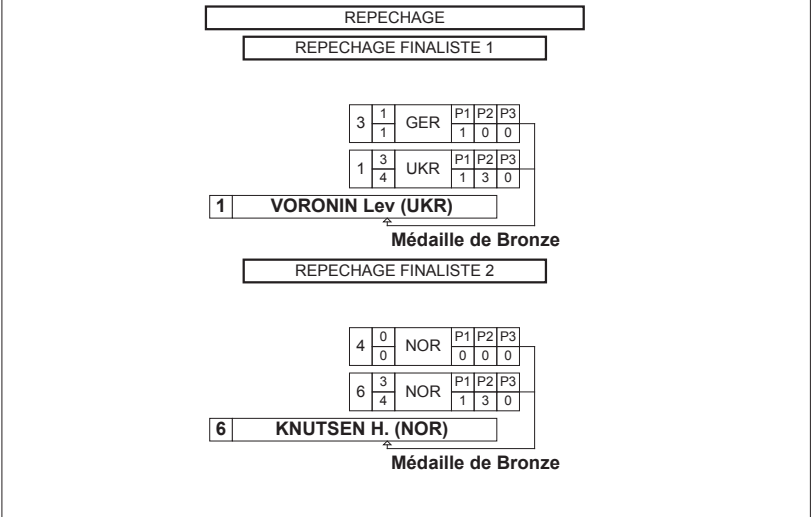



Feuille de compétition / Competition Sheet

Veteran WCH DIV D

STYLE : GR 58 kg



TOUR : 1

1	$\frac{3}{6}$	MAMMADOV Tariyel (AZE)	P1	P2	P3	1	MAMMADOV Tariyel (AZE)
			5	1	0		
2	$\frac{0}{0}$	ILIENKO Victor (RUS)	P1	P2	P3		
			0	0	0		
3	$\frac{3}{4}$	HOVHANNISYAN Zhora (ARM)	P1	P2	P3	3	HOVHANNISYAN Zhora (ARM)
			1	0	3		
4	$\frac{1}{3}$	VIDOV Nikolay (BUL)	P1	P2	P3		
			0	3	0		

TOUR : 2

1	$\frac{3}{3}$	MAMMADOV Tariyel (AZE)	P1	P2	P3	1	MAMMADOV Tariyel (AZE)
			2	1	0		
3	$\frac{0}{0}$	HOVHANNISYAN Zhora (ARM)	P1	P2	P3		
			0	0	0		
2	$\frac{0}{0}$	ILIENKO Victor (RUS)	P1	P2	P3	4	VIDOV Nikolay (BUL)
			0	0	0		
4	$\frac{4}{10}$	VIDOV Nikolay (BUL)	P1	P2	P3		
			6	4	0		

TOUR : 3

1	$\frac{1}{7}$	MAMMADOV Tariyel (AZE)	P1	P2	P3	4	VIDOV Nikolay (BUL)
			6	1	0		
4	$\frac{3}{2}$	VIDOV Nikolay (BUL)	P1	P2	P3		
			0	1	1		
2	$\frac{0}{0}$	ILIENKO Victor (RUS)	P1	P2	P3	3	HOVHANNISYAN Zhora (ARM)
			0	0	0		
3	$\frac{4}{13}$	HOVHANNISYAN Zhora (ARM)	P1	P2	P3		
			7	6	0		

Classement

Cl	Pays	Nom	Points
1	BUL	VIDOV Nikolay	8
2	AZE	MAMMADOV Tariyel	7
3	ARM	HOVHANNISYAN Zhora	7
4	RUS	ILIENKO Victor	0



Feuille de compétition / Competition Sheet

Veteran WCH DIV D

STYLE : GR 63 kg

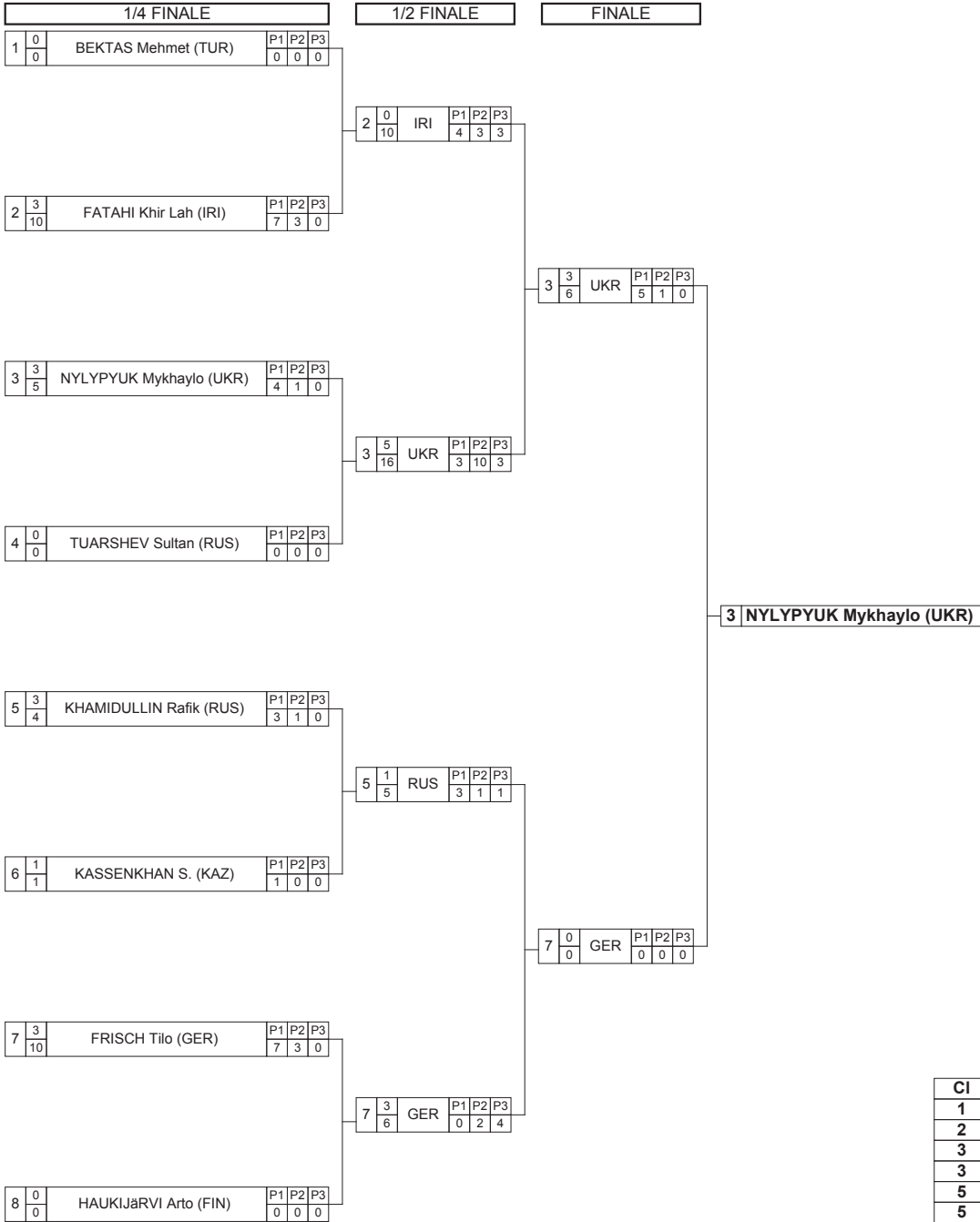
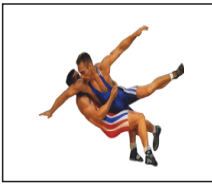

Classement

Cl	Pays	Nom
1	UKR	NYLYPYUK Mykhaylo
2	GER	FRISCH Tilo
3	IRI	FATAHI Khir Lah
3	RUS	KHAMIDULLIN Rafik
5	RUS	TUARSHEV Sultan
5	FIN	HAUKIJärVI Arto
7	KAZ	KASSENKHAN S.
8	TUR	BEKTAS Mehmet

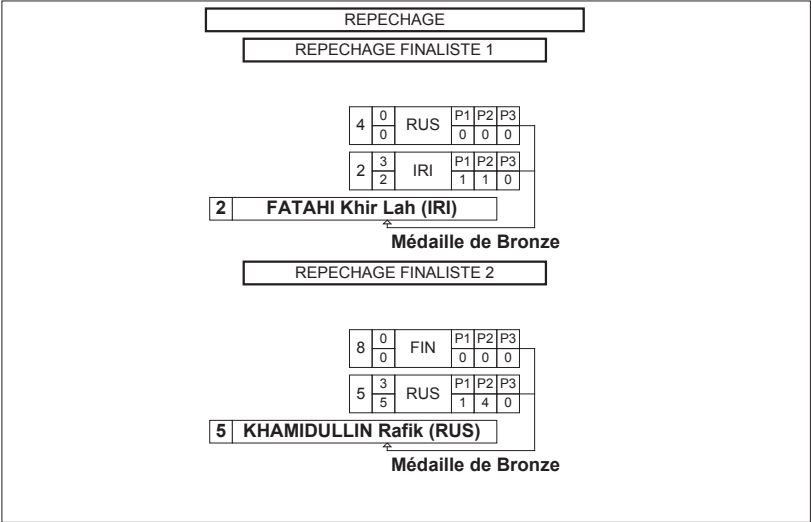



Feuille de compétition / Competition Sheet

Veteran WCH DIV D

STYLE : GR 76 kg

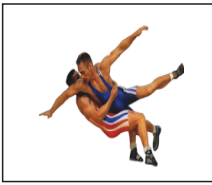

1/4 FINALE

1	3/7	ZSURA János (HUN)	P1	P2	P3
			3	1	3

2	1/8	BROWN Chris (USA)	P1	P2	P3
			7	0	1

3	3/2	SóS István (HUN)	P1	P2	P3
			1	1	0

4	0/0	JOHANSSON Ulf (SWE)	P1	P2	P3
			0	0	0

5	0/0	MÜLLER Rainer (GER)	P1	P2	P3
			0	0	0

6	4/13	ADYRKHAIEV Soslan (UKR)	P1	P2	P3
			6	7	0

7	3/6	ALMASI Hormoz (IRI)	P1	P2	P3
			3	3	0

8	0/0	KORDOS Vadym (UKR)	P1	P2	P3
			0	0	0

1/2 FINALE

1	3/3	HUN	P1	P2	P3
			2	0	1

3	1/4	HUN	P1	P2	P3
			0	3	1

6	3/7	UKR	P1	P2	P3
			6	1	0

7	0/0	IRI	P1	P2	P3
			0	0	0

FINALE

1	1/1	HUN	P1	P2	P3
			0	1	0

6	ADYRKHAIEV Soslan (UKR)
---	-------------------------

6	3/4	UKR	P1	P2	P3
			3	1	0

Classement

Cl	Pays	Nom
1	UKR	ADYRKHAIEV Soslan
2	HUN	ZSURA János
3	USA	BROWN Chris
3	GER	MÜLLER Rainer
5	HUN	SóS István
5	IRI	ALMASI Hormoz
7	SWE	JOHANSSON Ulf
8	UKR	KORDOS Vadym

REPECHAGE

REPECHAGE FINALISTE 1

2	5/5	USA	P1	P2	P3
			0	5	0
3	0/5	HUN	P1	P2	P3
			1	4	0

2	BROWN Chris (USA)
---	-------------------

Médaille de Bronze

REPECHAGE FINALISTE 2

5	3/5	GER	P1	P2	P3
			0	4	1
7	1/3	IRI	P1	P2	P3
			1	2	0

5	MÜLLER Rainer (GER)
---	---------------------

Médaille de Bronze



Feuille de compétition / Competition Sheet

Veteran WCH DIV D

STYLE : GR 85 kg

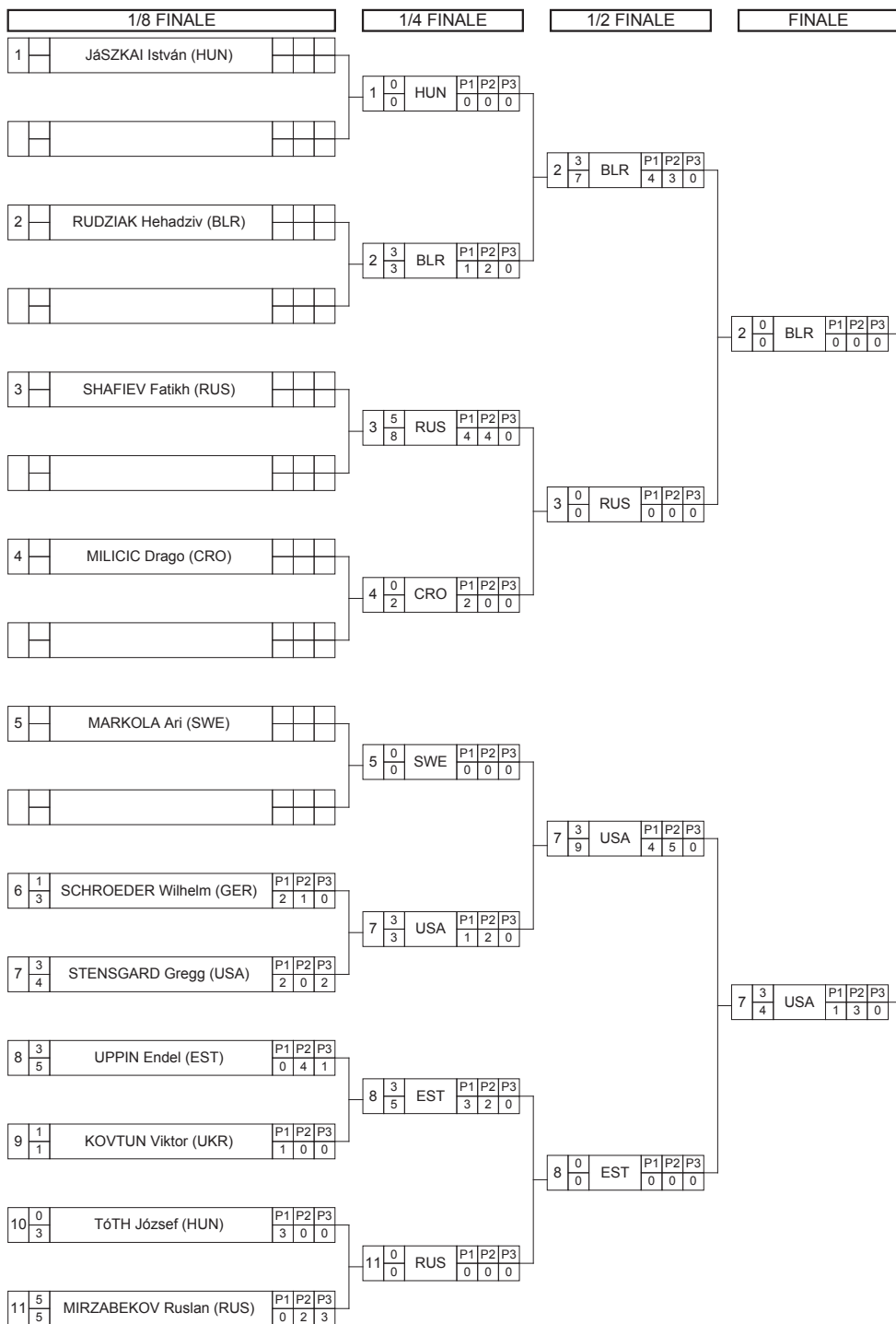

7 STENSGARD Gregg (USA)

Classement

Cl	Pays	Nom
1	USA	STENSGARD Gregg
2	BLR	RUDZIAK Hehadziv
3	HUN	JÁSZKAI István
3	SWE	MARKOLA Ari
5	RUS	SHAFIEV Fatikh
5	EST	UPPIN Endel
7	RUS	MIRZABEKOV Ruslan
8	GER	SCHROEDER Wilhelm
9	UKR	KOVTUN Viktor
10	HUN	TÓTH József
11	CRO	MILICIC Drago

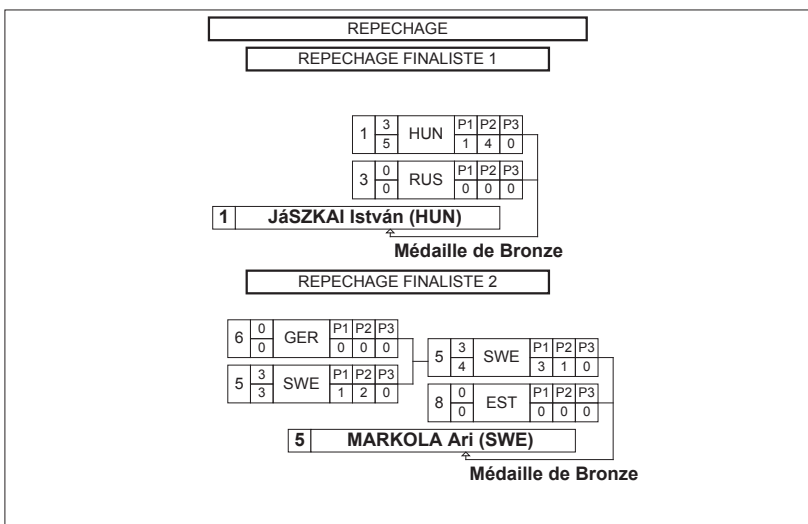



Feuille de compétition / Competition Sheet

Veteran WCH DIV D

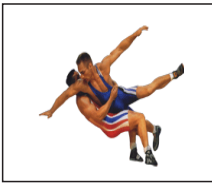

STYLE : GR 97 kg

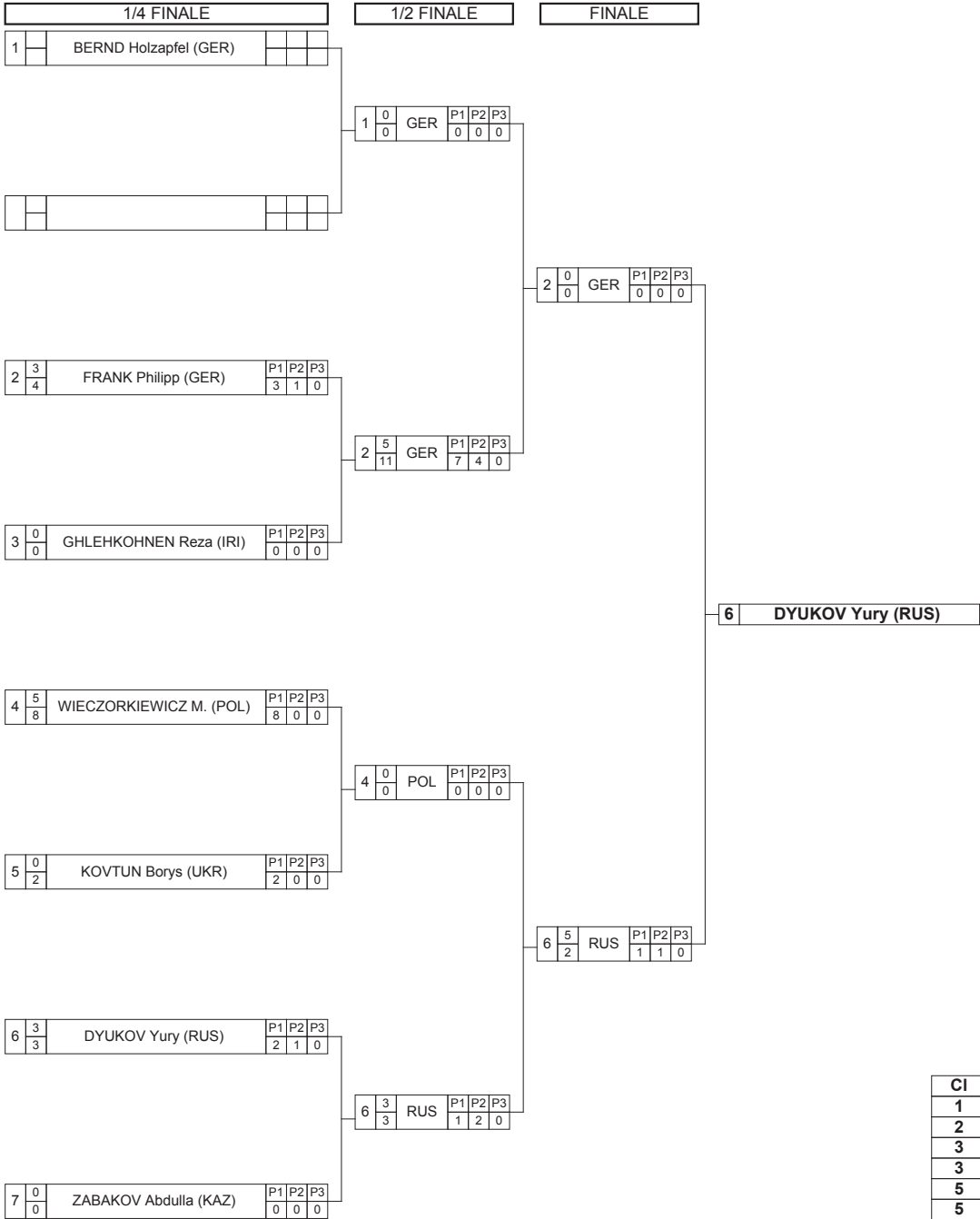

Classement

Cl	Pays	Nom
1	RUS	DYUKOV Yury
2	GER	FRANK Philipp
3	GER	BERND Holzapfel
3	POL	WIECZORKIEWICZ M.
5	IRI	GHLEHKOHNNEN Reza
5	KAZ	ZABAKOV Abdulla
7	UKR	KOVTUN Borys

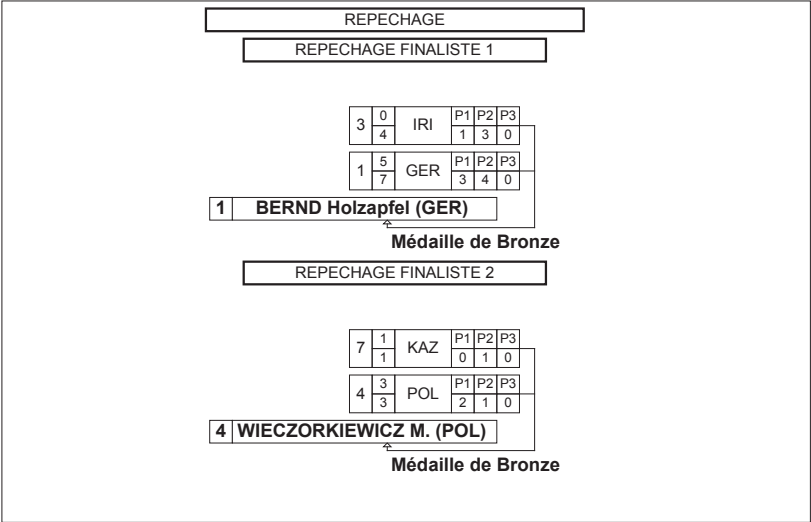



Feuille de compétition / Competition Sheet

Veteran WCH DIV D

STYLE : GR 130 kg

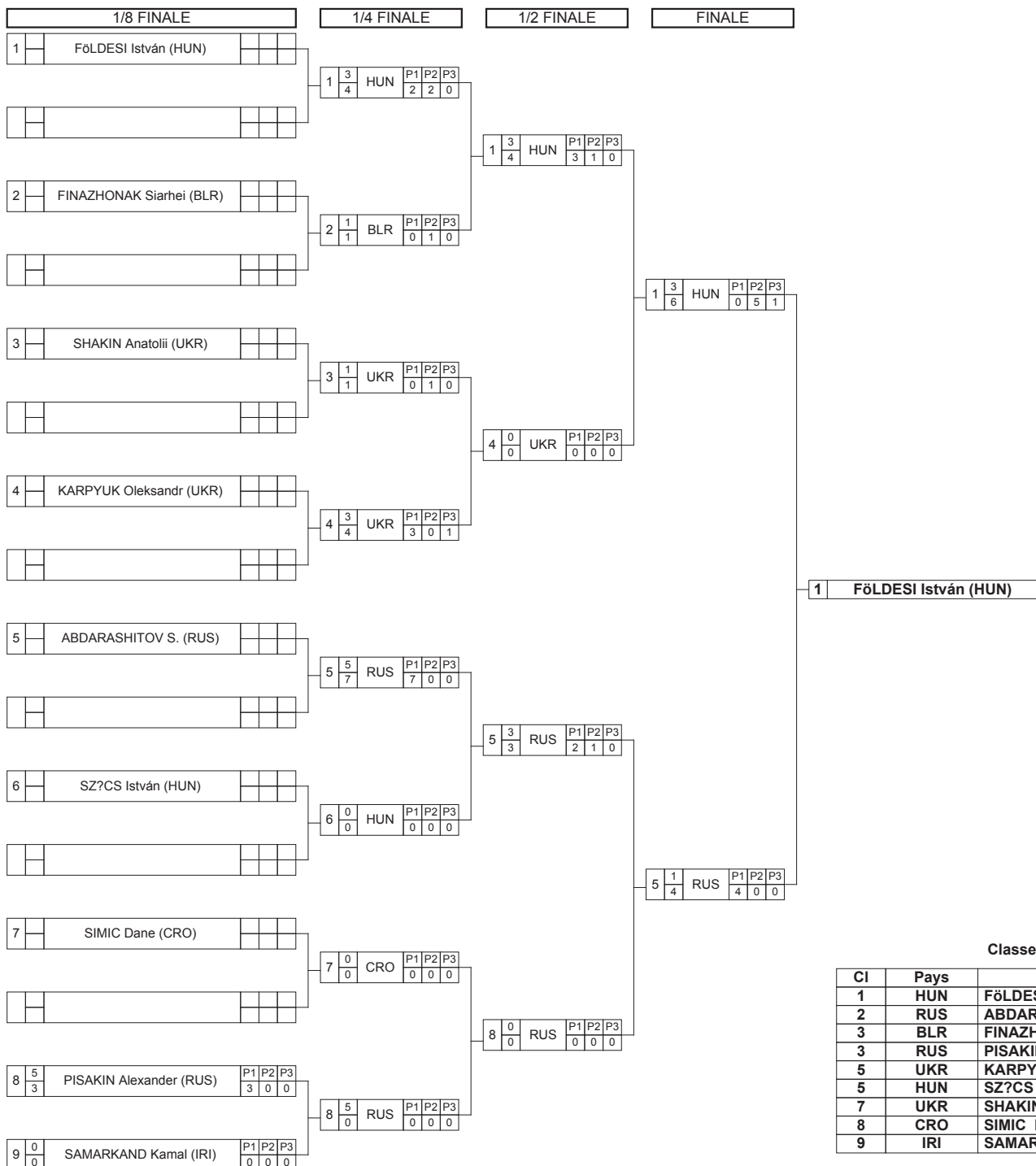

Classement

Cl	Pays	Nom
1	HUN	FÖLDESI István
2	RUS	ABDARASHITOV S.
3	BLR	FINAZHONAK Sjarhei
3	RUS	PISAKIN Alexander
5	UKR	KARPYUK Oleksandr
5	HUN	SZ?CS István
7	UKR	SHAKIN Anatolii
8	CRO	SIMIC Dane
9	IRI	SAMARKAND Kamal

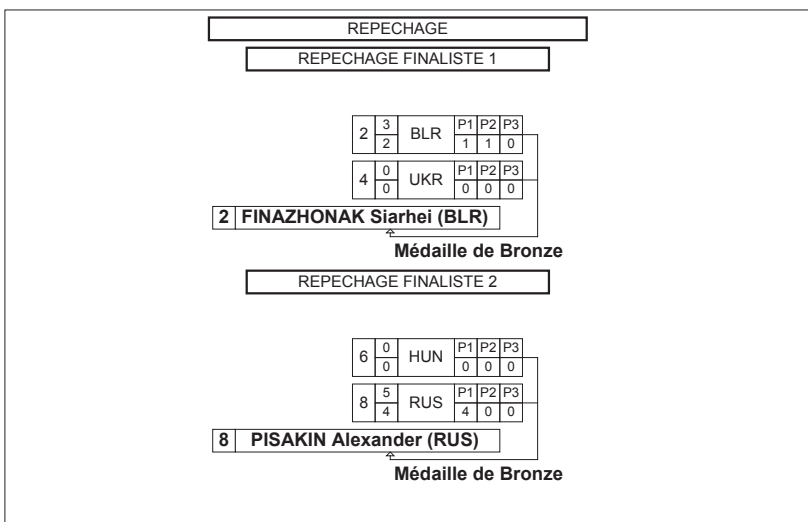



Feuille de compétition / Competition Sheet

Veteran WCH DIV E

STYLE : GR 58 kg



TOUR : 1

1	4 14	YEVGENIY Lim (KAZ)	P1 7	P2 7	P3 0	1	YEVGENIY Lim (KAZ)
2	0 0	LITRA Duro (CRO)	P1 0	P2 0	P3 0		

TOUR : 2

3	1 1	MárTA Mihály (HUN)	P1 0	P2 1	P3 0	1	YEVGENIY Lim (KAZ)
1	3 4	YEVGENIY Lim (KAZ)	P1 1	P2 3	P3 0		

TOUR : 3

2	0 0	LITRA Duro (CRO)	P1 0	P2 0	P3 0	3	MárTA Mihály (HUN)
3	4 12	MárTA Mihály (HUN)	P1 6	P2 6	P3 0		

Classement

Cl	Pays	Nom	Points
1	KAZ	YEVGENIY Lim	7
2	HUN	MárTA Mihály	5
3	CRO	LITRA Duro	0



Feuille de compétition / Competition Sheet

Veteran WCH DIV E

STYLE : GR 63 kg

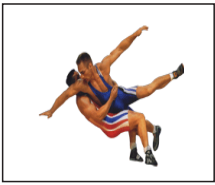

Classement

Cl	Pays	Nom	Points
1	GER	HECKMANN Peter	0



Feuille de compétition / Competition Sheet

Veteran WCH DIV E

STYLE : GR 69 kg



TOUR : 1

1	0 0	MARCHI Daniele (ITA)	P1 0	P2 0	P3 0	2	SHAYDULLIN Ilgiz (RUS)
2	4 5	SHAYDULLIN Ilgiz (RUS)	P1 1	P2 4	P3 0		
3	1 1	ERAK Zvonko (CRO)	P1 0	P2 1	P3 0	4	PEKEC Zdravko (CRO)
4	3 2	PEKEC Zdravko (CRO)	P1 1	P2 0	P3 1		

TOUR : 2

5	3 3	GANZULIC Ivan (CRO)	P1 2	P2 1	P3 0	5	GANZULIC Ivan (CRO)
1	0 0	MARCHI Daniele (ITA)	P1 0	P2 0	P3 0		
2	3 6	SHAYDULLIN Ilgiz (RUS)	P1 3	P2 3	P3 0	2	SHAYDULLIN Ilgiz (RUS)
3	1 2	ERAK Zvonko (CRO)	P1 1	P2 1	P3 0		

TOUR : 3

4	3 6	PEKEC Zdravko (CRO)	P1 3	P2 1	P3 2	4	PEKEC Zdravko (CRO)
1	1 5	MARCHI Daniele (ITA)	P1 5	P2 0	P3 0		
5	1 1	GANZULIC Ivan (CRO)	P1 0	P2 1	P3 0	2	SHAYDULLIN Ilgiz (RUS)
2	3 4	SHAYDULLIN Ilgiz (RUS)	P1 1	P2 3	P3 0		

TOUR : 4

3	4 4	ERAK Zvonko (CRO)	P1 4	P2 0	P3 0	3	ERAK Zvonko (CRO)
1	0 0	MARCHI Daniele (ITA)	P1 0	P2 0	P3 0		
4	3 2	PEKEC Zdravko (CRO)	P1 1	P2 1	P3 0	4	PEKEC Zdravko (CRO)
5	0 0	GANZULIC Ivan (CRO)	P1 0	P2 0	P3 0		

TOUR : 5

2	1 5	SHAYDULLIN Ilgiz (RUS)	P1 2	P2 2	P3 1	4	PEKEC Zdravko (CRO)
4	3 4	PEKEC Zdravko (CRO)	P1 0	P2 2	P3 2		
3	3 5	ERAK Zvonko (CRO)	P1 3	P2 2	P3 0	3	ERAK Zvonko (CRO)
5	0 0	GANZULIC Ivan (CRO)	P1 0	P2 0	P3 0		

Classement

Cl	Pays	Nom	Points
1	CRO	PEKEC Zdravko	12
2	RUS	SHAYDULLIN Ilgiz	11
3	CRO	ERAK Zvonko	9
4	CRO	GANZULIC Ivan	4
5	ITA	MARCHI Daniele	1



Feuille de compétition / Competition Sheet

Veteran WCH DIV E

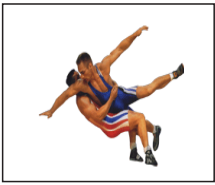

STYLE : GR 76 kg

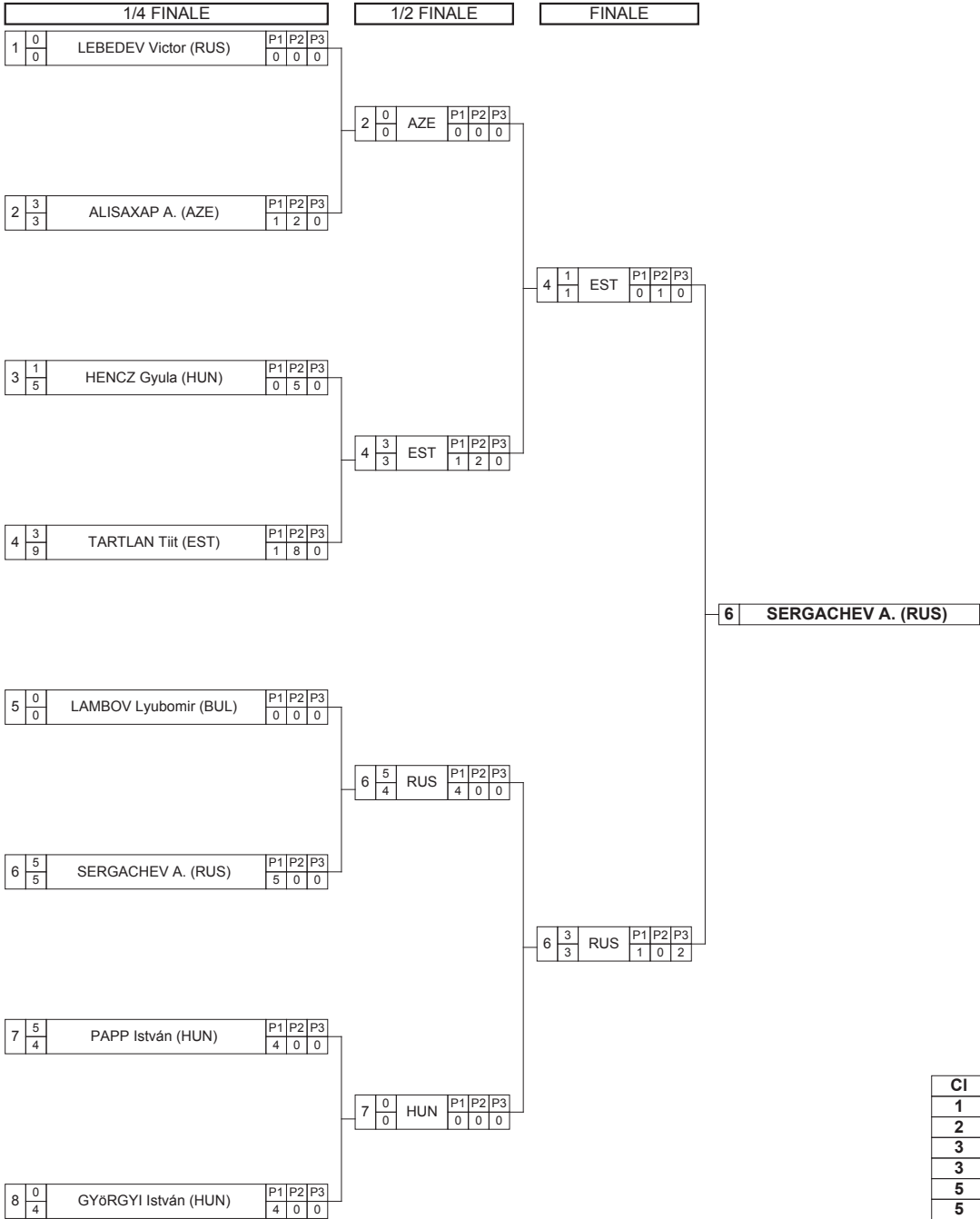

Classement

Cl	Pays	Nom
1	RUS	SERGACHEV Aleksandr
2	EST	TARTLAN Tiit
3	AZE	ALISAXAP Aliabbasov
3	BUL	LAMBOV Lyubomir
5	HUN	HENCZ Gyula
5	HUN	PAPP István
7	HUN	GYÖRGYI István
8	RUS	LEBEDEV Victor

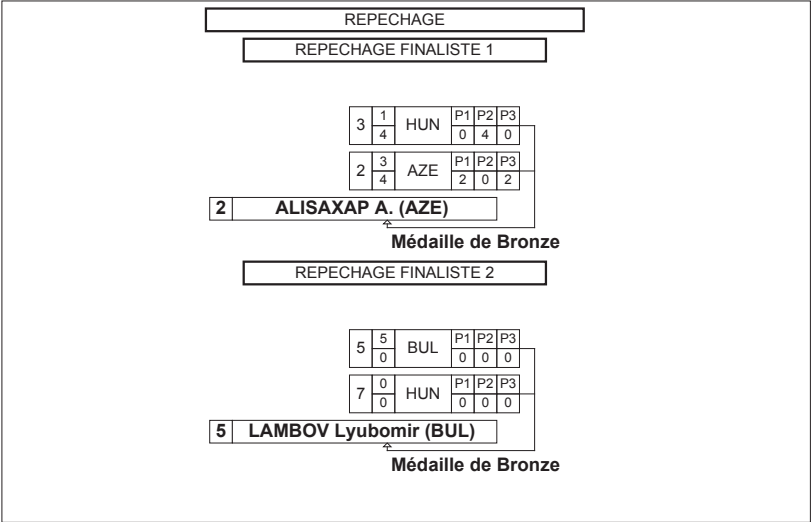



Feuille de compétition / Competition Sheet

Veteran WCH DIV E

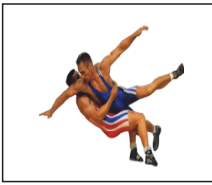

STYLE : GR 85 kg

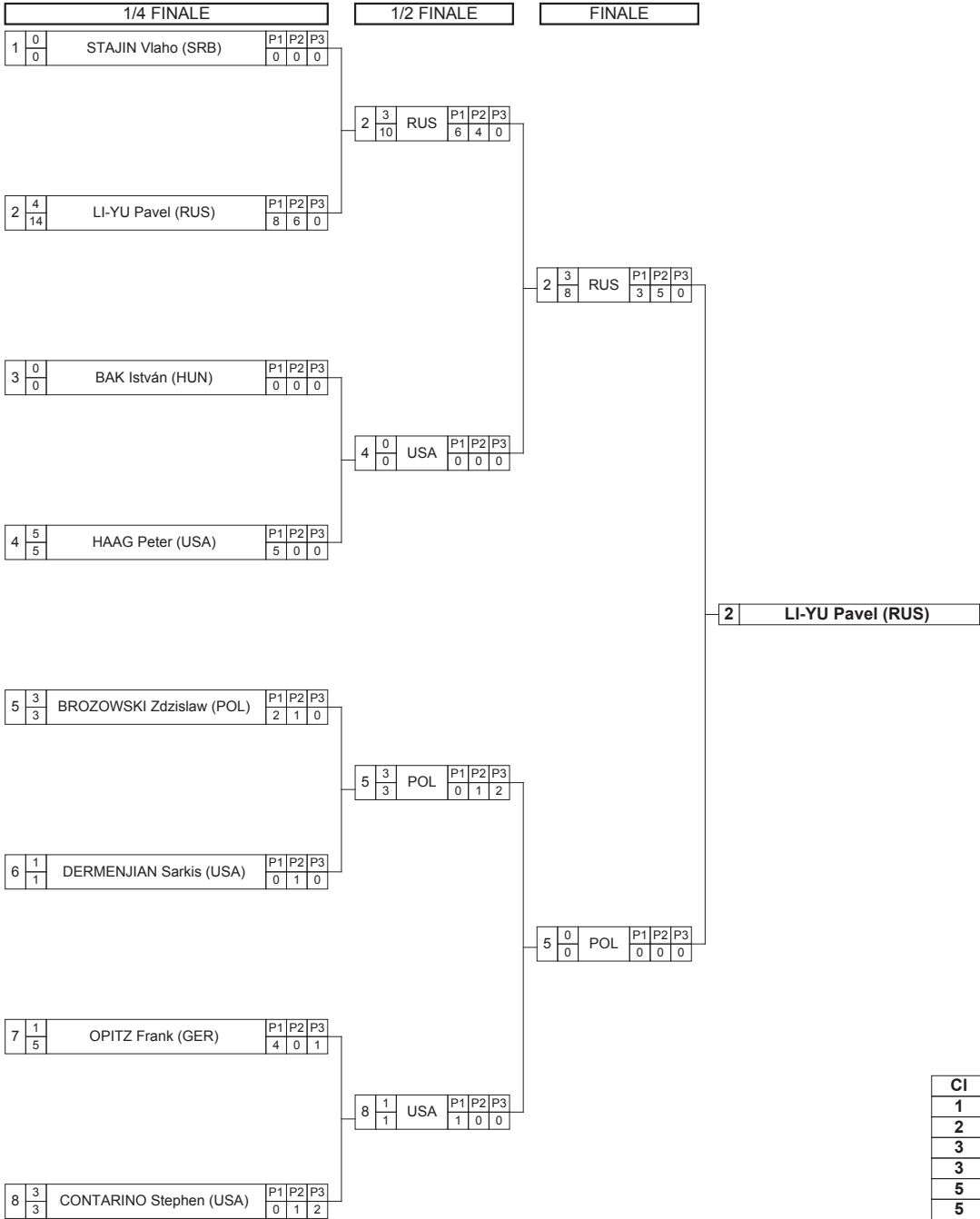

2 LI-YU Pavel (RUS)

Classement

Cl	Pays	Nom
1	RUS	LI-YU Pavel
2	POL	BROZOWSKI Zdzislaw
3	USA	HAAG Peter
3	USA	DERMENJIAN Sarkis
5	SRB	STAJIN Vlaho
5	USA	CONTARINO Stephen
7	GER	OPITZ Frank
8	HUN	BAK István

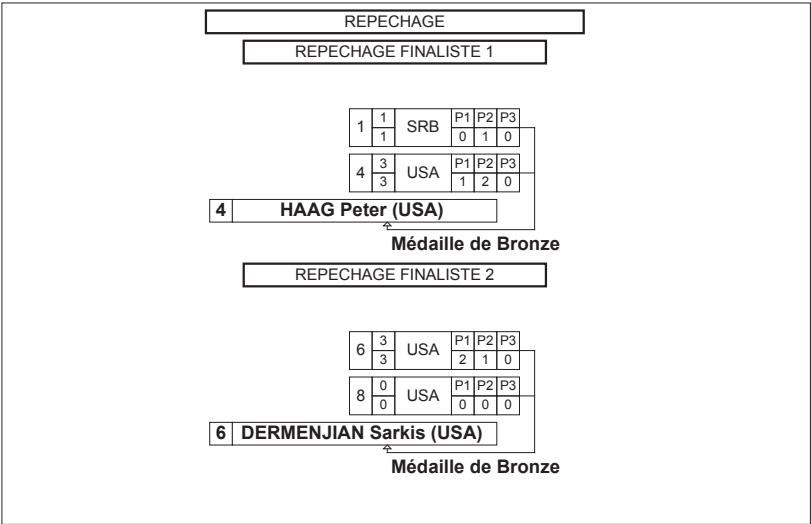



Feuille de compétition / Competition Sheet

Veteran WCH DIV E

STYLE : GR 130 kg



TOUR : 1

1	0 0	BALOGH Ferenc (HUN)	P1 0	P2 0	P3 0	} 2	KAMINSKI Stanislaw (POL)
2	4 3	KAMINSKI Stanislaw (POL)	P1 3	P2 0	P3 0		
3	3 4	GHADERI Jamshid (IRI)	P1 2	P2 1	P3 1	} 3	GHADERI Jamshid (IRI)
4	1 2	NAZHMUDDINOV N. (RUS)	P1 0	P2 2	P3 0		

TOUR : 2

1	1 1	BALOGH Ferenc (HUN)	P1 1	P2 0	P3 0	} 3	GHADERI Jamshid (IRI)
3	3 4	GHADERI Jamshid (IRI)	P1 3	P2 1	P3 0		
2	1 2	KAMINSKI Stanislaw (POL)	P1 2	P2 0	P3 0	} 4	NAZHMUDDINOV N. (RUS)
4	3 11	NAZHMUDDINOV N. (RUS)	P1 6	P2 5	P3 0		

TOUR : 3

1	0 0	BALOGH Ferenc (HUN)	P1 0	P2 0	P3 0	} 4	NAZHMUDDINOV N. (RUS)
4	4 4	NAZHMUDDINOV N. (RUS)	P1 4	P2 0	P3 0		
2	0 0	KAMINSKI Stanislaw (POL)	P1 0	P2 0	P3 0	} 3	GHADERI Jamshid (IRI)
3	3 6	GHADERI Jamshid (IRI)	P1 1	P2 5	P3 0		

Classement

Cl	Pays	Nom	Points
1	IRI	GHADERI Jamshid	9
2	RUS	NAZHMUDDINOV N.	8
3	POL	KAMINSKI Stanislaw	5
4	HUN	BALOGH Ferenc	1



Feuille de compétition / Competition Sheet

Veteran WCH DIV F

STYLE : GR 58 kg



Classement

Cl	Pays	Nom	Points
1	RUS	CHIRKOV Viktor	0



Feuille de compétition / Competition Sheet

Veteran WCH DIV F

STYLE : GR 63 kg

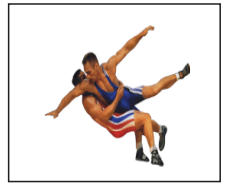

TOUR : 1

1	5	AKOPNIN Mikhail (RUS)	P1	P2	P3	1	AKOPNIN Mikhail (RUS)
	7		7	0	0		
2	0	RONALD L Engel (USA)	P1	P2	P3		
	0		0	0	0		

Classement

Cl	Pays	Nom	Points
1	RUS	AKOPNIN Mikhail	5
2	USA	RONALD L Engel	0



Feuille de compétition / Competition Sheet

Veteran WCH DIV F



STYLE : GR 69 kg

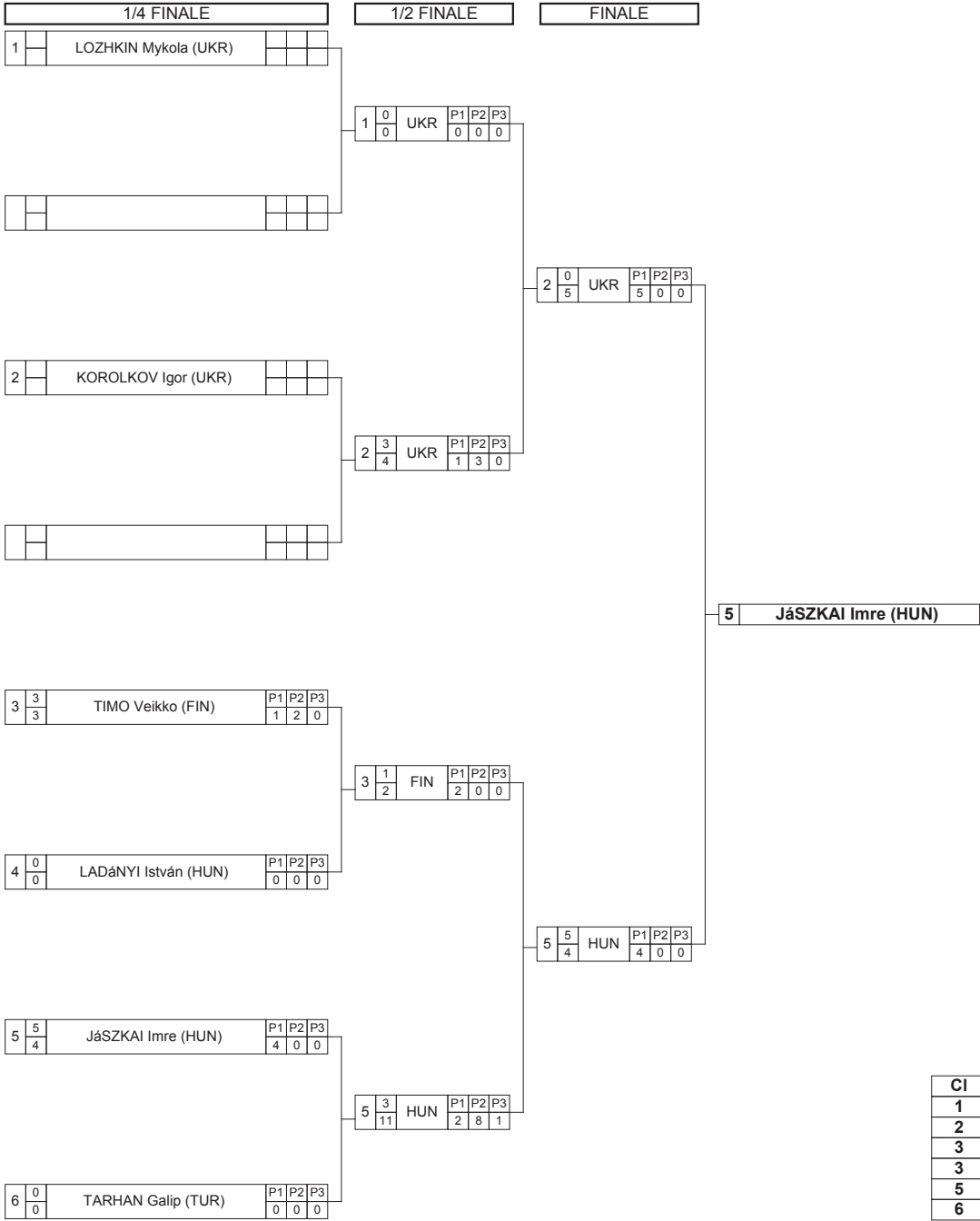

Classement

Cl	Pays	Nom
1	HUN	JÁSZKAI Imre
2	UKR	KOROLKOV Igor
3	UKR	LOZHKIN Mykola
3	FIN	TIMO Veikko
5	TUR	TARHAN Galip
6	HUN	LADÁNYI István

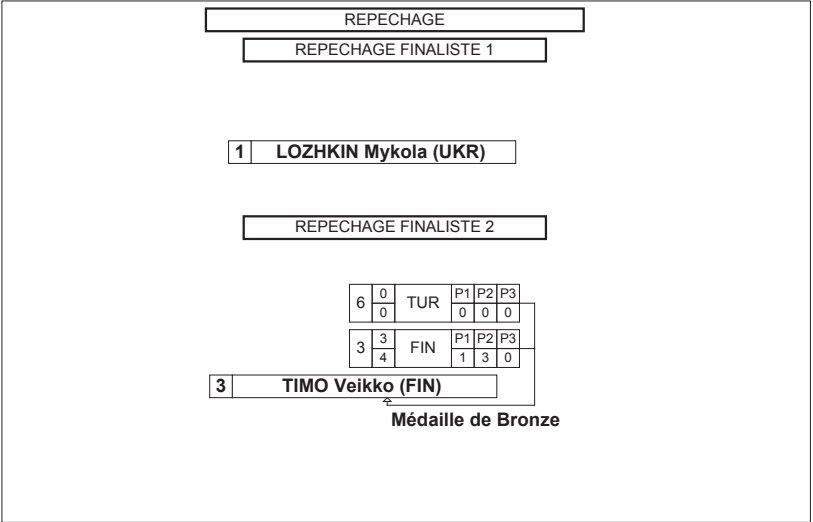



Feuille de compétition / Competition Sheet

Veteran WCH DIV F

STYLE : GR 76 kg



4 KIIREND Olev (EST)

Classement

Cl	Pays	Nom
1	EST	KIIREND Olev
2	HUN	VARGA József
3	LAT	TAUTKUS Henrihs
3	RUS	BUZULIN Konstantin
5	HUN	SZÁVA József
5	GER	HERMANN Nicolai
7	FRA	KOST Jean-Pierre
8	TUR	ÖZGEN Yasar
9	USA	ANCIL Pat

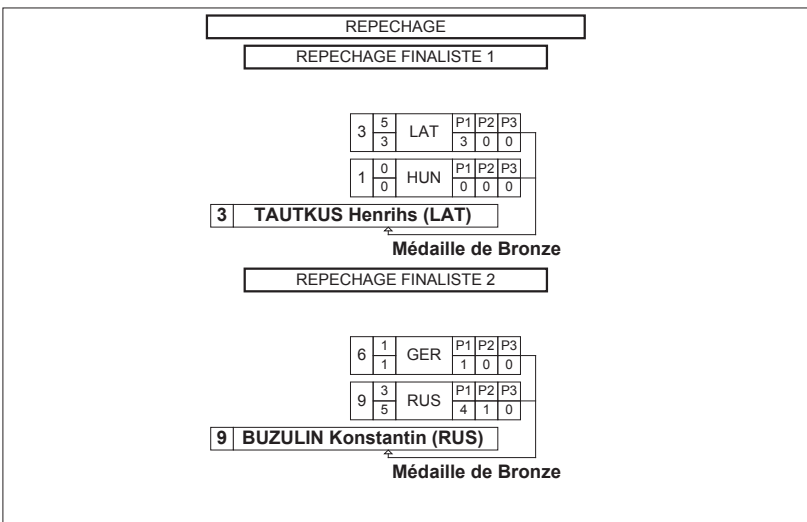



Feuille de compétition / Competition Sheet

Veteran WCH DIV F

STYLE : GR 85 kg



TOUR : 1

1	$\frac{3}{2}$	SAHIN Ahmet (TUR)	P1	P2	P3	1	SAHIN Ahmet (TUR)
			1	1	0		
2	$\frac{0}{0}$	PRICE Gary (USA)	P1	P2	P3		
			0	0	0		
3	$\frac{0}{0}$	SZÁRAZ Ferenc (HUN)	P1	P2	P3	4	TOMILIN Serafim (RUS)
			0	0	0		
4	$\frac{3}{3}$	TOMILIN Serafim (RUS)	P1	P2	P3		
			1	2	0		

TOUR : 2

5	$\frac{4}{5}$	MALTCEV Aleksandr (RUS)	P1	P2	P3	5	MALTCEV Aleksandr (RUS)
			5	0	0		
1	$\frac{0}{0}$	SAHIN Ahmet (TUR)	P1	P2	P3		
			0	0	0		
2	$\frac{0}{0}$	PRICE Gary (USA)	P1	P2	P3	3	SZÁRAZ Ferenc (HUN)
			0	0	0		
3	$\frac{3}{5}$	SZÁRAZ Ferenc (HUN)	P1	P2	P3		
			2	3	0		

TOUR : 3

4	$\frac{4}{4}$	TOMILIN Serafim (RUS)	P1	P2	P3	4	TOMILIN Serafim (RUS)
			4	0	0		
1	$\frac{0}{0}$	SAHIN Ahmet (TUR)	P1	P2	P3		
			0	0	0		
5	$\frac{3}{8}$	MALTCEV Aleksandr (RUS)	P1	P2	P3	5	MALTCEV Aleksandr (RUS)
			6	2	0		
2	$\frac{1}{1}$	PRICE Gary (USA)	P1	P2	P3		
			0	1	0		

TOUR : 4

3	$\frac{4}{4}$	SZÁRAZ Ferenc (HUN)	P1	P2	P3	3	SZÁRAZ Ferenc (HUN)
			3	1	0		
1	$\frac{0}{0}$	SAHIN Ahmet (TUR)	P1	P2	P3		
			0	0	0		
4	$\frac{3}{5}$	TOMILIN Serafim (RUS)	P1	P2	P3	4	TOMILIN Serafim (RUS)
			4	1	0		
5	$\frac{0}{0}$	MALTCEV Aleksandr (RUS)	P1	P2	P3		
			0	0	0		

TOUR : 5

2	$\frac{0}{0}$	PRICE Gary (USA)	P1	P2	P3	4	TOMILIN Serafim (RUS)
			0	0	0		
4	$\frac{4}{4}$	TOMILIN Serafim (RUS)	P1	P2	P3		
			4	0	0		
3	$\frac{0}{0}$	SZÁRAZ Ferenc (HUN)	P1	P2	P3	5	MALTCEV Aleksandr (RUS)
			0	0	0		
5	$\frac{3}{4}$	MALTCEV Aleksandr (RUS)	P1	P2	P3		
			2	2	0		

Classement

Cl	Pays	Nom	Points
1	RUS	TOMILIN Serafim	14
2	RUS	MALTCEV Aleksandr	10
3	HUN	SZÁRAZ Ferenc	7
4	TUR	SAHIN Ahmet	3
5	USA	PRICE Gary	1



Feuille de compétition / Competition Sheet

Veteran WCH DIV F

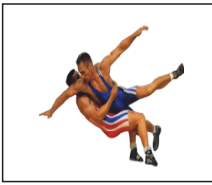

STYLE : GR 97 kg

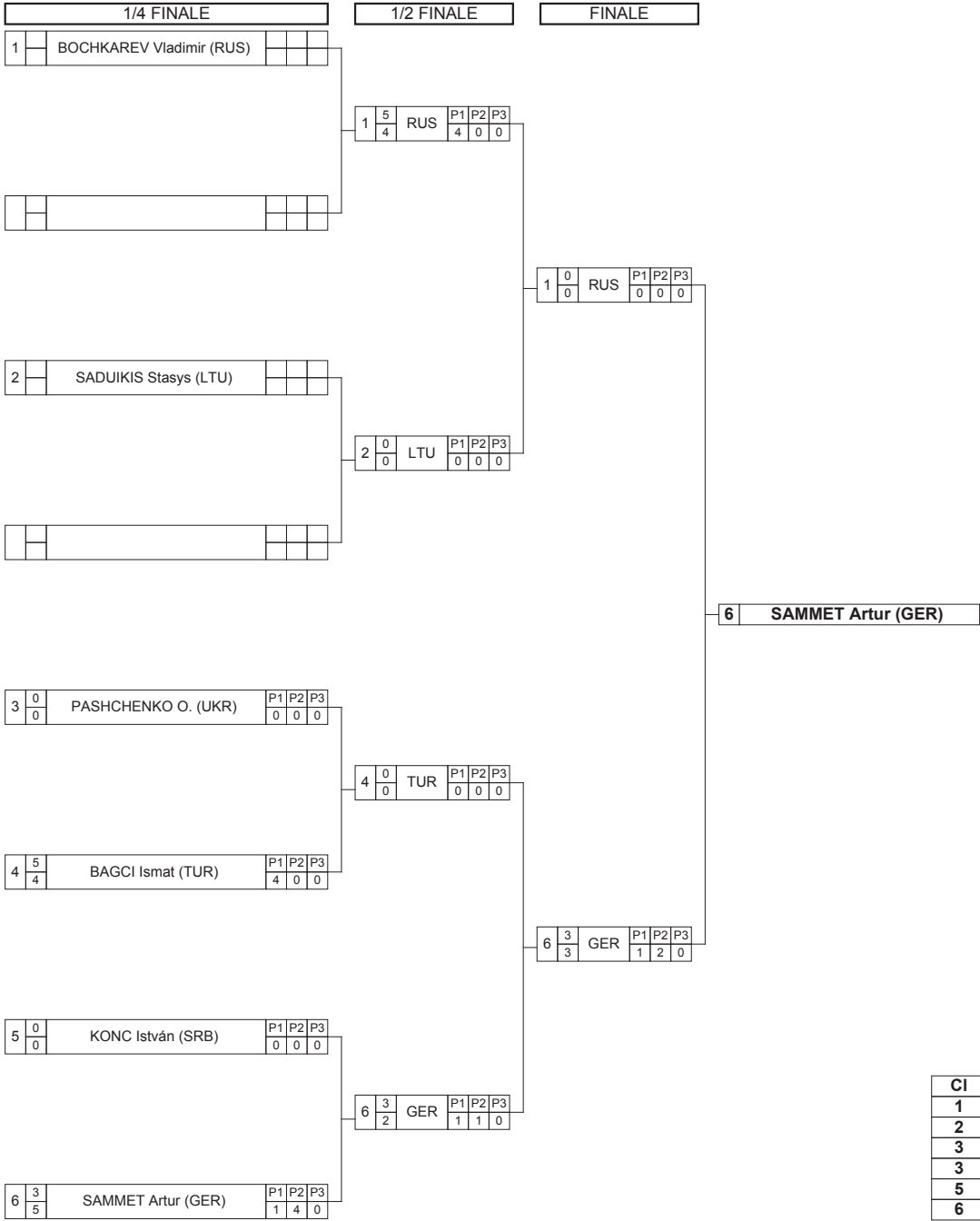

Classement

Cl	Pays	Nom
1	GER	SAMMET Artur
2	RUS	BOCHKAREV Vladimir
3	LTU	SADUIKIS Stasys
3	SRB	KONC István
5	TUR	BAGCI Ismat
6	UKR	PASHCHENKO O.

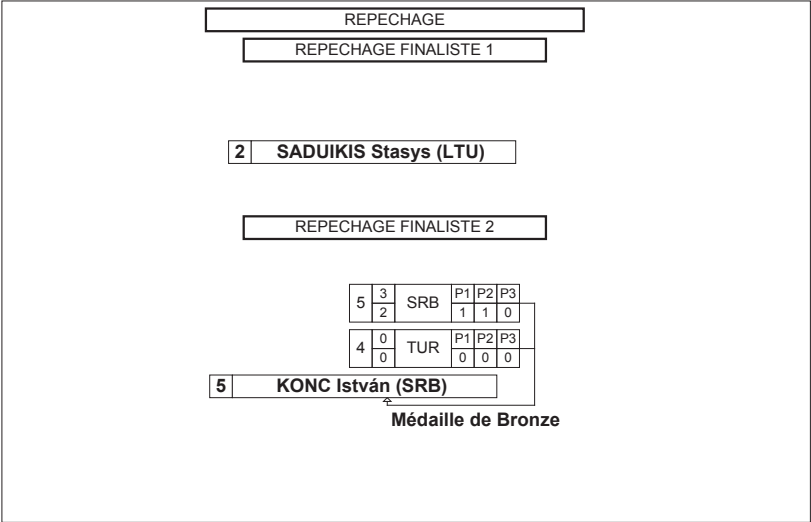



Feuille de compétition / Competition Sheet

Veteran WCH DIV F

STYLE : GR 130 kg



TOUR : 1

1	3	GOGlichidze Estate (GEO)	P1	P2	P3	1	1	0
	2		1	1	0			
2	0	KRASNOV Aleksandr (RUS)	P1	P2	P3	0	0	0
	0		0	0	0			

1 GOGlichidze Estate (GEO)

TOUR : 2

3	1	WAGNER Mihály (HUN)	P1	P2	P3	0	1	0
	1		0	1	0			
1	3	GOGlichidze Estate (GEO)	P1	P2	P3	3	3	0
	6		3	3	0			

1 GOGlichidze Estate (GEO)

TOUR : 3

2	4	KRASNOV Aleksandr (RUS)	P1	P2	P3	4	0	0
	4		4	0	0			
3	0	WAGNER Mihály (HUN)	P1	P2	P3	0	0	0
	0		0	0	0			

2 KRASNOV Aleksandr (RUS)

Classement

Cl	Pays	Nom	Points
1	GEO	GOGlichidze Estate	6
2	RUS	KRASNOV Aleksandr	4
3	HUN	WAGNER Mihály	1



Feuille de compétition / Competition Sheet

Veteran WCH DIV G

STYLE : GR 58 kg



TOUR : 1

1	$\frac{3}{9}$	SZÁRAZ László (HUN)	P1	P2	P3	1	SZÁRAZ László (HUN)
			5	4	0		
2	$\frac{0}{0}$	MELASHVILI Omar (GEO)	P1	P2	P3		
			0	0	0		
3	$\frac{3}{11}$	KORENKOV Aleksandr (RUS)	P1	P2	P3	3	KORENKOV Aleksandr (RUS)
			4	7	0		
4	$\frac{0}{0}$	MUKHARLYAMOV Ildus (RUS)	P1	P2	P3		
			0	0	0		

TOUR : 2

5	$\frac{1}{4}$	STOLARCZYK W. (POL)	P1	P2	P3	1	SZÁRAZ László (HUN)
			3	1	0		
1	$\frac{3}{5}$	SZÁRAZ László (HUN)	P1	P2	P3		
			4	1	0		
2	$\frac{0}{0}$	MELASHVILI Omar (GEO)	P1	P2	P3	3	KORENKOV Aleksandr (RUS)
			0	0	0		
3	$\frac{4}{2}$	KORENKOV Aleksandr (RUS)	P1	P2	P3		
			2	0	0		

TOUR : 3

4	$\frac{4}{7}$	MUKHARLYAMOV Ildus (RUS)	P1	P2	P3	4	MUKHARLYAMOV Ildus (RUS)
			7	0	0		
1	$\frac{0}{0}$	SZÁRAZ László (HUN)	P1	P2	P3		
			0	0	0		
5	$\frac{4}{0}$	STOLARCZYK W. (POL)	P1	P2	P3	5	STOLARCZYK W. (POL)
			0	0	0		
2	$\frac{0}{0}$	MELASHVILI Omar (GEO)	P1	P2	P3		
			0	0	0		

TOUR : 4

3	$\frac{4}{13}$	KORENKOV Aleksandr (RUS)	P1	P2	P3	3	KORENKOV Aleksandr (RUS)
			6	7	0		
1	$\frac{0}{0}$	SZÁRAZ László (HUN)	P1	P2	P3		
			0	0	0		
4	$\frac{3}{5}$	MUKHARLYAMOV Ildus (RUS)	P1	P2	P3	4	MUKHARLYAMOV Ildus (RUS)
			3	2	0		
5	$\frac{0}{0}$	STOLARCZYK W. (POL)	P1	P2	P3		
			0	0	0		

TOUR : 5

2	$\frac{0}{0}$	MELASHVILI Omar (GEO)	P1	P2	P3	4	MUKHARLYAMOV Ildus (RUS)
			0	0	0		
4	$\frac{4}{0}$	MUKHARLYAMOV Ildus (RUS)	P1	P2	P3		
			0	0	0		
3	$\frac{3}{8}$	KORENKOV Aleksandr (RUS)	P1	P2	P3	3	KORENKOV Aleksandr (RUS)
			4	4	0		
5	$\frac{0}{0}$	STOLARCZYK W. (POL)	P1	P2	P3		
			0	0	0		

Classement

Cl	Pays	Nom	Points
1	RUS	KORENKOV Aleksandr	14
2	RUS	MUKHARLYAMOV Ildus	11
3	HUN	SZÁRAZ László	6
4	POL	STOLARCZYK W.	5
5	GEO	MELASHVILI Omar	0



Feuille de compétition / Competition Sheet

Veteran WCH DIV G

STYLE : GR 63 kg



TOUR : 1

1	1	KUTFIDINOV M. (TJK)	P1	P2	P3	2	JUHÁSZ Imre (HUN)
	1		0	1	0		
2	3	JUHÁSZ Imre (HUN)	P1	P2	P3	4	BAUMANN Imre (HUN)
	2		1	0	1		
3	0	ZUBCHENKO V. (UKR)	P1	P2	P3	4	BAUMANN Imre (HUN)
	0		0	0	0		
4	4	BAUMANN Imre (HUN)	P1	P2	P3	4	BAUMANN Imre (HUN)
	7		4	3	0		

TOUR : 2

1	3	KUTFIDINOV M. (TJK)	P1	P2	P3	1	KUTFIDINOV M. (TJK)
	3		1	2	0		
3	0	ZUBCHENKO V. (UKR)	P1	P2	P3	4	BAUMANN Imre (HUN)
	1		1	0	0		
2	0	JUHÁSZ Imre (HUN)	P1	P2	P3	4	BAUMANN Imre (HUN)
	0		0	0	0		
4	4	BAUMANN Imre (HUN)	P1	P2	P3	4	BAUMANN Imre (HUN)
	4		1	3	0		

TOUR : 3

1	0	KUTFIDINOV M. (TJK)	P1	P2	P3	4	BAUMANN Imre (HUN)
	0		0	0	0		
4	3	BAUMANN Imre (HUN)	P1	P2	P3	2	JUHÁSZ Imre (HUN)
	6		5	1	0		
2	4	JUHÁSZ Imre (HUN)	P1	P2	P3	2	JUHÁSZ Imre (HUN)
	0		0	0	0		
3	0	ZUBCHENKO V. (UKR)	P1	P2	P3	0	0
	0		0	0	0		

Classement

Cl	Pays	Nom	Points
1	HUN	BAUMANN Imre	11
2	HUN	JUHÁSZ Imre	7
3	TJK	KUTFIDINOV M.	4
4	UKR	ZUBCHENKO Volodymyr	0



Feuille de compétition / Competition Sheet

Veteran WCH DIV G

STYLE : GR 69 kg



TOUR : 1

1	0 0	PASANEN Jorma (FIN)	P1 0	P2 0	P3 0	} 2 CSATLÓS István (HUN)
2	4 7	CSATLÓS István (HUN)	P1 7	P2 0	P3 0	
3	3 3	CHUCHENKO Mykola (UKR)	P1 2	P2 1	P3 0	} 3 CHUCHENKO Mykola (UKR)
4	0 0	MINAEV Daniel (RUS)	P1 0	P2 0	P3 0	

TOUR : 2

1	0 0	PASANEN Jorma (FIN)	P1 0	P2 0	P3 0	} 3 CHUCHENKO Mykola (UKR)
3	4 3	CHUCHENKO Mykola (UKR)	P1 3	P2 0	P3 0	
2	4 4	CSATLÓS István (HUN)	P1 4	P2 0	P3 0	} 2 CSATLÓS István (HUN)
4	0 0	MINAEV Daniel (RUS)	P1 0	P2 0	P3 0	

TOUR : 3

1	0 7	PASANEN Jorma (FIN)	P1 4	P2 3	P3 0	} 4 MINAEV Daniel (RUS)
4	4 8	MINAEV Daniel (RUS)	P1 2	P2 6	P3 0	
2	0 0	CSATLÓS István (HUN)	P1 0	P2 0	P3 0	} 3 CHUCHENKO Mykola (UKR)
3	4 5	CHUCHENKO Mykola (UKR)	P1 5	P2 0	P3 0	

Classement

Cl	Pays	Nom	Points
1	UKR	CHUCHENKO Mykola	11
2	HUN	CSATLÓS István	8
3	RUS	MINAEV Daniel	4
4	FIN	PASANEN Jorma	0



Feuille de compétition / Competition Sheet

Veteran WCH DIV G

STYLE : GR 76 kg



TOUR : 1

1	3 4	KÓNYA Lajos (HUN)	P1	P2	P3	1	KÓNYA Lajos (HUN)
			1	0	3		
2	1 3	GAPRINDASHVILI S. (GEO)	P1	P2	P3		
			1	2	0		

TOUR : 2

3	4 12	OLUMETS Villi (EST)	P1	P2	P3	3	OLUMETS Villi (EST)
			6	6	0		
1	0 0	KÓNYA Lajos (HUN)	P1	P2	P3		
			0	0	0		

TOUR : 3

2	1 1	GAPRINDASHVILI S. (GEO)	P1	P2	P3	3	OLUMETS Villi (EST)
			1	0	0		
3	3 4	OLUMETS Villi (EST)	P1	P2	P3		
			2	2	0		

Classement

Cl	Pays	Nom	Points
1	EST	OLUMETS Villi	7
2	HUN	KÓNYA Lajos	3
3	GEO	GAPRINDASHVILI S.	2



Feuille de compétition / Competition Sheet

Veteran WCH DIV G

STYLE : GR 85 kg



TOUR : 1

1	$\frac{4}{4}$	EMELIANOV Vladimir (RUS)	P1	P2	P3	1	EMELIANOV Vladimir (RUS)
			4	0	0		
2	$\frac{0}{0}$	SZABÓ János (HUN)	P1	P2	P3		
			0	0	0		
3	$\frac{3}{7}$	DRIZI Veli (ALB)	P1	P2	P3	3	DRIZI Veli (ALB)
			0	6	1		
4	$\frac{1}{1}$	BELYAYEV Borys (UKR)	P1	P2	P3		
			1	0	0		

TOUR : 2

1	$\frac{3}{5}$	EMELIANOV Vladimir (RUS)	P1	P2	P3	1	EMELIANOV Vladimir (RUS)
			3	0	2		
3	$\frac{1}{8}$	DRIZI Veli (ALB)	P1	P2	P3		
			3	4	1		
2	$\frac{4}{5}$	SZABÓ János (HUN)	P1	P2	P3	2	SZABÓ János (HUN)
			5	0	0		
4	$\frac{0}{0}$	BELYAYEV Borys (UKR)	P1	P2	P3		
			0	0	0		

TOUR : 3

1	$\frac{1}{1}$	EMELIANOV Vladimir (RUS)	P1	P2	P3	4	BELYAYEV Borys (UKR)
			1	0	0		
4	$\frac{3}{3}$	BELYAYEV Borys (UKR)	P1	P2	P3		
			0	1	2		
2	$\frac{0}{0}$	SZABÓ János (HUN)	P1	P2	P3	3	DRIZI Veli (ALB)
			0	0	0		
3	$\frac{3}{2}$	DRIZI Veli (ALB)	P1	P2	P3		
			1	1	0		

Classement

Cl	Pays	Nom	Points
1	RUS	EMELIANOV Vladimir	8
2	ALB	DRIZI Veli	7
3	HUN	SZABÓ János	4
4	UKR	BELYAYEV Borys	4



Feuille de compétition / Competition Sheet

Veteran WCH DIV G

STYLE : GR 97 kg

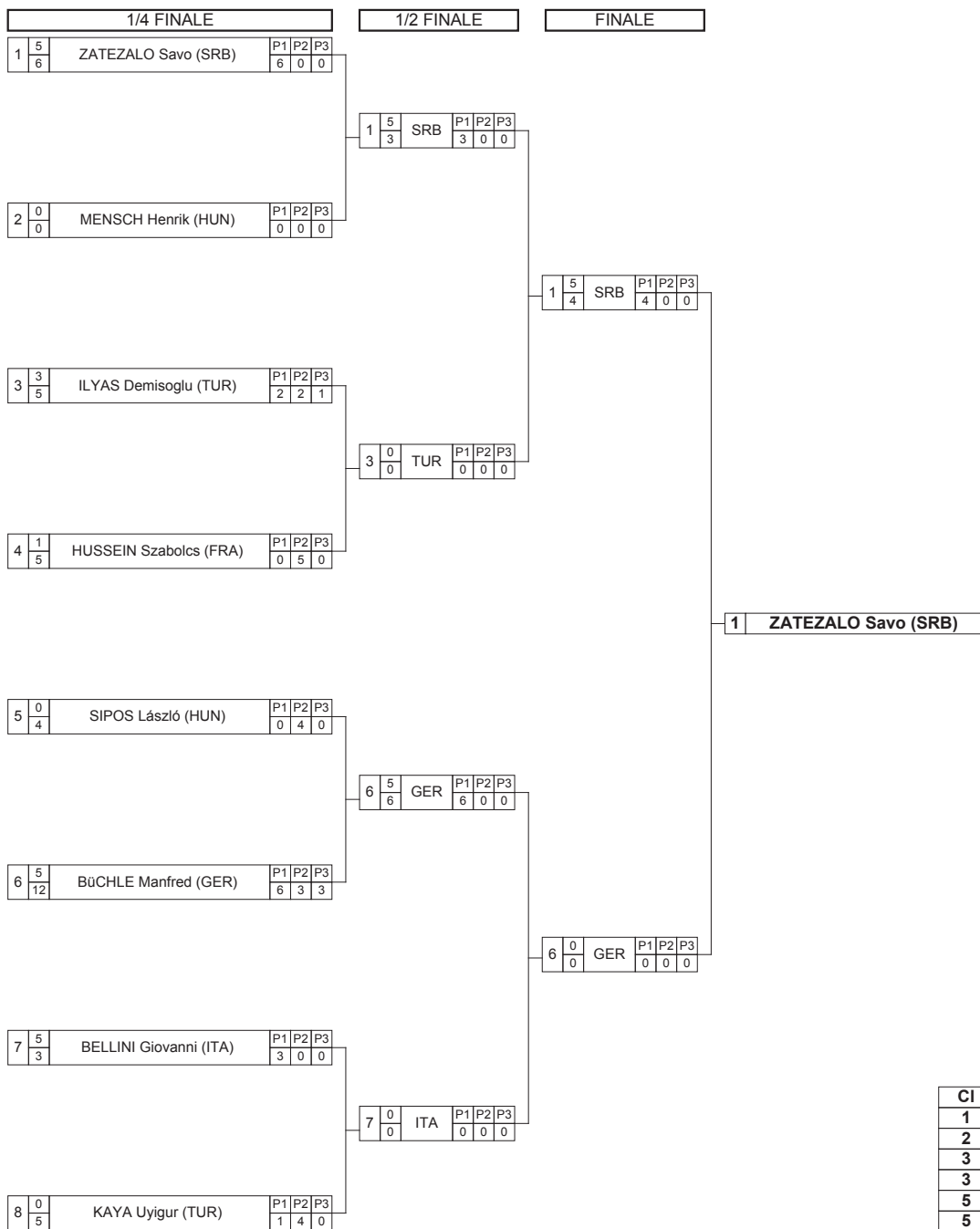

Classement

Cl	Pays	Nom
1	SRB	ZATEZALO Savo
2	GER	BÜCHLE Manfred
3	HUN	MENSCH Henrik
3	HUN	SIPOS László
5	TUR	ILYAS Demisoglu
5	ITA	BELLINI Giovanni
7	FRA	HUSSEIN Szabolcs
8	TUR	KAYA Uyigur

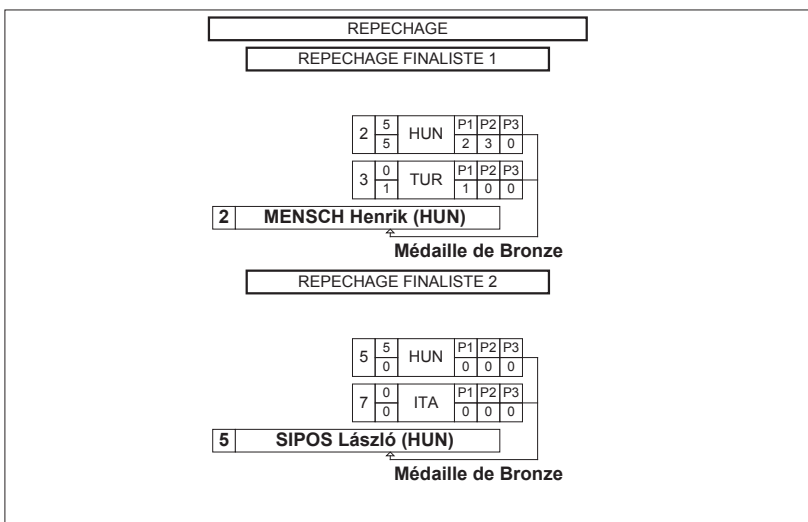



Feuille de compétition / Competition Sheet

Veteran WCH DIV G

STYLE : GR 130 kg



Classement

Cl	Pays	Nom	Points
1	UKR	ANTONCHUK Petro	0