

CHAMPIONNAT DU MONDE - JUNIOR



PATTAYA (THA)

2012

Résultats - Results

Lutte Libre - Free-Style

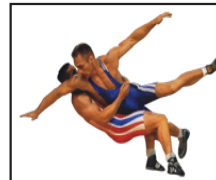
**Liste des arbitres / Referee list****Championnat du Monde - Junior**

N°	Licence	Pays Country	Nom - Last Name	Prénom - First Name
1	4696	BLR	BREL	Ihar
2	3231	TPE	JANG	Tsong-Rong
3	4150	ROU	GYARMATI	Ferenc
4	1455	IND	SINGH	Raj
5	3051	IRI	RAMEZAN NEJAD	Ramezan Ali
6	4112	IRQ	QASSIM	Ali
7	3620	GRE	KANIDIS	Stilianos
8	3419	RUS	KOUCHKHOV	Mulid
9	3286	CHN	PAN	Hongjun
10	2696	AUT	KHALKADAROV	Anatoli
11	3973	UKR	SYTNIK	Vitaliy
12	3318	UZB	BIKTYAKOV	Ravil
13	4212	TKM	GELDIEV	Amangeldi
14	4121	KOR	SEO	Min-Won
15	4387	GER	VOLLMER	Bernd
16	4275	FIN	KUNTTU	Juha
17	4688	CZE	KRENEK	Robin
18	3385	SWE	KAKAVAND	Djalal
19	3348	KGZ	AHMETOV	Meyrambek
20	2829	CRO	OCIC	Zvonko
21	3359	POL	LEBKOWSKI	Karol
22	4278	ROU	OLARU	Marius
23	2648	IRI	EMAMI	Mohammad Ebrahim
24	3850	IRQ	SAIWAN	Ali Mohammed
25	4711	THA	SATJATHAMNUKUL	Pulsak
26	4517	IND	KUMAR	Ashok
27	3767	RUS	ZASEEV	Soltan
28	4421	FRA	MENU-HRISTOV	Céline
29	4173	TUR	SEREN	Ruhi
30	4076	UKR	GILIN	Oleksandr
31	4702	JPN	OKIYAMA	Isao
32	3156	ALG	NAANAA	Yacine
33	4955	CAN	MOHAMMADIAN	Abbas
34	3547	VIE	NGUYEN	Van Duyet
35	3490	IRI	SAHEB	Ardavan
36	3052	IRI	TAHMASEBI	Ali Akbar
37	3422	FRA	DAMIENS	Serge
38	4433	TUR	SEN	Levent
39	4754	EGY	HALAWA	Sherif Ali Ali Ahmed

**Liste des arbitres / Referee list****Championnat du Monde - Junior**

N°	Licence	Pays Country	Nom - Last Name	Prénom - First Name
40	4598	IRQ	HADI HASSAN	Esmaeel
41	4404	USA	BLACKSHEAR	Danny
42	4518	IND	PARSAD	Rajender
43	4508	GRE	LIAKOS	Christos
44	4729	RUS	ARUSTAMYAN	Noravard
45	4701	MGL	GANBOLD	Khadkhuu
46	4689	NOR	HAMMER	Thomas
47	4635	BUL	NEDEV	Stoyko Atanasov
48	3347	AZE	ALIYEV	Garib
49	4416	AUS	PAPADOPOULOS	Larry
50	2818	CYP	LOUKA	Loukas
51	2834	ROU	GUI	Vasile
52	3456	HUN	PÉTERI	László
53	4575	DEN	ZEINEL LÜTFÜ	Atay
54	4489	USA	GOESSL	Casey
55	4438	RUS	BUZIN	Andrei
56	4432	ROU	MREANA	Constantin Cristian
57	3053	IRI	AHMADI	Mirza Agha
58	3694	THA	NOPHARAT	Jarin
59	3430	GRE	PELETIDIS	Trifon
60	4154	FRA	BRAUN	Gilles
61	4049	MGL	BOLORMAA	Luvsan-Ish
62	4045	SVK	MLYNEK	Marek
63	4359	NOR	PEDERSEN	Bjorn Terje
64	4717	JPN	KOIKE	Kuninori
65	3467	KAZ	TAIROV	Yunus
66	4372	JOR	ALMASRI	Khaled Mohammed
67	4382	UAE	AL JUNAIBI	Khaled
68	4748	GEO	JORBENADZE	Malkhaz
69	4584	CAN	DROUGHT	Mike
70	2260	USA	DAVIDSON	Rusty
71		THA	CHOLSTN	Miss Nattha
72	5143	THA	TONGME	Pattana
73	5141	THA	CHAIKATE	Jarong
74	4712	THA	KHAMDEE	Nikom
75	5140	THA	THATSANAPHONPHISAN	Tanavat
76	5144	THA	WICHIEIN	Jirawut

















































Liste des nations / Countries List

Championnat du Monde - Junior

STYLE FS



Pays - Country

	AFRIQUE DU SUD	RSA
	ALGERIA	ALG
	ALLEMAGNE	GER
	ARMENIE	ARM
	AUSTRALIE	AUS
	AUTRICHE	AUT
	AZERBAIJAN	AZE
	BELARUS	BLR
	BULGARIE	BUL
	CANADA	CAN
	CHINE	CHN
	CHINESE TAIPEI	TPE
	COREE	KOR
	EGYPT	EGY
	ESTONIE	EST
	ETATS-UNIS	USA
	FINLANDE	FIN
	GEORGIE	GEO
	GRECE	GRE
	HONGRIE	HUN
	INDIA	IND
	INDONESIA	INA
	IRAN R.I.	IRI
	ISRAEL	ISR
	JAPON	JPN
	KAZAKHSTAN	KAZ
	KYRGYZSTAN	KGZ
	LATVIA	LAT
	MEXICO	MEX
	MOLDAVIE	MDA
	MONGOLIE	MGL
	OUZBEKISTAN	UZB
	POLOGNE	POL
	PUERTO RICO	PUR
	ROUMANIE	ROU
	RUSSIE	RUS
	SINGAPORE	SIN
	SLOVAQUIE	SVK
	SUEDE	SWE
	SUISSE	SUI
	TCHEQUE REP.	CZE
	THAILAND	THA
	TURKMENISTAN	TKM
	TURQUIE	TUR
	UKRAINE	UKR
	VENEZUELA	VEN
	VIETNAM	VIE



Liste des nations / Countries List

Championnat du Monde - Junior

STYLE FS

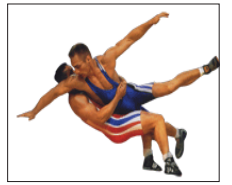

Nombre de nations - Number of Countries

**Nombre d'engagés par nation / Number of Entries By Country****Championnat du Monde - Junior****STYLE FS**

<i>Pays - Country</i>	<i>120 KG</i>	<i>50 KG</i>	<i>55 KG</i>	<i>60 KG</i>	<i>66 KG</i>	<i>74 KG</i>	<i>84 KG</i>	<i>96 KG</i>	<i>TOTAL</i>
ALG					1	1			2
ARM		1	1	1	1	1	1	1	7
AUS			1		1	1	1		4
AUT				1	1				2
AZE	1	1	1	1	1	1	1	1	8
BLR		1	1	1	1	1	1	1	7
BUL	1		1	1	1		1	1	6
CAN	1	1	1	1	1	1	1	1	8
CHN			1	1	1	1			4
CZE						1			1
EGY	1	1	1	1		1	1		6
EST			1						1
FIN				1	1	1			3
GEO	1	1	1	1	1	1	1	1	8
GER	1	1	1		1	1		1	6
GRE	1			1	1	1	1	1	6
HUN		1		1		1	1	1	5
INA				1		1			2
IND	1	1	1	1		1	1	1	7
IRI	1	1	1	1	1	1	1	1	8
ISR			1	1	1	1	1		5
JPN	1	1	1	1	1	1	1	1	8
KAZ	1	1	1	1	1	1	1	1	8
KGZ		1	1	1	1	1	1		6
KOR	1	1	1	1	1	1	1	1	8
LAT						1			1
MDA			1	1		1	1		4
MEX				1					1
MGL	1	1	1	1	1	1	1	1	8
POL						1	1	1	3
PUR						1			1
ROU		1	1	1	1	1			5
RSA				1	1				2

**Nombre d'engagés par nation / Number of Entries By Country****Championnat du Monde - Junior**

STYLE FS

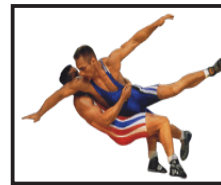

Pays - Country	120 KG	50 KG	55 KG	60 KG	66 KG	74 KG	84 KG	96 KG	TOTAL
RUS	1	1	1	1	1	1	1	1	8
SIN				1					1
SUI					1			1	2
SVK			1				1		2
SWE						1			1
THA			1	1	1	1	1	1	6
TKM			1	1	1	1			4
TPE					1				1
TUR	1	1	1	1	1	1	1	1	8
UKR	1	1	1	1	1	1	1	1	8
USA	1	1	1	1	1	1	1	1	8
UZB		1	1	1	1		1		5
VEN			1	1					2
VIE				1		1			2
TOTAL	17	21	30	35	31	36	27	22	219

Nombre de nations - Number of Countries **47**



Liste des Engagés par pays / Entry-List By Country

Championnat du Monde - Junior

STYLE FS

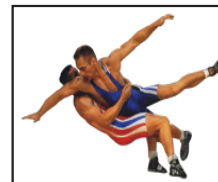

ALGERIA (ALG)

Lutteur(s) / Wrestler(s) :

66 kg	BOUDRAA, Mohammed
74 kg	KACI, Sid Ali

ARMENIA (ARM)

Chef de délégation / Team Leader : ARAQELYAN, Bazmaser
YENOKYAN, Hrant

Entraîneur / Coach : VARDANYAN, Avetik
MALKHASYAN, Armen
KURGHINYAN, Habetnak

Lutteur(s) / Wrestler(s) :

50 kg	ARZUMANYAN, Gevorg
55 kg	HOVHANNISYAN, Artak
60 kg	FRANGULYAN, Valodya
66 kg	APOYAN, Davit
74 kg	GRIGORYAN, Grigor
84 kg	TAMRAZYAN, Vahe
96 kg	KAZISHVILI, Viktor

AUSTRALIA (AUS)

Chef de délégation / Team Leader : LANDY, Alan

Entraîneur / Coach : LANDY, Alan

Lutteur(s) / Wrestler(s) :

55 kg	HOLLAND, Justin Daniel
66 kg	DORNFORD, Jake Conrad
74 kg	LAWRENCE, Jayden Alexander
84 kg	VERREYNNE, Nicolaas Christiaan

AUSTRIA (AUT)

Chef de délégation / Team Leader : AUSSERLEITNER, Max

Entraîneur / Coach : MUTTENTHALER, Wolfgang

Kiné / Medical Staff : SCHWINGER, Julia

Lutteur(s) / Wrestler(s) :

60 kg	AUSSERLEITNER, Maximilian
66 kg	MARCHL, Georg



Liste des Engagés par pays / Entry-List By Country

Championnat du Monde - Junior

STYLE FS

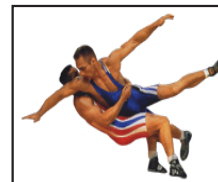

AZERBAIJAN (AZE)

Lutteur(s) / Wrestler(s) :

120 kg	MAGOMEDABIROV, Ali
50 kg	SURKHAYEV, Ruslan
55 kg	ALIYEV, Galib
60 kg	GVARZATILOV, Akhmednabi
66 kg	MAMMADOV, Elchin
74 kg	USUBZADA, Eljan
84 kg	XATIYER, Maganedgadji
96 kg	SHARIPOV, Gadzhi

BELARUS (BLR)

Chef de délégation / Team Leader : YEUDAKIMAVA, Hanna

MALACHENKA, Leanid

Entraîneur / Coach :

YASKULD, Aliaksandr

LASITSA, Aliaksandr

Médecin / Medical Staff :

ZHUKOUSKI, Aliaksandr

Lutteur(s) / Wrestler(s) :

50 kg	KALMYKOU, Artsiom
55 kg	HASANAU, Mahsad
60 kg	PALUEKTAU, Aliaksandr
66 kg	KARPACH, Andrei
74 kg	KAVALIYOU, Uladzimir
84 kg	HUSHTYN, Aliaksandr
96 kg	HARBUNOU, Dzmitry

BULGARIA (BUL)

Entraîneur / Coach : SOFIADI, Rahmat

NEDKOV, Marian

Lutteur(s) / Wrestler(s) :

120 kg	ZAID, Dilyaver Zaid
55 kg	VANGELOV, Georgi Valentinov
60 kg	BOYCHEV, Boycho Hristov
66 kg	SALIM, Oktay Sali
84 kg	SOFIADI, Valentin Rahmat
96 kg	KOLEV, Kaloyan Donev

CANADA (CAN)



Liste des Engagés par pays / Entry-List By Country

Championnat du Monde - Junior

STYLE FS

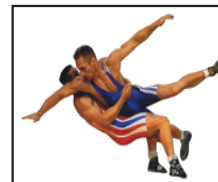

Chef de délégation / Team Leader : JAROSLAWSKI, Larry

Entraîneur / Coach : ABDOU, Justin
ZILBERMAN, Victor

Médecin / Medical Staff : BOYER, Dory

Lutteur(s) / Wrestler(s) :

120 kg	DHINSA, Sunny
50 kg	LEYNES, Patrick
55 kg	TAKAHASHI, Steven Masao
60 kg	ROWE, Nicholas David
66 kg	ABELEV, Ilya
74 kg	WEBB, Dalton James
84 kg	PHULKA, Jasmit Singh
96 kg	OTTO, Riley

CHINA (CHN)

Chef de délégation / Team Leader : PENG, Zhao
LI, Shan
DONG, Shenghui

Entraîneur / Coach : KANG, Xiaowei
ZHOU, Zhanguo

Médecin / Medical Staff : YANG, Chao

Kiné / Medical Staff : BAI, Junbei

Lutteur(s) / Wrestler(s) :

55 kg	NAREN, Manduhu
60 kg	WANG, Jianfeng
66 kg	MU LATI, Muheiyati
74 kg	YAN, Ziling

CZECH REPUBLIC (CZE)

Entraîneur / Coach : ZACEK, Milan

Lutteur(s) / Wrestler(s) :

74 kg	BARVA, Marek
-------	--------------

EGYPT (EGY)

Lutteur(s) / Wrestler(s) :

120 kg	DIAAELDIN, Kamal Gouda
50 kg	RAGAB, Ali Ossama



Liste des Engagés par pays / Entry-List By Country

Championnat du Monde - Junior

STYLE FS



55 kg	FATHY, Mohamed Ashraf
60 kg	MAHMOUD, Ibrahim
74 kg	ZAGHLOUL, Mohamed Aly
84 kg	MOHAMED, Hossam

ESTONIA (EST)

Lutteur(s) / Wrestler(s) :

55 kg	BASKAKOV, Aleksei
-------	-------------------

FINLAND (FIN)

Entraîneur / Coach : RASKA, Ahto

Lutteur(s) / Wrestler(s) :

60 kg	RANNALA, Ronny Martin Tapio
66 kg	MARTIKAINEN, Petteri Johannes
74 kg	KUNNAS, Jere Jaakko

GEORGIA (GEO)

Chef de délégation / Team Leader : KAZARASHVILI, Temo

Entraîneur / Coach : SKHIRELI, Nugzar
LORIA, John
SAGIRASHVILI, Gela

Médecin / Medical Staff : SKHIRELI, Manuchar

Lutteur(s) / Wrestler(s) :

120 kg	PETRIASHVILI, Geno
50 kg	BUJIASHVILI, Beka
55 kg	TALAKHADZE, Lasha
60 kg	BITARASHVILI, Lasha
66 kg	KHABALASHVILI, Konstantine
74 kg	KVELASHVILI, Jumber
84 kg	GOGRICHIANI, Levan
96 kg	MESHVILDISHVILI, Giorgi

GERMANY (GER)

Chef de délégation / Team Leader : SCHERER, Ramona

Entraîneur / Coach : WALTER, Andreas
SCHEIBE, Jürgen

Médecin / Medical Staff : HUBNER, Reinhard



Liste des Engagés par pays / Entry-List By Country

Championnat du Monde - Junior

STYLE FS

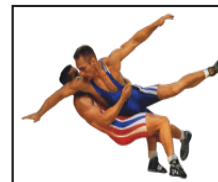

Kiné / Medical Staff :

TRAGESER, Steffen
JENTSCH, Matthias
FRANZ, Axel

Lutteur(s) / Wrestler(s) :

120 kg	SUESS, Franz
50 kg	LUITHLE, Marc
55 kg	WOLFER, Manuel
66 kg	HENKEL, Kevin Christopher
74 kg	DUDAROV, Ahmed Ruslanovic
96 kg	FERDINAND, Robin Michael

GREECE (GRE)

Chef de délégation / Team Leader :

KOLITSOPOULOS, Dimitrios

Entraîneur / Coach :

MOUSTOPOULOS, Nikolaos

Lutteur(s) / Wrestler(s) :

120 kg	SVETLITSKIN, Viktor
60 kg	OVSEPIAN, Antranik
66 kg	SAVVOULIDIS, Georgios
74 kg	AKRITIDIS, Michail
84 kg	XENIDIS, Timofei
96 kg	MOURANTIDIS, Asygekritos

HUNGARY (HUN)

Entraîneur / Coach :

VEREB, Istvan

Lutteur(s) / Wrestler(s) :

50 kg	BENCE, Juhasz
60 kg	MOLNAR, Jozsef
74 kg	GULYAS, Zsombor Istvan
84 kg	GYURITS, Gergely
96 kg	BERDE, Roland

INDIA (IND)

Lutteur(s) / Wrestler(s) :

120 kg	SATYAWART, Kadian
50 kg	PARDEEP, Pardeep
55 kg	YADAV, Baliram Basantl
60 kg	BAJRANG, Bajrang



Liste des Engagés par pays / Entry-List By Country

Championnat du Monde - Junior

STYLE FS

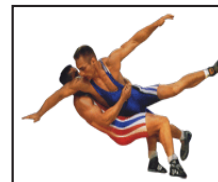

74 kg	DEEPAK, Deepak
84 kg	PAWAN, Kumar
96 kg	SUMEET, Sumeet

INDONESIA (INA)

Lutteur(s) / Wrestler(s) :

60 kg	HAMKA, Hamka
74 kg	AZZHAR, Henry Hidayat

IRAN R.I. (IRI)

Chef de délégation / Team Leader : TABATABAEI, Seyed Moosa
AALI, Parviz

Entraîneur / Coach : AKBARNEJAD, Taghi
GOUDARZI, Saeid
DODANGEH, Aliakbar
HAJIKENARI, Abbas
FARAZMAND, Mehran

Médecin / Medical Staff : SAMADI, Mohammad
TAHERI, Ali

Lutteur(s) / Wrestler(s) :

120 kg	GHOMI AVILI, Abdollah Farzaneh
50 kg	HATAMI, Alireza Ghorban
55 kg	AMOUZADKHALILI, Farzad Mousa
60 kg	EHSANPOOR, Behnam Eshagh
66 kg	JABALI, Aliasghar Rahmatollah
74 kg	ABBASI, Mohsen Mohammad Ali
84 kg	EBRAHIMIZIVLAEI, Mohammadjavad Mohammadebrahim
96 kg	MIRZAEISHAFE, Mehran Behzad

ISRAEL (ISR)

Entraîneur / Coach : SIMONIAN, Sergo

Lutteur(s) / Wrestler(s) :

55 kg	ILIAHU ILIAIEV, David
60 kg	GASANOV, Emrach
66 kg	POPOV, Mark
74 kg	RACHAMIN, Hanoc
84 kg	MYKHALCHENKO, Valentyn David



Liste des Engagés par pays / Entry-List By Country

Championnat du Monde - Junior

STYLE FS

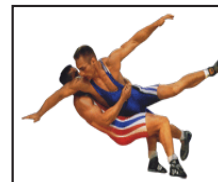

JAPAN (JPN)

Chef de délégation / Team Leader :	ONO, Kyotaro
	SUZUKI, Sakae
Entraîneur / Coach :	OSAWA, Tomohiro
	YOSHIMOTO, Osamu
	TANABE, Chikara
Médecin / Medical Staff :	IMAI, Kazuhiro
Kiné / Medical Staff :	OYAMA, Takahiro
Lutteur(s) / Wrestler(s) :	
120 kg	MURAKAMI, Keiji
50 kg	KAWABATA, Yuya
55 kg	MORISHITA, Fumitaka
60 kg	KAMOI, Masakazu
66 kg	HOSAKA, Ken
74 kg	SHIMADA, Daisuke
84 kg	KAMEYAMA, Akihiro
96 kg	YAMAMOTO, Koki

KAZAKHSTAN (KAZ)

Chef de délégation / Team Leader :	KYSTAUBAYEV, Manar
Entraîneur / Coach :	KYSTAUBAYEV, Manar
	BAIGULOV, Aslan
Médecin / Medical Staff :	TOKHTAGULOV, Zhumash
	CHURIKOVA, Klavdiya
Kiné / Medical Staff :	STARODUBOV, Boris
Lutteur(s) / Wrestler(s) :	
120 kg	SULTANBEK, Bakhtiyar
50 kg	KUDRIN, Vladimir
55 kg	SHAGAPULY, Azamat
60 kg	ASHIROV, Meirzhan
66 kg	ZHOLAYEV, Nurgali
74 kg	AITZHANOV, Saken
84 kg	ABDRASHEV, Yeraly
96 kg	INKAR, Yermukambet

KYRGYZSTAN (KGZ)

Lutteur(s) / Wrestler(s) :	
50 kg	ATYROV, Adilet



Liste des Engagés par pays / Entry-List By Country

Championnat du Monde - Junior

STYLE FS

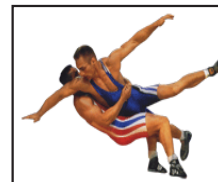

55 kg	DZHUMABEKOV, Abdusomad
60 kg	UMOTBEKOV, Aralbek
66 kg	MAMATOV, Ulukman
74 kg	DOGDURBEK UULU, Elaman
84 kg	UMETALIEV, Adilet

LATVIA (LAT)

Lutteur(s) / Wrestler(s) :

74 kg	RUHLE, Andris Andreas
-------	-----------------------

MEXICO (MEX)

Lutteur(s) / Wrestler(s) :

60 kg	DIAZ, Brandon Disair
-------	----------------------

MOLDOVA (MDA)

Chef de délégation / Team Leader :

SAVVA, Boris
CUCUL, Mihail
MARTA, Petru

Lutteur(s) / Wrestler(s) :

55 kg	DRUCENSCHI, Ion
60 kg	PERPELITA, Maxim
74 kg	LUPU, Sergiu
84 kg	EREMEIV, Evgheni

MONGOLIA (MGL)

Entraîneur / Coach :

TSERENDALAI, Bayarsaikhan
OYUNBILEG, Purevbaatar

Lutteur(s) / Wrestler(s) :

120 kg	ENKHTUGS, Oyunbold
50 kg	BATCHULUUN, Maidar
55 kg	ERDENEBAT, Bekhbayar
60 kg	TUMENBILEG, Tuvshintulga
66 kg	GANTULGA, Iderkhuu
74 kg	BAATAR, Nyambayar
84 kg	BATDORJ, Namkhai
96 kg	DORJKHAND, Khuderbulga



Liste des Engagés par pays / Entry-List By Country

Championnat du Monde - Junior

STYLE FS

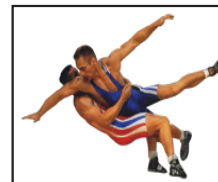

POLAND (POL)

Chef de délégation / Team Leader :	ZOLTOWSKI, Robert
Entraîneur / Coach :	GRZYWINSKI, Dariusz
Kiné / Medical Staff :	NOWAK, Pawel
Lutteur(s) / Wrestler(s) :	
74 kg	MAZUREK, Hubert
84 kg	DUBLINOWSKI, Patryk Mateusz
96 kg	BARAN, Robert

PUERTO RICO (PUR)

Lutteur(s) / Wrestler(s) :	
74 kg	SOLER TANCO, Francisco Daniel

ROMANIA (ROU)

Chef de délégation / Team Leader :	PARCALABU, Razvan
Entraîneur / Coach :	MUMJIEV, Serban
Lutteur(s) / Wrestler(s) :	
50 kg	ERHAN, Octavian
55 kg	DONU, Ioan Raul
60 kg	KATONA, Zsolt
66 kg	MANZALA, Madalin
74 kg	UTA, Remus Sebastian

RUSSIA (RUS)

Chef de délégation / Team Leader :	POPOV, Isay
Entraîneur / Coach :	AZIZOV, Magomed MAGOMEDGADZIEV, Anvarbek LALIEV, Vadim
Médecin / Medical Staff :	GIREEV, Said
Kiné / Medical Staff :	NAZARICHEV, Sergey
Lutteur(s) / Wrestler(s) :	
120 kg	NURASULOV, Magomedgadzhi
50 kg	MAGOMEDALIEV, Magomed
55 kg	MUSUKAEV, Ismail Timurovitch
60 kg	MUZAROV, Zairbeg Aliashabovitch
66 kg	KURBANALIEV, Magomed
74 kg	MAKIEV, Zaur



Liste des Engagés par pays / Entry-List By Country

Championnat du Monde - Junior

STYLE FS

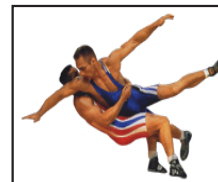

84 kg KUDIYAMAGOMEDOV, Shamil
96 kg NUROV, Magomedgadzhi

SINGAPORE (SIN)

Lutteur(s) / Wrestler(s) :

60 kg TOH, Xin Ran

SLOVAKIA (SVK)

Entraîneur / Coach : JEDLICKA, Miroslav

Lutteur(s) / Wrestler(s) :

55 kg BERDIS, David

84 kg BODNAR, Michael

SOUTH AFRICA (RSA)

Entraîneur / Coach : VAN DER WALT, Cornelius

Lutteur(s) / Wrestler(s) :

60 kg PLAATJIES, Marno Roaun Ronald

66 kg VAN RENSBURG, Terry Killy Jr

SOUTH KOREA (KOR)

Entraîneur / Coach : NOH, Je-Hyoun

Lutteur(s) / Wrestler(s) :

120 kg KIM, Ji-Youn

50 kg PARK, Chang-Jun

55 kg KIM, Guk-Hyeon

60 kg KIM, Chang-Su

66 kg KIM, Do-Ha

74 kg KIM, Hee-Jin

84 kg GWON, Hyeok-Beom

96 kg KIM, Jung Kil

SWEDEN (SWE)

Chef de délégation / Team Leader : BESARATI, Fariborz

YAKOB, Jakob

Entraîneur / Coach : FRELIN, Kim

Lutteur(s) / Wrestler(s) :



Liste des Engagés par pays / Entry-List By Country

Championnat du Monde - Junior

STYLE FS

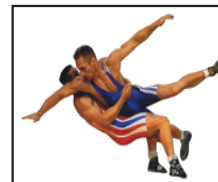

74 kg

STENBERG, Lars Kim

SWITZERLAND (SUI)

Chef de délégation / Team Leader : GISLER, Reto

Entraîneur / Coach : GISLER, Reto

Lutteur(s) / Wrestler(s) :

66 kg REICHMUTH, Stefan

96 kg HUTTER, Philipp marcel

TAIPEI CHINESE (TPE)

Chef de délégation / Team Leader : JANG, Tsong-Rong

Entraîneur / Coach : TUNG, Kuo-Sheng

Lutteur(s) / Wrestler(s) :

66 kg YANG, Nai-Hsuan

THAILAND (THA)

Lutteur(s) / Wrestler(s) :

55 kg KRISTADA, Benmat

60 kg PIPOP, Nampa

66 kg THAWATCHAI, Phatho

74 kg TADSAPOL, Pasawang

84 kg METHEE, Tepakam

96 kg SUMAT, Apairat

TURKEY (TUR)

Entraîneur / Coach : YAVASER, Gokhan

SAGAN, Selahattin

BAYRAM, Amet Atif

AYIK, Nuri

DEMIR, Ramazan

AKTEPE, Elvan

AKKAYA, Mustafa

KIRCI, Gurcan

Médecin / Medical Staff : OZTEMUR, Zekeriya

Kiné / Medical Staff : TURKOGLU, Haydar

YURDUSEVEN, Alev

KISACIK, Tamer



Liste des Engagés par pays / Entry-List By Country

Championnat du Monde - Junior

STYLE FS



Lutteur(s) / Wrestler(s) :

120 kg	OZKARADENIZ, Hamza
50 kg	SANCAK, Muammer
55 kg	CENGIZ, Hakan
60 kg	KILICSALLAYAN, Selahattin
66 kg	KAYA, Mustafa
74 kg	OZMEN, Abdulkadir
84 kg	ERDIN, Fatih
96 kg	BOCEOGLU, Ali

TURKMENISTAN (TKM)

Lutteur(s) / Wrestler(s) :

55 kg	MYRADOV, Saparmyrat
60 kg	HALLYEV, Chary
66 kg	ORAZGYLYJOV, Batyr
74 kg	SHABERDIYEV, Orazberdy

UKRAINE (UKR)

Chef de délégation / Team Leader :

BAZYLIUK, Iaroslav
KAPLUNOVSKIY, Andriy
NOSADCHYY, Eduard

Entraîneur / Coach :

KHARENKO, Dina
SAVCHENKO, Valeriy
NAZARENKO, Yuriy

Médecin / Medical Staff :

MOSKALENKO, Oleksandr
BARSUKOV, Oleksii

Kiné / Medical Staff :

PARNAK, Andriy

Lutteur(s) / Wrestler(s) :

120 kg	KUSHKHOV, Muradyn
50 kg	BLYAZE, Maksym
55 kg	HURSKYY, Vitaliy
60 kg	OGANNESYAN, Gor
66 kg	DZAFARYAN, Rustam
74 kg	IMANOV, Niyaz
84 kg	KNYGIN, Iaroslav
96 kg	VLASOV, Andriy

UNITED STATES (USA)



Liste des Engagés par pays / Entry-List By Country

Championnat du Monde - Junior

STYLE FS

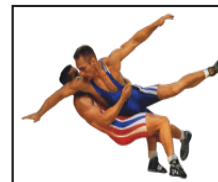

Chef de délégation / Team Leader : ROSBOTTOM, Louis

Entraîneur / Coach : SHELDON, Shawn
ANDERSON, Ike

Médecin / Medical Staff : GROSSMAN, Dave
MONSEAU, AJ

Lutteur(s) / Wrestler(s) :

120 kg	MARSDEN, Austin
50 kg	CORDOVA, Adrian
55 kg	DANCE, Joey
60 kg	HALL, Earl Kincaid
66 kg	MC CAULEY, Desten Gabriel
74 kg	DIERINGER, Alex
84 kg	DOWNEY, Pat
96 kg	HALL, Tanner Mark

UZBEKISTAN (UZB)

Entraîneur / Coach : MUTALOV, Rustam

Lutteur(s) / Wrestler(s) :

50 kg	SHAVKATOV, Makhmudjon
55 kg	GENERALOV, Evgeniy
60 kg	DJURAEV, Mukhamadsidik
66 kg	RIZAEV, Muzaffar
84 kg	ODINAYEV, Shavkatjon

VENEZUELA (VEN)

Lutteur(s) / Wrestler(s) :

55 kg	DAVILA BARON, Andry Jose
60 kg	AGUILAR CANIZALEZ, Ibsen Antonio

VIETNAM (VIE)

Chef de délégation / Team Leader : NGUYEN, The Long

Entraîneur / Coach : TRAN, Van Quang

Lutteur(s) / Wrestler(s) :

60 kg	PHAM, Van Co
74 kg	CAN, Tat Du



Feuille de compétition / Competition Sheet

Championnat du Monde - Junior

STYLE : FS 120 kg

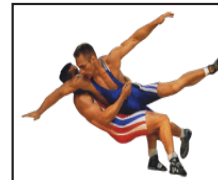

QUALIFICATION		1/8 FINALE	1/4 FINALE	1/2 FINALE	FINALE
1	ENKHTUGS Oyunbold (MGL)	1 1 3 MGL	P1 P2 P3 3 0 0		
2	PETRIASHVILI Geno (GEO)	2 3 12 GEO	P1 P2 P3 6 6 0		
3	DIAAELDIN K. (EGY)	3 3 3 EGY	P1 P2 P3 1 2 0		
4	SATYAWART Kadian (IND)	4 1 1 IND	P1 P2 P3 0 1 0		
5	NURASULOV M. (RUS)	5 3 7 RUS	P1 P2 P3 4 3 0		
6	DHINSA Sunny (CAN)	6 1 2 CAN	P1 P2 P3 2 0 0		
7	MARSDEN Austin (USA)	7 1 4 USA	P1 P2 P3 0 4 0		
8	GHOMI AVILI A. (IRI)	8 3 8 IRI	P1 P2 P3 5 2 1		
9	KUSHKHOV Muradyn (UKR)	9 5 3 UKR	P1 P2 P3 3 0 0		
10	KIM Ji-Youn (KOR)	10 0 0 KOR	P1 P2 P3 0 0 0		
11	MURAKAMI Keiji (JPN)	11 0 0 JPN	P1 P2 P3 0 0 0		
12	MAGOMEDABIROV Ali (AZE)	12 3 8 AZE	P1 P2 P3 1 7 0		
13	ZAID Dilyaver Zaid (BUL)	13 5 3 BUL	P1 P2 P3 3 0 0		
14	SUESS Franz (GER)	14 0 1 GER	P1 P2 P3 1 0 0		
15	SULTANBEK B. (KAZ)	15 3 4 KAZ	P1 P2 P3 1 1 2		
16	OZKARADENIZ Hamza (TUR)	16 3 5 TUR	P1 P2 P3 2 3 0		
17	SVETLITSKIN Viktor (GRE)	17 1 2 GRE	P1 P2 P3 1 1 0		
				2 3 8 GEO	P1 P2 P3 2 6 0
				2 1 6 GEO	P1 P2 P3 4 2 0
				3 0 0 EGY	P1 P2 P3 0 0 0
				5 3 9 RUS	P1 P2 P3 1 6 2
				5 3 7 RUS	P1 P2 P3 4 3 0
				8 1 1 IRI	P1 P2 P3 1 0 0
				9 3 6 UKR	P1 P2 P3 1 5 0
				9 5 5 UKR	P1 P2 P3 5 0 0
				12 0 0 AZE	P1 P2 P3 0 0 0
				13 1 6 BUL	P1 P2 P3 0 3 3
				15 0 0 KAZ	P1 P2 P3 0 0 0
				15 3 11 KAZ	P1 P2 P3 3 2 6
				5 5 4 RUS	P1 P2 P3 4 0 0
				9 0 0 UKR	P1 P2 P3 0 0 0

5 NURASULOV M. (RUS)

Classement

Cl	Pays	Nom
1	RUS	NURASULOV Magomedgadzhi
2	UKR	KUSHKHOV Muradyn
3	GEO	PETRIASHVILI Geno
3	AZE	MAGOMEDABIROV Ali
5	KAZ	SULTANBEK Bakhtiyar
5	CAN	DHINSA Sunny
7	BUL	ZAID Dilyaver Zaid
8	IRI	GHOMI AVILI Abdollah Farzaneh
9	TUR	OZKARADENIZ Hamza
10	EGY	DIAAELDIN Kamal Gouda
11	USA	MARSDEN Austin
12	KOR	KIM Ji-Youn
13	MGL	ENKHTUGS Oyunbold
14	GRE	SVETLITSKIN Viktor
15	IND	SATYAWART Kadian
16	GER	SUESS Franz
17	JPN	MURAKAMI Keiji

REPECHAGE

REPECHAGE FINALISTE 1

6 3 3 CAN	P1 P2 P3 1 0 2	6 1 2 CAN	P1 P2 P3 2 0 0
8 1 1 IRI	P1 P2 P3 0 1 0	2 3 6 GEO	P1 P2 P3 3 3 0

2 PETRIASHVILI Geno (GEO)

Mdaille de Bronze

REPECHAGE FINALISTE 2

10 1 3 KOR	P1 P2 P3 0 3 0	12 3 4 AZE	P1 P2 P3 2 2 0
12 3 5 AZE	P1 P2 P3 2 2 1	15 0 0 KAZ	P1 P2 P3 0 0 0

12 MAGOMEDABIROV Ali (AZE)

Mdaille de Bronze



Classement

Championnat du Monde - Junior

STYLE : FS 120 kg



1 - Or / Gold



NURASULOV Magomedgadzhi

2 - Argent / Silver



KUSHKHOV Muradyn

3 - Bronze



PETRIASHVILI Geno



MAGOMEDABIROV Ali

Classement	Nom - Name	Pays - Country
1	NURASULOV M.	RUS
2	KUSHKHOV Muradyn	UKR
3	PETRIASHVILI Geno	GEO
3	MAGOMEDABIROV Ali	AZE
5	SULTANBEK Bakhtiyar	KAZ
5	DHINSA Sunny	CAN
7	ZAID Dilyaver Zaid	BUL
8	GHOMI AVILI A.	IRI
9	OZKARADENIZ Hamza	TUR
10	DIAAELDIN K.	EGY
11	MARSDEN Austin	USA
12	KIM Ji-Youn	KOR
13	ENKHTUGS Oyunbold	MGL
14	SVETLITSKIN Viktor	GRE
15	SATYAWART Kadian	IND
16	SUESS Franz	GER
17	MURAKAMI Keiji	JPN



Feuille de compétition / Competition Sheet

Championnat du Monde - Junior

STYLE : FS 50 kg



QUALIFICATION		1/8 FINALE		1/4 FINALE		1/2 FINALE		FINALE		
1	SURKHAYEV Ruslan (AZE)	1	3 7	AZE	P1 1	P2 6	P3 0			
2	PARDEEP Pardeep (IND)	2	1 2	IND	P1 0	P2 2	P3 0			
3	LUITHLE Marc (GER)	3	3 10	GER	P1 6	P2 4	P3 0			
4	LEYNES Patrick (CAN)	4	0 1	CAN	P1 0	P2 1	P3 0			
5	SANCAK Muammer (TUR)	5	3 11	TUR	P1 6	P2 5	P3 0			
6	BUJIASHVILI Beka (GEO)	6	1 5	GEO	P1 1	P2 4	P3 0			
7	SHAVKATOV M. (UZB)	7	3 4	UZB	P1 1	P2 2	P3 1			
8	RAGAB Ali Ossama (EGY)	8	1 2	EGY	P1 2	P2 0	P3 0			
9	HATAMI A. (IRI)	9	3 9	IRI	P1 2	P2 7	P3 0			
10	CORDOVA Adrian (USA)	10	1 2	USA	P1 1	P2 1	P3 0			
11	ERHAN Octavian (ROU)	11	3 12	ROU	P1 2	P2 10	P3 0			
12	3 9 KALMYKOU Artsiom (BLR)	P1 1	P2 3	P3 5	12	1 4	BLR	P1 1	P2 3	P3 0
13	1 8 ATYROV Adilet (KGZ)	P1 0	P2 6	P3 2	17	3 10	RUS	P1 6	P2 4	P3 0
14	1 3 KAWABATA Yuya (JPN)	P1 0	P2 3	P3 0	15	1 1	ARM	P1 0	P2 1	P3 0
15	3 13 ARZUMANYAN Gevorg (ARM)	P1 6	P2 7	P3 0	17	3 10	RUS	P1 6	P2 4	P3 0
16	0 1 PARK Chang-Jun (KOR)	P1 0	P2 1	P3 0	17	3 5	RUS	P1 3	P2 2	P3 0
17	5 9 MAGOMEDALIEV M. (RUS)	P1 5	P2 0	P3 4	19	0 9	UKR	P1 7	P2 2	P3 0
18	0 1 BENCE Juhasz (HUN)	P1 1	P2 0	P3 0	21	1 2	MGL	P1 0	P2 2	P3 0
19	5 5 BLYAZE Maksym (UKR)	P1 5	P2 0	P3 0	21	5 8	MGL	P1 0	P2 2	P3 6
20	1 4 KUDRIN Vladimir (KAZ)	P1 2	P2 1	P3 1						
21	3 12 BATCHULUUN Maidar (MGL)	P1 6	P2 0	P3 6						

17 MAGOMEDALIEV M. (RUS)

Classement

Cl	Pays	Nom
1	RUS	MAGOMEDALIEV Magomed
2	AZE	SURKHAYEV Ruslan
3	IND	PARDEEP Pardeep
3	IRI	HATAMI Alireza Ghorban
5	ARM	ARZUMANYAN Gevorg
5	TUR	SANCAK Muammer
7	MGL	BATCHULUUN Maidar
8	UKR	BLYAZE Maksym
9	ROU	ERHAN Octavian
10	BLR	KALMYKOU Artsiom
11	GER	LUITHLE Marc
12	UZB	SHAVKATOV Makhmudjon
13	KGZ	ATYROV Adilet
14	GEO	BUJIASHVILI Beka
15	KAZ	KUDRIN Vladimir
16	JPN	KAWABATA Yuya
17	KOR	PARK Chang-Jun
18	EGY	RAGAB Ali Ossama
19	USA	CORDOVA Adrian
20	HUN	BENCE Juhasz
21	CAN	LEYNES Patrick

REPECHAGE

REPECHAGE FINALISTE 1

2	3 5	IND	P1 1	P2 4	P3 0	2	3 5	IND	P1 1	P2 4	P3 0
3	0 0	GER	P1 0	P2 0	P3 0	5	1 4	TUR	P1 1	P2 3	P3 0

2 PARDEEP Pardeep (IND)

Mdaille de Bronze

REPECHAGE FINALISTE 2

16	1 2	KOR	P1 2	P2 0	P3 0	15	3 7	ARM	P1 0	P2 2	P3 5
15	3 9	ARM	P1 3	P2 6	P3 0	21	1 4	MGL	P1 2	P2 0	P3 2

9 HATAMI A. (IRI)

Mdaille de Bronze



Classement

Championnat du Monde - Junior

STYLE : FS 50 kg



1 - Or / Gold



MAGOMEDALIEV Magomed

2 - Argent / Silver



SURKHAYEV Ruslan

3 - Bronze



PARDEEP Pardeep



HATAMI Alireza Ghorban

Classement	Nom - Name	Pays - Country
1	MAGOMEDALIEV M.	RUS
2	SURKHAYEV Ruslan	AZE
3	PARDEEP Pardeep	IND
3	HATAMI A.	IRI
5	ARZUMANYAN Gevorg	ARM
5	SANCAK Muammer	TUR
7	BATCHULUUN Maidar	MGL
8	BLYAZE Maksym	UKR
9	ERHAN Octavian	ROU
10	KALMYKOU Artsiom	BLR
11	LUITHLE Marc	GER
12	SHAVKATOV M.	UZB
13	ATYROV Adilet	KGZ
14	BUJIASHVILI Beka	GEO
15	KUDRIN Vladimir	KAZ
16	KAWABATA Yuya	JPN
17	PARK Chang-Jun	KOR
18	RAGAB Ali Ossama	EGY
19	CORDOVA Adrian	USA
20	BENCE Juhasz	HUN
21	LEYNES Patrick	CAN



Feuille de compétition / Competition Sheet

Championnat du Monde - Junior

STYLE : FS 55 kg



QUALIFICATION			1/8 FINALE			1/4 FINALE			1/2 FINALE			FINALE		
1	GENERALOV Evgeniy (UZB)		1	1	0	1	1	0	4	3	5	4	0	
2	HOVHANNISYAN Artak (ARM)		2	3	4	2	3	1	2	1	3	0	0	
3	DANCE Joey (USA)	1 0 0	4	3	6	4	3	4	4	3	8	4	0	
4	TALAKHADZE Lasha (GEO)	5 1 0	6	0	2	7	0	4	0	0	0	0	0	
5	MYRADOV Saparmyrat (TKM)	0 0 0	7	3	6	5	1	3	8	3	5	0	0	
6	BASKAKOV Aleksei (EST)	1 2 0	9	0	0	0	0	0	0	0	0	0	0	
7	MORISHITA Fumitaka (JPN)	7 2 0	12	3	10	4	6	0	12	1	4	3	1	
8	VANGELOV G. (BUL)	0 0 0	13	1	1	0	1	0	16	0	0	0	0	
9	BERDIS David (SVK)	4 3 0	16	3	8	3	5	0	17	1	2	0	0	
10	ILIAHU ILIAIEV D. (ISR)	0 0 0	17	1	2	0	2	0	20	0	0	0	0	
11	DZHUMABEKOV A. (KGZ)	0 0 0	20	5	6	2	4	0	20	3	4	3	1	
12	MUSUKAEV I. (RUS)	1 0 0	22	0	2	0	2	0	22	0	2	0	0	
13	DONU Ioan Raul (ROU)	1 4 5	23	3	5	1	4	0	23	3	7	6	1	
14	CENGIZ Hakan (TUR)	1 0 0	26	1	3	0	3	0	26	1	3	0	3	
15	DRUCENSCHI Ion (MDA)	0 0 0	27	0	0	0	0	0	27	0	0	0	0	
16	AMOUZADKHALILI F. (IRI)	3 3 0	30	3	9	3	6	0	30	1	1	1	0	
17	HASANAU Mahsad (BLR)	8 0 0												
18	NAREN Manduhu (CHN)	2 0 0												
19	FATHY M. (EGY)	1 0 0												
20	WOLFER Manuel (GER)	3 6 0												
21	TAKAHASHI S. (CAN)	4 3 2												
22	ALIYEV Galib (AZE)	4 3 8												
23	ERDENEBAT B. (MGL)	2 2 0												
24	HURSKYY Vitaliy (UKR)	1 1 0												
25	DAVILA BARON A. (VEN)	1 1 0												
26	YADAV B. (IND)	0 1 3												
27	KRISTADA Benmat (THA)	3 0 4												
28	HOLLAND J. (AUS)	1 6 1												
29	SHAGAPULY Azamat (KAZ)	0 4 2												
30	KIM Guk-Hyeon (KOR)	1 0 8												

23 ERDENEBAT B. (MGL)

Classement

Cl	Pays	Nom
1	MGL	ERDENEBAT Bekhbayar
2	GEO	TALAKHADZE Lasha
3	JPN	MORISHITA Fumitaka
3	GER	WOLFER Manuel
5	IND	YADAV Baliram Basanti
5	ARM	HOVHANNISYAN Artak
7	RUS	MUSUKAEV Ismail Timurovitch
8	KOR	KIM Guk-Hyeon
9	BLR	HASANAU Mahsad
10	IRI	AMOUZADKHALILI Farzad Mousa
11	USA	DANCE Joey
12	ROU	DONU Ioan Raul
13	AZE	ALIYEV Galib
14	SVK	BERDIS David
15	THA	KRISTADA Benmat
16	EST	BASKAKOV Aleksei
17	UKR	HURSKYY Vitaliy
18	AUS	HOLLAND Justin Daniel
19	CAN	TAKAHASHI Steven Masao
20	KAZ	SHAGAPULY Azamat
21	UZB	GENERALOV Evgeniy
22	VEN	DAVILA BARON Andry Jose
23	EGY	FATHY Mohamed Ashraf
24	TUR	CENGIZ Hakan
25	CHN	NAREN Manduhu
26	KGZ	DZHUMABEKOV Abdusomad
27	TKM	MYRADOV Saparmyrat
28	MDA	DRUCENSCHI Ion
29	ISR	ILIAHU ILIAIEV David
30	BUL	VANGELOV Georgi Valentinov

REPECHAGE

REPECHAGE FINALISTE 1

3	3	11	USA	5	6	0	3	1	7	USA	5	0	2	2	1	4	ARM	4	0	0
6	0	0	EST	0	0	0	2	3	8	ARM	4	1	3	7	3	10	JPN	5	5	0

7 MORISHITA Fumitaka (JPN)

Mdaille de Bronze

REPECHAGE FINALISTE 2

24	1	10	UKR	1	7	2	26	3	7	IND	6	1	0	26	1	2	IND	0	2	0
26	3	8	IND	4	1	3	30	0	0	KOR	0	0	0	20	3	7	GER	4	3	0

20 WOLFER Manuel (GER)

Mdaille de Bronze



Classement

Championnat du Monde - Junior

STYLE : FS 55 kg



1 - Or / Gold



ERDENEBAT Bekhbayar

2 - Argent / Silver



TALAKHADZE Lasha

3 - Bronze



MORISHITA Fumitaka



WOLFER Manuel

Classement	Nom - Name	Pays - Country
1	ERDENEBAT Bekhbayar	MGL
2	TALAKHADZE Lasha	GEO
3	MORISHITA Fumitaka	JPN
3	WOLFER Manuel	GER
5	YADAV B.	IND
5	HOVHANNISYAN Artak	ARM
7	MUSUKAEV I.	RUS
8	KIM Guk-Hyeon	KOR
9	HASANAU Mahsad	BLR
10	AMOUZADKHALILI F.	IRI
11	DANCE Joey	USA
12	DONU Ioan Raul	ROU
13	ALIYEV Galib	AZE
14	BERDIS David	SVK
15	KRISTADA Benmat	THA
16	BASKAKOV Aleksei	EST
17	HURSKYY Vitaliy	UKR
18	HOLLAND J.	AUS
19	TAKAHASHI S.	CAN
20	SHAGAPULY Azamat	KAZ
21	GENERALOV Evgeniy	UZB
22	DAVILA BARON A.	VEN
23	FATHY M.	EGY
24	CENGIZ Hakan	TUR
25	NAREN Manduhu	CHN
26	DZHUMABEKOV A.	KGZ
27	MYRADOV Saparmyrat	TKM
28	DRUCENSCHI Ion	MDA
29	ILIAHU ILIAIEV D.	ISR
30	VANGELOV G.	BUL



Feuille de compétition / Competition Sheet

Championnat du Monde - Junior



STYLE : FS 60 kg

QUALIFICATION				1/16 Finale				1/8 FINALE			
1	3/7	ROWE N. (CAN)	P1 P2 P3 4 3 0	1	3/9	ROWE N. (CAN)	P1 P2 P3 5 4 0	1	3/9	CAN	P1 P2 P3 1 3 5
2	3/7	GASANOV Emrach (ISR)	P1 P2 P3 4 3 0	2	1/1	GASANOV Emrach (ISR)	P1 P2 P3 1 0 0	6	1/1	UZB	P1 P2 P3 1 1 0
3	3/7	PLAATJIES M. (RSA)	P1 P2 P3 4 3 0	3	1/7	PLAATJIES M. (RSA)	P1 P2 P3 5 2 0	4	1/10	ROU	P1 P2 P3 7 0 3
4	3/7	KATONA Zsolt (ROU)	P1 P2 P3 4 3 0	4	3/13	KATONA Zsolt (ROU)	P1 P2 P3 7 6 0	7	3/8	RUS	P1 P2 P3 0 1 7
5	3/7	UMOTBEKOV Aralbek (KGZ)	P1 P2 P3 4 3 0	5	0/0	UMOTBEKOV Aralbek (KGZ)	P1 P2 P3 0 0 0	10	3/9	IND	P1 P2 P3 4 1 0
6	3/7	DJURAEV M. (UZB)	P1 P2 P3 4 3 0	6	3/9	DJURAEV M. (UZB)	P1 P2 P3 5 3 0	11	1/3	VEN	P1 P2 P3 1 2 0
7	3/7	MUZAROV Z. (RUS)	P1 P2 P3 4 3 0	7	3/9	MUZAROV Z. (RUS)	P1 P2 P3 3 6 0	13	1/4	KIM Chang-Su (KOR)	P1 P2 P3 2 2 0
8	3/7	OGANNESYAN Gor (UKR)	P1 P2 P3 4 3 0	8	1/3	OGANNESYAN Gor (UKR)	P1 P2 P3 1 2 0	14	3/5	HALL Earl Kincaid (USA)	P1 P2 P3 2 2 1
9	3/7	OVSEPIAN Antranik (GRE)	P1 P2 P3 4 3 0	9	0/0	OVSEPIAN Antranik (GRE)	P1 P2 P3 0 0 0	15	3/7	AGUILAR CANIZALEZ I. (VEN)	P1 P2 P3 5 2 0
10	3/7	BAJRANG Bajrang (IND)	P1 P2 P3 4 3 0	10	5/8	BAJRANG Bajrang (IND)	P1 P2 P3 2 4 0	16	1/1	USA	P1 P2 P3 0 1 0
11	3/7	AGUILAR CANIZALEZ I. (VEN)	P1 P2 P3 4 3 0	11	3/7	AGUILAR CANIZALEZ I. (VEN)	P1 P2 P3 5 2 0	17	3/15	ARM	P1 P2 P3 7 8 0
12	3/7	RANNALA R. (FIN)	P1 P2 P3 4 3 0	12	1/3	RANNALA R. (FIN)	P1 P2 P3 3 0 0	18	4/13	FRANGULYAN Valodya (ARM)	P1 P2 P3 8 7 0
13	3/7	KIM Chang-Su (KOR)	P1 P2 P3 4 3 0	13	1/4	KIM Chang-Su (KOR)	P1 P2 P3 2 2 0	19	1/1	HALLYEV Chary (TKM)	P1 P2 P3 0 1 0
14	3/7	HALL Earl Kincaid (USA)	P1 P2 P3 4 3 0	14	3/5	HALL Earl Kincaid (USA)	P1 P2 P3 2 2 1	18	3/4	TUMENBILEG T. (MGL)	P1 P2 P3 3 1 0
15	3/7	WANG Jianfeng (CHN)	P1 P2 P3 4 3 0	15	0/0	WANG Jianfeng (CHN)	P1 P2 P3 0 0 0	19	3/8	GVARZATILOV A. (AZE)	P1 P2 P3 5 3 0
16	3/7	FRANGULYAN Valodya (ARM)	P1 P2 P3 4 3 0	16	4/13	FRANGULYAN Valodya (ARM)	P1 P2 P3 8 7 0	20	0/0	MAHMOUD Ibrahim (EGY)	P1 P2 P3 0 0 0
17	3/7	HALLYEV Chary (TKM)	P1 P2 P3 4 3 0	17	1/1	HALLYEV Chary (TKM)	P1 P2 P3 0 1 0	21	3/7	PIPOP Nampa (THA)	P1 P2 P3 4 3 0
18	3/7	TUMENBILEG T. (MGL)	P1 P2 P3 4 3 0	18	3/4	TUMENBILEG T. (MGL)	P1 P2 P3 3 1 0	22	0/0	PIPOP Nampa (THA)	P1 P2 P3 0 0 0
19	3/7	GVARZATILOV A. (AZE)	P1 P2 P3 4 3 0	19	3/8	GVARZATILOV A. (AZE)	P1 P2 P3 5 3 0	22	3/9	BOYCHEV B. (BUL)	P1 P2 P3 6 6 0
20	3/7	MAHMOUD Ibrahim (EGY)	P1 P2 P3 4 3 0	20	0/0	MAHMOUD Ibrahim (EGY)	P1 P2 P3 0 0 0	23	3/9	PHAM Van Co (VIE)	P1 P2 P3 0 4 3
21	3/7	PIPOP Nampa (THA)	P1 P2 P3 4 3 0	21	0/0	PIPOP Nampa (THA)	P1 P2 P3 0 0 0	24	0/0	VIE	P1 P2 P3 0 0 0
22	3/7	BOYCHEV B. (BUL)	P1 P2 P3 4 3 0	22	4/12	BOYCHEV B. (BUL)	P1 P2 P3 6 6 0	25	3/5	EHSANPOOR B. (IRI)	P1 P2 P3 3 2 0
23	3/7	PHAM Van Co (VIE)	P1 P2 P3 4 3 0	23	3/9	PHAM Van Co (VIE)	P1 P2 P3 0 4 3	25	5/9	IRI	P1 P2 P3 5 4 0
24	3/7	PALUEKTAU A. (BLR)	P1 P2 P3 4 3 0	24	1/9	PALUEKTAU A. (BLR)	P1 P2 P3 6 3 0	26	1/2	ASHIROV Meirzhan (KAZ)	P1 P2 P3 2 0 0
25	3/7	EHSANPOOR B. (IRI)	P1 P2 P3 4 3 0	25	3/5	EHSANPOOR B. (IRI)	P1 P2 P3 3 2 0	27	1/2	AUSSERLEITNER M. (AUT)	P1 P2 P3 2 0 0
26	3/7	ASHIROV Meirzhan (KAZ)	P1 P2 P3 4 3 0	26	1/2	ASHIROV Meirzhan (KAZ)	P1 P2 P3 2 0 0	28	0/1	TUR	P1 P2 P3 1 0 0
27	3/7	AUSSERLEITNER M. (AUT)	P1 P2 P3 4 3 0	27	1/2	AUSSERLEITNER M. (AUT)	P1 P2 P3 2 0 0	28	3/8	KILICSALLAYAN S. (TUR)	P1 P2 P3 4 4 0
28	3/7	KILICSALLAYAN S. (TUR)	P1 P2 P3 4 3 0	28	3/8	KILICSALLAYAN S. (TUR)	P1 P2 P3 4 4 0	29	3/11	BITARASHVILI Lasha (GEO)	P1 P2 P3 4 7 0
29	3/7	BITARASHVILI Lasha (GEO)	P1 P2 P3 4 3 0	29	3/11	BITARASHVILI Lasha (GEO)	P1 P2 P3 4 7 0	29	1/2	GEO	P1 P2 P3 2 0 0
30	1/1	MOLNAR Jozsef (HUN)	P1 P2 P3 1 0 0	30	1/1	KAMOI Masakazu (JPN)	P1 P2 P3 1 0 0	33	3/4	PERPELITA Maxim (MDA)	P1 P2 P3 1 3 0
31	3/5	KAMOI Masakazu (JPN)	P1 P2 P3 0 1 4	31	1/1	KAMOI Masakazu (JPN)	P1 P2 P3 1 0 0	33	3/5	MDA	P1 P2 P3 3 2 0
32	0/0	TOH Xin Ran (SIN)	P1 P2 P3 0 0 0	32	3/4	PERPELITA Maxim (MDA)	P1 P2 P3 1 3 0	34	0/0	HAMKA Hamka (INA)	P1 P2 P3 0 0 0
33	5/10	PERPELITA Maxim (MDA)	P1 P2 P3 7 3 0	33	3/4	PERPELITA Maxim (MDA)	P1 P2 P3 1 3 0	35	1/2	DIAZ B. (MEX)	P1 P2 P3 1 1 0
34	0/0	HAMKA Hamka (INA)	P1 P2 P3 0 0 0	34	0/0	DIAZ B. (MEX)	P1 P2 P3 1 1 0				
35	3/3	DIAZ B. (MEX)	P1 P2 P3 2 1 0	35	1/2	DIAZ B. (MEX)	P1 P2 P3 1 1 0				



Feuille de compétition / Competition Sheet

Championnat du Monde - Junior

STYLE : FS 60 kg



Classement

Cl	Pays	Nom
1	IRI	EHSANPOOR Behnam Eshagh
2	RUS	MUZAROV Zairbeg Aliashabovitch
3	KAZ	ASHIROV Meirzhan
3	ARM	FRANGULYAN Valodya
5	AZE	GVARZATILOV Akhmednabi
5	UKR	OGANNESYAN Gor
7	MDA	PERPELITA Maxim
8	IND	BAJRANG Bajrang
9	BUL	BOYCHEV Boycho Hristov
10	CAN	ROWE Nicholas David
11	ROU	KATONA Zsolt
12	GEO	BITARASHVILI Lasha
13	UZB	DJURAEV Mukhamadsidik
14	VEN	AGUILAR CANIZALEZ Ibsen Antonio
15	MGL	TUMENBILEG Tuvshintulga
16	JPN	KAMOI Masakazu
17	USA	HALL Earl Kincaid
18	MEX	DIAZ Brandon Disair
19	TUR	KILICSALLAYAN Selahattin
20	VIE	PHAM Van Co

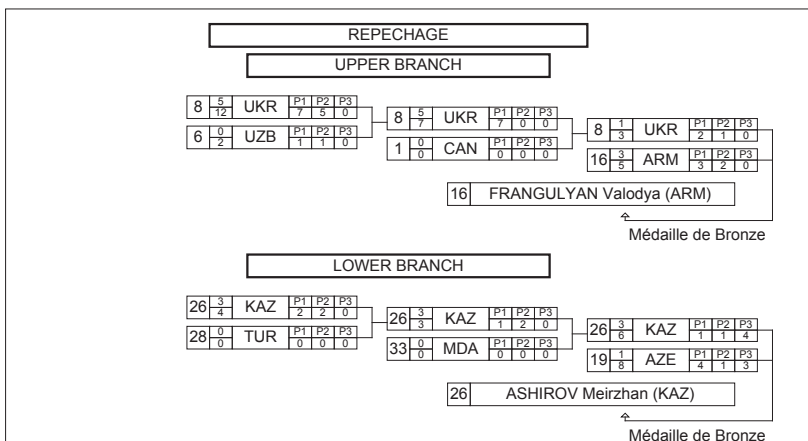



Classement

Championnat du Monde - Junior

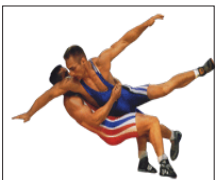

STYLE : FS 60 kg

1 - Or / Gold



EHSANPOOR Behnam Eshagh

2 - Argent / Silver

MUZAROV Zairbeg Aliashabovitch

3 - Bronze



ASHIROV Meirzhan



FRANGULYAN Valodya

Classement	Nom - Name	Pays - Country
1	EHSANPOOR B.	IRI
2	MUZAROV Z.	RUS
3	ASHIROV Meirzhan	KAZ
3	FRANGULYAN Valodya	ARM
5	GVARZATILOV A.	AZE
5	OGANNESYAN Gor	UKR
7	PERPELITA Maxim	MDA
8	BAJRANG Bajrang	IND
9	BOYCHEV B.	BUL
10	ROWE Nicholas David	CAN
11	KATONA Zsolt	ROU
12	BITARASHVILI Lasha	GEO
13	DJURAEV M.	UZB
14	AGUILAR CANIZALEZ I.	VEN
15	TUMENBILEG T.	MGL
16	KAMOI Masakazu	JPN
17	HALL Earl Kincaid	USA
18	DIAZ Brandon Disair	MEX
19	KILICSALLAYAN S.	TUR
20	PHAM Van Co	VIE
21	PALUEKTAU A.	BLR
22	PLAATJIES M.	RSA
23	KIM Chang-Su	KOR
24	RANNALA R.	FIN
25	AUSSERLEITNER M.	AUT
26	HALLYEV Chary	TKM
27	MOLNAR Jozsef	HUN
28	GASANOV Emrach	ISR
29	HAMKA Hamka	INA
30	OVSEPIAN Antranik	GRE



Classement

Championnat du Monde - Junior

STYLE : FS 60 kg

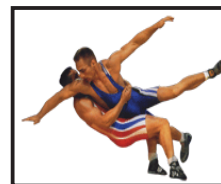

<i>Classement</i>	<i>Nom - Name</i>	<i>Pays - Country</i>
31	MAHMOUD Ibrahim	EGY
32	UMOTBEKOV Aralbek	KGZ
33	TOH Xin Ran	SIN
34	PIPOP Nampa	THA
35	WANG Jianfeng	CHN



Feuille de compétition / Competition Sheet

Championnat du Monde - Junior

STYLE : FS 66 kg



QUALIFICATION				1/8 FINALE				1/4 FINALE				1/2 FINALE				FINALE			
1																			
2	1			1	3	GEO	P1 P2 P3	1	3	GEO	P1 P2 P3	1	3	GEO	P1 P2 P3	1	1	GEO	P1 P2 P3
	8				14		5 9 0		3		1 2 0		10		3 7 0		3		1 2 0
3	3			3	0	AUT	P1 P2 P3	6	0	KGZ	P1 P2 P3	12	1	ARM	P1 P2 P3	24	3	RUS	P1 P2 P3
	13				0		4 9 0		0		0 0 0		2		2 0 0		2		1 0 1
4	3			4	0	FIN	P1 P2 P3	16	1	IRI	P1 P2 P3	23	3	TUR	P1 P2 P3	30	1	GER	P1 P2 P3
	8				0		2 6 0		2		1 1 0		4		0 2 0		2		0 0 0
5	1			5	5	KGZ	P1 P2 P3	19	0	USA	P1 P2 P3	24	3	RUS	P1 P2 P3	31	1	KOR	P1 P2 P3
	2				6		6 6 0		5		5 0 0		5		2 3 0		2		0 1 0
6	4			6	6	KGZ	P1 P2 P3	21	1	KAZ	P1 P2 P3	26	0	JPN	P1 P2 P3				
	12				6		6 6 0		10		6 4 0		0		0 0 0				
7	0			8	3	AZE	P1 P2 P3	23	3	TUR	P1 P2 P3	28	3	GRE	P1 P2 P3				
	0				8		0 0 0		13		0 7 6		4		1 0 3				
8	5			8	8	AZE	P1 P2 P3	23	3	TUR	P1 P2 P3	28	0	GRE	P1 P2 P3				
	6				8		6 0 0		14		1 4 9		0		0 0 0				
9	0			10	1	ROU	P1 P2 P3	23	3	TUR	P1 P2 P3	28	3	GRE	P1 P2 P3				
	0				1		0 0 0		2		0 2 0		4		0 2 4				
10	3			10	1	ROU	P1 P2 P3	23	3	TUR	P1 P2 P3	29	1	MGL	P1 P2 P3				
	10				1		6 4 0		14		0 2 0		6		3 1 2				
11	1			12	3	ARM	P1 P2 P3	23	3	TUR	P1 P2 P3	30	1	UKR	P1 P2 P3				
	4				11		3 1 0		10		6 4 0		1		0 1 0				
12	3			12	3	ARM	P1 P2 P3	23	3	TUR	P1 P2 P3	31	3	KOR	P1 P2 P3				
	7				11		5 2 0		13		0 7 6		2		1 0 1				
13	1			14	0	CAN	P1 P2 P3	16	5	IRI	P1 P2 P3								
	4				2		3 1 0		7		2 2 3								
14	5			14	0	CAN	P1 P2 P3	19	0	USA	P1 P2 P3	21	1	KAZ	P1 P2 P3				
	3				2		0 0 0		5		5 0 0		10		6 4 0				
15	0			16	5	IRI	P1 P2 P3	21	1	KAZ	P1 P2 P3	23	3	TUR	P1 P2 P3				
	0				7		0 0 0		10		6 4 0		13		0 7 6				
16	3			16	7	IRI	P1 P2 P3	21	1	KAZ	P1 P2 P3	23	3	TUR	P1 P2 P3				
	5				7		3 2 0		10		6 4 0		13		0 7 6				
17	0			16	7	IRI	P1 P2 P3	21	1	KAZ	P1 P2 P3	23	3	TUR	P1 P2 P3				
	0				7		0 0 0		10		6 4 0		13		0 7 6				
18	1			16	1	IRI	P1 P2 P3	21	1	KAZ	P1 P2 P3	23	3	TUR	P1 P2 P3				
	1				2		1 1 0		10		6 4 0		13		0 7 6				
19	3			19	0	USA	P1 P2 P3	21	1	KAZ	P1 P2 P3	23	3	TUR	P1 P2 P3				
	4				5		5 0 0		10		6 4 0		13		0 7 6				
20	0			21	1	KAZ	P1 P2 P3	23	3	TUR	P1 P2 P3	23	3	TUR	P1 P2 P3				
	0				10		0 0 0		10		6 4 0		13		0 7 6				
21	3			21	1	KAZ	P1 P2 P3	23	3	TUR	P1 P2 P3	23	3	TUR	P1 P2 P3				
	12				10		5 7 0		10		6 4 0		13		0 7 6				
22	1			23	3	TUR	P1 P2 P3	23	3	TUR	P1 P2 P3	23	3	TUR	P1 P2 P3				
	2				13		0 2 0		13		0 7 6		13		0 7 6				
23	3			23	3	TUR	P1 P2 P3	23	3	TUR	P1 P2 P3	23	3	TUR	P1 P2 P3				
	5				13		2 3 0		13		0 7 6		13		0 7 6				
24	3			24	3	RUS	P1 P2 P3	24	3	RUS	P1 P2 P3	24	3	RUS	P1 P2 P3				
	9				7		3 6 0		9		6 3 0		10		6 4 0				
25	0			24	3	RUS	P1 P2 P3	24	3	RUS	P1 P2 P3	24	3	RUS	P1 P2 P3				
	0				7		0 0 0		9		6 3 0		10		6 4 0				
26	3			26	0	JPN	P1 P2 P3	24	3	RUS	P1 P2 P3	24	3	RUS	P1 P2 P3				
	5				0		1 4 0		9		6 3 0		10		6 4 0				
27	0			26	0	JPN	P1 P2 P3	24	3	RUS	P1 P2 P3	24	3	RUS	P1 P2 P3				
	0				0		0 0 0		9		6 3 0		10		6 4 0				
28	3			28	3	GRE	P1 P2 P3	28	0	GRE	P1 P2 P3	28	0	GRE	P1 P2 P3				
	6				4		0 2 4		0		0 0 0		0		0 0 0				
29	1			28	3	GRE	P1 P2 P3	28	0	GRE	P1 P2 P3	28	0	GRE	P1 P2 P3				
	6				4		3 1 2		0		0 0 0		0		0 0 0				
30	1			31	1	KOR	P1 P2 P3	28	0	GRE	P1 P2 P3	28	0	GRE	P1 P2 P3				
	1				1		0 1 0		0		0 0 0		0		0 0 0				
31	3			31	1	KOR	P1 P2 P3	28	0	GRE	P1 P2 P3	28	0	GRE	P1 P2 P3				
	2				1		1 0 1		0		0 0 0		0		0 0 0				

24 KURBANALIEV M. (RUS)

Classement

Cl	Pays	Nom
1	RUS	KURBANALIEV Magomed
2	GEO	KHALASHVILI Konstantine
3	TUR	KAYA Mustafa
3	ARM	APOYAN Davit
5	AUT	MARCHL Georg
5	GRE	SAVOULIDIS Georgios
7	KGZ	MAMATOV Ulukman
8	AZE	MAMMADOV Elchin
9	IRI	JABALI Aliasghar Rahmatollah
10	BLR	KARPACH Andrei
11	CAN	ABELEV Ilya
12	KAZ	ZHOLAYEV Nurgali
13	ROU	MANZALA Madalin
14	KOR	KIM Do-Ha
15	FIN	MARTIKAINEN Petteri Johannes
16	JPN	HOSAKA Ken
17	USA	MC CAULEY Desten Gabriel
18	CHN	MU LATI Muheiyati
19	MGL	GANTULGA Iderkhuu
20	BUL	SALIM Oktay Sali
21	SUI	REICHMUTH Stefan
22	RSA	VAN RENSBURG Terry Killy Jr
23	ISR	POPOV Mark
24	UKR	DZAFARYAN Rustam
25	UZB	RIZAEV Muzaffar
26	TPE	YANG Nai-Hsuan
27	TKM	ORAZGYLYJOV Batyr
27	ALG	BOUDRAA Mohammed
29	THA	THAWATCHAI Phatho
30	AUS	DORNFORD Jake Conrad
30	GER	HENKEL Kevin Christopher

REPECHAGE

REPECHAGE FINALISTE 1

3	3	AUT	P1 P2 P3	3	1	AUT	P1 P2 P3
	5		1 2 2		1		0 1 0
6	1	KGZ	P1 P2 P3	12	3	ARM	P1 P2 P3
	6		0 4 2		9		6 3 0

12 APOYAN Davit (ARM)

Mdaille de Bronze

REPECHAGE FINALISTE 2

25	5	BLR	P1 P2 P3	25	0	BLR	P1 P2 P3	28	0	GRE	P1 P2 P3
	8		4 4 0		0		0 0 0		2		2 0 0
26	0	JPN	P1 P2 P3	28	4	GRE	P1 P2 P3	23	3	TUR	P1 P2 P3
	5		3 2 0		13		7 6 0		4		2 2 0

23 KAYA Mustafa (TUR)

Mdaille de Bronze



Classement

Championnat du Monde - Junior

STYLE : FS 66 kg



1 - Or / Gold



KURBANALIEV Magomed

2 - Argent / Silver



KHABALASHVILI Konstantine

3 - Bronze



KAYA Mustafa



APOYAN Davit

Classement	Nom - Name	Pays - Country
1	KURBANALIEV Magomed	RUS
2	KHABALASHVILI K.	GEO
3	KAYA Mustafa	TUR
3	APOYAN Davit	ARM
5	MARCHL Georg	AUT
5	SAVVOULIDIS G.	GRE
7	MAMATOV Ulukman	KGZ
8	MAMMADOV Elchin	AZE
9	JABALI A.	IRI
10	KARPACH Andrei	BLR
11	ABELEV Ilya	CAN
12	ZHOLAYEV Nurgali	KAZ
13	MANZALA Madalin	ROU
14	KIM Do-Ha	KOR
15	MARTIKAINEN P.	FIN
16	HOSAKA Ken	JPN
17	MC CAULEY D.	USA
18	MU LATI Muheiyati	CHN
19	GANTULGA Iderkhuu	MGL
20	SALIM Oktay Sali	BUL
21	REICHMUTH Stefan	SUI
22	VAN RENSBURG T.	RSA
23	POPOV Mark	ISR
24	DZAFARYAN Rustam	UKR
25	RIZAEV Muzaffar	UZB
26	YANG Nai-Hsuan	TPE
27	ORAZGYLYJOV Batyr	TKM
27	BOUDRAA Mohammed	ALG
29	THAWATCHAI Phatho	THA
30	DORNFORD J.	AUS



Classement

Championnat du Monde - Junior

STYLE : FS 66 kg



<i>Classement</i>	<i>Nom - Name</i>	<i>Pays - Country</i>
30	HENKEL K.	GER



Feuille de compétition / Competition Sheet

Championnat du Monde - Junior

STYLE : FS 74 kg



QUALIFICATION			1/16 Finale			1/8 FINALE													
1	3/4	KUNNAS Jere Jaakko (FIN)	P1	P2	P3	1	0/0	KUNNAS Jere Jaakko (FIN)	P1	P2	P3	2	3/8	ROU	P1	P2	P3		
	3/4		2	2	0		0/0		0	0	0		1	1	2	5			
2	3/4	UTA R. (ROU)	P1	P2	P3	2	3/4	UTA R. (ROU)	P1	P2	P3	3	1/7	VIE	P1	P2	P3		
	3/4		2	2	0		2	2	0	0	0		0	0	0	0	0		
3	3/4	CAN Tat Du (VIE)	P1	P2	P3	3	3/10	CAN Tat Du (VIE)	P1	P2	P3	6	3/10	AZE	P1	P2	P3		
	3/4		2	2	0		3	7	0		0	6	10	6	4	0			
4	3/4	MAZUREK Hubert (POL)	P1	P2	P3	4	0/0	MAZUREK Hubert (POL)	P1	P2	P3	7	3/9	PUR	P1	P2	P3		
	3/4		2	2	0		0	0	0	0	0		1	4	4				
5	3/4	ABBASI M. (IRI)	P1	P2	P3	5	1/5	ABBASI M. (IRI)	P1	P2	P3	8	3/4	KACI Sid Ali (ALG)	P1	P2	P3		
	3/4		2	2	0		4	0	1		0	1	0	1	0				
6	3/4	USUBZADA Eljan (AZE)	P1	P2	P3	6	3/9	USUBZADA Eljan (AZE)	P1	P2	P3	9	3/5	KVELASHVILI Jumber (GEO)	P1	P2	P3		
	3/4		2	2	0		0	3	6		3	2	0		3	5	0		
7	3/4	SOLER TANCO F. (PUR)	P1	P2	P3	7	3/9	SOLER TANCO F. (PUR)	P1	P2	P3	10	1/1	GULYAS Z. (HUN)	P1	P2	P3		
	3/4		2	2	0		1	4	4		1	0	0		1	0	0		
8	3/4	KACI Sid Ali (ALG)	P1	P2	P3	8	1/4	KACI Sid Ali (ALG)	P1	P2	P3	11	3/9	ZAGHLOUL M. (EGY)	P1	P2	P3		
	3/4		2	2	0		1	0	3		5	4	0		2	3	0		
9	3/4	KVELASHVILI Jumber (GEO)	P1	P2	P3	9	3/5	KVELASHVILI Jumber (GEO)	P1	P2	P3	12	1/2	KIM Hee-Jin (KOR)	P1	P2	P3		
	3/4		2	2	0		3	2	0		2	0	0		2	0	0		
10	3/4	GULYAS Z. (HUN)	P1	P2	P3	10	1/1	GULYAS Z. (HUN)	P1	P2	P3	13	3/3	DUDAROV A. (GER)	P1	P2	P3		
	3/4		2	2	0		1	0	0		0	1	2		5	10	6	4	0
11	3/4	ZAGHLOUL M. (EGY)	P1	P2	P3	11	3/9	ZAGHLOUL M. (EGY)	P1	P2	P3	14	1/1	YAN Ziling (CHN)	P1	P2	P3		
	3/4		2	2	0		5	4	0		1	0	0		1	0	0		
12	3/4	KIM Hee-Jin (KOR)	P1	P2	P3	12	1/2	KIM Hee-Jin (KOR)	P1	P2	P3	15	5/13	RUHLE A. (LAT)	P1	P2	P3		
	3/4		2	2	0		2	0	0		5	8	0		0	0	0		
13	3/4	DUDAROV A. (GER)	P1	P2	P3	13	3/3	DUDAROV A. (GER)	P1	P2	P3	16	0/2	WEBB Dalton James (CAN)	P1	P2	P3		
	3/4		2	2	0		0	1	2		0	2	0		0	0	0		
14	3/4	YAN Ziling (CHN)	P1	P2	P3	14	1/1	YAN Ziling (CHN)	P1	P2	P3	17	3/4	STENBERG Lars Kim (SWE)	P1	P2	P3		
	3/4		2	2	0		1	0	0		2	2	0		2	2	0		
15	3/4	RUHLE A. (LAT)	P1	P2	P3	15	5/13	RUHLE A. (LAT)	P1	P2	P3	18	3/4	GRIGORYAN Grigor (ARM)	P1	P2	P3		
	3/4		2	2	0		5	8	0		0	1	0		0	1	0		
16	3/4	WEBB Dalton James (CAN)	P1	P2	P3	16	0/2	WEBB Dalton James (CAN)	P1	P2	P3	19	3/4	SHIMADA Daisuke (JPN)	P1	P2	P3		
	3/4		2	2	0		0	2	0		7	3	0		7	3	0		
17	3/4	STENBERG Lars Kim (SWE)	P1	P2	P3	17	0/1	STENBERG Lars Kim (SWE)	P1	P2	P3	20	1/3	SHIMADA Daisuke (JPN)	P1	P2	P3		
	3/4		2	2	0		0	1	0		1	0	2		1	0	2		
18	3/4	GRIGORYAN Grigor (ARM)	P1	P2	P3	18	3/10	GRIGORYAN Grigor (ARM)	P1	P2	P3	21	0/0	RACHAMIN Hanoc (ISR)	P1	P2	P3		
	3/4		2	2	0		7	3	0		0	0	0		0	0	0		
19	3/4	SHIMADA Daisuke (JPN)	P1	P2	P3	19	1/3	SHIMADA Daisuke (JPN)	P1	P2	P3	22	4/13	MAKIEV Zaur (RUS)	P1	P2	P3		
	3/4		2	2	0		1	0	2		6	7	0		6	6	0		
20	3/4	AITZHANOV Saken (KAZ)	P1	P2	P3	20	3/6	AITZHANOV Saken (KAZ)	P1	P2	P3	23	1/2	SHABERDIYEV O. (TKM)	P1	P2	P3		
	3/4		2	2	0		0	4	2		1	1	0		1	1	0		
21	3/4	RACHAMIN Hanoc (ISR)	P1	P2	P3	21	0/0	RACHAMIN Hanoc (ISR)	P1	P2	P3	24	4/14	LUPU Sergiu (MDA)	P1	P2	P3		
	3/4		2	2	0		0	0	0		7	7	0		0	0	0		
22	3/4	MAKIEV Zaur (RUS)	P1	P2	P3	22	4/13	MAKIEV Zaur (RUS)	P1	P2	P3	25	3/9	DOG DURBEK UULU E. (KGZ)	P1	P2	P3		
	3/4		2	2	0		6	7	0		2	7	0		2	7	0		
23	3/4	SHABERDIYEV O. (TKM)	P1	P2	P3	23	1/2	SHABERDIYEV O. (TKM)	P1	P2	P3	26	0/0	BARVA Marek (CZE)	P1	P2	P3		
	3/4		2	2	0		1	1	0		0	0	0		0	0	0		
24	3/4	LUPU Sergiu (MDA)	P1	P2	P3	24	4/14	LUPU Sergiu (MDA)	P1	P2	P3	27	0/0	AZZHAR H. (INA)	P1	P2	P3		
	3/4		2	2	0		7	7	0		2	0	0		2	0	0		
25	3/4	DOG DURBEK UULU E. (KGZ)	P1	P2	P3	25	3/9	DOG DURBEK UULU E. (KGZ)	P1	P2	P3	28	3/2	MGL	P1	P2	P3		
	3/4		2	2	0		2	7	0		1	1	0		1	1	0		
26	3/4	BARVA Marek (CZE)	P1	P2	P3	26	0/0	BARVA Marek (CZE)	P1	P2	P3	29	1/8	IMANOV Niyaz (UKR)	P1	P2	P3		
	3/4		2	2	0		0	0	0		4	4	0		4	4	0		
27	3/4	AZZHAR H. (INA)	P1	P2	P3	27	1/2	AZZHAR H. (INA)	P1	P2	P3	30	3/8	KAVALIOU Uladzimir (BLR)	P1	P2	P3		
	3/4		2	2	0		2	0	0		2	3	0		2	3	0		
28	3/4	BAATAR Nyambayar (MGL)	P1	P2	P3	28	4/14	BAATAR Nyambayar (MGL)	P1	P2	P3	31	3/5	DEEPAK Deepak (IND)	P1	P2	P3		
	3/4		2	2	0		8	6	0		1	5	0		1	5	0		
29	1/8	IMANOV Niyaz (UKR)	P1	P2	P3	29	0/0	KAVALIOU Uladzimir (BLR)	P1	P2	P3	32	1/2	LAWRENCE J. (AUS)	P1	P2	P3		
	1/8		4	4	0		0	0	0		1	1	0		1	1	0		
30	3/8	KAVALIOU Uladzimir (BLR)	P1	P2	P3	30	0/0	KAVALIOU Uladzimir (BLR)	P1	P2	P3	33	0/0	AKRITIDIS Michail (GRE)	P1	P2	P3		
	3/8		2	3	0		0	0	0		0	0	0		0	0	0		
31	3/5	DEEPAK Deepak (IND)	P1	P2	P3	31	3/6	DEEPAK Deepak (IND)	P1	P2	P3	34	3/8	OZMEN Abdulkadir (TUR)	P1	P2	P3		
	3/5		2	3	0		1	5	0		5	3	0		5	3	0		
32	1/2	LAWRENCE J. (AUS)	P1	P2	P3	32	0/0	OZMEN Abdulkadir (TUR)	P1	P2	P3	35	9/7	DIERINGER Alex (USA)	P1	P2	P3		
	1/2		1	1	0		0	0	0		7	0	0		7	0	0		
33	0/0	AKRITIDIS Michail (GRE)	P1	P2	P3	33	3/8	OZMEN Abdulkadir (TUR)	P1	P2	P3	36	0/0	TADSAPOL Pasawang (THA)	P1	P2	P3		
	0/0		0	0	0		0	0	0		0	2	0		0	2	0		
34	3/7	OZMEN Abdulkadir (TUR)	P1	P2	P3	34	3/8	OZMEN Abdulkadir (TUR)	P1	P2	P3	37	0/0	TADSAPOL Pasawang (THA)	P1	P2	P3		
	3/7		2	5	0		0	0	0		0	0	0		0	0	0		
35	9/7	DIERINGER Alex (USA)	P1	P2	P3	35	1/2	DIERINGER Alex (USA)	P1	P2	P3	38	0/0	TADSAPOL Pasawang (THA)	P1	P2	P3		
	9/7		7	0	0		0	2	0		0	0	0		0	0	0		
36	0/0	TADSAPOL Pasawang (THA)	P1	P2	P3	36	0/0	TADSAPOL Pasawang (THA)	P1	P2	P3	39	0/0	TADSAPOL Pasawang (THA)	P1	P2	P3		
	0/0		0	0	0		0	2	0		0	0	0		0	0	0		



Feuille de compétition / Competition Sheet

Championnat du Monde - Junior

STYLE : FS 74 kg



Classement

Cl	Pays	Nom
1	RUS	MAKIEV Zaur
2	GER	DUDAROV Ahmed Ruslanovic
3	GEO	KVELASHVILI Jumber
3	MGL	BAATAR Nyambayar
5	AZE	USUBZADA Eljan
5	ARM	GRIGORYAN Grigor
7	TUR	OZMEN Abdulkadir
8	MDA	LUPU Sergiu
9	IND	DEEPAK Deepak
10	ROU	UTA Remus Sebastian
11	LAT	RUHLE Andris Andreas
12	USA	DIERINGER Alex
13	VIE	CAN Tat Du
14	EGY	ZAGHLOUL Mohamed Aly
15	KAZ	AITZHANOV Saken
16	PUR	SOLER TANCO Francisco Daniel
17	CHN	YAN Ziling
18	KGZ	DOGDURBEK UULU Elaman
19	BLR	KAVALIOU Uladzimir
20	UKR	IMANOV Niyaz

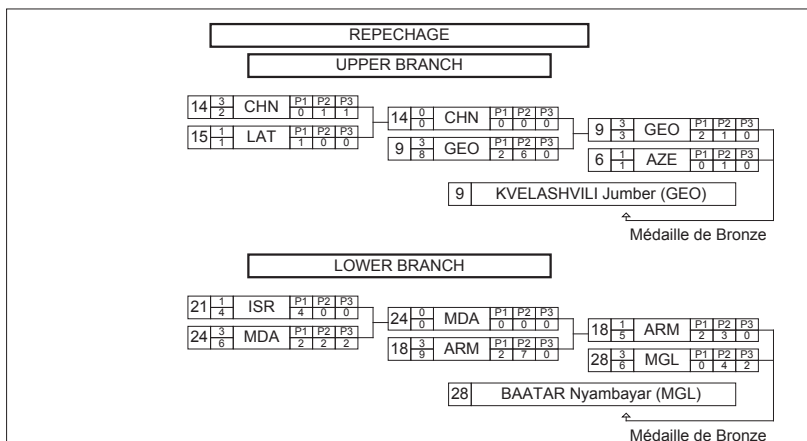



Classement

Championnat du Monde - Junior

STYLE : FS 74 kg



1 - Or / Gold



MAKIEV Zaur

2 - Argent / Silver



DUDAROV Ahmed Ruslanovic

3 - Bronze



KVELASHVILI Jumber



BAATAR Nyambayar

Classement	Nom - Name	Pays - Country
1	MAKIEV Zaur	RUS
2	DUDAROV A.	GER
3	KVELASHVILI Jumber	GEO
3	BAATAR Nyambayar	MGL
5	USUBZADA Eljan	AZE
5	GRIGORYAN Grigor	ARM
7	OZMEN Abdulkadir	TUR
8	LUPU Sergiu	MDA
9	DEEPAK Deepak	IND
10	UTA Remus Sebastian	ROU
11	RUHLE A.	LAT
12	DIERINGER Alex	USA
13	CAN Tat Du	VIE
14	ZAGHLOUL M.	EGY
15	AITZHANOV Saken	KAZ
16	SOLER TANCO F.	PUR
17	YAN Ziling	CHN
18	DOGDURBEK UULU E.	KGZ
19	KAVALIOU Uladzimir	BLR
20	IMANOV Niyaz	UKR
21	ABBASI M.	IRI
22	KACI Sid Ali	ALG
23	RACHAMIN Hanoc	ISR
24	SHIMADA Daisuke	JPN
25	LAWRENCE J.	AUS
26	KIM Hee-Jin	KOR
27	SHABERDIYEV O.	TKM
27	AZZHAR H.	INA
29	GULYAS Z.	HUN
30	WEBB Dalton James	CAN



Classement

Championnat du Monde - Junior

STYLE : FS 74 kg

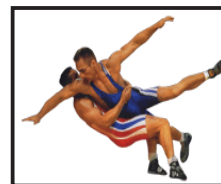

<i>Classement</i>	<i>Nom - Name</i>	<i>Pays - Country</i>
31	STENBERG Lars Kim	SWE
32	KUNNAS Jere Jaakko	FIN
33	AKRITIDIS Michail	GRE
33	TADSAPOL Pasawang	THA
35	BARVA Marek	CZE
36	MAZUREK Hubert	POL



Feuille de compétition / Competition Sheet

Championnat du Monde - Junior

STYLE : FS 84 kg



QUALIFICATION			1/8 FINALE			1/4 FINALE			1/2 FINALE			FINALE		
1	BATDORJ Namkhai (MGL)		1	MGL	1 0 0	2	KOR	1 1 0	3	USA	5 6 0	3	USA	2 0 0
2	GWON Hyeok-Beom (KOR)		2	KOR	2 4 0	3	USA	1 0 3	3	USA	3 3 0	3	USA	2 0 0
3	DOWNEY Pat (USA)		3	USA	1 0 3	6	JPN	0 3 2	9	ARM	2 0 0	24	IRI	1 1 4
4	EREMEIV Evgheni (MDA)		4	MDA	1 1 0	9	ARM	3 2 3	24	IRI	1 1 1			
5	MOHAMED Hossam (EGY)		5	EGY	6 2 0	10	UKR	7 5 0						
6	KAMEYAMA Akihiro (JPN)	4 2 0	6	JPN	7 3 0	14	RUS	4 2 0						
7	METHEE Tepakam (THA)	0 1 0	9	ARM	0 9 2	14	RUS	2 1 0						
8	MYKHALCHENKO V. (ISR)	0 0 0	10	UKR	3 0 0	14	RUS	0 1 0						
9	TAMRAZYAN Vahe (ARM)	3 6 0	12	BUL	0 0 0	18	KAZ	2 1 0						
10	KNYGIN Iaroslav (UKR)	0 4 6	14	RUS	3 1 0	18	KAZ	3 0 0						
11	ERDIN Fatih (TUR)	3 0 0	14	RUS	2 1 0	21	IND	0 0 0						
12	SOFIADI V. (BUL)	4 0 0	17	CAN	0 0 0	22	AZE	0 0 0						
13	UMETALIEV Adilet (KGZ)	0 0 0	18	KAZ	2 3 0	24	IRI	1 3 0						
14	KUDIYAMAGOMEDOV S. (RUS)	3 1 0	19	UZB	0 0 0	24	IRI	1 1 0						
15	HUSHTYN Aliaksandr (BLR)	0 0 0	20	POL	0 1 0	26	HUN	0 0 0						
16	BODNAR Michael (SVK)	1 0 0	21	IND	0 0 0									
17	PHULKA J. (CAN)	0 3 2	22	AZE	5 5 0									
18	ABDRASHEV Yeraly (KAZ)	2 3 0	24	IRI	1 3 0									
19	ODINAYEV S. (UZB)	0 0 0	25	GRE	1 0 3									
20	DUBLINOWSKI P. (POL)	0 1 0	26	HUN	7 6 0									
21	PAWAN Kumar (IND)	2 0 2	27	AUS	0 0 0									
22	XATIYER M. (AZE)	2 2 0												
23	GOGRICHIANI Levan (GEO)	0 1 0												
24	EBRAHIMIZIVLAEI M. (IRI)	1 0 4												
25	XENIDIS Timofei (GRE)	1 0 3												
26	GYURITS Gergely (HUN)	7 6 0												
27	VERREYNNE N. (AUS)	0 0 0												

24 EBRAHIMIZIVLAEI M. (IRI)

Classement

Cl	Pays	Nom
1	IRI	EBRAHIMIZIVLAEI Mohammadjavad
2	USA	DOWNEY Pat
3	RUS	KUDIYAMAGOMEDOV Shamil
3	MDA	EREMEIV Evgheni
5	AZE	XATIYER Maganedgadji
5	ARM	TAMRAZYAN Vahe
7	KAZ	ABDRASHEV Yeraly
8	JPN	KAMEYAMA Akihiro
9	BUL	SOFIADI Valentin Rahmat
10	HUN	GYURITS Gergely
11	GRE	XENIDIS Timofei
12	UKR	KNYGIN Iaroslav
13	KOR	GWON Hyeok-Beom
14	CAN	PHULKA Jasmit Singh
15	IND	PAWAN Kumar
16	EGY	MOHAMED Hossam
17	TUR	ERDIN Fatih
18	POL	DUBLINOWSKI Patryk Mateusz
18	GEO	GOGRICHIANI Levan
20	SVK	BODNAR Michael
21	THA	METHEE Tepakam
21	MGL	BATDORJ Namkhai
23	KGZ	UMETALIEV Adilet
23	BLR	HUSHTYN Aliaksandr
25	UZB	ODINAYEV Shavkatjon
26	ISR	MYKHALCHENKO Valentyn David
27	AUS	VERREYNNE Nicolaas Christiaan

REPECHAGE

REPECHAGE FINALISTE 1

4	MDA	1 1 0	4	MDA	5 1 0
2	KOR	0 0 0	9	ARM	3 0 0

4 EREMEIV Evgheni (MDA)

Mdaille de Bronze

REPECHAGE FINALISTE 2

25	GRE	4 6 0	25	GRE	1 1 0	22	AZE	2 3 0
26	HUN	3 3 0	22	AZE	5 4 0	14	RUS	2 0 0

1 KUDIYAMAGOMEDOV S. (RUS)

Mdaille de Bronze



Classement

Championnat du Monde - Junior



STYLE : FS 84 kg

1 - Or / Gold



EBRAHIMIZIVLAEI Mohammadjavad Moh

2 - Argent / Silver



DOWNEY Pat

3 - Bronze



KUDIYAMAGOMEDOV Shamil



EREMEIV Evgheni

Classement	Nom - Name	Pays - Country
1	EBRAHIMIZIVLAEI M.	IRI
2	DOWNEY Pat	USA
3	KUDIYAMAGOMEDOV S.	RUS
3	EREMEIV Evgheni	MDA
5	XATIYER M.	AZE
5	TAMRAZYAN Vahe	ARM
7	ABDRASHEV Yeraly	KAZ
8	KAMEYAMA Akihiro	JPN
9	SOFIADI V.	BUL
10	GYURITS Gergely	HUN
11	XENIDIS Timofei	GRE
12	KNYGIN Iaroslav	UKR
13	GWON Hyeok-Beom	KOR
14	PHULKA Jasmit Singh	CAN
15	PAWAN Kumar	IND
16	MOHAMED Hossam	EGY
17	ERDIN Fatih	TUR
18	DUBLINOWSKI P.	POL
18	GOGRICHIANI Levan	GEO
20	BODNAR Michael	SVK
21	METHEE Tepakam	THA
21	BATDORJ Namkhai	MGL
23	UMETALIEV Adilet	KGZ
23	HUSHTYN Aliaksandr	BLR
25	ODINAYEV Shavkatjon	UZB
26	MYKHALCHENKO V.	ISR
27	VERREYNNE N.	AUS



Feuille de compétition / Competition Sheet

Championnat du Monde - Junior

STYLE : FS 96 kg



QUALIFICATION		1/8 FINALE		1/4 FINALE		1/2 FINALE		FINALE	
1	KIM Jung Kil (KOR)	1	1 KOR	1	2	2	0	4	3
2	HUTTER P. (SUI)	2	2 SUI	2	3	4	3	4	5
3	KOLEV K. (BUL)	3	3 BUL	3	4	4	3	4	5
4	MIRZAEISHAFE M. (IRI)	4	4 IRI	4	3	4	3	4	5
5	VLASOV Andriy (UKR)	5	5 UKR	5	1	6	1	6	1
6	HARBUNOU Dzmityr (BLR)	6	6 BLR	6	3	8	0	8	0
7	OTTO Riley (CAN)	7	7 CAN	7	1	8	3	8	3
8	BOCEOGLU Ali (TUR)	8	8 TUR	8	3	10	3	10	3
9	MOURANTIDIS A. (GRE)	9	9 GRE	9	1	10	1	10	1
10	FERDINAND R. (GER)	10	10 GER	10	3	10	1	10	1
11	KAZISHVILI Viktor (ARM)	11	11 ARM	11	3	12	1	12	1
12	DORJKHAND K. (MGL)	12	12 MGL	12	1	12	1	12	1
13	BERDE Roland (HUN)	13	13 HUN	13	1	14	1	14	1
14	YAMAMOTO Koki (JPN)	14	14 JPN	14	1	16	1	16	1
15	BARAN Robert (POL)	15	15 POL	15	1	18	1	18	1
16	HALL Tanner Mark (USA)	16	16 USA	16	3	18	3	18	3
17	MESHVILDISHVILI G. (GEO)	17	17 GEO	17	3	19	3	19	3
18	NUROV M. (RUS)	18	18 RUS	18	3	19	3	19	3
19	SHARIPOV Gadzhi (AZE)	19	19 AZE	19	3	19	3	19	3
20	SUMAT Apairat (THA)	20	20 THA	20	3	22	3	22	3
21	SUMEET Sumeet (IND)	21	21 IND	21	3	22	3	22	3
22	INKAR Yermukambet (KAZ)	22	22 KAZ	22	3	22	3	22	3

4 MIRZAEISHAFE M. (IRI)

Classement

Cl	Pays	Nom
1	IRI	MIRZAEISHAFE Mehran Behzad
2	AZE	SHARIPOV Gadzhi
3	KAZ	INKAR Yermukambet
3	TUR	BOCEOGLU Ali
5	SUI	HUTTER Philipp marcel
5	GER	FERDINAND Robin Michael
7	MGL	DORJKHAND Khuderbulga
8	RUS	NUROV Magomedgadzi
9	USA	HALL Tanner Mark
10	JPN	YAMAMOTO Koki
11	BLR	HARBUNOU Dzmityr
12	ARM	KAZISHVILI Viktor
13	GRE	MOURANTIDIS Asygrkritos
14	GEO	MESHVILDISHVILI Giorgi
15	CAN	OTTO Riley
16	IND	SUMEET Sumeet
17	KOR	KIM Jung Kil
18	UKR	VLASOV Andriy
19	BUL	KOLEV Kaloyan Donev
20	HUN	BERDE Roland
21	POL	BARAN Robert
22	THA	SUMAT Apairat

REPECHAGE

REPECHAGE FINALISTE 1

3	1	BUL	P1	P2	P3	2	1	SUI	P1	P2	P3
2	3	SUI	P1	P2	P3	8	3	TUR	P1	P2	P3

8 BOCEOGLU Ali (TUR)

Mdaille de Bronze

REPECHAGE FINALISTE 2

20	0	THA	P1	P2	P3	22	3	KAZ	P1	P2	P3
22	4	KAZ	P1	P2	P3	18	0	RUS	P1	P2	P3

22 INKAR Yermukambet (KAZ)

Mdaille de Bronze



Classement

Championnat du Monde - Junior



STYLE : FS 96 kg

1 - Or / Gold



MIRZAEISHAFE Mehran Behzad

2 - Argent / Silver



SHARIPOV Gadzhi

3 - Bronze



INKAR Yermukambet



BOCEOGLU Ali

Classement	Nom - Name	Pays - Country
1	MIRZAEISHAFE M.	IRI
2	SHARIPOV Gadzhi	AZE
3	INKAR Yermukambet	KAZ
3	BOCEOGLU Ali	TUR
5	HUTTER P.	SUI
5	FERDINAND R.	GER
7	DORJKHAND K.	MGL
8	NUROV Magomedgadzhi	RUS
9	HALL Tanner Mark	USA
10	YAMAMOTO Koki	JPN
11	HARBUNOU Dzmitry	BLR
12	KAZISHVILI Viktor	ARM
13	MOURANTIDIS A.	GRE
14	MESHVILDISHVILI G.	GEO
15	OTTO Riley	CAN
16	SUMEET Sumeet	IND
17	KIM Jung Kil	KOR
18	VLASOV Andriy	UKR
19	KOLEV Kaloyan Donev	BUL
20	BERDE Roland	HUN
21	BARAN Robert	POL
22	SUMAT Apairat	THA

CHAMPIONNAT DU MONDE - JUNIOR



PATTAYA (THA)

2012

Résultats - Results

Lutte Féminine - Female-Wrestling



**Liste des arbitres / Referee list****Championnat du Monde - Junior**

N°	Licence	Pays Country	Nom - Last Name	Prénom - First Name
1	4696	BLR	BREL	Ihar
2	3231	TPE	JANG	Tsong-Rong
3	4150	ROU	GYARMATI	Ferenc
4	1455	IND	SINGH	Raj
5	3051	IRI	RAMEZAN NEJAD	Ramezan Ali
6	4112	IRQ	QASSIM	Ali
7	3620	GRE	KANIDIS	Stilianos
8	3419	RUS	KOUCHKHOV	Mulid
9	3286	CHN	PAN	Hongjun
10	2696	AUT	KHALKADAROV	Anatoli
11	3973	UKR	SYTNIK	Vitaliy
12	3318	UZB	BIKTYAKOV	Ravil
13	4212	TKM	GELDIEV	Amangeldi
14	4121	KOR	SEO	Min-Won
15	4387	GER	VOLLMER	Bernd
16	4275	FIN	KUNTTU	Juha
17	4688	CZE	KRENEK	Robin
18	3385	SWE	KAKAVAND	Djalal
19	3348	KGZ	AHMETOV	Meyrambek
20	2829	CRO	OCIC	Zvonko
21	3359	POL	LEBKOWSKI	Karol
22	4278	ROU	OLARU	Marius
23	2648	IRI	EMAMI	Mohammad Ebrahim
24	3850	IRQ	SAIWAN	Ali Mohammed
25	4711	THA	SATJATHAMNUKUL	Pulsak
26	4517	IND	KUMAR	Ashok
27	3767	RUS	ZASEEV	Soltan
28	4421	FRA	MENU-HRISTOV	CÃ©line
29	4173	TUR	SEREN	Ruhi
30	4076	UKR	GILIN	Oleksandr
31	4702	JPN	OKIYAMA	Isao
32	3156	ALG	NAANAA	Yacine
33	4955	CAN	MOHAMMADIAN	Abbas
34	3547	VIE	NGUYEN	Van Duyet
35	3490	IRI	SAHEB	Ardavan
36	3052	IRI	TAHMASEBI	Ali Akbar
37	3422	FRA	DAMIENS	Serge
38	4433	TUR	SEN	Levent
39	4754	EGY	HALAWA	Sherif Ali Ali Ahmed

**Liste des arbitres / Referee list****Championnat du Monde - Junior**

N°	Licence	Pays Country	Nom - Last Name	Prénom - First Name
40	4598	IRQ	HADI HASSAN	Esmaeel
41	4404	USA	BLACKSHEAR	Danny
42	4518	IND	PARSAD	Rajender
43	4508	GRE	LIAKOS	Christos
44	4729	RUS	ARUSTAMYAN	Noravard
45	4701	MGL	GANBOLD	Khadkhuu
46	4689	NOR	HAMMER	Thomas
47	4635	BUL	NEDEV	Stoyko Atanasov
48	3347	AZE	ALIYEV	Garib
49	4416	AUS	PAPADOPOULOS	Larry
50	2818	CYP	LOUKA	Loukas
51	2834	ROU	GUI	Vasile
52	3456	HUN	PÁ%TERI	LÃįszlÃ³
53	4575	DEN	ZEINEL LÃœTFÃœ	Atay
54	4489	USA	GOESSL	Casey
55	4438	RUS	BUZIN	Andrei
56	4432	ROU	MREANA	Constantin Cristian
57	3053	IRI	AHMADI	Mirza Agha
58	3694	THA	NOPHARAT	Jarin
59	3430	GRE	PELETIDIS	Trifon
60	4154	FRA	BRAUN	Gilles
61	4049	MGL	BOLORMAA	Luvsan-Ish
62	4045	SVK	MLYNEK	Marek
63	4359	NOR	PEDERSEN	Bjorn Terje
64	4717	JPN	KOIKE	Kuninori
65	3467	KAZ	TAIROV	Yunus
66	4372	JOR	ALMASRI	Khaled Mohammed
67	4382	UAE	AL JUNAIBI	Khaled
68	4748	GEO	JORBENADZE	Malkhaz
69	4584	CAN	DROUGHT	Mike
70	2260	USA	DAVIDSON	Rusty
71		THA	CHOLSTN	Miss Nattha
72	5143	THA	TONGME	Pattana
73	5141	THA	CHAIKATE	Jarong
74	4712	THA	KHAMDEE	Nikom
75	5140	THA	THATSANAPHONPHISAN	Tanavat
76	5144	THA	WICHIEIN	Jirawut



Liste des nations / Countries List

Championnat du Monde - Junior



STYLE FW

Pays - Country

	ALLEMAGNE	GER
	AUSTRALIE	AUS
	AUTRICHE	AUT
	AZERBAIJAN	AZE
	BELARUS	BLR
	BRESIL	BRA
	BULGARIE	BUL
	CANADA	CAN
	CHINE	CHN
	CHINESE TAIPEI	TPE
	COREE	KOR
	ESTONIE	EST
	ETATS-UNIS	USA
	FINLANDE	FIN
	FRANCE	FRA
	GERMANY	GER
	HONDURAS	HON
	HONGRIE	HUN
	INDIA	IND
	JAPON	JPN
	KAZAKHSTAN	KAZ
	LATVIA	LAT
	MOLDAVIE	MDA
	MONGOLIE	MGL
	OUZBEKISTAN	UZB
	POLOGNE	POL
	ROUMANIE	ROU
	RUSSIE	RUS
	SUEDE	SWE
	THAILAND	THA
	TURQUIE	TUR
	UKRAINE	UKR
	VENEZUELA	VEN
	VIETNAM	VIE

Nombre de nations - Number of Countries 34

**Nombre d'engagés par nation / Number of Entries By Country****Championnat du Monde - Junior****STYLE FW**

Pays - Country	44 KG	48 KG	51 KG	55 KG	59 KG	63 KG	67 KG	72 KG	TOTAL
AUS			1						1
AUT					1	1	1		3
AZE	1	1	1	1			1		5
BLR			1	1		1	1	1	5
BRA					1				1
BUL		1	1		1	1			4
CAN	1	1	1	1	1	1	1	1	8
CHN	1	1	1	1	1	1	1	1	8
EST								1	1
FIN	1			1					2
FRA	1							1	2
GER	1	1	1	1		1			5
HON		1							1
HUN		1		1	1				3
IND	1	1	1	1	1	1	1	1	8
JPN	1	1	1	1	1	1	1	1	8
KAZ	1	1	1		1	1		1	6
KOR		1	1	1	1	1	1	1	7
LAT		1							1
MDA	1			1					2
MGL			1	1	1	1	1		5
POL		1	1	1	1	1	1		6
ROU	1	1	1			1		1	5
RUS	1	1	1	1	1	1	1	1	8
SWE	1	1	1	1	1				5
THA			1	1	1	1	1	1	6
TPE	1	1	1	1		1			5
TUR	1	1	1	1	1	1	1	1	8
UKR	1	1	1	1	1	1	1	1	8
USA	1	1	1	1	1	1	1	1	8
UZB						1			1
VEN				1					1
VIE		1		1	1				3
TOTAL	17	21	21	22	19	20	15	15	150



Nombre d'engagés par nation / Number of Entries By Country

Championnat du Monde - Junior

STYLE FW



Nombre de nations - Number of Countries 33



Liste des Engagés par pays / Entry-List By Country

Championnat du Monde - Junior

STYLE FW



AUSTRALIA (AUS)

Chef de délégation / Team Leader : LANDY, Alan
Entraîneur / Coach : LANDY, Alan
Lutteuse(s) / Wrestler(s) :
51 kg YUSSOF-GUY, Zarina Bridgitte

AUSTRIA (AUT)

Chef de délégation / Team Leader : AUSSERLEITNER, Max
Entraîneur / Coach : ERNST, Benedikt
Kiné / Medical Staff : SCHWINGER, Julia
Lutteuse(s) / Wrestler(s) :
59 kg RIEGLER, Martina
63 kg SEIDL, Sabrina
67 kg KUENZ, Martina

AZERBAIJAN (AZE)

Lutteuse(s) / Wrestler(s) :
44 kg SAFARLI, Aidan
48 kg ALIYEVA, Kamala
51 kg BAGOMEDOVA, Patimat
55 kg DUBOVSKA, Yarina
67 kg KORIN, Darya

BELARUS (BLR)

Chef de délégation / Team Leader : YEUDAKIMAVA, Hanna
MALACHENKA, Leanid
Entraîneur / Coach : KLIUCHNIK, Siarhei
ZAITSAU, Artur
ALIASHKEVICH, Leanid
Médecin / Medical Staff : ZHUKOUSKI, Aliaksandr
Lutteuse(s) / Wrestler(s) :
51 kg KURACHKINA, Iryna
55 kg SIDAKOVA, Zalina
63 kg HUCHOK, Anastasiya
67 kg FEDARASHKA, Krystsina
72 kg LEUCHANKA, Halina



Liste des Engagés par pays / Entry-List By Country

Championnat du Monde - Junior

STYLE FW



BRAZIL (BRA)

Chef de délégation / Team Leader : MACAMBIRA, Elisio
Entraîneur / Coach : GARCIA, Pedro
Lutteuse(s) / Wrestler(s) :
59 kg NUNES DE OLIVEIRA , Lais

BULGARIA (BUL)

Entraîneur / Coach : KASABOV, Petar
Lutteuse(s) / Wrestler(s) :
48 kg YANKOVA, Elitsa Atanasova
51 kg DIMITROVA, Pepa Valcheva
59 kg HRISTOVA, Mimi Nikolova
63 kg IVANOVA, Dayana Stoycheva

CANADA (CAN)

Chef de délégation / Team Leader : JAROSLAWSKI, Larry
Entraîneur / Coach : SPINNEY, David
SMITH, Bill
Médecin / Medical Staff : BOYER, Dory
Lutteuse(s) / Wrestler(s) :
44 kg HUCKLE, Darby Marie
48 kg PAPKE, Jade Amber
51 kg PARKS, Madison Bianca
55 kg WAINMAN, Liisa Irene Erin
59 kg VERHAEGHE, Ashley Dawn
63 kg STONE, Braxton Rei
67 kg YEATS, Dorothy Erzsebet
72 kg DI STASIO, Justina Renay

CHINA (CHN)

Chef de délégation / Team Leader : PENG, Zhao
LI, Shan
DONG, Shenghui
Entraîneur / Coach : XIU, Zhentao
KANG, Shihua
Médecin / Medical Staff : YANG, Chao
Kiné / Medical Staff : BAI, Junbei



Liste des Engagés par pays / Entry-List By Country

Championnat du Monde - Junior

STYLE FW



Lutteuse(s) / Wrestler(s) :

44 kg	XIE, Liqiong
48 kg	CHEN, Naixiang
51 kg	YANG, Chunling
55 kg	ZHONG, Xuechun
59 kg	FENG, Jiamin
63 kg	JI, Mengyang
67 kg	XU, Rui
72 kg	ZHOU, Feng

ESTONIA (EST)

Entraîneur / Coach : AAVIK, Arvi

Lutteuse(s) / Wrestler(s) :

72 kg	MAE, Epp
-------	----------

FINLAND (FIN)

Entraîneur / Coach : RASKA, Ahto

Lutteuse(s) / Wrestler(s) :

44 kg	UUSI-RANTA, Emilia Annina
55 kg	OLLI, Petra Maarit

FRANCE (FRA)

Entraîneur / Coach : AKA, Vincent

Kiné / Medical Staff : RAINA, Antoine

Lutteuse(s) / Wrestler(s) :

44 kg	GRUNEWALD, Tabatha
72 kg	VESCAN, Cynthia Vanessa

GERMANY (GER)

Chef de délégation / Team Leader : SCHERER, Ramona

Entraîneur / Coach : KLOUCEK, Christian
REICH, Hartmut

Médecin / Medical Staff : HUBNER, Reinhard

Kiné / Medical Staff : TRAGESER, Steffen
JENTSCH, Matthias
FRANZ, Axel



Liste des Engagés par pays / Entry-List By Country

Championnat du Monde - Junior

STYLE FW



Lutteuse(s) / Wrestler(s) :

44 kg	SCHMIEDER, Jane
48 kg	BAUMGARTNER, Katharina
51 kg	HEMMER , Nina
55 kg	NEUMAIER, Kathrin
63 kg	WIENAUGE, Nadine

HONDURAS (HON)

Entraîneur / Coach : TORRES, Humberto

Lutteuse(s) / Wrestler(s) :

48 kg	BAILEY GOMEZ, Brenda Yamyleth
-------	-------------------------------

HUNGARY (HUN)

Entraîneur / Coach : NAGY, Lajos

Lutteuse(s) / Wrestler(s) :

48 kg	DENES, Mercedesz
55 kg	JAGER, Bettina szimonetta
59 kg	KOROSI, Kitti Angela

INDIA (IND)

Lutteuse(s) / Wrestler(s) :

44 kg	CHAUDHARY, Indu
48 kg	RANI, Mamta
51 kg	TOMAR, Archana
55 kg	RITU, Ritu
59 kg	DHANDA, Pooja
63 kg	MALIK, Sakshi
67 kg	SEEMA, Seema
72 kg	KIRAN, Kiran

JAPAN (JPN)

Chef de délégation / Team Leader : ONO, Kyotaro

SUZUKI, Sakae

Entraîneur / Coach : YOSHIMURA, Shoko

SASAYAMA, Hideo

Médecin / Medical Staff : IMAI, Kazuhiro

Kiné / Medical Staff : OYAMA, Takahiro



Liste des Engagés par pays / Entry-List By Country

Championnat du Monde - Junior



STYLE FW

Lutteuse(s) / Wrestler(s) :

44 kg	MATSUMOTO, Rie
48 kg	IRIE, Yuki
51 kg	SHIDOCHI, Mareka
55 kg	MURATA, Kanako
59 kg	HAMADA, Chiho
63 kg	SATO, Haruka
67 kg	DOSHO, Sara
72 kg	ARAI, Akie

KAZAKHSTAN (KAZ)

Chef de délégation / Team Leader :	KYSTAUBAYEV, Manar
Entraîneur / Coach :	ALSHIMBAYEV, Serik NURMUKHAMBETOV, Bulat
Médecin / Medical Staff :	TOKHTAGULOV, Zhumash CHURIKOVA, Klavdiya
Kiné / Medical Staff :	STARODUBOV, Boris

Lutteuse(s) / Wrestler(s) :

44 kg	UTEGULOVA, Aidana
48 kg	NURAKHAN, Nazgul
51 kg	YALOVENKO, Kristina
59 kg	KASSYMOVA, Ayaulym
63 kg	LARIONOVA, Yekaterina
72 kg	SYZDYKOVA, Elmira

LATVIA (LAT)

Lutteuse(s) / Wrestler(s) :

48 kg	TJAPKO, Karalina
-------	------------------

MOLDOVA (MDA)

Chef de délégation / Team Leader :	SAVVA, Boris CUCUL, Mihail MARTA, Petru
---	---

Lutteuse(s) / Wrestler(s) :

44 kg	BUDEANU, Emilia
55 kg	TURCAN, Elena



Liste des Engagés par pays / Entry-List By Country

Championnat du Monde - Junior

STYLE FW



MONGOLIA (MGL)

Entraîneur / Coach : BUYANDELGER, Batbayar
LUNDEG, Badarch

Lutteuse(s) / Wrestler(s) :

51 kg	ERKHEMBAYAR, Davaachimeg
55 kg	PUREVDORJ, Orkhon
59 kg	SUKHEE , Tserenchimed
63 kg	BURNEEBAATAR, Nyamgerel
67 kg	OTGONBAT, Oyuntuya

POLAND (POL)

Chef de délégation / Team Leader : ZOLTOWSKI, Robert
Entraîneur / Coach : MARCINKIEWICZ, Marcin
Kiné / Medical Staff : NOWAK, Pawel

Lutteuse(s) / Wrestler(s) :

48 kg	JEZIERZANSKA, Sara
51 kg	KOZLOW, Paula
55 kg	KRAWCZYK, Karolina
59 kg	KROL, Agnieszka Sylwia
63 kg	ROBOCINSKA, Laura
67 kg	OSOCCA, Daria Urszula

ROMANIA (ROU)

Chef de délégation / Team Leader : PARCALABU, Razvan
Entraîneur / Coach : CORNEA, Cornel

Lutteuse(s) / Wrestler(s) :

44 kg	LINGURARU, Madalina
48 kg	VUC , Emilia Alina
51 kg	PRICOB, Simona
63 kg	GAVRILIUC, Laura Elena
72 kg	MACOVEI, Ileana Denisa

RUSSIA (RUS)

Chef de délégation / Team Leader : POPOV, Isay
Médecin / Medical Staff : GIREEV, Said
Kiné / Medical Staff : NAZARICHEV, Sergey

Lutteuse(s) / Wrestler(s) :



Liste des Engagés par pays / Entry-List By Country

Championnat du Monde - Junior



STYLE FW

44 kg	KHOMUSHKU, Aziyata
48 kg	FEDOROVA, Nadezda
51 kg	VETOSHKINA, Anzhelika
55 kg	BRİK, Valentina
59 kg	FOMENKO, Anzhela
63 kg	LYULKOVA, Maria
67 kg	BABUSHKINA, Svetlana
72 kg	PRONTSEVITCH, Yulia

SOUTH KOREA (KOR)

Lutteuse(s) / Wrestler(s) :

48 kg	CHEON, Ju-Young
51 kg	LEE, Shin-Hye
55 kg	KIM, Kyeong-Eun
59 kg	SEO, Hee-Jeong
63 kg	KIM, Hye-Bin
67 kg	LEE, Han-Bit
72 kg	LEE, Tae-Kyung

SWEDEN (SWE)

Chef de délégation / Team Leader : BESARATI, Fariborz
YAKOB, Jakob

Entraîneur / Coach : PETERSSON, Mikael
PERSSON, Roy

Lutteuse(s) / Wrestler(s) :

44 kg	FREDERIKSEN, Josefine Isabelle
48 kg	JEPPSSON, Victoria Emma
51 kg	PETERSSON, Fredrika Ida
55 kg	ANDERSSON, Liisa Saga
59 kg	HOLGERSSON, Lisa Anita

TAIPEI CHINESE (TPE)

Chef de délégation / Team Leader : JANG, Tsong-Rong

Entraîneur / Coach : TUNG, Kuo-Sheng

Lutteuse(s) / Wrestler(s) :

44 kg	LO, Wen-Ling
48 kg	CHIU, Hsin-Ju
51 kg	WANG, Chih-Yun



Liste des Engagés par pays / Entry-List By Country

Championnat du Monde - Junior



STYLE FW

55 kg YEH, An-An
63 kg CHEN, Wen-Ling

THAILAND (THA)

Lutteuse(s) / Wrestler(s) :

51 kg KANJANA, Thongkan
55 kg WOHANLUEK, Charinrat
59 kg YUPAPOR, Suttakan
63 kg JUAJAN, Prapatrida
67 kg POONMART, Banjong
72 kg THITIPORN, Decha

TURKEY (TUR)

Entraîneur / Coach :

KOSUJOGLU, Ismail
ARSLAN, Yilmaz
KARAMAN, Selahattin
KENDER, Suleymen
KARA, Ali Osman
ERDOGAN, Dilek

Médecin / Medical Staff :

OZTEMUR, Zekeriya

Kiné / Medical Staff :

TURKOGLU, Haydar
YURDUSEVEN, Alev
KISACIK, Tamer

Lutteuse(s) / Wrestler(s) :

44 kg DEMIRHAN, Evin
48 kg KENDER, Busra
51 kg KENDER, Merve
55 kg GUN, Bediha
59 kg SAHIN, Hafize
63 kg TOSUN, Buse
67 kg KOCYIGIT, Kiyimet
72 kg DURUKAN, Gamze

UKRAINE (UKR)

Chef de délégation / Team Leader :

BAZYLIUK, Iaroslav
KAPLUNOVSKIY, Andriy
NOSADCHYY, Eduard

Entraîneur / Coach :

YEVONOV, Volodymyr



Liste des Engagés par pays / Entry-List By Country

Championnat du Monde - Junior



STYLE FW

Médecin / Medical Staff : MOSKALENKO, Oleksandr

BARSUKOV, Oleksii

Kiné / Medical Staff : PARNAK, Andriy

Lutteuse(s) / Wrestler(s) :

44 kg	SEMKIV, Ilona
48 kg	NAKONECHNA, Mariya
51 kg	HORISHNA, Lilya
55 kg	KIT, Tetyana
59 kg	HERHEL, Oksana
63 kg	LAVRENUCHUK, Tetyana
67 kg	STANKOVA, Karyna
72 kg	LAVRENIUK, Yulia

UNITED STATES (USA)

Chef de délégation / Team Leader : ROSBOTTOM, Louis

Entraîneur / Coach : DAVIS, Link
IZBOINIKOV, Vladislav
MOORMAN, Jason

Médecin / Medical Staff : GROSSMAN, Dave
MONSEAU, AJ

Lutteuse(s) / Wrestler(s) :

44 kg	GOLSTON, Erin Simone
48 kg	GARR, Kristi Lynn
51 kg	AUGELLO, Haley Ruth
55 kg	HILDEBRANDT, Sarah Ann
59 kg	BURKERT, Jenna Rose
63 kg	RAGAN, Allison Mackenzie
67 kg	PAGE, Jennifer
72 kg	SALATA, Julia Mary

UZBEKISTAN (UZB)

Entraîneur / Coach : IBRAGIMOV, Anatoliy

Lutteuse(s) / Wrestler(s) :

63 kg	SULTAMURATOVA, Aziza
-------	----------------------

VENEZUELA (VEN)

Lutteuse(s) / Wrestler(s) :



Liste des Engagés par pays / Entry-List By Country

Championnat du Monde - Junior

STYLE FW



55 kg

JIMENEZ FERNANDEZ, Virginia Jackelin

VIETNAM (VIE)

Chef de délégation / Team Leader : NGUYEN, The Long

Entraîneur / Coach : TRAN, Van Quang

Lutteur(s) / Wrestler(s) :

48 kg VU, Thi Hang

55 kg DUONG, Thi Lan

59 kg PHAM, Thi Loan



Feuille de compétition / Competition Sheet

Championnat du Monde - Junior



STYLE : FW 44 kg

QUALIFICATION		1/8 FINALE		1/4 FINALE		1/2 FINALE		FINALE	
1	UUSI-RANTA E. (FIN)	1	1	1	1	3	0	0	
2	BUDEANU Emilia (MDA)	2	3	2	0	3	0	1	
3	CHAUDHARY Indu (IND)	3	3	3	5	3	0	0	
4	KHOMUSHKU Aziyata (RUS)	4	0	3	7	7	0	0	
5	FREDERIKSEN J. (SWE)	5	0	6	0	0	0	0	
6	DEMIRHAN Evin (TUR)	6	3	7	5	7	0	0	
7	MATSUMOTO Rie (JPN)	7	3	7	3	6	1	1	
8	SCHMIEDER Jane (GER)	8	0	7	3	6	1	5	
9	SEMKIV Ilona (UKR)	9	3	9	3	8	6	2	
10	HUCKLE Darby Marie (CAN)	10	1	9	3	8	6	2	
11	GRUNEWALD Tabatha (FRA)	11	1	12	0	1	0	1	
12	UTEGULOVA Aidana (KAZ)	12	3	12	0	2	1	0	
13	SAFARLI Aidan (AZE)	13	1	14	1	2	1	0	
14	LINGURARU Madalina (ROU)	14	3	14	3	3	2	0	
15	GOLSTON E. (USA)	15	3	15	0	4	1	0	
16	XIE Liqiong (CHN)	16	0	15	3	2	0	1	
17	LO Wen-Ling (TPE)	17	0	16	0	3	0	0	

7 MATSUMOTO Rie (JPN)

Classement

Cl	Pays	Nom
1	JPN	MATSUMOTO Rie
2	UKR	SEMKIV Ilona
3	IND	CHAUDHARY Indu
3	USA	GOLSTON Erin Simone
5	TUR	DEMIRHAN Evin
5	KAZ	UTEGULOVA Aidana
7	CHN	XIE Liqiong
8	ROU	LINGURARU Madalina
9	MDA	BUDEANU Emilia
10	AZE	SAFARLI Aidan
11	FRA	GRUNEWALD Tabatha
12	FIN	UUSI-RANTA Emilia Annina
13	CAN	HUCKLE Darby Marie
14	TPE	LO Wen-Ling
15	SWE	FREDERIKSEN Josefine Isabelle
16	GER	SCHMIEDER Jane
17	RUS	KHOMUSHKU Aziyata

REPECHAGE

REPECHAGE FINALISTE 1

8	0	0	GER	P1	P2	P3			
6	3	2	TUR	P1	P2	P3			
3	3	2	IND	P1	P2	P3			

3 CHAUDHARY Indu (IND)

Mdaille de Bronze

REPECHAGE FINALISTE 2

10	0	0	CAN	P1	P2	P3			
12	3	2	KAZ	P1	P2	P3			
15	3	6	USA	P1	P2	P3			

15 GOLSTON E. (USA)

Mdaille de Bronze



Classement

Championnat du Monde - Junior



STYLE : FW 44 kg

1 - Or / Gold



MATSUMOTO Rie

2 - Argent / Silver



SEMKIV Ilona

3 - Bronze



CHAUDHARY Indu



GOLSTON Erin Simone

<i>Classement</i>	<i>Nom - Name</i>	<i>Pays - Country</i>
1	MATSUMOTO Rie	JPN
2	SEMKIV Ilona	UKR
3	CHAUDHARY Indu	IND
3	GOLSTON Erin Simone	USA
5	DEMIRHAN Evin	TUR
5	UTEGULOVA Aidana	KAZ
7	XIE Liqiong	CHN
8	LINGURARU Madalina	ROU
9	BUDEANU Emilia	MDA
10	SAFARLI Aidan	AZE
11	GRUNEWALD Tabatha	FRA
12	UUSI-RANTA E.	FIN
13	HUCKLE Darby Marie	CAN
14	LO Wen-Ling	TPE
15	FREDERIKSEN J.	SWE
16	SCHMIEDER Jane	GER
17	KHOMUSHKU Aziyata	RUS



Feuille de compétition / Competition Sheet

Championnat du Monde - Junior



STYLE : FW 48 kg

QUALIFICATION		1/8 FINALE		1/4 FINALE		1/2 FINALE		FINALE	
1	KENGER Busra (TUR)	1	TUR	2	HUN	2	HUN	7	VIE
2	DENES Mercedesz (HUN)	2	HUN	4	SWE	5	HON	7	VIE
3	TJAPKO Karalina (LAT)	3	LAT	5	HON	7	VIE	16	IRIE Yuki (JPN)
4	JEPPSSON V. (SWE)	4	SWE	6	KOR	7	VIE	16	JPN
5	BAILEY GOMEZ B. (HON)	5	HON	7	VIE	10	RUS	16	JPN
6	CHEON Ju-Young (KOR)	6	KOR	8	POL	10	RUS	16	JPN
7	VU Thi Hang (VIE)	7	VIE	9	BUL	10	RUS	16	JPN
8	JEZIERZANSKA Sara (POL)	8	POL	10	RUS	13	AZE	16	JPN
9	YANKOVA E. (BUL)	9	BUL	11	KAZ	13	AZE	16	JPN
10	FEDOROVA Nadezda (RUS)	10	RUS	11	KAZ	16	JPN	16	JPN
11	NURAKHAN Nazgul (KAZ)	11	KAZ	13	AZE	16	JPN	16	JPN
12	CHIU Hsin-Ju (TPE)	12	0	13	0	16	5	8	JPN
13	ALIYEVA Kamala (AZE)	13	3	12	8	4	0	16	3
14	NAKONECHNA Mariya (UKR)	14	0	14	0	16	5	8	JPN
15	CHEN Naixiang (CHN)	15	0	16	5	8	JPN	16	3
16	IRIE Yuki (JPN)	16	5	16	5	8	JPN	16	3
17	RANI Mamta (IND)	17	0	16	5	8	JPN	16	3
18	VUC Emilia Alina (ROU)	18	3	10	7	3	0	16	3
19	GARR Kristi Lynn (USA)	19	1	18	0	2	0	16	3
20	PAPKE Jade Amber (CAN)	20	3	18	0	2	0	16	3
21	BAUMGARTNER K. (GER)	21	1	18	0	2	0	16	3

16 IRIE Yuki (JPN)

Classement

Cl	Pays	Nom
1	JPN	IRIE Yuki
2	VIE	VU Thi Hang
3	HUN	DENES Mercedesz
3	RUS	FEDOROVA Nadezda
5	ROU	VUC Emilia Alina
5	POL	JEZIERZANSKA Sara
7	AZE	ALIYEVA Kamala
8	IND	RANI Mamta
9	SWE	JEPPSSON Victoria Emma
10	CAN	PAPKE Jade Amber
11	HON	BAILEY GOMEZ Brenda Yamyleth
12	UKR	NAKONECHNA Mariya
13	KAZ	NURAKHAN Nazgul
14	GER	BAUMGARTNER Katharina
15	USA	GARR Kristi Lynn
16	BUL	YANKOVA Elitsa Atanasova
17	CHN	CHEN Naixiang
17	TUR	KENGER Busra
19	KOR	CHEON Ju-Young
20	LAT	TJAPKO Karalina
21	TPE	CHIU Hsin-Ju

REPECHAGE

REPECHAGE FINALISTE 1

8	3	POL	P1	P2	P3	1	5	0
5	1	HON	P1	P2	P3	0	1	0
8	0	POL	P1	P2	P3	0	0	0
2	3	HUN	P1	P2	P3	1	3	0

2 DENES Mercedesz (HUN)

Mdaille de Bronze

REPECHAGE FINALISTE 2

17	3	IND	P1	P2	P3	4	3	0
14	0	UKR	P1	P2	P3	0	0	0
17	1	IND	P1	P2	P3	3	2	0
18	3	ROU	P1	P2	P3	3	8	0
18	0	ROU	P1	P2	P3	2	0	0
10	5	RUS	P1	P2	P3	4	6	0

10 FEDOROVA Nadezda (RUS)

Mdaille de Bronze



Classement
Championnat du Monde - Junior



STYLE : FW 48 kg

1 - Or / Gold



IRIE Yuki

2 - Argent / Silver



VU Thi Hang

3 - Bronze



DENES Mercedesz



FEDOROVA Nadezda

<i>Classement</i>	<i>Nom - Name</i>	<i>Pays - Country</i>
1	IRIE Yuki	JPN
2	VU Thi Hang	VIE
3	DENES Mercedesz	HUN
3	FEDOROVA Nadezda	RUS
5	VUC Emilia Alina	ROU
5	JEZIERZANSKA Sara	POL
7	ALIYEVA Kamala	AZE
8	RANI Mamta	IND
9	JEPPSSON V.	SWE
10	PAPKE Jade Amber	CAN
11	BAILEY GOMEZ B.	HON
12	NAKONECHNA Mariya	UKR
13	NURAKHAN Nazgul	KAZ
14	BAUMGARTNER K.	GER
15	GARR Kristi Lynn	USA
16	YANKOVA E.	BUL
17	CHEN Naixiang	CHN
17	KENGER Busra	TUR
19	CHEON Ju-Young	KOR
20	TJAPKO Karalina	LAT
21	CHIU Hsin-Ju	TPE



Feuille de compétition / Competition Sheet

Championnat du Monde - Junior



STYLE : FW 51 kg

QUALIFICATION		1/8 FINALE		1/4 FINALE		1/2 FINALE		FINALE	
1	DIMITROVA P. (BUL)	1	0	BUL	P1	P2	P3		
			0		0	0	0		
2	HORISHNA Lilya (UKR)	2	5	UKR	P1	P2	P3		
			4		4	0	0		
3	PRICOB Simona (ROU)	3	5	ROU	P1	P2	P3		
			4		4	0	0		
4	WANG Chih-Yun (TPE)	4	0	TPE	P1	P2	P3		
			0		0	0	0		
5	TOMAR Archana (IND)	5	1	IND	P1	P2	P3		
			1		1	0	0		
6	PETERSSON F. (SWE)	6	3	SWE	P1	P2	P3		
			4		0	1	3		
7	YUSSOF-GUY Z. (AUS)	7	0	AUS	P1	P2	P3		
			0		0	0	0		
8	KENGER Merve (TUR)	8	5	TUR	P1	P2	P3		
			4		4	0	0		
9	YANG Chunling (CHN)	9	3	CHN	P1	P2	P3		
			5		3	2	0		
10	KOZLOW Paula (POL)	10	0	POL	P1	P2	P3		
			0		0	0	0		
11	VETOSHKINA A. (RUS)	11	1	RUS	P1	P2	P3		
			1		1	0	0		
12	BAGOMEDOVA Patimat (AZE)	12	3	AZE	P1	P2	P3		
			8		0	2	6		
13	YALOVENKO Kristina (KAZ)	13	1	KAZ	P1	P2	P3		
			4		2	2	0		
14	AUGELLO Haley Ruth (USA)	14	0	USA	P1	P2	P3		
			0		0	0	0		
15	ERKHEMBAYAR D. (MGL)	15	5	MGL	P1	P2	P3		
			4		1	3	0		
16	KURACHKINA Iryna (BLR)	16	1	BLR	P1	P2	P3		
			2		0	2	0		
17	HEMMER Nina (GER)	17	3	GER	P1	P2	P3		
			7		3	4	0		
18	SHIDOCHI Mareka (JPN)	18	3	JPN	P1	P2	P3		
			3		1	2	0		
19	PARKS M. (CAN)	19	0	CAN	P1	P2	P3		
			0		0	0	0		
20	LEE Shin-Hye (KOR)	20	1	KOR	P1	P2	P3		
			2		1	0	1		
21	KANJANA Thongkan (THA)	21	3	THA	P1	P2	P3		
			9		1	2	6		

15 ERKHEMBAYAR D. (MGL)

Classement

Cl	Pays	Nom
1	MGL	ERKHEMBAYAR Davaachimeg
2	TUR	KENGER Merve
3	UKR	HORISHNA Lilya
3	CHN	YANG Chunling
5	GER	HEMMER Nina
5	SWE	PETERSSON Fredrika Ida
7	AZE	BAGOMEDOVA Patimat
8	JPN	SHIDOCHI Mareka
9	ROU	PRICOB Simona
10	THA	KANJANA Thongkan
11	KAZ	YALOVENKO Kristina
12	BLR	KURACHKINA Iryna
13	KOR	LEE Shin-Hye
14	IND	TOMAR Archana
15	RUS	VETOSHKINA Anzhelika
16	USA	AUGELLO Haley Ruth
17	CAN	PARKS Madison Bianca
18	BUL	DIMITROVA Pepa Valcheva
18	TPE	WANG Chih-Yun
20	POL	KOZLOW Paula
21	AUS	YUSSOF-GUY Zarina Bridgitte

REPECHAGE

REPECHAGE FINALISTE 1

7	0	AUS	P1	P2	P3		
	0		0	0	0		
6	5	SWE	P1	P2	P3		
	11		6	5	0		
6	0	SWE	P1	P2	P3		
	1		1	0	0		
2	5	UKR	P1	P2	P3		
	7		7	0	0		

2 HORISHNA Lilya (UKR)

Mdaille de Bronze

REPECHAGE FINALISTE 2

14	0	USA	P1	P2	P3		
	3		3	0	0		
17	5	GER	P1	P2	P3		
	3		3	0	0		
17	5	GER	P1	P2	P3		
	8		5	3	0		
18	0	JPN	P1	P2	P3		
	0		0	0	0		
17	1	GER	P1	P2	P3		
	5		3	2	0		
18	0	JPN	P1	P2	P3		
	0		0	0	0		
9	4	CHN	P1	P2	P3		
	19		10	9	0		

9 YANG Chunling (CHN)

Mdaille de Bronze



Classement

Championnat du Monde - Junior



STYLE : FW 51 kg

1 - Or / Gold



ERKHEMBAYAR Davaachimeg

2 - Argent / Silver



KENGER Merve

3 - Bronze



HORISHNA Lilya



YANG Chunling

<i>Classement</i>	<i>Nom - Name</i>	<i>Pays - Country</i>
1	ERKHEMBAYAR D.	MGL
2	KENGER Merve	TUR
3	HORISHNA Lilya	UKR
3	YANG Chunling	CHN
5	HEMMER Nina	GER
5	PETERSSON F.	SWE
7	BAGOMEDOVA Patimat	AZE
8	SHIDOCHI Mareka	JPN
9	PRICOB Simona	ROU
10	KANJANA Thongkan	THA
11	YALOVENKO Kristina	KAZ
12	KURACHKINA Iryna	BLR
13	LEE Shin-Hye	KOR
14	TOMAR Archana	IND
15	VETOSHKINA A.	RUS
16	AUGELLO Haley Ruth	USA
17	PARKS M.	CAN
18	DIMITROVA P.	BUL
18	WANG Chih-Yun	TPE
20	KOZLOW Paula	POL
21	YUSSOF-GUY Z.	AUS



Feuille de compétition / Competition Sheet

Championnat du Monde - Junior



STYLE : FW 55 kg

QUALIFICATION		1/8 FINALE		1/4 FINALE		1/2 FINALE		FINALE	
1	DUONG Thi Lan (VIE)	1	1 3	VIE	P1 1	P2 2	P3 0		
2	OLLI Petra Maarit (FIN)	2	3 10	FIN	P1 2	P2 8	P3 0		
3	KRAWCZYK Karolina (POL)	3	0 0	POL	P1 0	P2 0	P3 0		
4	MURATA Kanako (JPN)	4	4 12	JPN	P1 6	P2 6	P3 0		
5	RITU Ritu (IND)	5	0 0	IND	P1 0	P2 0	P3 0		
6	PUREVDORJ Orkhon (MGL)	6	5 6	MGL	P1 6	P2 0	P3 0		
7	GUN Bediha (TUR)	7	1 3	TUR	P1 3	P2 0	P3 0		
8	JIMENEZ FERNANDEZ V. (VEN)	8	3 6	VEN	P1 0	P2 2	P3 4		
9	BRİK Valentina (RUS)	9	1 5	RUS	P1 0	P2 4	P3 1		
10	SIDAKOVA Zalina (BLR)	10	3 7	BLR	P1 2	P2 3	P3 2		
11	NEUMAIER Kathrin (GER)	11	0 0		P1 0	P2 0	P3 0		
12	ZHONG Xuechun (CHN)	12	3 9	CHN	P1 2	P2 7	P3 0		
13	ANDERSSON L. (SWE)	13	5 3		P1 3	P2 0	P3 0		
14	WAINMAN L. (CAN)	14	0 0		P1 0	P2 0	P3 0		
15	WOHANLUEK C. (THA)	15	0 0		P1 0	P2 0	P3 0		
16	KIT Tetyana (UKR)	16	5 4	UKR	P1 4	P2 0	P3 0		
17	KIM Kyeong-Eun (KOR)	17	3 8		P1 0	P2 4	P3 4		
18	JAGER B. (HUN)	18	1 4		P1 1	P2 1	P3 2		
19	YEH An-An (TPE)	19	0 0		P1 0	P2 0	P3 0		
20	DUBOVSKA Yarina (AZE)	20	5 5	AZE	P1 5	P2 0	P3 0		
21	TURCAN Elena (MDA)	21	0 0		P1 0	P2 0	P3 0		
22	HILDEBRANDT S. (USA)	22	3 3	USA	P1 0	P2 3	P3 1		

4 MURATA Kanako (JPN)

Classement

Cl	Pays	Nom
1	JPN	MURATA Kanako
2	CHN	ZHONG Xuechun
3	FIN	OLLI Petra Maarit
3	BLR	SIDAKOVA Zalina
5	UKR	KIT Tetyana
5	VEN	JIMENEZ FERNANDEZ Virginia Jacke
7	AZE	DUBOVSKA Yarina
8	MGL	PUREVDORJ Orkhon
9	SWE	ANDERSSON Liisa Saga
10	GER	NEUMAIER Kathrin
11	USA	HILDEBRANDT Sarah Ann
12	KOR	KIM Kyeong-Eun
13	RUS	BRİK Valentina
14	HUN	JAGER Bettina szimonetta
15	TUR	GUN Bediha
16	VIE	DUONG Thi Lan
17	POL	KRAWCZYK Karolina
18	MDA	TURCAN Elena
18	CAN	WAINMAN Liisa Irene Erin
20	THA	WOHANLUEK Charinrat
21	TPE	YEH An-An
22	IND	RITU Ritu

REPECHAGE

REPECHAGE FINALISTE 1

3	1 1	POL	P1 1	P2 0	P3 0
2	3 5	FIN	P1 1	P2 4	P3 0
8	0 3	VEN	P1 3	P2 0	P3 0

2 OLLI Petra Maarit (FIN)

Mdaille de Bronze

REPECHAGE FINALISTE 2

11	3 4	GER	P1 1	P2 3	P3 0
13	0 0	SWE	P1 0	P2 0	P3 0
11	1 4	GER	P1 2	P2 2	P3 0
10	3 1	BLR	P1 1	P2 0	P3 0
10	3 4	BLR	P1 2	P2 2	P3 0
16	1 1	UKR	P1 1	P2 0	P3 0

10 SIDAKOVA Zalina (BLR)

Mdaille de Bronze



Classement

Championnat du Monde - Junior



STYLE : FW 55 kg

1 - Or / Gold



MURATA Kanako

2 - Argent / Silver



ZHONG Xuechun

3 - Bronze



OLLI Petra Maarit



SIDAKOVA Zalina

Classement	Nom - Name	Pays - Country
1	MURATA Kanako	JPN
2	ZHONG Xuechun	CHN
3	OLLI Petra Maarit	FIN
3	SIDAKOVA Zalina	BLR
5	KIT Tetyana	UKR
5	JIMENEZ FERNANDEZ V.	VEN
7	DUBOVSKA Yarina	AZE
8	PUREVDORJ Orkhon	MGL
9	ANDERSSON L.	SWE
10	NEUMAIER Kathrin	GER
11	HILDEBRANDT S.	USA
12	KIM Kyeong-Eun	KOR
13	BRIK Valentina	RUS
14	JAGER B.	HUN
15	GUN Bediha	TUR
16	DUONG Thi Lan	VIE
17	KRAWCZYK Karolina	POL
18	TURCAN Elena	MDA
18	WAINMAN L.	CAN
20	WOHANLUEK Charinrat	THA
21	YEH An-An	TPE
22	RITU Ritu	IND



Feuille de compétition / Competition Sheet

Championnat du Monde - Junior



STYLE : FW 59 kg

QUALIFICATION				1/8 FINALE				1/4 FINALE				1/2 FINALE				FINALE			
1		VERHAEGHE A. (CAN)		1	1	CAN	P1 P2 P3 1 0 0	2	1	POL	P1 P2 P3 1 0 0	3	0	IND	P1 P2 P3 0 0 0	8	1	TUR	P1 P2 P3 1 0 2
2		KROL A. (POL)		2	3	POL	P1 P2 P3 3 6 0	3	3	IND	P1 P2 P3 0 1 3	6	0	CHN	P1 P2 P3 0 0 0	8	5	TUR	P1 P2 P3 3 0 0
3		DHANDA Pooja (IND)		3	3	IND	P1 P2 P3 4 4 3	3	4	IND	P1 P2 P3 0 1 3	6	0	CHN	P1 P2 P3 0 0 0	8	5	TUR	P1 P2 P3 3 0 0
4		KASSYMOVA Ayaulym (KAZ)		4	1	KAZ	P1 P2 P3 5 1 1	3	4	IND	P1 P2 P3 0 1 3	6	0	CHN	P1 P2 P3 0 0 0	8	5	TUR	P1 P2 P3 3 0 0
5		BURKERT Jenna Rose (USA)		5	0	USA	P1 P2 P3 3 2 0	6	0	CHN	P1 P2 P3 0 0 0	8	5	TUR	P1 P2 P3 3 0 0	8	5	TUR	P1 P2 P3 3 0 0
6		FENG Jiamin (CHN)		6	5	CHN	P1 P2 P3 3 2 3	6	0	CHN	P1 P2 P3 0 0 0	8	5	TUR	P1 P2 P3 3 0 0	8	5	TUR	P1 P2 P3 3 0 0
7		HOLGERSSON L. (SWE)		7	0	SWE	P1 P2 P3 0 0 0	8	5	TUR	P1 P2 P3 3 0 0	8	5	TUR	P1 P2 P3 3 0 0	8	5	TUR	P1 P2 P3 3 0 0
8		SAHIN Hafize (TUR)		8	5	TUR	P1 P2 P3 7 0 0	8	5	TUR	P1 P2 P3 3 0 0	8	5	TUR	P1 P2 P3 3 0 0	8	5	TUR	P1 P2 P3 3 0 0
9		FOMENKO Anzhela (RUS)		9	3	RUS	P1 P2 P3 0 8 2	9	1	RUS	P1 P2 P3 4 0 0	12	1	UKR	P1 P2 P3 0 3 1	13	3	JPN	P1 P2 P3 0 1 7
10		RIEGLER Martina (AUT)		10	1	AUT	P1 P2 P3 1 0 0	9	1	RUS	P1 P2 P3 4 0 0	12	1	UKR	P1 P2 P3 0 3 1	13	3	JPN	P1 P2 P3 0 1 7
11		PHAM Thi Loan (VIE)		11	1	VIE	P1 P2 P3 1 0 0	12	3	UKR	P1 P2 P3 4 1 0	12	1	UKR	P1 P2 P3 0 3 1	13	3	JPN	P1 P2 P3 0 1 7
12		HERHEL Oksana (UKR)		12	3	UKR	P1 P2 P3 3 3 0	12	3	UKR	P1 P2 P3 4 1 0	12	1	UKR	P1 P2 P3 0 3 1	13	3	JPN	P1 P2 P3 0 1 7
13		HAMADA Chiho (JPN)		13	3	JPN	P1 P2 P3 1 6 0	13	3	JPN	P1 P2 P3 1 5 0	13	3	JPN	P1 P2 P3 2 0 3	13	3	JPN	P1 P2 P3 0 1 7
14	3	HRISTOVA M. (BUL)	P1 P2 P3 2 6 0	14	0	BUL	P1 P2 P3 0 0 0	13	3	JPN	P1 P2 P3 1 5 0	13	3	JPN	P1 P2 P3 2 0 3	13	3	JPN	P1 P2 P3 0 1 7
15	1	NUNES DE OLIVEIRA L. (BRA)	P1 P2 P3 1 5 0	14	0	BUL	P1 P2 P3 0 0 0	13	3	JPN	P1 P2 P3 1 5 0	13	3	JPN	P1 P2 P3 2 0 3	13	3	JPN	P1 P2 P3 0 1 7
16	1	KOROSI K. (HUN)	P1 P2 P3 1 0 0	17	3	MGL	P1 P2 P3 1 3 0	17	0	MGL	P1 P2 P3 0 1 0	13	3	JPN	P1 P2 P3 2 0 3	13	3	JPN	P1 P2 P3 0 1 7
17	3	SUKHEE T. (MGL)	P1 P2 P3 0 1 3	17	3	MGL	P1 P2 P3 1 3 0	17	0	MGL	P1 P2 P3 0 1 0	13	3	JPN	P1 P2 P3 2 0 3	13	3	JPN	P1 P2 P3 0 1 7
18	0	YUPAPOR Suttakan (THA)	P1 P2 P3 0 0 0	19	0	KOR	P1 P2 P3 0 0 0	17	0	MGL	P1 P2 P3 0 1 0	13	3	JPN	P1 P2 P3 2 0 3	13	3	JPN	P1 P2 P3 0 1 7
19	5	SEO Hee-Jeong (KOR)	P1 P2 P3 2 4 0	19	0	KOR	P1 P2 P3 0 0 0	17	0	MGL	P1 P2 P3 0 1 0	13	3	JPN	P1 P2 P3 2 0 3	13	3	JPN	P1 P2 P3 0 1 7

13 HAMADA Chiho (JPN)

Classement

Cl	Pays	Nom
1	JPN	HAMADA Chiho
2	TUR	SAHIN Hafize
3	CHN	FENG Jiamin
3	UKR	HERHEL Oksana
5	IND	DHANDA Pooja
5	MGL	SUKHEE Tserenchimed
7	KOR	SEO Hee-Jeong
8	RUS	FOMENKO Anzhela
9	POL	KROL Agnieszka Sylwia
10	BUL	HRISTOVA Mimi Nikolova
11	KAZ	KASSYMOVA Ayaulym
12	BRA	NUNES DE OLIVEIRA Lais
13	HUN	KOROSI Kitti Angela
14	VIE	PHAM Thi Loan
15	CAN	VERHAEGHE Ashley Dawn
16	SWE	HOLGERSSON Lisa Anita
16	AUT	RIEGLER Martina
18	USA	BURKERT Jenna Rose
19	THA	YUPAPOR Suttakan

REPECHAGE

REPECHAGE FINALISTE 1

7	1	SWE	P1 P2 P3 1 0 0	6	3	CHN	P1 P2 P3 1 1 0
6	3	CHN	P1 P2 P3 0 1 2	3	0	IND	P1 P2 P3 0 0 0

6 FENG Jiamin (CHN)

Mdaille de Bronze

REPECHAGE FINALISTE 2

14	0	BUL	P1 P2 P3 0 0 0	17	1	MGL	P1 P2 P3 2 3 1
17	5	MGL	P1 P2 P3 3 1 0	12	3	UKR	P1 P2 P3 0 3 3

12 HERHEL Oksana (UKR)

Mdaille de Bronze



Classement

Championnat du Monde - Junior



STYLE : FW 59 kg

1 - Or / Gold



HAMADA Chiho

2 - Argent / Silver



SAHIN Hafize

3 - Bronze



FENG Jiamin



HERHEL Oksana

Classement	Nom - Name	Pays - Country
1	HAMADA Chiho	JPN
2	SAHIN Hafize	TUR
3	FENG Jiamin	CHN
3	HERHEL Oksana	UKR
5	DHANDA Pooja	IND
5	SUKHEE T.	MGL
7	SEO Hee-Jeong	KOR
8	FOMENKO Anzhela	RUS
9	KROL A.	POL
10	HRISTOVA M.	BUL
11	KASSYMOVA Ayaulym	KAZ
12	NUNES DE OLIVEIRA L.	BRA
13	KOROSI Kitti Angela	HUN
14	PHAM Thi Loan	VIE
15	VERHAEGHE A.	CAN
16	HOLGERSSON L.	SWE
16	RIEGLER Martina	AUT
18	BURKERT Jenna Rose	USA
19	YUPAPOR Suttakan	THA



Feuille de compétition / Competition Sheet

Championnat du Monde - Junior



STYLE : FW 63 kg

QUALIFICATION			1/8 FINALE			1/4 FINALE			1/2 FINALE			FINALE				
1	LAVRECHUK Tetyana (UKR)		1	3/6	UKR	P1	P2	P3	1	3/4	UKR	P1	P2	P3		
2	SEIDL Sabrina (AUT)		2	0/0	AUT	P1	P2	P3								
3	TOSUN Buse (TUR)		3	1/5	TUR	P1	P2	P3								
4	SATO Haruka (JPN)		4	3/6	JPN	P1	P2	P3	4	1/2	JPN	P1	P2	P3		
5	HUCHOK Anastasiya (BLR)		5	5/4	BLR	P1	P2	P3								
6	WIENAUGE Nadine (GER)		6	0/2	GER	P1	P2	P3	5	5/2	BLR	P1	P2	P3		
7	RAGAN A. (USA)		7	3/8	USA	P1	P2	P3								
8	GAVRILIUC L. (ROU)		8	1/4	ROU	P1	P2	P3	7	0/2	USA	P1	P2	P3		
9	LARIONOVA Y. (KAZ)		9	5/4	KAZ	P1	P2	P3								
10	Ji Mengyang (CHN)		10	0/0	CHN	P1	P2	P3	9	0/0	KAZ	P1	P2	P3		
11	LYULKOVA Maria (RUS)		11	5/4	RUS	P1	P2	P3								
12	MALIK Sakshi (IND)		12	0/1	IND	P1	P2	P3	11	3/7	RUS	P1	P2	P3		
13	KIM Hye-Bin (KOR)	P1	P2	P3	1	1	0	13	1/2	KOR	P1	P2	P3	1	1	0
14	JUAJAN Prapatrida (THA)	P1	P2	P3	0	1	0	16	1/2	TPE	P1	P2	P3	1	2	0
15	IVANOVA D. (BUL)	P1	P2	P3	0	2	0	16	3/4	TPE	P1	P2	P3	1	1	2
16	CHEN Wen-Ling (TPE)	P1	P2	P3	1	2	3									
17	BURNEEBAATAR N. (MGL)	P1	P2	P3	0	7	0	18	1/3	POL	P1	P2	P3	3	0	0
18	ROBOCINSKA Laura (POL)	P1	P2	P3	3	0	3	20	3/7	CAN	P1	P2	P3	1	3	3
19	SULTAMURATOVA A. (UZB)	P1	P2	P3	0	0	0	20	3/9	CAN	P1	P2	P3	0	3	6
20	STONE Braxton Rei (CAN)	P1	P2	P3	6	8	0									

5 HUCHOK Anastasiya (BLR)

Classement

Cl	Pays	Nom
1	BLR	HUCHOK Anastasiya
2	RUS	LYULKOVA Maria
3	USA	RAGAN Allison Mackenzie
3	KAZ	LARIONOVA Yekaterina
5	CAN	STONE Braxton Rei
5	UKR	LAVRECHUK Tetyana
7	TPE	CHEN Wen-Ling
8	POL	ROBOCINSKA Laura
9	JPN	SATO Haruka
10	KOR	KIM Hye-Bin
11	TUR	TOSUN Buse
12	ROU	GAVRILIUC Laura Elena
13	BUL	IVANOVA Dayana Stoycheva
14	THA	JUAJAN Prapatrida
15	MGL	BURNEEBAATAR Nyamgerel
16	GER	WIENAUGE Nadine
17	IND	MALIK Sakshi
18	CHN	Ji Mengyang
19	AUT	SEIDL Sabrina
20	UZB	SULTAMURATOVA Aziza

REPECHAGE

REPECHAGE FINALISTE 1

6	0/0	GER	P1	P2	P3	7	5/5	USA	P1	P2	P3
7	3/10	USA	P1	P2	P3	1	0/0	UKR	P1	P2	P3

7 RAGAN A. (USA)

Mdaille de Bronze

REPECHAGE FINALISTE 2

12	0/0	IND	P1	P2	P3	9	5/6	KAZ	P1	P2	P3
9	5/4	KAZ	P1	P2	P3	20	0/2	CAN	P1	P2	P3

9 LARIONOVA Y. (KAZ)

Mdaille de Bronze



Classement

Championnat du Monde - Junior



STYLE : FW 63 kg

1 - Or / Gold



HUCHOK Anastasiya

2 - Argent / Silver



LYULKOVA Maria

3 - Bronze



RAGAN Allison Mackenzie



LARIONOVA Yekaterina

<i>Classement</i>	<i>Nom - Name</i>	<i>Pays - Country</i>
1	HUCHOK Anastasiya	BLR
2	LYULKOVA Maria	RUS
3	RAGAN A.	USA
3	LARIONOVA Y.	KAZ
5	STONE Braxton Rei	CAN
5	LAVRECHUK Tetyana	UKR
7	CHEN Wen-Ling	TPE
8	ROBOCINSKA Laura	POL
9	SATO Haruka	JPN
10	KIM Hye-Bin	KOR
11	TOSUN Buse	TUR
12	GAVRILIUC L.	ROU
13	IVANOVA D.	BUL
14	JUAJAN Prapatrida	THA
15	BURNEEBAATAR N.	MGL
16	WIENAUGE Nadine	GER
17	MALIK Sakshi	IND
18	JI Mengyang	CHN
19	SEIDL Sabrina	AUT
20	SULTAMURATOVA Aziza	UZB



Feuille de compétition / Competition Sheet

Championnat du Monde - Junior



STYLE : FW 67 kg



4 YEATS D. (CAN)

Classement

Cl	Pays	Nom
1	CAN	YEATS Dorothy Erzsebet
2	RUS	BABUSHKINA Svetlana
3	JPN	DOSHO Sara
3	POL	OSOCKA Daria Urszula
5	USA	PAGE Jennifer
5	MGL	OTGONBAT Oyuntuya
7	BLR	FEDARASHKA Krystsina
8	CHN	XU Rui
9	UKR	STANKOVA Karyna
10	TUR	KOCYIGIT Kiymet
11	THA	POONMART Banjong
12	AZE	KORIN Darya
13	KOR	LEE Han-Bit
14	IND	SEEMA Seema
15	AUT	KUENZ Martina

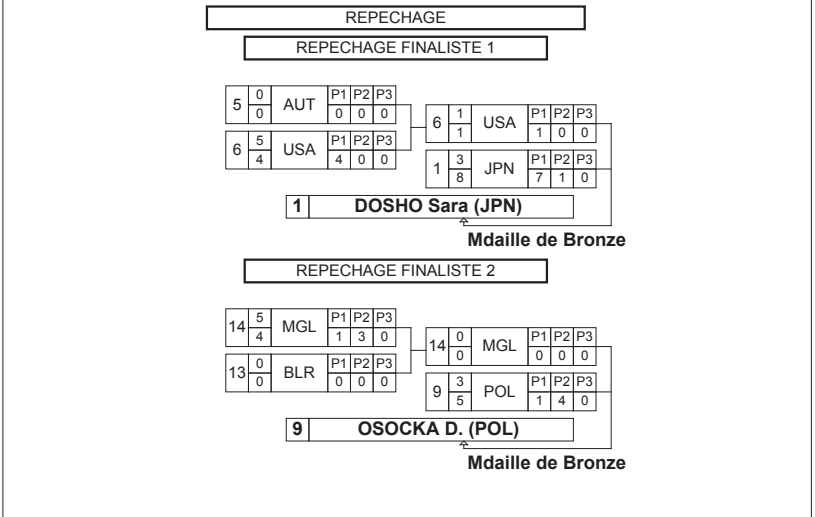



Classement
Championnat du Monde - Junior



STYLE : FW 67 kg

1 - Or / Gold



YEATS Dorothy Erzsébet

2 - Argent / Silver

BABUSHKINA Svetlana

3 - Bronze



DOSHO Sara



OSOCKA Daria Urszula

<i>Classement</i>	<i>Nom - Name</i>	<i>Pays - Country</i>
1	YEATS D.	CAN
2	BABUSHKINA Svetlana	RUS
3	DOSHO Sara	JPN
3	OSOCKA D.	POL
5	PAGE Jennifer	USA
5	OTGONBAT Oyuntuya	MGL
7	FEDARASHKA K.	BLR
8	XU Rui	CHN
9	STANKOVA Karyna	UKR
10	KOCYIGIT Kiymet	TUR
11	POONMART Banjong	THA
12	KORIN Darya	AZE
13	LEE Han-Bit	KOR
14	SEEMA Seema	IND
15	KUENZ Martina	AUT



Feuille de compétition / Competition Sheet

Championnat du Monde - Junior



STYLE : FW 72 kg



3 ZHOU Feng (CHN)

Classement

Cl	Pays	Nom
1	CHN	ZHOU Feng
2	FRA	VESCAN Cynthia Vanessa
3	TUR	DURUKAN Gamze
3	BLR	LEUCHANKA Halina
5	CAN	DI STASIO Justina Renay
5	ROU	MACOVEI Ileana Denisa
7	EST	MAE Epp
8	USA	SALATA Julia Mary
9	KOR	LEE Tae-Kyung
10	KAZ	SYZDYKOVA Elmira
11	IND	KIRAN Kiran
12	RUS	PRONTSEVITCH Yulia
13	UKR	LAVRENIUK Yuliia
14	THA	THITIPORN Decha
15	JPN	ARAI Akie

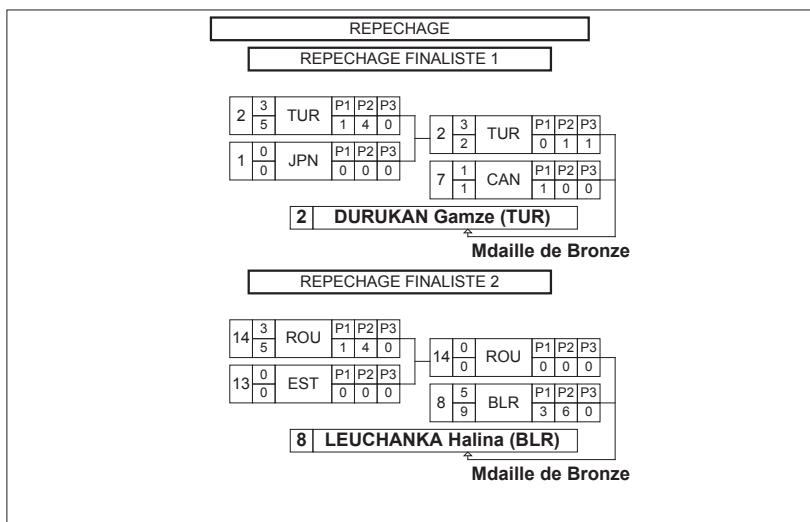



Classement

Championnat du Monde - Junior



STYLE : FW 72 kg

1 - Or / Gold



ZHOU Feng

2 - Argent / Silver



VESCAN Cynthia Vanessa

3 - Bronze



DURUKAN Gamze



LEUCHANKA Halina

Classement	Nom - Name	Pays - Country
1	ZHOU Feng	CHN
2	VESCAN C.	FRA
3	DURUKAN Gamze	TUR
3	LEUCHANKA Halina	BLR
5	DI STASIO J.	CAN
5	MACOVEI I.	ROU
7	MAE Epp	EST
8	SALATA Julia Mary	USA
9	LEE Tae-Kyung	KOR
10	SYZDYKOVA Elmira	KAZ
11	KIRAN Kiran	IND
12	PRONTSEVITCH Yulia	RUS
13	LAVRENIUK Yuliia	UKR
14	THITIPORN Decha	THA
15	ARAI Akie	JPN

CHAMPIONNAT DU MONDE - JUNIOR



PATTAYA (THA)

2012

Résultats - Results

Lutte Greco-Romaine - Greco-Roman

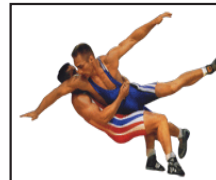
**Liste des arbitres / Referee list****Championnat du Monde - Junior**

N°	Licence	Pays Country	Nom - Last Name	Prénom - First Name
1	4696	BLR	BREL	Ihar
2	3231	TPE	JANG	Tsong-Rong
3	4150	ROU	GYARMATI	Ferenc
4	1455	IND	SINGH	Raj
5	3051	IRI	RAMEZAN NEJAD	Ramezan Ali
6	4112	IRQ	QASSIM	Ali
7	3620	GRE	KANIDIS	Stilianos
8	3419	RUS	KOUCHKHOV	Mulid
9	3286	CHN	PAN	Hongjun
10	2696	AUT	KHALKADAROV	Anatoli
11	3973	UKR	SYTNIK	Vitaliy
12	3318	UZB	BIKTYAKOV	Ravil
13	4212	TKM	GELDIEV	Amangeldi
14	4121	KOR	SEO	Min-Won
15	4387	GER	VOLLMER	Bernd
16	4275	FIN	KUNTTU	Juha
17	4688	CZE	KRENEK	Robin
18	3385	SWE	KAKAVAND	Djalal
19	3348	KGZ	AHMETOV	Meyrambek
20	2829	CRO	OCIC	Zvonko
21	3359	POL	LEBKOWSKI	Karol
22	4278	ROU	OLARU	Marius
23	2648	IRI	EMAMI	Mohammad Ebrahim
24	3850	IRQ	SAIWAN	Ali Mohammed
25	4711	THA	SATJATHAMNUKUL	Pulsak
26	4517	IND	KUMAR	Ashok
27	3767	RUS	ZASEEV	Soltan
28	4421	FRA	MENU-HRISTOV	Céline
29	4173	TUR	SEREN	Ruhi
30	4076	UKR	GILIN	Oleksandr
31	4702	JPN	OKIYAMA	Isao
32	3156	ALG	NAANAA	Yacine
33	4955	CAN	MOHAMMADIAN	Abbas
34	3547	VIE	NGUYEN	Van Duyet
35	3490	IRI	SAHEB	Ardavan
36	3052	IRI	TAHMASEBI	Ali Akbar
37	3422	FRA	DAMIENS	Serge
38	4433	TUR	SEN	Levent
39	4754	EGY	HALAWA	Sherif Ali Ali Ahmed

**Liste des arbitres / Referee list****Championnat du Monde - Junior**

N°	Licence	Pays Country	Nom - Last Name	Prénom - First Name
40	4598	IRQ	HADI HASSAN	Esmaeel
41	4404	USA	BLACKSHEAR	Danny
42	4518	IND	PARSAD	Rajender
43	4508	GRE	LIAKOS	Christos
44	4729	RUS	ARUSTAMYAN	Noravard
45	4701	MGL	GANBOLD	Khadkhuu
46	4689	NOR	HAMMER	Thomas
47	4635	BUL	NEDEV	Stoyko Atanasov
48	3347	AZE	ALIYEV	Garib
49	4416	AUS	PAPADOPOULOS	Larry
50	2818	CYP	LOUKA	Loukas
51	2834	ROU	GUI	Vasile
52	3456	HUN	PÉTERI	László
53	4575	DEN	ZEINEL LÜTFÜ	Atay
54	4489	USA	GOESSL	Casey
55	4438	RUS	BUZIN	Andrei
56	4432	ROU	MREANA	Constantin Cristian
57	3053	IRI	AHMADI	Mirza Agha
58	3694	THA	NOPHARAT	Jarin
59	3430	GRE	PELETIDIS	Trifon
60	4154	FRA	BRAUN	Gilles
61	4049	MGL	BOLORMAA	Luvsan-Ish
62	4045	SVK	MLYNEK	Marek
63	4359	NOR	PEDERSEN	Bjorn Terje
64	4717	JPN	KOIKE	Kuninori
65	3467	KAZ	TAIROV	Yunus
66	4372	JOR	ALMASRI	Khaled Mohammed
67	4382	UAE	AL JUNAIBI	Khaled
68	4748	GEO	JORBENADZE	Malkhaz
69	4584	CAN	DROUGHT	Mike
70	2260	USA	DAVIDSON	Rusty
71		THA	CHOLSTN	Miss Nattha
72	5143	THA	TONGME	Pattana
73	5141	THA	CHAIKATE	Jarong
74	4712	THA	KHAMDEE	Nikom
75	5140	THA	THATSANAPHONPHISAN	Tanavat
76	5144	THA	WICHIEIN	Jirawut













































Liste des nations / Countries List

Championnat du Monde - Junior

STYLE GR



Pays - Country

	AFRIQUE DU SUD	RSA
	ALGERIA	ALG
	ALLEMAGNE	GER
	ARMENIE	ARM
	AUTRICHE	AUT
	AZERBAIJAN	AZE
	BELARUS	BLR
	BULGARIE	BUL
	CHINE	CHN
	CHINESE TAIPEI	TPE
	COREE	KOR
	CROATIE	CRO
	EGYPT	EGY
	ETATS-UNIS	USA
	FINLANDE	FIN
	FRANCE	FRA
	GEORGIE	GEO
	GRECE	GRE
	HONDURAS	HON
	HONGRIE	HUN
	INDIA	IND
	INDONESIA	INA
	IRAN R.I.	IRI
	ISRAEL	ISR
	JAPON	JPN
	KAZAKHSTAN	KAZ
	KYRGYZSTAN	KGZ
	LITUANIE	LTU
	MEXICO	MEX
	MOLDAVIE	MDA
	MOROCCO	MAR
	NORVEGE	NOR
	OUZBEKISTAN	UZB
	POLOGNE	POL
	ROUMANIE	ROU
	RUSSIE	RUS
	SLOVAQUIE	SVK
	SUEDE	SWE
	SUISSE	SUI
	TAJIKISTAN	TJK
	TCHEQUE REP.	CZE
	THAILAND	THA
	TURKMENISTAN	TKM
	TURQUIE	TUR
	UKRAINE	UKR



Nombre d'engagés par nation / Number of Entries By Country

Championnat du Monde - Junior

STYLE GR



<i>Pays - Country</i>	<i>120 KG</i>	<i>50 KG</i>	<i>55 KG</i>	<i>60 KG</i>	<i>66 KG</i>	<i>74 KG</i>	<i>84 KG</i>	<i>96 KG</i>	<i>TOTAL</i>
ALG					1	1			2
ARM		1	1	1	1	1	1	1	7
AUT				1	1	1	1		4
AZE	1	1	1	1	1	1	1	1	8
BLR			1	1	1	1	1		5
BUL	1		1						2
CHN	1	1	1	1	1	1	1	1	8
CRO			1	1	1				3
CZE				1	1	1			3
EGY		1	1	1	1	1	1	1	7
FIN			1	1	1	1		1	5
FRA							1		1
GEO	1	1	1	1	1	1	1	1	8
GER	1		1	1	1	1	1	1	7
GRE	1				1		1	1	4
HON					1			1	2
HUN	1	1		1	1				4
INA			1						1
IND	1	1	1	1	1	1	1	1	8
IRI	1	1	1	1	1	1	1	1	8
ISR		1	1					1	3
JPN	1	1	1	1	1	1	1	1	8
KAZ		1	1	1	1	1	1	1	7
KGZ			1	1	1	1	1	1	6
KOR	1	1	1	1	1	1	1	1	8
LTU				1		1	1	1	4
MAR					1	1			2
MDA			1	1	1				3
MEX		1							1
NOR				1	1			1	3
POL				1	1	1	1		4
ROU		1		1	1	1	1		5
RSA			1						1

**Nombre d'engagés par nation / Number of Entries By Country****Championnat du Monde - Junior**

STYLE GR

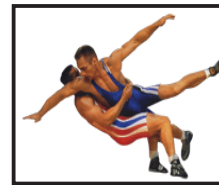

<i>Pays - Country</i>	<i>120 KG</i>	<i>50 KG</i>	<i>55 KG</i>	<i>60 KG</i>	<i>66 KG</i>	<i>74 KG</i>	<i>84 KG</i>	<i>96 KG</i>	<i>TOTAL</i>
RUS	1	1	1	1	1	1	1	1	8
SUI						1			1
SVK					1			1	2
SWE			1		1	1		1	4
THA	1	1	1	1	1	1	1	1	8
TJK			1		1		1		3
TKM					1	1	1		3
TPE					1				1
TUR	1	1	1	1	1	1	1	1	8
UKR	1	1	1	1	1	1	1	1	8
USA	1	1	1	1	1	1	1	1	8
UZB	1		1	1			1	1	5
TOTAL	17	19	28	29	36	29	27	26	211

Nombre de nations - Number of Countries **45**



Liste des Engagés par pays / Entry-List By Country

Championnat du Monde - Junior

STYLE GR



ALGERIA (ALG)

Lutteur(s) / Wrestler(s) :

66 kg	BOUDJEMPLINE, Akrem
74 kg	OUAKALI, Abdelkrim

ARMENIA (ARM)

Chef de délégation / Team Leader : ARAQELYAN, Bazmaser
YENOKYAN, Hrant

Entraîneur / Coach : BABALARYAN, Armen
MOVSES, Karapetyan
PETROSYAN, Artur

Lutteur(s) / Wrestler(s) :

50 kg	MKRTCHYAN, Rudik
55 kg	GHARIBYAN, Gevorg
60 kg	KHACHATRYAN, Vazgen
66 kg	ARSHAKYAN, Hayk
74 kg	CHALYAN, Karapet
84 kg	PETROSYAN, Varos
96 kg	SIMONYAN, Vahe

AUSTRIA (AUT)

Chef de délégation / Team Leader : AUSSERLEITNER, Max

Entraîneur / Coach : WALCHER, Walter

Kiné / Medical Staff : SCHWINGER, Julia

Lutteur(s) / Wrestler(s) :

60 kg	MARCHL, Anton
66 kg	STEIGL, Stefan
74 kg	WAGNER, Michael
84 kg	GASTL, Daniel

AZERBAIJAN (AZE)

Lutteur(s) / Wrestler(s) :

120 kg	MEXRALIYEN, Zaur
50 kg	BAZAROV, Murad
55 kg	AZIZLI, Eldaniz
60 kg	TAGHIYEV, Rovshan
66 kg	ALIYEV, Ceyxhun



Liste des Engagés par pays / Entry-List By Country

Championnat du Monde - Junior

STYLE GR

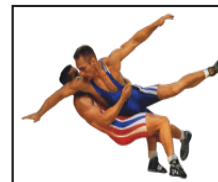

74 kg	ERTUGANOV, Shamil
84 kg	ALIYEV, Fuad
96 kg	ABDULLAYEV, Abas

BELARUS (BLR)

Chef de délégation / Team Leader :	YEUDAKIMAVA, Hanna MALACHENKA, Leanid
Entraîneur / Coach :	MIKHALOVICH, Aleh KAZOUSKI, Aliaksandr KIBKOV, Vladimir
Médecin / Medical Staff :	ZHUKOUSKI, Aliaksandr

Lutteur(s) / Wrestler(s) :

55 kg	ASTAPOVICH, Aliaksandr
60 kg	DZIVACHENKA, Kanstantsin
66 kg	YELAK, Aliaksei
74 kg	KILOU, Kazbek
84 kg	HAHNIDZE, Hoha

BULGARIA (BUL)

Entraîneur / Coach :	MARINOV, Dobri TODOROV, Todor DACHEV, Nikolay
-----------------------------	---

Lutteur(s) / Wrestler(s) :

120 kg	METHODIEV, Miloslav Yuriev
55 kg	VICHEV, Nikolay Ivanov

CHINA (CHN)

Chef de délégation / Team Leader :	PENG, Zhao LI, Shan DONG, Shenghui
Entraîneur / Coach :	WANG, Changsheng FAN, Yanjun
Médecin / Medical Staff :	YANG, Chao
Kiné / Medical Staff :	BAI, Junbei

Lutteur(s) / Wrestler(s) :

120 kg	ZHANG, Yannan
50 kg	FANG, Haibin
55 kg	ZHAO, Gaoyuan



Liste des Engagés par pays / Entry-List By Country

Championnat du Monde - Junior

STYLE GR

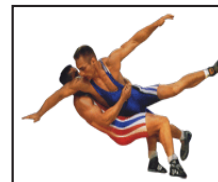

60 kg	TAI, Lixin
66 kg	ZHANG, Gaoquan
74 kg	ZHANG, Ridong
84 kg	PENG, Fei
96 kg	SHI, Wenhao

CROATIA (CRO)

Entraîneur / Coach : VUKELIC, Tomislav

Lutteur(s) / Wrestler(s) :

55 kg	PUSIC, Tin
60 kg	SIMATIC, Kristijan
66 kg	ETLINGER, Dominik

CZECH REPUBLIC (CZE)

Entraîneur / Coach : SVEC, Zdenek

Lutteur(s) / Wrestler(s) :

60 kg	KORISTA, Jakub
66 kg	MORBITZER, Matous
74 kg	VARGA, Oldrich

EGYPT (EGY)

Lutteur(s) / Wrestler(s) :

50 kg	HEMDAN, Mahmoud
55 kg	ABOU HALIMA, Abou Halima Mohamed El Said Ab
60 kg	ADHAM, Ahmed Saleh
66 kg	HAWWASH, Karim
74 kg	ABD ELSALAM SHIBL , Tarek Mohamed
84 kg	MOHAMED, Moataz
96 kg	HAMDY MOSTAFA, Elsaid

FINLAND (FIN)

Entraîneur / Coach : LAPPALAINEN, Juha

HARKANEN, Ari

Lutteur(s) / Wrestler(s) :

55 kg	SHIRMOHAMMADI, Mazyar
60 kg	PITKANEN, Jerry Yesper
66 kg	HIRVI, Lari Tapio



Liste des Engagés par pays / Entry-List By Country

Championnat du Monde - Junior

STYLE GR

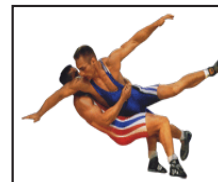

74 kg ALANDER , Jarno Krister
96 kg LAHTI, Tuomas Heikki Juhani

FRANCE (FRA)

Entraîneur / Coach : MAREN DELIS, Juan Luis

Kiné / Medical Staff : RAINA, Antoine

Lutteur(s) / Wrestler(s) :

84 kg DIONG, Samba

GEORGIA (GEO)

Chef de délégation / Team Leader : KAZARASHVILI, Temo

Entraîneur / Coach : ADEISHVILI, Vladimer
SIKAGADZE, Zaza
MATCHUTADZE, Mukhran

Médecin / Medical Staff : SKHIRELI, Manuchar

Lutteur(s) / Wrestler(s) :

120 kg GOGISVANIDZE, Shota
50 kg PUTKARADZE, Bachana
55 kg TSETSKHALADZE, Nika
60 kg TSULUKIDZE, Phiruz
66 kg DAVITAIA, Giorgi
74 kg DZAMASHVILI, Tornike
84 kg KOBLIASHVILI, Roberti
96 kg KAJAIA, Iakobi

GERMANY (GER)

Chef de délégation / Team Leader : SCHERER, Ramona

Entraîneur / Coach : ZAMANDURIDIS, Jannis
BULLMANN, Maik

Médecin / Medical Staff : HUBNER, Reinhard

Kiné / Medical Staff : TRAGESER, Steffen
JENTSCH, Matthias
FRANZ, Axel

Lutteur(s) / Wrestler(s) :

120 kg JOHN, Christian
55 kg FALLACARA, Ibrahim
60 kg GREBENSIKOV, Alexander
66 kg VON TUGGINER, Marc-Antonio



Liste des Engagés par pays / Entry-List By Country

Championnat du Monde - Junior

STYLE GR

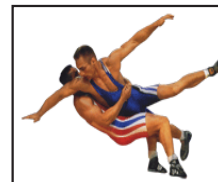

74 kg	EISELE, Pascal
84 kg	KUDLA, Denis Maksymilian
96 kg	OEHLER, Peter

GREECE (GRE)

Chef de délégation / Team Leader : KOLITSOPOULOS, Dimitrios

Entraîneur / Coach : APOSTOLOU, Nikolaos

Lutteur(s) / Wrestler(s) :

120 kg	PAPARAS, Sotirios
66 kg	DEMIRKAN, Panagiotis
84 kg	PAPADOPOULOS, Dimitrios
96 kg	TSEKERIDIS, Dimitros

HONDURAS (HON)

Entraîneur / Coach : TORRES, Humberto

Lutteur(s) / Wrestler(s) :

66 kg	MEJIA SAMBULA, Jefrin Benito
96 kg	MEJIA CASTILLO, Kevin

HUNGARY (HUN)

Entraîneur / Coach : SIKE, Andras

Lutteur(s) / Wrestler(s) :

120 kg	LAM, Balint
50 kg	JUHASZ, Bence
60 kg	LOSONCZI, Otto
66 kg	FEHER, David

INDIA (IND)

Lutteur(s) / Wrestler(s) :

120 kg	MANJEET, Manjeet
50 kg	VIKRAM, Kurade
55 kg	SURENDER, Surender
60 kg	MANISH, Manish
66 kg	SHRI, Bhagwan
74 kg	RAVINDER, Ravinder
84 kg	RAHUL, Rahul



Liste des Engagés par pays / Entry-List By Country

Championnat du Monde - Junior

STYLE GR

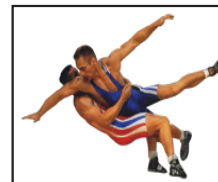

96 kg

SUNIL, Sunil

INDONESIA (INA)

Lutteur(s) / Wrestler(s) :

55 kg

MUHAMMAD, Ismail

IRAN R.I. (IRI)

Chef de délégation / Team Leader :

TABATABAEI, Seyed Moosa

AALI, Parviz

Entraîneur / Coach :

ASHKANI, Ali

RAMEZANI, Majid

CHAMANGOLI, Abdollah

KARIMZADEH, Babak

BAVAFA, Hamid

Médecin / Medical Staff :

SAMADI, Mohammad

TAHERI, Ali

Lutteur(s) / Wrestler(s) :

120 kg

POURSHEIKHALIKAJOUR, Mahdi Asadollah

50 kg

GHOLIKIANI, Ashkan Hasan

55 kg

DISQUALIFIED - MARDANI, Mehrdad Abdmohammad

60 kg

TAHERISARTANG, Ramin Soltanmorad

66 kg

ZEIDVAND, Mehdi Chooli

74 kg

BOUYERI PAYANI, Payam Abdeh Saleh

84 kg

ALIYARIFEIZABADI, Majid Abbas

96 kg

NOROOZI, Saman Abbas

ISRAEL (ISR)

Entraîneur / Coach :

ZIMKIND, Ariel

Lutteur(s) / Wrestler(s) :

50 kg

TSARYUK, Andriy

55 kg

TSARYUK, Ilya

96 kg

GURIELASHVILI, Naor

JAPAN (JPN)

Chef de délégation / Team Leader :

ONO, Kyotaro

SUZUKI, Sakae

Entraîneur / Coach :

TOYOTA, Masatoshi



Liste des Engagés par pays / Entry-List By Country

Championnat du Monde - Junior

STYLE GR

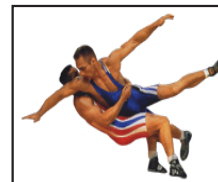

Médecin / Medical Staff :

MATSUMOTO, Shingo

Kiné / Medical Staff :

IMAI, Kazuhiro

OYAMA, Takahiro

Lutteur(s) / Wrestler(s) :

120 kg

SONODA, Arata

50 kg

KAGAWA, Tomohiko

55 kg

OTA, Shinobu

60 kg

MATSUZAWA, Rikiya

66 kg

KANEMITSU, Teruaki

74 kg

NAKAMURA, Takaharu

84 kg

KAGAYA, Yoichiro

96 kg

TANAKA, Tetsuya

KAZAKHSTAN (KAZ)

Chef de délégation / Team Leader :

KYSTAUBAYEV, Manar

Entraîneur / Coach :

MAMBETBAYEV, Baurzhan

DYUSSENOV, Nurym

Médecin / Medical Staff :

TOKHTAGULOV, Zhumash

CHURIKOVA, Klavdiya

Kiné / Medical Staff :

STARODUBOV, Boris

Lutteur(s) / Wrestler(s) :

50 kg

SALTEBAYEV, Askar

55 kg

AITBAYEV, Zhaxylyk

60 kg

DONENBEKOV, Meirbek

66 kg

KANDYBAYEV, Zhanibek

74 kg

KUSTUBAYEV, Azamat

84 kg

TASHMAGAMBETOV, Timur

96 kg

SHAIKENOV, Yerkin

KYRGYZSTAN (KGZ)

Lutteur(s) / Wrestler(s) :

55 kg

MAKSATOV, Mirkhat

60 kg

AMATOV, Urmatbek

66 kg

AIYLCHIEV, Arsen

74 kg

SHIRDAKOV, Samat

84 kg

TOKTOGONOV, Aman

96 kg

TOKTORBAEV, Tynchtyk



Liste des Engagés par pays / Entry-List By Country

Championnat du Monde - Junior

STYLE GR

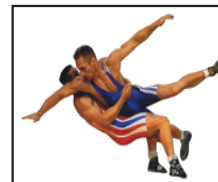

LITHUANIA (LTU)

Chef de délégation / Team Leader : MATAITIS, Vladimiras
VARTANOV, Ruslan

Entraîneur / Coach : ANTOSCENKOV, Oleg

Lutteur(s) / Wrestler(s) :

60 kg	DAGYS, Ramunas
74 kg	SEKUS, Arturas
84 kg	MATUZEVICIUS, Julius
96 kg	LAURINAITIS, Vilius

MEXICO (MEX)

Lutteur(s) / Wrestler(s) :

50 kg	SOTO MACIAS, Ali
-------	------------------

MOLDOVA (MDA)

Chef de délégation / Team Leader : SAVVA, Boris
CUCUL, Mihail
MARTA, Petru

Lutteur(s) / Wrestler(s) :

55 kg	CIOBANU, Victor
60 kg	MAMULAT, Maxim
66 kg	LUCHITA, Ion

MOROCCO (MAR)

Lutteur(s) / Wrestler(s) :

66 kg	SAMORAH, Ahmed
74 kg	LAMGAMMAH, Zakaria

NORWAY (NOR)

Chef de délégation / Team Leader : AANES, Fritz
Entraîneur / Coach : AANES, Fritz

Lutteur(s) / Wrestler(s) :

60 kg	KARLSEN, Petter
66 kg	BURGER, Alexander Eikeskog
96 kg	NIELSEN, Marthin Hamlet



Liste des Engagés par pays / Entry-List By Country

Championnat du Monde - Junior

STYLE GR



POLAND (POL)

Chef de délégation / Team Leader :	ZOLTOWSKI, Robert
Entraîneur / Coach :	ZAWADZKI, Wlodzimierz PRYCKOWSKI, Bartłomiej
Kiné / Medical Staff :	NOWAK, Pawel
Lutteur(s) / Wrestler(s) :	
60 kg	SERKOWSKI , Jakub
66 kg	WANKE, Grzegorz
74 kg	KULYNYCZ, Arkadiusz Marcin
84 kg	FORMELA, Krystian Witold

ROMANIA (ROU)

Chef de délégation / Team Leader :	PARCALABU, Razvan
Entraîneur / Coach :	BOTILA, Mihai
Lutteur(s) / Wrestler(s) :	
50 kg	BOTEZ, Alexandru Vasile
60 kg	ANTON, Alexandru Viorel
66 kg	MOTOI, Cristinel Razvan
74 kg	IANTOC, Alexandru Sorin
84 kg	PIRVAN, Dorin Constantin

RUSSIA (RUS)

Chef de délégation / Team Leader :	POPOV, Isay
Médecin / Medical Staff :	GIREEV, Said
Kiné / Medical Staff :	NAZARICHEV, Sergey
Lutteur(s) / Wrestler(s) :	
120 kg	SHONIYA, Giorgiy
50 kg	LABAZANOV, Artur
55 kg	SARKISSYAN, Arut
60 kg	KABALOEV, Zaur
66 kg	CHUKHALOV, Magomed
74 kg	CHARAEV, Islam
84 kg	TATIEV, Idris
96 kg	EVLOEV, Musa

SLOVAKIA (SVK)

Entraîneur / Coach :	HORVATH, Stefan
-----------------------------	-----------------



Liste des Engagés par pays / Entry-List By Country

Championnat du Monde - Junior

STYLE GR

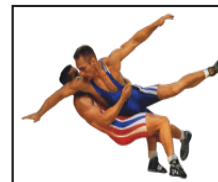

Lutteur(s) / Wrestler(s) :

66 kg	SIMON, Krisztian
96 kg	SOOS , Tamas

SOUTH AFRICA (RSA)

Entraîneur / Coach : COETZEE, Nico

Lutteur(s) / Wrestler(s) :

55 kg	COETZEE, Marco
-------	----------------

SOUTH KOREA (KOR)

Entraîneur / Coach : LEE, Woon-Chai

Lutteur(s) / Wrestler(s) :

120 kg	PARK, Ji-Eung
50 kg	JEON, Hyeok-Jin
55 kg	KIM, Seung-Hak
60 kg	JEONG, Cheol
66 kg	KIM, Do-Hyeong
74 kg	JEON, Neul-pu-leun-san
84 kg	LIM, Sung-Hoon
96 kg	GU, Hak-Bon

SWEDEN (SWE)

Chef de délégation / Team Leader : BESARATI, Fariborz
YAKOB, Jakob

Entraîneur / Coach : NYSTROM, Kenneth

Lutteur(s) / Wrestler(s) :

55 kg	SELDER, Isak Felix
66 kg	BERGSTROM, Per Pontus
74 kg	RAIHA, Marcus Johannes John
96 kg	NYBERG, Mikael Karl Axel

SWITZERLAND (SUI)

Chef de délégation / Team Leader : GISLER, Reto

Entraîneur / Coach : BAUMGARTNER, Mario

Lutteur(s) / Wrestler(s) :

74 kg	DIETSCHKE , Damian
-------	--------------------



Liste des Engagés par pays / Entry-List By Country

Championnat du Monde - Junior

STYLE GR

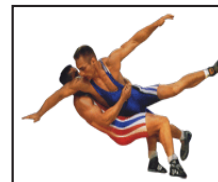

TAIPEI CHINESE (TPE)

Chef de délégation / Team Leader : JANG, Tsong-Rong

Entraîneur / Coach : CHAO, Yin-Lung

Lutteur(s) / Wrestler(s) :

66 kg TSAI , Yu-Chia

TAJIKISTAN (TJK)

Lutteur(s) / Wrestler(s) :

55 kg SHARIFZODA, Azizbeki

66 kg KHSURAV, Obloberdiev

84 kg ALAEV, Manuchekhr

THAILAND (THA)

Lutteur(s) / Wrestler(s) :

120 kg PHATTHANAN, Rodsmali

50 kg MOONMEE, Phongsatorn

55 kg THIRAWAT, Chaiping

60 kg RRAVAN, Ritisak

66 kg APHINAN, Tonkarw

74 kg SIRITHAHAN, Atthaphol

84 kg KANCHALEE, Chinnawet

96 kg YOSPAYAN, Anucha

TURKEY (TUR)

Entraîneur / Coach : OZTURK, Remzi

DEMIRHAN, Bilal

KIZILAY, Ayhan

DUZER, Yusuf

CAGLAR, Tekin

KARAKUS, Huseyin

KARAKOYUN, Serhat

TURGUT, Mehmet

Médecin / Medical Staff : OZTEMUR, Zekeriya

Kiné / Medical Staff : TURKOGLU, Haydar

YURDUSEVEN, Alev

KISACIK, Tamer

Lutteur(s) / Wrestler(s) :



Liste des Engagés par pays / Entry-List By Country

Championnat du Monde - Junior

STYLE GR

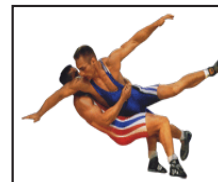

120 kg	ARSLAN, Ali Nail
50 kg	KARATAS, Tolgahan
55 kg	KILIC, Serif
60 kg	BASAR, Enes
66 kg	DEMIRLI, Abdullah
74 kg	KOCASLAN, Ismail
84 kg	GUNGOR, Baris
96 kg	DUNDAR, Taha Yasin

TURKMENISTAN (TKM)

Lutteur(s) / Wrestler(s) :

66 kg	ORASHEV, Arslan
74 kg	YAYLYMOV, Dovran
84 kg	ESENOV, Ylyas

UKRAINE (UKR)

Chef de délégation / Team Leader :

BAZYLIUK, Iaroslav
KAPLUNOVSKIY, Andriy
NOSADCHYY, Eduard

Entraîneur / Coach :

NASIROV, Yashar
ABDULAYEV, Bolat
LOZOVYI, Viktor

Médecin / Medical Staff :

MOSKALENKO, Oleksandr
BARSUKOV, Oleksii

Kiné / Medical Staff :

PARNAK, Andriy

Lutteur(s) / Wrestler(s) :

120 kg	KUCHMII, Mykola
50 kg	SYMONENKO, Vasyl
55 kg	RUDOV, Andrii
60 kg	GAIDUK, Roman
66 kg	PYNKOV, Dmytro
74 kg	KUKHTA, Oleksandr
84 kg	BLYUMIN, Arkadiy
96 kg	VOLOSHANIN, Samir

UNITED STATES (USA)

Chef de délégation / Team Leader :

ROSBOTTOM, Louis

Entraîneur / Coach :

SHELDON, Shawn



Liste des Engagés par pays / Entry-List By Country

Championnat du Monde - Junior

STYLE GR



Médecin / Medical Staff :

ANDERSON, Ike
GROSSMAN, Dave
MONSEAU, AJ

Lutteur(s) / Wrestler(s) :

120 kg	BAKER, Wayne Wyatt
50 kg	VARONA, Isaiah Luis
55 kg	FUENFFINGER, Leslie Michael
60 kg	THIELKE, Jesse David
66 kg	ALVAREZ, Alan Nicolas
74 kg	SPEILLER, Geordan
84 kg	SHERIDAN, Lucas Connor
96 kg	FINAU, Marcus Anthony Lanakila

UZBEKISTAN (UZB)

Entraîneur / Coach :

GARIPOV, Zamir
DAVYDIAN, Nelson

Lutteur(s) / Wrestler(s) :

120 kg	AKBAROV, Sherzod
55 kg	MAHMUDOVI, Ahmadjon
60 kg	ZAYLOBIDINOV, Bobirbek
84 kg	KAMILOV, Ruslan
96 kg	HAKIMOV, Dilshod



Feuille de compétition / Competition Sheet

Championnat du Monde - Junior

STYLE : GR 120 kg



QUALIFICATION			1/8 FINALE			1/4 FINALE			1/2 FINALE			FINALE		
1	ARSLAN Ali Nail (TUR)		1	1	TUR	P1	P2	P3	0	1	0			
2	MEXRALIYEN Zaur (AZE)		2	3	AZE	P1	P2	P3	0	1	1			
3	SONODA Arata (JPN)		3	0	JPN	P1	P2	P3	0	0	0			
4	SHONIYA Giorgiy (RUS)		4	5	RUS	P1	P2	P3	3	0	0			
5	LAM Balint (HUN)		5	3	HUN	P1	P2	P3	1	1	0			
6	JOHN Christian (GER)		6	0	GER	P1	P2	P3	0	0	0			
7	POURSHEIKHALIKAJOUR M. (IRI)		7	0	IRI	P1	P2	P3	0	0	0			
8	METODIEV M. (BUL)		8	3	BUL	P1	P2	P3	1	2	0			
9	GOGISVANIDZE Shota (GEO)		9	5	GEO	P1	P2	P3	4	0	0			
10	PARK Ji-Eung (KOR)		10	0	KOR	P1	P2	P3	0	0	0			
11	AKBAROV Sherzod (UZB)		11	3	UZB	P1	P2	P3	1	1	0			
12	PAPARAS Sotirios (GRE)		12	0	GRE	P1	P2	P3	0	0	0			
13	KUCHMII Mykola (UKR)		13	3	UKR	P1	P2	P3	2	2	4			
14	BAKER Wayne Wyatt (USA)		14	1	USA	P1	P2	P3	0	4	0			
15	MANJEET Manjeet (IND)		15	0	IND	P1	P2	P3	0	0	0			
16	PHATTHANAN R. (THA)	P1	P2	P3	0	0	0							
17	ZHANG Yannan (CHN)	P1	P2	P3	6	0	0							

5 LAM Balint (HUN)

Classement

Cl	Pays	Nom
1	HUN	LAM Balint
2	GEO	GOGISVANIDZE Shota
3	AZE	MEXRALIYEN Zaur
3	CHN	ZHANG Yannan
5	BUL	METODIEV Miloslav Yuriev
5	KOR	PARK Ji-Eung
7	RUS	SHONIYA Giorgiy
8	UZB	AKBAROV Sherzod
9	UKR	KUCHMII Mykola
10	USA	BAKER Wayne Wyatt
11	TUR	ARSLAN Ali Nail
12	GRE	PAPARAS Sotirios
13	JPN	SONODA Arata
13	IRI	POURSHEIKHALIKAJOUR Mahdi Asa
15	GER	JOHN Christian
16	THA	PHATTHANAN Rodsmali
17	IND	MANJEET Manjeet

REPECHAGE

REPECHAGE FINALISTE 1

6	0	GER	P1	P2	P3	0	0	0
8	3	BUL	P1	P2	P3	1	2	0
8	1	BUL	P1	P2	P3	0	1	0
2	3	AZE	P1	P2	P3	1	0	1

2 MEXRALIYEN Zaur (AZE)

Mdaille de Bronze

REPECHAGE FINALISTE 2

10	3	KOR	P1	P2	P3	0	1	1
11	1	UZB	P1	P2	P3	1	1	0
10	0	KOR	P1	P2	P3	0	0	0
17	3	CHN	P1	P2	P3	1	2	0

17 ZHANG Yannan (CHN)

Mdaille de Bronze



Classement

Championnat du Monde - Junior

STYLE : GR 120 kg



1 - Or / Gold



LAM Balint

2 - Argent / Silver



GOGISVANIDZE Shota

3 - Bronze



MEXRALIYEN Zaur



ZHANG Yannan

Classement	Nom - Name	Pays - Country
1	LAM Balint	HUN
2	GOGISVANIDZE Shota	GEO
3	MEXRALIYEN Zaur	AZE
3	ZHANG Yannan	CHN
5	METODIEV M.	BUL
5	PARK Ji-Eung	KOR
7	SHONIYA Giorgiy	RUS
8	AKBAROV Sherzod	UZB
9	KUCHMII Mykola	UKR
10	BAKER Wayne Wyatt	USA
11	ARSLAN Ali Nail	TUR
12	PAPARAS Sotirios	GRE
13	SONODA Arata	JPN
13	POURSHEIKHALIKAJOUR M.	IRI
15	JOHN Christian	GER
16	PHATTHANAN Rodsmali	THA
17	MANJEET Manjeet	IND



Feuille de compétition / Competition Sheet

Championnat du Monde - Junior

STYLE : GR 50 kg



QUALIFICATION		1/8 FINALE		1/4 FINALE		1/2 FINALE		FINALE	
1	FANG Haibin (CHN)	1	3 5	CHN	P1 2	P2 0	P3 3		
2	PUTKARADZE Bachana (GEO)	2	1 4	GEO	P1 0	P2 2	P3 2		
3	SALTEBAYEV Askar (KAZ)	3	0 4	KAZ	P1 0	P2 4	P3 0		
4	SYMONENKO Vasyl (UKR)	4	5 6	UKR	P1 1	P2 5	P3 0		
5	BOTEZ A. (ROU)	5	1 1	ROU	P1 1	P2 0	P3 0		
6	SOTO MACIAS Ali (MEX)	6	3 6	MEX	P1 4	P2 2	P3 0		
7	KAGAWA Tomohiko (JPN)	7	0 0	JPN	P1 0	P2 0	P3 0		
8	LABAZANOV Artur (RUS)	8	3 12	RUS	P1 8	P2 4	P3 0		
9	HEMDAN Mahmoud (EGY)	9	1 3	EGY	P1 3	P2 0	P3 0		
10	TSARYUK Andriy (ISR)	10	3 10	ISR	P1 4	P2 6	P3 0		
11	MKRTCHYAN Rudik (ARM)	11	1 1	ARM	P1 1	P2 0	P3 0		
12	JUHASZ Bence (HUN)	12	3 3	HUN	P1 1	P2 2	P3 0		
13	VIKRAM Kurade (IND)	13	0 0	IND	P1 0	P2 0	P3 0		
14	MOONMEE P. (THA)	14	0 0		P1 0	P2 0	P3 0		
15	KARATAS Tolgahan (TUR)	15	3 9	TUR	P1 2	P2 10	P3 0		
16	GHOLIKIANI A. (IRI)	16	0 0		P1 0	P2 0	P3 0		
17	BAZAROV Murad (AZE)	17	3 5	AZE	P1 4	P2 1	P3 0		
18	JEON Hyeok-Jin (KOR)	18	3 5	KOR	P1 2	P2 3	P3 0		
19	VARONA Isaiah Luis (USA)	19	1 4		P1 2	P2 2	P3 0		

17 BAZAROV Murad (AZE)

Classement

Cl	Pays	Nom
1	AZE	BAZAROV Murad
2	RUS	LABAZANOV Artur
3	MEX	SOTO MACIAS Ali
3	TUR	KARATAS Tolgahan
5	UKR	SYMONENKO Vasyl
5	ISR	TSARYUK Andriy
7	CHN	FANG Haibin
8	IRI	GHOLIKIANI Ashkan Hasan
9	HUN	JUHASZ Bence
10	KOR	JEON Hyeok-Jin
11	GEO	PUTKARADZE Bachana
11	USA	VARONA Isaiah Luis
13	EGY	HEMDAN Mahmoud
14	JPN	KAGAWA Tomohiko
15	ARM	MKRTCHYAN Rudik
16	ROU	BOTEZ Alexandru Vasile
17	KAZ	SALTEBAYEV Askar
18	THA	MOONMEE Phongsatorn
19	IND	VIKRAM Kurade

REPECHAGE

REPECHAGE FINALISTE 1

7	1 2	JPN	P1 2	P2 0	P3 0
6	3 14	MEX	P1 0	P2 4	P3 10
6	3 6	MEX	P1 2	P2 4	P3 0
4	1 1	UKR	P1 1	P2 0	P3 0

6 SOTO MACIAS Ali (MEX)

Mdaille de Bronze

REPECHAGE FINALISTE 2

16	3 5	IRI	P1 4	P2 1	P3 0
18	0 0	KOR	P1 0	P2 0	P3 0
16	1 2	IRI	P1 0	P2 2	P3 0
15	3 9	TUR	P1 1	P2 0	P3 8
15	3 5	TUR	P1 4	P2 1	P3 0
10	0 0	ISR	P1 0	P2 0	P3 0

15 KARATAS Tolgahan (TUR)

Mdaille de Bronze



Classement

Championnat du Monde - Junior

STYLE : GR 50 kg



1 - Or / Gold



BAZAROV Murad

2 - Argent / Silver



LABAZANOV Artur

3 - Bronze



SOTO MACIAS Ali



KARATAS Tolgahan

Classement	Nom - Name	Pays - Country
1	BAZAROV Murad	AZE
2	LABAZANOV Artur	RUS
3	SOTO MACIAS Ali	MEX
3	KARATAS Tolgahan	TUR
5	SYMONENKO Vasyl	UKR
5	TSARYUK Andriy	ISR
7	FANG Haibin	CHN
8	GHOLIKIANI A.	IRI
9	JUHASZ Bence	HUN
10	JEON Hyeok-Jin	KOR
11	PUTKARADZE Bachana	GEO
11	VARONA Isaiah Luis	USA
13	HEMDAN Mahmoud	EGY
14	KAGAWA Tomohiko	JPN
15	MKRTCHYAN Rudik	ARM
16	BOTEZ A.	ROU
17	SALTEBAYEV Askar	KAZ
18	MOONMEE Phongsatorn	THA
19	VIKRAM Kurade	IND



Feuille de compétition / Competition Sheet

Championnat du Monde - Junior

STYLE : GR 55 kg



QUALIFICATION			1/8 FINALE			1/4 FINALE			1/2 FINALE			FINALE		
1	COETZEE Marco (RSA)		1	RSA	P1 P2 P3 0 3 0	2	USA	P1 P2 P3 0 1 0	3	TUR	P1 P2 P3 0 1 0	10	AZE	P1 P2 P3 1 1 0
2	FUENFFINGER L. (USA)		2	USA	P1 P2 P3 6 1 6	3	TUR	P1 P2 P3 7 1 0	10	AZE	P1 P2 P3 1 6 0	17	BUL	P1 P2 P3 1 1 0
3	KILIC Serif (TUR)		3	TUR	P1 P2 P3 7 1 0	3	TUR	P1 P2 P3 4 3 0	10	AZE	P1 P2 P3 1 6 0	28	MDA	P1 P2 P3 0 0 0
4	MUHAMMAD Ismail (INA)		4	INA	P1 P2 P3 1 0 0	7	FIN	P1 P2 P3 0 0 0	10	AZE	P1 P2 P3 1 4 0	28	MDA	P1 P2 P3 2 0 1
5	AITBAYEV Zhaxylyk (KAZ)	P1 P2 P3 6 6 0	5	KAZ	P1 P2 P3 1 1 0	10	AZE	P1 P2 P3 1 6 0	17	BUL	P1 P2 P3 5 0 2	28	MDA	P1 P2 P3 2 0 1
6	THIRAWAT Chaiping (THA)	P1 P2 P3 0 0 0	7	FIN	P1 P2 P3 4 3 0	10	AZE	P1 P2 P3 1 6 0	17	BUL	P1 P2 P3 1 0 1	28	MDA	P1 P2 P3 2 0 1
7	SHIRMOHAMMADI M. (FIN)	P1 P2 P3 4 3 0	7	FIN	P1 P2 P3 1 2 0	10	AZE	P1 P2 P3 1 6 0	17	BUL	P1 P2 P3 1 0 1	28	MDA	P1 P2 P3 2 0 1
8	SELDER Isak Felix (SWE)	P1 P2 P3 2 0 0	10	AZE	P1 P2 P3 1 6 0	10	AZE	P1 P2 P3 1 4 0	17	BUL	P1 P2 P3 1 1 0	28	MDA	P1 P2 P3 2 0 1
9	OTA Shinobu (JPN)	P1 P2 P3 0 0 0	10	AZE	P1 P2 P3 1 6 0	10	AZE	P1 P2 P3 1 4 0	17	BUL	P1 P2 P3 1 1 0	28	MDA	P1 P2 P3 2 0 1
10	AZIZLI Eldaniz (AZE)	P1 P2 P3 1 6 0	10	AZE	P1 P2 P3 1 6 0	10	AZE	P1 P2 P3 1 4 0	17	BUL	P1 P2 P3 1 1 0	28	MDA	P1 P2 P3 2 0 1
11	ABOU HALIMA A. (EGY)	P1 P2 P3 4 3 0	11	EGY	P1 P2 P3 0 0 0	14	IRI	P1 P2 P3 4 1 0	17	BUL	P1 P2 P3 1 1 0	28	MDA	P1 P2 P3 2 0 1
12	ZHAO Gaoyuan (CHN)	P1 P2 P3 2 0 0	14	IRI	P1 P2 P3 4 1 0	14	IRI	P1 P2 P3 0 1 0	17	BUL	P1 P2 P3 1 1 0	28	MDA	P1 P2 P3 2 0 1
13	ASTAPOVICH A. (BLR)	P1 P2 P3 0 3 0	14	IRI	P1 P2 P3 4 1 0	14	IRI	P1 P2 P3 0 1 0	17	BUL	P1 P2 P3 1 1 0	28	MDA	P1 P2 P3 2 0 1
14	DISQUALIFIED - MARDANI M. (IRI)	P1 P2 P3 3 5 0	14	IRI	P1 P2 P3 4 1 0	14	IRI	P1 P2 P3 0 1 0	17	BUL	P1 P2 P3 1 1 0	28	MDA	P1 P2 P3 2 0 1
15	SHARIFZODA A. (TJK)	P1 P2 P3 4 1 0	15	TJK	P1 P2 P3 0 0 0	14	IRI	P1 P2 P3 0 1 0	17	BUL	P1 P2 P3 1 1 0	28	MDA	P1 P2 P3 2 0 1
16	TSARYUK Ilyya (ISR)	P1 P2 P3 0 0 0	15	TJK	P1 P2 P3 0 0 0	14	IRI	P1 P2 P3 0 1 0	17	BUL	P1 P2 P3 1 1 0	28	MDA	P1 P2 P3 2 0 1
17	VICHEV N. (BUL)	P1 P2 P3 2 0 1	17	BUL	P1 P2 P3 5 0 2	14	IRI	P1 P2 P3 0 1 0	17	BUL	P1 P2 P3 1 1 0	28	MDA	P1 P2 P3 2 0 1
18	MAKSATOV Mirkhat (KGZ)	P1 P2 P3 1 2 0	17	BUL	P1 P2 P3 5 0 2	14	IRI	P1 P2 P3 0 1 0	17	BUL	P1 P2 P3 1 1 0	28	MDA	P1 P2 P3 2 0 1
19	MAHMUDOV Ahmadjon (UZB)	P1 P2 P3 1 0 0	17	BUL	P1 P2 P3 5 0 2	14	IRI	P1 P2 P3 0 1 0	17	BUL	P1 P2 P3 1 1 0	28	MDA	P1 P2 P3 2 0 1
20	RUDOV Andrii (UKR)	P1 P2 P3 0 1 3	20	UKR	P1 P2 P3 0 2 0	14	IRI	P1 P2 P3 0 1 0	17	BUL	P1 P2 P3 1 1 0	28	MDA	P1 P2 P3 2 0 1
21	TSETSKHALADZE Nika (GEO)	P1 P2 P3 0 5 0	20	UKR	P1 P2 P3 0 2 0	14	IRI	P1 P2 P3 0 1 0	17	BUL	P1 P2 P3 1 1 0	28	MDA	P1 P2 P3 2 0 1
22	SURENDER Surrender (IND)	P1 P2 P3 4 9 0	22	IND	P1 P2 P3 0 0 0	14	IRI	P1 P2 P3 0 1 0	17	BUL	P1 P2 P3 1 1 0	28	MDA	P1 P2 P3 2 0 1
23	KIM Seung-Hak (KOR)	P1 P2 P3 3 6 0	22	IND	P1 P2 P3 0 0 0	14	IRI	P1 P2 P3 0 1 0	17	BUL	P1 P2 P3 1 1 0	28	MDA	P1 P2 P3 2 0 1
24	PUSIC Tin (CRO)	P1 P2 P3 0 0 0	22	IND	P1 P2 P3 0 0 0	14	IRI	P1 P2 P3 0 1 0	17	BUL	P1 P2 P3 1 1 0	28	MDA	P1 P2 P3 2 0 1
25	SARKISSYAN Arut (RUS)	P1 P2 P3 0 1 0	22	IND	P1 P2 P3 0 0 0	14	IRI	P1 P2 P3 0 1 0	17	BUL	P1 P2 P3 1 1 0	28	MDA	P1 P2 P3 2 0 1
26	GHARIBYAN Gevorg (ARM)	P1 P2 P3 1 5 0	22	IND	P1 P2 P3 0 0 0	14	IRI	P1 P2 P3 0 1 0	17	BUL	P1 P2 P3 1 1 0	28	MDA	P1 P2 P3 2 0 1
27	FALLACARA Ibrahim (GER)	P1 P2 P3 0 0 0	22	IND	P1 P2 P3 0 0 0	14	IRI	P1 P2 P3 0 1 0	17	BUL	P1 P2 P3 1 1 0	28	MDA	P1 P2 P3 2 0 1
28	CIOBANU Victor (MDA)	P1 P2 P3 2 1 0	22	IND	P1 P2 P3 0 0 0	14	IRI	P1 P2 P3 0 1 0	17	BUL	P1 P2 P3 1 1 0	28	MDA	P1 P2 P3 2 0 1

10 AZIZLI Eldaniz (AZE)

Classement

Cl	Pays	Nom
1	AZE	AZIZLI Eldaniz
2	MDA	CIOBANU Victor
3	JPN	OTA Shinobu
3	BUL	VICHEV Nikolay Ivanov
5	KOR	KIM Seung-Hak
5	TUR	KILIC Serif
7	ARM	GHARIBYAN Gevorg
8	FIN	SHIRMOHAMMADI Mazyar
9	KAZ	AITBAYEV Zhaxylyk
10	USA	FUENFFINGER Leslie Michael
11	EGY	ABOU HALIMA Abou Halima Mohamed
12	UKR	RUDOV Andrii
13	IND	SURENDER Surrender
14	TJK	SHARIFZODA Azizbeki
15	GEO	TSETSKHALADZE Nika
16	KGZ	MAKSATOV Mirkhat
17	BLR	ASTAPOVICH Aliaksandr
18	RSA	COETZEE Marco
19	CHN	ZHAO Gaoyuan
19	SWE	SELDER Isak Felix
21	UZB	MAHMUDOV Ahmadjon
22	RUS	SARKISSYAN Arut
23	INA	MUHAMMAD Ismail
23	GER	FALLACARA Ibrahim
25	ISR	TSARYUK Ilyya
26	CRO	PUSIC Tin
27	THA	THIRAWAT Chaiping

REPECHAGE

REPECHAGE FINALISTE 1

9	JPN	P1 P2 P3 4 5 0	9	JPN	P1 P2 P3 2 6 0	9	JPN	P1 P2 P3 2 6 4
11	EGY	P1 P2 P3 2 0 0	7	FIN	P1 P2 P3 0 0 0	3	TUR	P1 P2 P3 4 0 0

9 OTA Shinobu (JPN)

Mdaille de Bronze

REPECHAGE FINALISTE 2

27	GER	P1 P2 P3 1 0 0	26	ARM	P1 P2 P3 3 1 2	23	KOR	P1 P2 P3 5 0 0
26	ARM	P1 P2 P3 2 3 0	23	KOR	P1 P2 P3 2 4 4	17	BUL	P1 P2 P3 0 1 2

17 VICHEV N. (BUL)

Mdaille de Bronze



Classement

Championnat du Monde - Junior

STYLE : GR 55 kg



1 - Or / Gold



AZIZLI Eldaniz

2 - Argent / Silver



CIOBANU Victor

3 - Bronze



OTA Shinobu



VICHEV Nikolay Ivanov

Classement	Nom - Name	Pays - Country
1	AZIZLI Eldaniz	AZE
2	CIOBANU Victor	MDA
3	OTA Shinobu	JPN
3	VICHEV N.	BUL
5	KIM Seung-Hak	KOR
5	KILIC Serif	TUR
7	GHARIBYAN Gevorg	ARM
8	SHIRMOHAMMADI M.	FIN
9	AITBAYEV Zhaxylyk	KAZ
10	FUENFFINGER L.	USA
11	ABOU HALIMA A.	EGY
12	RUDOV Andrii	UKR
13	SURENDER Surrender	IND
14	SHARIFZODA Azizbeki	TJK
15	TSETSKHALADZE Nika	GEO
16	MAKSATOV Mirkhat	KGZ
17	ASTAPOVICH A.	BLR
18	COETZEE Marco	RSA
19	ZHAO Gaoyuan	CHN
19	SELDER Isak Felix	SWE
21	MAHMUDOV Ahmadjon	UZB
22	SARKISSYAN Arut	RUS
23	MUHAMMAD Ismail	INA
23	FALLACARA Ibrahim	GER
25	TSARYUK Illya	ISR
26	PUSIC Tin	CRO
27	THIRAWAT Chaiping	THA



Feuille de compétition / Competition Sheet

Championnat du Monde - Junior

STYLE : GR 60 kg



QUALIFICATION				1/8 FINALE				1/4 FINALE				1/2 FINALE				FINALE									
1		DAGYS Ramunas (LTU)						1	0	0	P1	P2	P3												
2		TAHERISARTANG R. (IRI)						2	3	4	IRI	P1	P2	P3											
3		GREBENSIKOV A. (GER)						3	1	5	GER	P1	P2	P3											
4	1	DZIVACHENKA K. (BLR)	P1	P2	P3			5	3	6	KOR	P1	P2	P3											
	2		0	2	0																				
5	3	JEONG Cheol (KOR)	P1	P2	P3																				
	9		4	5	0																				
6	4	SIMATIC Kristijan (CRO)	P1	P2	P3			6	0	0	CRO	P1	P2	P3											
	13		7	6	0																				
7	0	MARCHL Anton (AUT)	P1	P2	P3			9	3	2	USA	P1	P2	P3											
	0		0	0	0																				
8	0	TAI Lixin (CHN)	P1	P2	P3			9	3	2	USA	P1	P2	P3											
	0		0	0	0																				
9	3	THIELKE J. (USA)	P1	P2	P3			11	3	6	MDA	P1	P2	P3											
	2		1	1	0																				
10	1	ANTON A. (ROU)	P1	P2	P3			11	1	4	MDA	P1	P2	P3											
	1		1	0	0																				
11	3	MAMULAT Maxim (MDA)	P1	P2	P3			12	1	1	IND	P1	P2	P3											
	10		0	4	6																				
12	3	MANISH Manish (IND)	P1	P2	P3			15	3	6	KGZ	P1	P2	P3											
	5		2	3	0																				
13	0	MATSUZAWA Rikiya (JPN)	P1	P2	P3			15	0	0	KGZ	P1	P2	P3											
	0		0	0	0																				
14	1	ZAYLOBIDINOV B. (UZB)	P1	P2	P3			17	1	3	GEO	P1	P2	P3											
	2		1	0	1																				
15	3	AMATOV Urmatbek (KGZ)	P1	P2	P3			18	0	0	EGY	P1	P2	P3											
	6		0	2	4																				
16	0	GAIDUK Roman (UKR)	P1	P2	P3			20	3	4	TUR	P1	P2	P3											
	0		0	0	0																				
17	3	TSULUKIDZE Phiruz (GEO)	P1	P2	P3			20	3	5	TUR	P1	P2	P3											
	2		1	1	0																				
18	3	ADHAM Ahmed Saleh (EGY)	P1	P2	P3			23	3	6	RUS	P1	P2	P3											
	3		2	1	0																				
19	0	KARLSEN Petter (NOR)	P1	P2	P3			23	3	12	RUS	P1	P2	P3											
	0		0	0	0																				
20	3	BASAR Enes (TUR)	P1	P2	P3			24	0	0	AZE	P1	P2	P3											
	2		1	1	0																				
21	0	PITKANEN J. (FIN)	P1	P2	P3			26	0	0	CZE	P1	P2	P3											
	0		0	0	0																				
22	1	DONENBEKOV M. (KAZ)	P1	P2	P3			29	0	0	POL	P1	P2	P3											
	2		2	0	0																				
23	3	KABALOEV Zaur (RUS)	P1	P2	P3			29	3	5	POL	P1	P2	P3											
	4		0	3	1																				
24	3	TAGHIYEV Rovshan (AZE)	P1	P2	P3			29	3	5	POL	P1	P2	P3											
	7		4	0	3																				
25	1	KHACHATRYAN Vazgen (ARM)	P1	P2	P3			29	3	5	POL	P1	P2	P3											
	2		0	2	0																				
26	3	KORISTA Jakub (CZE)	P1	P2	P3			29	3	5	POL	P1	P2	P3											
	4		3	1	0																				
27	0	LOSONCZI Otto (HUN)	P1	P2	P3			29	3	5	POL	P1	P2	P3											
	0		0	0	0																				
28	0	RRAVAN Ritisak (THA)	P1	P2	P3			29	3	5	POL	P1	P2	P3											
	0		0	0	0																				
29	3	SERKOWSKI Jakub (POL)	P1	P2	P3			29	3	5	POL	P1	P2	P3											
	10		5	5	0																				

23 KABALOEV Zaur (RUS)

Classement

Cl	Pays	Nom
1	RUS	KABALOEV Zaur
2	IRI	TAHERISARTANG Ramin Soltanmoradlou
3	TUR	BASAR Enes
3	USA	THIELKE Jesse David
5	LTU	DAGYS Ramunas
5	POL	SERKOWSKI Jakub
7	MDA	MAMULAT Maxim
8	KOR	JEONG Cheol
9	KGZ	AMATOV Urmatbek
10	KAZ	DONENBEKOV Meirbek
11	CRO	SIMATIC Kristijan
12	AZE	TAGHIYEV Rovshan
13	IND	MANISH Manish
14	GEO	TSULUKIDZE Phiruz
15	CZE	KORISTA Jakub
16	EGY	ADHAM Ahmed Saleh
17	GER	GREBENSIKOV Alexander
18	UZB	ZAYLOBIDINOV Bobirbek
19	ARM	KHACHATRYAN Vazgen
20	BLR	DZIVACHENKA Kanstantsin
21	ROU	ANTON Alexandru Viorel
22	CHN	TAI Lixin
22	FIN	PITKANEN Jerry Yesper
22	UKR	GAIDUK Roman
25	NOR	KARLSEN Petter
26	HUN	LOSONCZI Otto
27	JPN	MATSUZAWA Rikiya
28	THA	RRAVAN Ritisak
29	AUT	MARCHL Anton

REPECHAGE

REPECHAGE FINALISTE 1

1	3	3	LTU	P1	P2	P3				1	0	0	LTU	P1	P2	P3			
5	1	1	KOR	P1	P2	P3				9	3	2	USA	P1	P2	P3			

9 THIELKE J. (USA)

Mdaille de Bronze

REPECHAGE FINALISTE 2

22	3	5	KAZ	P1	P2	P3				22	1	4	KAZ	P1	P2	P3			
24	1	1	AZE	P1	P2	P3				29	3	5	POL	P1	P2	P3			

20 BASAR Enes (TUR)

Mdaille de Bronze



Classement

Championnat du Monde - Junior

STYLE : GR 60 kg

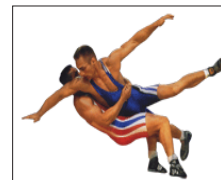

1 - Or / Gold

KABALOEV Zaur

2 - Argent / Silver



TAHERISARTANG Ramin Soltanmorad

3 - Bronze



BASAR Enes



THIELKE Jesse David

<i>Classement</i>	<i>Nom - Name</i>	<i>Pays - Country</i>
1	KABALOEV Zaur	RUS
2	TAHERISARTANG R.	IRI
3	BASAR Enes	TUR
3	THIELKE Jesse David	USA
5	DAGYS Ramunas	LTU
5	SERKOWSKI Jakub	POL
7	MAMULAT Maxim	MDA
8	JEONG Cheol	KOR
9	AMATOV Urmatbek	KGZ
10	DONENBEKOV Meirbek	KAZ
11	SIMATIC Kristijan	CRO
12	TAGHIYEV Rovshan	AZE
13	MANISH Manish	IND
14	TSULUKIDZE Phiruz	GEO
15	KORISTA Jakub	CZE
16	ADHAM Ahmed Saleh	EGY
17	GREBENSIKOV A.	GER
18	ZAYLOBIDINOV B.	UZB
19	KHACHATRYAN Vazgen	ARM
20	DZIVACHENKA K.	BLR
21	ANTON A.	ROU
22	TAI Lixin	CHN
22	PITKANEN J.	FIN
22	GAIDUK Roman	UKR
25	KARLSEN Petter	NOR
26	LOSONCZI Otto	HUN
27	MATSUZAWA Rikiya	JPN
28	RRAVAN Ritisak	THA
29	MARCHL Anton	AUT



Feuille de compétition / Competition Sheet

Championnat du Monde - Junior

STYLE : GR 66 kg



QUALIFICATION				1/16 Finale				1/8 FINALE					
1	3/3	ALVAREZ A. (USA)	P1 P2 P3 1 2 0	1	3/4	ALVAREZ A. (USA)	P1 P2 P3 2 2 0	1	0/0	USA	P1 P2 P3 0 0 0		
	3/3		P1 P2 P3 1 2 0		0/0	MORBITZER Matous (CZE)	P1 P2 P3 0 0 0		6	3/3	HUN	P1 P2 P3 2 0 1	
2	3/3	MORBITZER Matous (CZE)	P1 P2 P3 1 2 0	2	0/0	MORBITZER Matous (CZE)	P1 P2 P3 0 0 0	2	0/0				
	3/3		P1 P2 P3 1 2 0		3	0/0	SHRI Bhagwan (IND)	P1 P2 P3 0 0 0		4	3/4	TJK	P1 P2 P3 3 1 0
3	3/3	SHRI Bhagwan (IND)	P1 P2 P3 1 2 0	3	0/0	SHRI Bhagwan (IND)	P1 P2 P3 0 0 0	3	0/0				
	3/3		P1 P2 P3 1 2 0		4	3/5	KHSURAV O. (TJK)	P1 P2 P3 1 4 0		8	1/2	KGZ	P1 P2 P3 0 2 0
4	3/3	KHSURAV O. (TJK)	P1 P2 P3 1 2 0	4	3/5	KHSURAV O. (TJK)	P1 P2 P3 1 4 0	4	3/5				
	3/3		P1 P2 P3 1 2 0		5	0/0	DEMIRKAN P. (GRE)	P1 P2 P3 0 0 0		10	0/0	IRI	P1 P2 P3 0 0 0
5	3/3	DEMIRKAN P. (GRE)	P1 P2 P3 1 2 0	5	0/0	DEMIRKAN P. (GRE)	P1 P2 P3 0 0 0	5	0/0				
	3/3		P1 P2 P3 1 2 0		6	5/4	FEHER David (HUN)	P1 P2 P3 4 0 0		11	3/3	VON TUGGINER M. (GER)	P1 P2 P3 0 0 0
6	3/3	FEHER David (HUN)	P1 P2 P3 1 2 0	6	5/4	FEHER David (HUN)	P1 P2 P3 4 0 0	6	5/4				
	3/3		P1 P2 P3 1 2 0		7	1/5	MOTOI C. (ROU)	P1 P2 P3 5 0 0		12	3/2	AZE	P1 P2 P3 1 1 0
7	3/3	MOTOI C. (ROU)	P1 P2 P3 1 2 0	7	1/5	MOTOI C. (ROU)	P1 P2 P3 5 0 0	7	1/5				
	3/3		P1 P2 P3 1 2 0		8	3/13	AIYLCHIEV Arsen (KGZ)	P1 P2 P3 4 3 6		13	0/0	SIMON Krisztian (SVK)	P1 P2 P3 0 0 0
8	3/3	AIYLCHIEV Arsen (KGZ)	P1 P2 P3 1 2 0	8	3/13	AIYLCHIEV Arsen (KGZ)	P1 P2 P3 4 3 6	8	3/13				
	3/3		P1 P2 P3 1 2 0		9	0/0	ORASHEV Arslan (TKM)	P1 P2 P3 0 0 0		14	0/2	NOR	P1 P2 P3 2 0 0
9	3/3	ORASHEV Arslan (TKM)	P1 P2 P3 1 2 0	9	0/0	ORASHEV Arslan (TKM)	P1 P2 P3 0 0 0	9	0/0				
	3/3		P1 P2 P3 1 2 0		10	3/5	ZEIDVAND M. (IRI)	P1 P2 P3 3 2 0		15	5/7	EGY	P1 P2 P3 3 4 0
10	3/3	ZEIDVAND M. (IRI)	P1 P2 P3 1 2 0	10	3/5	ZEIDVAND M. (IRI)	P1 P2 P3 3 2 0	10	3/5				
	3/3		P1 P2 P3 1 2 0		11	0/0	VON TUGGINER M. (GER)	P1 P2 P3 0 0 0		16	1/2	TSAI Yu-Chia (TPE)	P1 P2 P3 0 2 0
11	3/3	VON TUGGINER M. (GER)	P1 P2 P3 1 2 0	11	0/0	VON TUGGINER M. (GER)	P1 P2 P3 0 0 0	11	0/0				
	3/3		P1 P2 P3 1 2 0		12	3/2	ALIYEV Ceyxhun (AZE)	P1 P2 P3 1 1 0		17	1/1	BOUDJEMLINE Akrem (ALG)	P1 P2 P3 1 0 0
12	3/3	ALIYEV Ceyxhun (AZE)	P1 P2 P3 1 2 0	12	3/2	ALIYEV Ceyxhun (AZE)	P1 P2 P3 1 1 0	12	3/2				
	3/3		P1 P2 P3 1 2 0		13	0/0	SIMON Krisztian (SVK)	P1 P2 P3 0 0 0		18	5/4	KAZ	P1 P2 P3 0 4 0
13	3/3	SIMON Krisztian (SVK)	P1 P2 P3 1 2 0	13	0/0	SIMON Krisztian (SVK)	P1 P2 P3 0 0 0	13	0/0				
	3/3		P1 P2 P3 1 2 0		14	3/5	BURGER A. (NOR)	P1 P2 P3 1 4 0		19	3/3	DEMIRLI Abdullah (TUR)	P1 P2 P3 2 1 0
14	3/3	BURGER A. (NOR)	P1 P2 P3 1 2 0	14	3/5	BURGER A. (NOR)	P1 P2 P3 1 4 0	14	3/5				
	3/3		P1 P2 P3 1 2 0		15	3/5	HAWWASH Karim (EGY)	P1 P2 P3 3 0 2		20	0/0	KIM Do-Hyeong (KOR)	P1 P2 P3 0 0 0
15	3/3	HAWWASH Karim (EGY)	P1 P2 P3 1 2 0	15	3/5	HAWWASH Karim (EGY)	P1 P2 P3 3 0 2	15	3/5				
	3/3		P1 P2 P3 1 2 0		16	1/2	TSAI Yu-Chia (TPE)	P1 P2 P3 0 2 0		21	0/0	BERGSTROM P. (SWE)	P1 P2 P3 0 0 0
16	3/3	TSAI Yu-Chia (TPE)	P1 P2 P3 1 2 0	16	1/2	TSAI Yu-Chia (TPE)	P1 P2 P3 0 2 0	16	1/2				
	3/3		P1 P2 P3 1 2 0		17	1/1	BOUDJEMLINE Akrem (ALG)	P1 P2 P3 1 0 0		22	3/3	CRO	P1 P2 P3 2 1 0
17	3/3	BOUDJEMLINE Akrem (ALG)	P1 P2 P3 1 2 0	17	1/1	BOUDJEMLINE Akrem (ALG)	P1 P2 P3 1 0 0	17	1/1				
	3/3		P1 P2 P3 1 2 0		18	3/10	KANDYBAYEV Z. (KAZ)	P1 P2 P3 4 6 0		23	0/0	GEO	P1 P2 P3 0 0 0
18	3/3	KANDYBAYEV Z. (KAZ)	P1 P2 P3 1 2 0	18	3/10	KANDYBAYEV Z. (KAZ)	P1 P2 P3 4 6 0	18	3/10				
	3/3		P1 P2 P3 1 2 0		19	3/3	DEMIRLI Abdullah (TUR)	P1 P2 P3 2 1 0		24	0/0	STEIGL Stefan (AUT)	P1 P2 P3 0 0 0
19	3/3	DEMIRLI Abdullah (TUR)	P1 P2 P3 1 2 0	19	3/3	DEMIRLI Abdullah (TUR)	P1 P2 P3 2 1 0	19	3/3				
	3/3		P1 P2 P3 1 2 0		20	0/0	KIM Do-Hyeong (KOR)	P1 P2 P3 0 0 0		25	4/13	LUCHITA Ion (MDA)	P1 P2 P3 7 6 0
20	3/3	KIM Do-Hyeong (KOR)	P1 P2 P3 1 2 0	20	0/0	KIM Do-Hyeong (KOR)	P1 P2 P3 0 0 0	20	0/0				
	3/3		P1 P2 P3 1 2 0		21	0/0	BERGSTROM P. (SWE)	P1 P2 P3 0 0 0		26	5/10	MDA	P1 P2 P3 6 4 0
21	3/3	BERGSTROM P. (SWE)	P1 P2 P3 1 2 0	21	0/0	BERGSTROM P. (SWE)	P1 P2 P3 0 0 0	21	0/0				
	3/3		P1 P2 P3 1 2 0		22	3/2	ETLINGER Dominik (CRO)	P1 P2 P3 1 1 0		27	0/0	POL	P1 P2 P3 0 0 0
22	3/3	ETLINGER Dominik (CRO)	P1 P2 P3 1 2 0	22	3/2	ETLINGER Dominik (CRO)	P1 P2 P3 1 1 0	22	3/2				
	3/3		P1 P2 P3 1 2 0		23	3/2	DAVITAIA Giorgi (GEO)	P1 P2 P3 1 1 0		28	0/0	SAMORAH Ahmed (MAR)	P1 P2 P3 0 0 0
23	3/3	DAVITAIA Giorgi (GEO)	P1 P2 P3 1 2 0	23	3/2	DAVITAIA Giorgi (GEO)	P1 P2 P3 1 1 0	23	3/2				
	3/3		P1 P2 P3 1 2 0		24	0/0	STEIGL Stefan (AUT)	P1 P2 P3 0 0 0		29	5/9	PYNKOV Dmytro (UKR)	P1 P2 P3 6 3 0
24	3/3	STEIGL Stefan (AUT)	P1 P2 P3 1 2 0	24	0/0	STEIGL Stefan (AUT)	P1 P2 P3 0 0 0	24	0/0				
	3/3		P1 P2 P3 1 2 0		25	4/13	LUCHITA Ion (MDA)	P1 P2 P3 7 6 0		30	0/0	KANEMITSU Teruaki (JPN)	P1 P2 P3 0 0 0
25	3/3	LUCHITA Ion (MDA)	P1 P2 P3 1 2 0	25	4/13	LUCHITA Ion (MDA)	P1 P2 P3 7 6 0	25	4/13				
	3/3		P1 P2 P3 1 2 0		26	0/0	APHINAN Tonkarw (THA)	P1 P2 P3 0 0 0		31	3/5	ZHANG Gaoquan (CHN)	P1 P2 P3 2 3 0
26	3/3	APHINAN Tonkarw (THA)	P1 P2 P3 1 2 0	26	0/0	APHINAN Tonkarw (THA)	P1 P2 P3 0 0 0	26	0/0				
	3/3		P1 P2 P3 1 2 0		27	3/2	WANKE Grzegorz (POL)	P1 P2 P3 1 1 0		32	0/1	HIRVI Lari Tapio (FIN)	P1 P2 P3 1 0 0
27	3/3	WANKE Grzegorz (POL)	P1 P2 P3 1 2 0	27	3/2	WANKE Grzegorz (POL)	P1 P2 P3 1 1 0	27	3/2				
	3/3		P1 P2 P3 1 2 0		28	0/0	SAMORAH Ahmed (MAR)	P1 P2 P3 0 0 0		33	0/0	MEJIA SAMBULA J. (HON)	P1 P2 P3 2 1 0
28	3/3	SAMORAH Ahmed (MAR)	P1 P2 P3 1 2 0	28	0/0	SAMORAH Ahmed (MAR)	P1 P2 P3 0 0 0	28	0/0				
	3/3		P1 P2 P3 1 2 0		29	1/2	PYNKOV Dmytro (UKR)	P1 P2 P3 0 2 0		34	0/0	YELAK Aliaksei (BLR)	P1 P2 P3 0 0 0
29	5/9	PYNKOV Dmytro (UKR)	P1 P2 P3 6 3 0	29	1/2	PYNKOV Dmytro (UKR)	P1 P2 P3 0 2 0	29	1/2				
	3/3		P1 P2 P3 1 2 0		30	0/0	KANEMITSU Teruaki (JPN)	P1 P2 P3 0 0 0		35	1/4	ARSHAKYAN Hayk (ARM)	P1 P2 P3 0 4 0
30	0/0	KANEMITSU Teruaki (JPN)	P1 P2 P3 0 0 0	30	0/0	KANEMITSU Teruaki (JPN)	P1 P2 P3 0 0 0	30	0/0				
	3/3		P1 P2 P3 1 2 0		31	3/5	ZHANG Gaoquan (CHN)	P1 P2 P3 2 3 0		36	3/3	RUS	P1 P2 P3 3 5 0
31	3/5	ZHANG Gaoquan (CHN)	P1 P2 P3 0 1 4	31	3/5	ZHANG Gaoquan (CHN)	P1 P2 P3 2 3 0	31	3/5				
	3/3		P1 P2 P3 1 2 0		32	0/1	HIRVI Lari Tapio (FIN)	P1 P2 P3 1 0 0		36	3/3	CHUKHALOV Magomed (RUS)	P1 P2 P3 1 2 0
32	0/1	HIRVI Lari Tapio (FIN)	P1 P2 P3 1 0 0	32	0/1	HIRVI Lari Tapio (FIN)	P1 P2 P3 1 0 0	32	0/1				
	3/3		P1 P2 P3 1 2 0		33	0/0	MEJIA SAMBULA J. (HON)	P1 P2 P3 0 0 0					
33	3/3	MEJIA SAMBULA J. (HON)	P1 P2 P3 2 1 0	33	0/0	MEJIA SAMBULA J. (HON)	P1 P2 P3 0 0 0	33	0/0				
	3/3		P1 P2 P3 1 2 0		34	0/0	YELAK Aliaksei (BLR)	P1 P2 P3 0 0 0					
34	0/0	YELAK Aliaksei (BLR)	P1 P2 P3 0 0 0	34	0/0	YELAK Aliaksei (BLR)	P1 P2 P3 0 0 0	34	0/0				
	3/3		P1 P2 P3 1 2 0		35	1/4	ARSHAKYAN Hayk (ARM)	P1 P2 P3 0 4 0					
35	1/4	ARSHAKYAN Hayk (ARM)	P1 P2 P3 0 4 0	35	1/4	ARSHAKYAN Hayk (ARM)	P1 P2 P3 0 4 0	35	1/4				
	3/3		P1 P2 P3 1 2 0		36	3/3	CHUKHALOV Magomed (RUS)	P1 P2 P3 1 2 0					
36	3/3	CHUKHALOV Magomed (RUS)	P1 P2 P3 1 2 0	36	3/3	CHUKHALOV Magomed (RUS)	P1 P2 P3 1 2 0	36	3/3				



Feuille de compétition / Competition Sheet

Championnat du Monde - Junior

STYLE : GR 66 kg



Classement

Cl	Pays	Nom
1	AZE	ALIYEV Ceyxhun
2	RUS	CHUKHALOV Magomed
3	IRI	ZEIDVAND Mehdi Chooli
3	CRO	ETLINGER Dominik
5	HUN	FEHER David
5	MDA	LUCHITA Ion
7	KAZ	KANDYBAYEV Zhanibek
8	EGY	HAWWASH Karim
9	CHN	ZHANG Gaoquan
10	HON	MEJIA SAMBULA Jefrin Benito
11	TJK	KHSURAV Obloberdiev
12	UKR	PYNKOV Dmytro
13	KGZ	AIYLCHIEV Arsen
14	NOR	BURGER Alexander Eikeskog
15	USA	ALVAREZ Alan Nicolas
15	TUR	DEMIRLI Abdullah
17	GEO	DAVITAIA Giorgi
18	POL	WANKE Grzegorz
19	ROU	MOTOI Cristinel Razvan
20	ARM	ARSHAKYAN Hayk

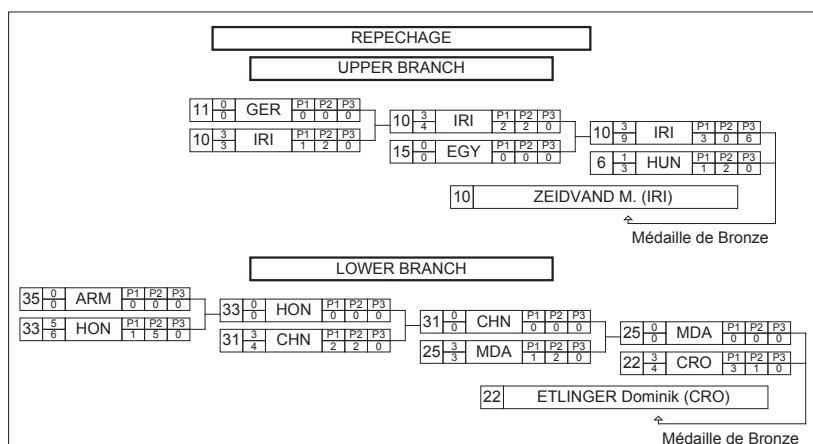



Classement

Championnat du Monde - Junior

STYLE : GR 66 kg



1 - Or / Gold



ALIYEV Ceyxhun

2 - Argent / Silver



CHUKHALOV Magomed

3 - Bronze



ZEIDVAND Mehdi Chooli



ETLINGER Dominik

Classement	Nom - Name	Pays - Country
1	ALIYEV Ceyxhun	AZE
2	CHUKHALOV Magomed	RUS
3	ZEIDVAND M.	IRI
3	ETLINGER Dominik	CRO
5	FEHER David	HUN
5	LUCHITA Ion	MDA
7	KANDYBAYEV Zhanibek	KAZ
8	HAWWASH Karim	EGY
9	ZHANG Gaoquan	CHN
10	MEJIA SAMBULA J.	HON
11	KHSURAV Obloberdiev	TJK
12	PYNKOV Dmytro	UKR
13	AIYLCHIEV Arsen	KGZ
14	BURGER A.	NOR
15	ALVAREZ A.	USA
15	DEMIRLI Abdullah	TUR
17	DAVITAIA Giorgi	GEO
18	WANKE Grzegorz	POL
19	MOTOI C.	ROU
20	ARSHAKYAN Hayk	ARM
21	TSAI Yu-Chia	TPE
22	BOUDJEMLINE Akrem	ALG
23	HIRVI Lari Tapio	FIN
24	STEIGL Stefan	AUT
24	BERGSTROM P.	SWE
24	SAMORAH Ahmed	MAR
27	YELAK Aliaksei	BLR
27	KIM Do-Hyeong	KOR
29	DEMIRKAN Panagiotis	GRE
29	MORBITZER Matous	CZE



Classement

Championnat du Monde - Junior

STYLE : GR 66 kg

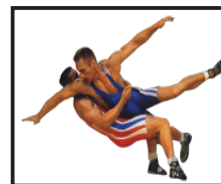

<i>Classement</i>	<i>Nom - Name</i>	<i>Pays - Country</i>
31	ORASHEV Arslan	TKM
31	SHRI Bhagwan	IND
31	SIMON Krisztian	SVK
31	VON TUGGINER M.	GER
35	KANEMITSU Teruaki	JPN
36	APHINAN Tonkarw	THA



Feuille de compétition / Competition Sheet

Championnat du Monde - Junior

STYLE : GR 74 kg



QUALIFICATION				1/8 FINALE				1/4 FINALE				1/2 FINALE				FINALE																	
1		KUSTUBAYEV Azamat (KAZ)						1	4	KAZ	P1	P2	P3																				
									12		6	6	0																				
2		SIRITHAHAN A. (THA)						2	0	THA	P1	P2	P3																				
									0		0	0	0																				
3		RAIHA M. (SWE)						3	0	SWE	P1	P2	P3																				
									0		0	0	0																				
4	3	SHIRDAKOV Samat (KGZ)	P1	P2	P3			4	3	KGZ	P1	P2	P3																				
	5		3	0	2				2		1	1	0																				
5	1	ZHANG Ridong (CHN)	P1	P2	P3			4	2	KGZ	P1	P2	P3																				
	1		0	1	0				1		1	0	0																				
6	0	NAKAMURA Takaharu (JPN)	P1	P2	P3			7	3	BLR	P1	P2	P3																				
	0		0	0	0				2		1	0	1																				
7	3	KILOU Kazbek (BLR)	P1	P2	P3			7	2	BLR	P1	P2	P3																				
	8		1	7	0				3		1	1	0																				
8	0	VARGA Oldrich (CZE)	P1	P2	P3			9	1	IRI	P1	P2	P3																				
	0		0	0	0				1		0	1	0																				
9	3	BOUYERI PAYANI P. (IRI)	P1	P2	P3			9	1	IRI	P1	P2	P3																				
	5		2	3	0				1		0	1	0																				
10	1	CHARAEV Islam (RUS)	P1	P2	P3			11	5	USA	P1	P2	P3																				
	3		1	1	1				6		0	1	5																				
11	3	SPEILLER Geordan (USA)	P1	P2	P3			11	6	USA	P1	P2	P3																				
	5		4	0	1				0		0	0	0																				
12	0	SEKUS Arturas (LTU)	P1	P2	P3			13	0	TKM	P1	P2	P3																				
	0		0	0	0				2		1	1	0																				
13	3	YAYLYMOV Dovran (TKM)	P1	P2	P3			13	2	TKM	P1	P2	P3																				
	2		1	1	0				0		1	1	0																				
14	3	DZAMASHVILI T. (GEO)	P1	P2	P3			14	3	GEO	P1	P2	P3																				
	2		1	1	0				3		2	1	0																				
15	0	DIETSCHKE Damian (SUI)	P1	P2	P3			16	0	UKR	P1	P2	P3																				
	0		0	0	0				0		0	0	0																				
16	3	KUKHTA Oleksandr (UKR)	P1	P2	P3			18	3	ARM	P1	P2	P3																				
	4		1	3	0				4		2	2	0																				
17	0	LAMGAMMAH Zakaria (MAR)	P1	P2	P3			18	0	ARM	P1	P2	P3																				
	0		0	0	0				0		0	0	0																				
18	3	CHALYAN Karapet (ARM)	P1	P2	P3			21	0	IND	P1	P2	P3																				
	8		7	1	0				0		0	0	0																				
19	0	JEON N. (KOR)	P1	P2	P3			22	3	TUR	P1	P2	P3																				
	0		0	0	0				3		0	1	2																				
20	0	WAGNER Michael (AUT)	P1	P2	P3			22	0	TUR	P1	P2	P3																				
	0		0	0	0				0		0	0	0																				
21	3	RAVINDER Ravinder (IND)	P1	P2	P3			27	1	AZE	P1	P2	P3																				
	2		1	1	0				2		2	0	0																				
22	3	KOCASLAN Ismail (TUR)	P1	P2	P3			27	0	ROU	P1	P2	P3																				
	2		1	1	0				0		0	0	0																				
23	0	OUAKALI Abdelkrim (ALG)	P1	P2	P3			28	0	ROU	P1	P2	P3																				
	0		0	0	0				0		0	0	0																				
24	3	ABD ELSALAM SHIBL T. (EGY)	P1	P2	P3			28	1	FIN	P1	P2	P3																				
	6		3	3	0				1		0	1	0																				
25	1	KULYNYCZ A. (POL)	P1	P2	P3			29	1	FIN	P1	P2	P3																				
	2		0	2	0				1		0	1	0																				
26	1	EISELE Pascal (GER)	P1	P2	P3				1		0	1	0																				
	3		2	1	0				0		0	0	0																				
27	3	ERTUGANOV Shamil (AZE)	P1	P2	P3				0		0	0	0																				
	3		2	0	1				0		0	0	0																				

7 KILOU Kazbek (BLR)

Classement

Cl	Pays	Nom
1	BLR	KILOU Kazbek
2	GEO	DZAMASHVILI Tornike
3	ARM	CHALYAN Karapet
3	IRI	BOUYERI PAYANI Payam Abdeh Sale
5	KAZ	KUSTUBAYEV Azamat
5	TUR	KOCASLAN Ismail
7	USA	SPEILLER Geordan
8	KGZ	SHIRDAKOV Samat
9	AZE	ERTUGANOV Shamil
10	UKR	KUKHTA Oleksandr
11	EGY	ABD ELSALAM SHIBL Tarek Moham
12	TKM	YAYLYMOV Dovran
13	ROU	IANTOC Alexandru Sorin
14	IND	RAVINDER Ravinder
15	GER	EISELE Pascal
16	RUS	CHARAEV Islam
17	POL	KULYNYCZ Arkadiusz Marcin
18	FIN	ALANDER Jarno Krister
19	CHN	ZHANG Ridong
20	JPN	NAKAMURA Takaharu
21	ALG	OUAKALI Abdelkrim
21	AUT	WAGNER Michael
21	LTU	SEKUS Arturas
21	SWE	RAIHA Marcus Johannes John
25	MAR	LAMGAMMAH Zakaria
26	CZE	VARGA Oldrich
27	SUI	DIETSCHKE Damian
28	KOR	JEON Neul-pu-leun-san
29	THA	SIRITHAHAN Atthaphol

REPECHAGE

REPECHAGE FINALISTE 1

6	0	JPN	P1	P2	P3			9	3	IRI	P1	P2	P3		
	3		3	0	0				7		6	1	0		
9	5	IRI	P1	P2	P3			9	4	IRI	P1	P2	P3		
	7		0	4	3				0		0	1	3		
								11	0	USA	P1	P2	P3		
									0		0	0	0		

9 BOUYERI PAYANI P. (IRI)

Mdaille de Bronze

REPECHAGE FINALISTE 2

15	0	SUI	P1	P2	P3			16	0	UKR	P1	P2	P3		
	0		0	0	0				0		0	0	0		
16	3	UKR	P1	P2	P3			18	3	ARM	P1	P2	P3		
	4		1	3	0				2		1	1	0		
								22	0	TUR	P1	P2	P3		
									0		0	0	0		

18 CHALYAN Karapet (ARM)

Mdaille de Bronze



Classement

Championnat du Monde - Junior

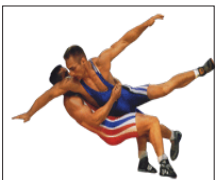

STYLE : GR 74 kg

1 - Or / Gold



KILOU Kazbek

2 - Argent / Silver



DZAMASHVILI Tornike

3 - Bronze



CHALYAN Karapet BOUYERI PAYANI Payam Abdeh Saleh

Classement	Nom - Name	Pays - Country
1	KILOU Kazbek	BLR
2	DZAMASHVILI Tornike	GEO
3	CHALYAN Karapet	ARM
3	BOUYERI PAYANI P.	IRI
5	KUSTUBAYEV Azamat	KAZ
5	KOCASLAN Ismail	TUR
7	SPEILLER Geordan	USA
8	SHIRDAKOV Samat	KGZ
9	ERTUGANOV Shamil	AZE
10	KUKHTA Oleksandr	UKR
11	ABD ELSALAM SHIBL T.	EGY
12	YAYLYMOV Dovran	TKM
13	IANTOC A.	ROU
14	RAVINDER Ravinder	IND
15	EISELE Pascal	GER
16	CHARAEV Islam	RUS
17	KULYNYCZ A.	POL
18	ALANDER J.	FIN
19	ZHANG Ridong	CHN
20	NAKAMURA Takaharu	JPN
21	OUAKALI Abdelkrim	ALG
21	WAGNER Michael	AUT
21	SEKUS Arturas	LTU
21	RAIHA M.	SWE
25	LAMGAMMAH Zakaria	MAR
26	VARGA Oldrich	CZE
27	DIETSCHE Damian	SUI
28	JEON N.	KOR
29	SIRITHAHAN A.	THA



Feuille de compétition / Competition Sheet

Championnat du Monde - Junior

STYLE : GR 84 kg



QUALIFICATION				1/8 FINALE				1/4 FINALE				1/2 FINALE				FINALE																									
1		SHERIDAN L. (USA)						1	5	USA	P1	P2	P3																												
									6		0	2	4																												
2		ALIYEV Fuad (AZE)						2	0	AZE	P1	P2	P3																												
									1		1	0	0																												
3		GUNGOR Baris (TUR)						3	5	TUR	P1	P2	P3																												
									5		5	0	0																												
4		ESENOV Ylyas (TKM)						4	0	TKM	P1	P2	P3																												
									0		0	0	0																												
5		PAPADOPOULOS D. (GRE)						5	0	GRE	P1	P2	P3																												
									0		0	0	0																												
6	0	MOHAMED Moataz (EGY)	P1	P2	P3			7	3	CHN	P1	P2	P3																												
	0		0	0	0				3		1	2	0																												
7	3	PENG Fei (CHN)	P1	P2	P3			8	3	GEO	P1	P2	P3																												
	2		1	1	0				2		1	1	0																												
8	3	KOBLIASHVILI R. (GEO)	P1	P2	P3			8	1	GEO	P1	P2	P3																												
	2		0	1	1				2		1	1	0																												
9	1	TOKTOGONOV Aman (KGZ)	P1	P2	P3			11	0	BLR	P1	P2	P3																												
	1		1	0	0				0		0	0	0																												
10	0	KUDLA D. (GER)	P1	P2	P3			13	0	FRA	P1	P2	P3																												
	0		0	0	0				0		0	0	0																												
11	3	HAHNIDZE Hoha (BLR)	P1	P2	P3			14	3	UKR	P1	P2	P3																												
	3		1	2	0				3		0	1	2																												
12	1	GASTL Daniel (AUT)	P1	P2	P3			14	3	UKR	P1	P2	P3																												
	4		0	3	1				3		1	2	0																												
13	3	DIONG Samba (FRA)	P1	P2	P3			17	0	POL	P1	P2	P3																												
	5		2	1	2				0		0	0	0																												
14	3	BLYUMIN Arkadiy (UKR)	P1	P2	P3			18	1	LTU	P1	P2	P3																												
	5		4	1	0				4		3	0	1																												
15	0	LIM Sung-Hoon (KOR)	P1	P2	P3			18	3	LTU	P1	P2	P3																												
	0		0	0	0				3		1	2	0																												
16	1	ALIYARIFEIZABADI M. (IRI)	P1	P2	P3			20	1	JPN	P1	P2	P3																												
	1		0	1	0				1		0	1	0																												
17	3	FORMELA K. (POL)	P1	P2	P3			22	3	RUS	P1	P2	P3																												
	3		1	0	2				5		4	0	1																												
18	3	MATUZEVICIUS J. (LTU)	P1	P2	P3			22	1	RUS	P1	P2	P3																												
	3		0	1	2				2		1	1	0																												
19	0	TASHMAGAMBETOV T. (KAZ)	P1	P2	P3			24	0	ARM	P1	P2	P3																												
	4		4	0	0				0		0	0	0																												
20	3	KAGAYA Yoichiro (JPN)	P1	P2	P3			24	3	ROU	P1	P2	P3																												
	7		4	3	0				3		1	2	0																												
21	0	ALAEV Manuchekhr (TJK)	P1	P2	P3			27	1	ROU	P1	P2	P3																												
	0		0	0	0				2		0	2	0																												
22	3	TATIEV Idris (RUS)	P1	P2	P3																																				
	2		0	1	1																																				
23	1	KAMILOV Ruslan (UZB)	P1	P2	P3																																				
	1		1	0	0																																				
24	3	PETROSYAN Varos (ARM)	P1	P2	P3																																				
	9		2	7	0																																				
25	0	RAHUL Rahul (IND)	P1	P2	P3																																				
	0		0	0	0																																				
26	0	KANCHALEE C. (THA)	P1	P2	P3																																				
	0		0	0	0																																				
27	5	PIRVAN D. (ROU)	P1	P2	P3																																				
	11		2	9	0																																				

3 GUNGOR Baris (TUR)

Classement

Cl	Pays	Nom
1	TUR	GUNGOR Baris
2	UKR	BLYUMIN Arkadiy
3	FRA	DIONG Samba
3	CHN	PENG Fei
5	RUS	TATIEV Idris
5	TKM	ESENOV Ylyas
7	ROU	PIRVAN Dorin Constantin
8	LTU	MATUZEVICIUS Julius
9	GEO	KOBLIASHVILI Roberti
10	USA	SHERIDAN Lucas Connor
11	JPN	KAGAYA Yoichiro
12	ARM	PETROSYAN Varos
13	BLR	HAHNIDZE Hoha
14	POL	FORMELA Krystian Witold
15	AUT	GASTL Daniel
16	KGZ	TOKTOGONOV Aman
16	UZB	KAMILOV Ruslan
18	IRI	ALIYARIFEIZABADI Majid Abbas
19	KAZ	TASHMAGAMBETOV Timur
20	AZE	ALIYEV Fuad
21	EGY	MOHAMED Moataz
22	GER	KUDLA Denis Maksymilian
22	GRE	PAPADOPOULOS Dimitrios
24	TJK	ALAEV Manuchekhr
25	KOR	LIM Sung-Hoon
26	IND	RAHUL Rahul
27	THA	KANCHALEE Chinnawet

REPECHAGE

REPECHAGE FINALISTE 1

4	3	TKM	P1	P2	P3			4	1	TKM	P1	P2	P3		
	3		2	1	0				2		1	0	1		



Classement

Championnat du Monde - Junior

STYLE : GR 84 kg



1 - Or / Gold



GUNGOR Baris

2 - Argent / Silver



BLYUMIN Arkadiy

3 - Bronze



DIONG Samba



PENG Fei

Classement	Nom - Name	Pays - Country
1	GUNGOR Baris	TUR
2	BLYUMIN Arkadiy	UKR
3	DIONG Samba	FRA
3	PENG Fei	CHN
5	TATIEV Idris	RUS
5	ESENOV Ylyas	TKM
7	PIRVAN D.	ROU
8	MATUZEVICIUS Julius	LTU
9	KOBLIASHVILI R.	GEO
10	SHERIDAN L.	USA
11	KAGAYA Yoichiro	JPN
12	PETROSYAN Varos	ARM
13	HAHNIDZE Hoha	BLR
14	FORMELA K.	POL
15	GASTL Daniel	AUT
16	TOKTOGONOV Aman	KGZ
16	KAMILOV Ruslan	UZB
18	ALIYARIFEIZABADI M.	IRI
19	TASHMAGAMBETOV T.	KAZ
20	ALIYEV Fuad	AZE
21	MOHAMED Moataz	EGY
22	KUDLA D.	GER
22	PAPADOPOULOS D.	GRE
24	ALAEV Manuchekhr	TJK
25	LIM Sung-Hoon	KOR
26	RAHUL Rahul	IND
27	KANCHALEE Chinnawet	THA



Feuille de compétition / Competition Sheet

Championnat du Monde - Junior

STYLE : GR 96 kg



QUALIFICATION				1/8 FINALE				1/4 FINALE				1/2 FINALE				FINALE									
1		SUNIL Sunil (IND)						1	0	IND	P1	P2	P3												
									0		0	0	0												
2		ABDULLAYEV Abas (AZE)						2	3	AZE	P1	P2	P3												
									7		6	1	0												
3		LAURINAITIS Vilius (LTU)						3	5	LTU	P1	P2	P3												
									11		6	5	0												
4		NYBERG M. (SWE)						4	0	SWE	P1	P2	P3												
									0		0	0	0												
5		LAHTI T. (FIN)						5	5	FIN	P1	P2	P3												
									6		0	1	5												
6		TSEKERIDIS D. (GRE)						6	0	GRE	P1	P2	P3												
									2		1	1	0												
7	0	GU Hak-Bon (KOR)	P1	P2	P3			8	3	NOR	P1	P2	P3												
	0		0	0	0				3		2	1	0												
8	3	NIELSEN M. (NOR)	P1	P2	P3			8	3	NOR	P1	P2	P3												
	5		1	4	0				3		2	1	0												
9	0	DUNDAR Taha Yasin (TUR)	P1	P2	P3			10	1	RUS	P1	P2	P3												
	0		0	0	0				1		0	1	0												
10	3	EVLOEV Musa (RUS)	P1	P2	P3			11	0	IRI	P1	P2	P3												
	4		3	1	0				0		0	0	0												
11	4	NOROOZI S. (IRI)	P1	P2	P3			14	3	GER	P1	P2	P3												
	13		7	6	0				4		2	2	0												
12	0	TANAKA Tetsuya (JPN)	P1	P2	P3			14	3	GER	P1	P2	P3												
	0		0	0	0				4		2	2	0												
13	1	SHI Wenhao (CHN)	P1	P2	P3			15	0	EGY	P1	P2	P3												
	2		2	0	0				0		0	0	0												
14	3	OEHLER Peter (GER)	P1	P2	P3			17	0	GEO	P1	P2	P3												
	7		0	1	6				0		0	0	0												
15	3	HAMDY MOSTAFA E. (EGY)	P1	P2	P3			17	3	GEO	P1	P2	P3												
	5		2	3	0				3		2	1	0												
16	0	SOOS Tamas (SVK)	P1	P2	P3			20	1	ARM	P1	P2	P3												
	0		0	0	0				4		2	2	0												
17	3	KAJAIA Iakobi (GEO)	P1	P2	P3			21	0	HON	P1	P2	P3												
	2		1	1	0				0		0	0	0												
18	0	YOSPAYAN Anucha (THA)	P1	P2	P3			21	3	HON	P1	P2	P3												
	0		0	0	0				6		0	3	3												
19	1	TOKTORBAEV T. (KGZ)	P1	P2	P3			23	0	UKR	P1	P2	P3												
	2		2	0	0				0		0	0	0												
20	3	SIMONYAN Vahe (ARM)	P1	P2	P3			23	3	UKR	P1	P2	P3												
	3		0	2	1				2		1	1	0												
21	3	MEJIA CASTILLO K. (HON)	P1	P2	P3			26	0	ISR	P1	P2	P3												
	2		1	1	0				0		0	0	0												
22	0	SHAIKENOV Yerkin (KAZ)	P1	P2	P3																				
	0		0	0	0																				
23	3	VOLOSHANIN Samir (UKR)	P1	P2	P3																				
	2		1	1	0																				
24	0	FINAU M. (USA)	P1	P2	P3																				
	0		0	0	0																				
25	1	HAKIMOV Dilshod (UZB)	P1	P2	P3																				
	4		0	4	0																				
26	3	GURIELASHVILI Naor (ISR)	P1	P2	P3																				
	3		1	1	1																				

3 LAURINAITIS Vilius (LTU)

Classement

Cl	Pays	Nom
1	LTU	LAURINAITIS Vilius
2	GER	OEHLER Peter
3	GEO	KAJAIA Iakobi
3	NOR	NIELSEN Marthin Hamlet
5	SWE	NYBERG Mikael Karl Axel
5	UKR	VOLOSHANIN Samir
7	IRI	NOROOZI Saman Abbas
8	HON	MEJIA CASTILLO Kevin
9	FIN	LAHTI Tuomas Heikki Juhani
10	ARM	SIMONYAN Vahe
11	RUS	EVLOEV Musa
12	AZE	ABDULLAYEV Abas
13	EGY	HAMDY MOSTAFA Elsaid
14	ISR	GURIELASHVILI Naor
15	CHN	SHI Wenhao
16	UZB	HAKIMOV Dilshod
17	KGZ	TOKTORBAEV Tynchtyk
18	GRE	TSEKERIDIS Dimitros
19	THA	YOSPAYAN Anucha
19	KAZ	SHAIKENOV Yerkin
19	USA	FINAU Marcus Anthony Lanakila
22	TUR	DUNDAR Taha Yasin
23	SVK	SOOS Tamas
23	KOR	GU Hak-Bon
25	IND	SUNIL Sunil
26	JPN	TANAKA Tetsuya

REPECHAGE

REPECHAGE FINALISTE 1

4	5	SWE	P1	P2	P3			4	0	SWE	P1	P2	P3		
	6		6	0	0				0		0	0	0		
2	0	AZE	P1	P2	P3			8	5	NOR	P1	P2	P3		
	0		0	0	0				4		1	3	0		

8 NIELSEN M. (NOR)

Mdaille de Bronze

REPECHAGE FINALISTE 2

13	1	CHN	P1	P2	P3			11	0	IRI	P1	P2	P3		
	2		0	2	0				0		0	0	0		
11	3	IRI	P1	P2	P3			17	3	GEO	P1	P2	P3		
	2		1	0	1				5		1	4	0		

17 KAJAIA Iakobi (GEO)

Mdaille de Bronze



Classement

Championnat du Monde - Junior

STYLE : GR 96 kg



1 - Or / Gold



LAURINAITIS Vilius

2 - Argent / Silver



OEHLER Peter

3 - Bronze



KAJAIA Iakobi



NIELSEN Marthin Hamlet

Classement	Nom - Name	Pays - Country
1	LAURINAITIS Vilius	LTU
2	OEHLER Peter	GER
3	KAJAIA Iakobi	GEO
3	NIELSEN M.	NOR
5	NYBERG M.	SWE
5	VOLOSHANIN Samir	UKR
7	NOROOZI Saman Abbas	IRI
8	MEJIA CASTILLO K.	HON
9	LAHTI T.	FIN
10	SIMONYAN Vahe	ARM
11	EVLOEV Musa	RUS
12	ABDULLAYEV Abas	AZE
13	HAMDY MOSTAFA E.	EGY
14	GURIELASHVILI Naor	ISR
15	SHI Wenhao	CHN
16	HAKIMOV Dilshod	UZB
17	TOKTORBAEV Tynchtyk	KGZ
18	TSEKERIDIS Dimitros	GRE
19	YOSPAYAN Anucha	THA
19	SHAIKENOV Yerkin	KAZ
19	FINAU M.	USA
22	DUNDAR Taha Yasin	TUR
23	SOOS Tamas	SVK
23	GU Hak-Bon	KOR
25	SUNIL Sunil	IND
26	TANAKA Tetsuya	JPN

