



43 Torneo Internacional Granma - Cerro Pelado
43 International Tournament Granma - Cerro Pelado
Lucha Libre / Free Style Wrestling



Participantes por Categoría / Participants by Categories

**55 kg / 55 kg
Hombres / Men**

Nombre Name	Equipo Team	Fecha Nac. Birthdate	Talla (cm) Height	Peso (Kg) Weight
CISNEROS, Alfredo	CUB			
EWALD, Marcel	GER			
HAZEWINKEL, Sam	USA			
HERGENHEIN, Jacob	CAN			
IBÁÑEZ, Luis A.	CUB			
SERRATA, Jeffry	DOM			
WILD, Urs	SUI			

**60 kg / 60 kg
Hombres / Men**

Nombre Name	Equipo Team	Fecha Nac. Birthdate	Talla (cm) Height	Peso (Kg) Weight
BONNE, Yowlys	CUB			
HAZEWINKEL, Sam	USA			
MUÑOZ, Jose Manuel	DOM			
QUINTANA, Davian	CUB			
RIZZOTTO, Vincenzo	ITA			
SCHLEICHER, Tim	GER			
SLEPTCOV, Fedot	RUS			
VALDES, Alejandro	CUB			

**66 kg / 66 kg
Hombres / Men**

Nombre Name	Equipo Team	Fecha Nac. Birthdate	Talla (cm) Height	Peso (Kg) Weight
AVILA, Jeffry	DOM			
BLANCO, Johan	ECU			
CAMPAGNA, Raimondo	ITA			
CARRANZA, Fernando	ARG			
DAUM, Martin	GER			
FRAYER, Jared	USA			
GARCIA, Gabriel	DOM			
LOPEZ, Livan	CUB			
MAREN, Franklyn	CUB			
MCCANLEY, Destin	USA			
MORENO, Andy	CUB			
PEREZ, Sebastian	ARG			
PISCITELLI, Pietro	ITA			
SILVA, Alfredo	ARG			
SOTO, Pedro	PUR			
WEICKER, Ryan	CAN			



43 Torneo Internacional Granma - Cerro Pelado
43 International Tournament Granma - Cerro Pelado

Lucha Libre / Free Style Wrestling

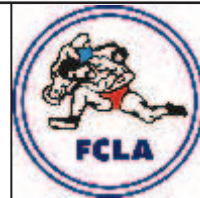

Participantes por Categoría / Participants by Categories

**74 kg / 74 kg
Hombres / Men**

Nombre Name	Equipo Team	Fecha Nac. Birthdate	Talla (cm) Height	Peso (Kg) Weight
BLANCO, Yunierry	CUB			
BURROUGHS, Jordan	USA			
CALDWELL, Tyler	USA			
FAY, Moza	USA			
LLANO, Ivan	ARG			
LUMIA, Carmelo	ITA			
MARABLE, Nick	USA			
MONTES DE OCA, Lazaro	CUB			
O'CONNOR, J.P	USA			
PAULSON, Trent	USA			
QUINTANA, Luis E.	CUB			
RAMIREZ, Angel	DOM			

**84 kg / 84 kg
Hombres / Men**

Nombre Name	Equipo Team	Fecha Nac. Birthdate	Talla (cm) Height	Peso (Kg) Weight
ARENCIBIA, Humberto	CUB			
ESPINAL, Jaime	PUR			
LEWNES, Mack	USA			
MIRANDA, Luis Mario	CUB			
PEREZ, Luis Manuel	DOM			
RIESEN, Marco	SUI			
SORBELLO, Andrea	ITA			

**96 kg / 96 kg
Hombres / Men**

Nombre Name	Equipo Team	Fecha Nac. Birthdate	Talla (cm) Height	Peso (Kg) Weight
CORTINA, Javier	CUB			
HALL, Tanner	USA			
HARTH, William	GER			
KILGORE, Dustin	USA			
MAIER, Yuri	ARG			
MESA, Eduardo	CUB			
ROWLANDS, Tommy	USA			
SCHWABE, Kevin	GER			
ZABRISKIE, David	USA			



43 Torneo Internacional Granma - Cerro Pelado
43 International Tournament Granma - Cerro Pelado
Lucha Libre / Free Style Wrestling

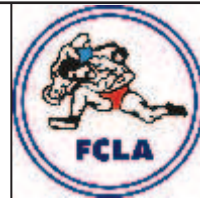

Participantes por Categoría / Participants by Categories

120 kg / 120 kg
Hombres / Men

Nombre Name	Equipo Team	Fecha Nac. Birthdate	Talla (cm) Height	Peso (Kg) Weight
DLAGNEV, Tervel	USA			
FELIX, Carlos Jose	DOM			
MATUHIN, Nick	GER			
RODRIGUEZ, Disney	CUB			
TRICE, Jarod	USA			



43 Torneo Internacional Granma - Cerro Pelado
43 International Tournament Granma - Cerro Pelado

Lucha Libre / Free Style Wrestling
Hombres / Men

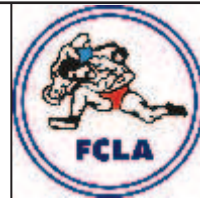

Resultados 55 kg / Results 55 kg (14/02/2012)

1/4

1/2

FINAL



TO - Victoria por pegada, Lesión, Retirada / Victory by fall, Injury, Withdrawal ST - Gran superioridad / Great superiority SP - Superioridad técnica / Technical superiority NP - No presentación / Forfeit
PP - Decisión por ptos, perdedor con ptos / Decision by points, the loser with points PO - Decisión por puntos, perdedor sin ptos / Decision by points, the loser without points EV - Descalificación / Disqualification
EX - 3 advertencias "0" / 3 cautions "0" E2 - Descalificación de ambos luchadores / Both wrestlers disqual



43 Torneo Internacional Granma - Cerro Pelado
 43 International Tournament Granma - Cerro Pelado

Lucha Libre / Free Style Wrestling
Hombres / Men



Resultados 55 kg / Results 55 kg (14/02/2012)

1/2

FINAL

Repechage 1

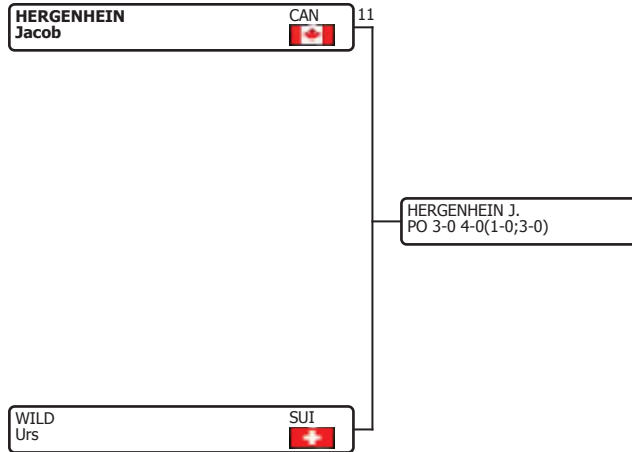

Repechage 2

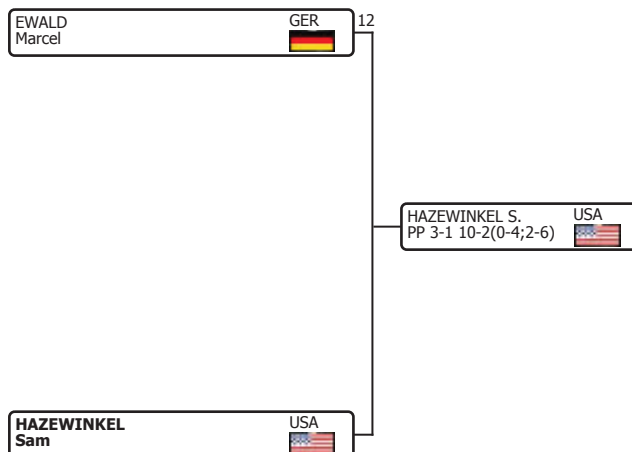

TO - Victoria por pegada, Lesión, Retirada / Victory by fall, Injury, Withdrawal ST - Gran superioridad / Great superiority SP - Superioridad técnica / Technical superiority NP - No presentación / Forfeit
 PP - Decisión por pts, perdedor con pts / Decision by points, the loser with points PO - Decisión por puntos, perdedor sin pts / Decision by points, the loser without points EV - Descalificación / Disqualification
 EX - 3 advertencias "0" / 3 cautions "0" E2 - Descalificación de ambos luchadores / Both wrestlers disqual



43 Torneo Internacional Granma - Cerro Pelado
43 International Tournament Granma - Cerro Pelado
Lucha Libre / Free Style Wrestling

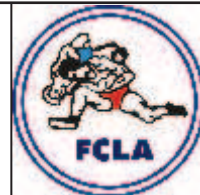

Clasificación Final / Final Standings

55 kg / 55 kg
Hombres / Men

Lugar Place	Nombre Name	Equipo Team	Puntos Points
1	IBAÑEZ, Luis A.	CUB	
2	CISNEROS, Alfredo	CUB	
3	HERGENHEIN, Jacob	CAN	
3	HAZEWINKEL, Sam	USA	
5	WILD, Urs	SUI	
5	EWALD, Marcel	GER	
7	SERRATA, Jeffry	DOM	



43 Torneo Internacional Granma - Cerro Pelado
 43 International Tournament Granma - Cerro Pelado
Lucha Libre / Free Style Wrestling
Hombres / Men

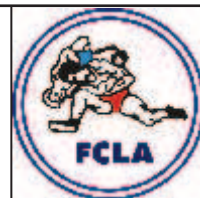

Resultados 60 kg / Results 60 kg (15/02/2012)

1/4

1/2

FINAL



TO - Victoria por pegada, Lesión, Retirada / Victory by fall, Injury, Withdrawal ST - Gran superioridad / Great superiority SP - Superioridad técnica / Technical superiority NP - No presentación / Forfeit
 PP - Decisión por pto., perdedor con pto. / Decision by points, the loser with points PO - Decisión por puntos, perdedor sin pto. / Decision by points, the loser without points EV - Descalificación / Disqualification
 EX - 3 advertencias "0" / 3 cautions "0" E2 - Descalificación de ambos luchadores / Both wrestlers disqual



43 Torneo Internacional Granma - Cerro Pelado
 43 International Tournament Granma - Cerro Pelado

Lucha Libre / Free Style Wrestling
Hombres / Men

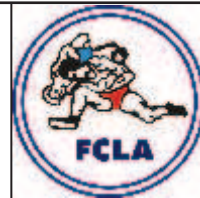

Resultados 60 kg / Results 60 kg (15/02/2012)

1/2

FINAL

Repechage 1

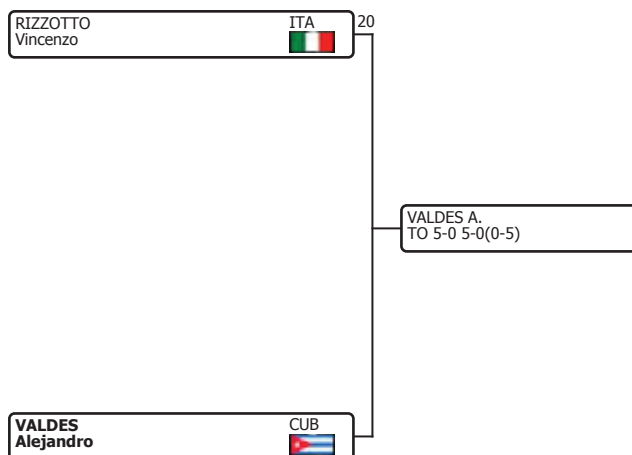

Repechage 2

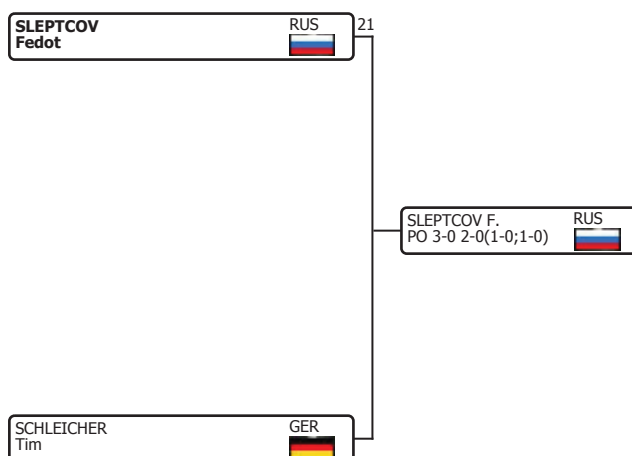

TO - Victoria por pegada, Lesión, Retirada / Victory by fall, Injury, Withdrawal ST - Gran superioridad / Great superiority SP - Superioridad técnica / Technical superiority NP - No presentación / Forfeit
 PP - Decisión por ptos, perdedor con ptos / Decision by points, the loser with points PO - Decisión por puntos, perdedor sin ptos / Decision by points, the loser without points EV - Descalificación / Disqualification
 EX - 3 advertencias "0" / 3 cautions "0" E2 - Descalificación de ambos luchadores / Both wrestlers disqual



43 Torneo Internacional Granma - Cerro Pelado
43 International Tournament Granma - Cerro Pelado
Lucha Libre / Free Style Wrestling

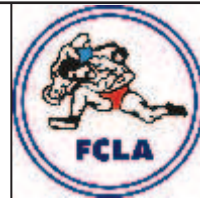

Clasificación Final / Final Standings

60 kg / 60 kg
Hombres / Men

Lugar Place	Nombre Name	Equipo Team	Puntos Points
1	BONNE, Yowlys	 CUB	
2	QUINTANA, Davian	 CUB	
3	VALDES, Alejandro	 CUB	
3	SLEPTCOV, Fedot	 RUS	
5	RIZZOTTO, Vincenzo	 ITA	
5	SCHLEICHER, Tim	 GER	
7	MUÑOZ, Jose Manuel	 DOM	
8	HAZEWINKEL, Sam	 USA	



43 Torneo Internacional Granma - Cerro Pelado
43 International Tournament Granma - Cerro Pelado
Lucha Libre / Free Style Wrestling
Hombres / Men

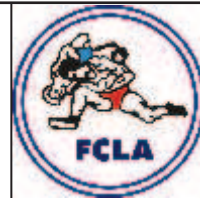

Resultados 66 kg / Results 66 kg (14/02/2012)

1/8

1/4

1/2

FINAL

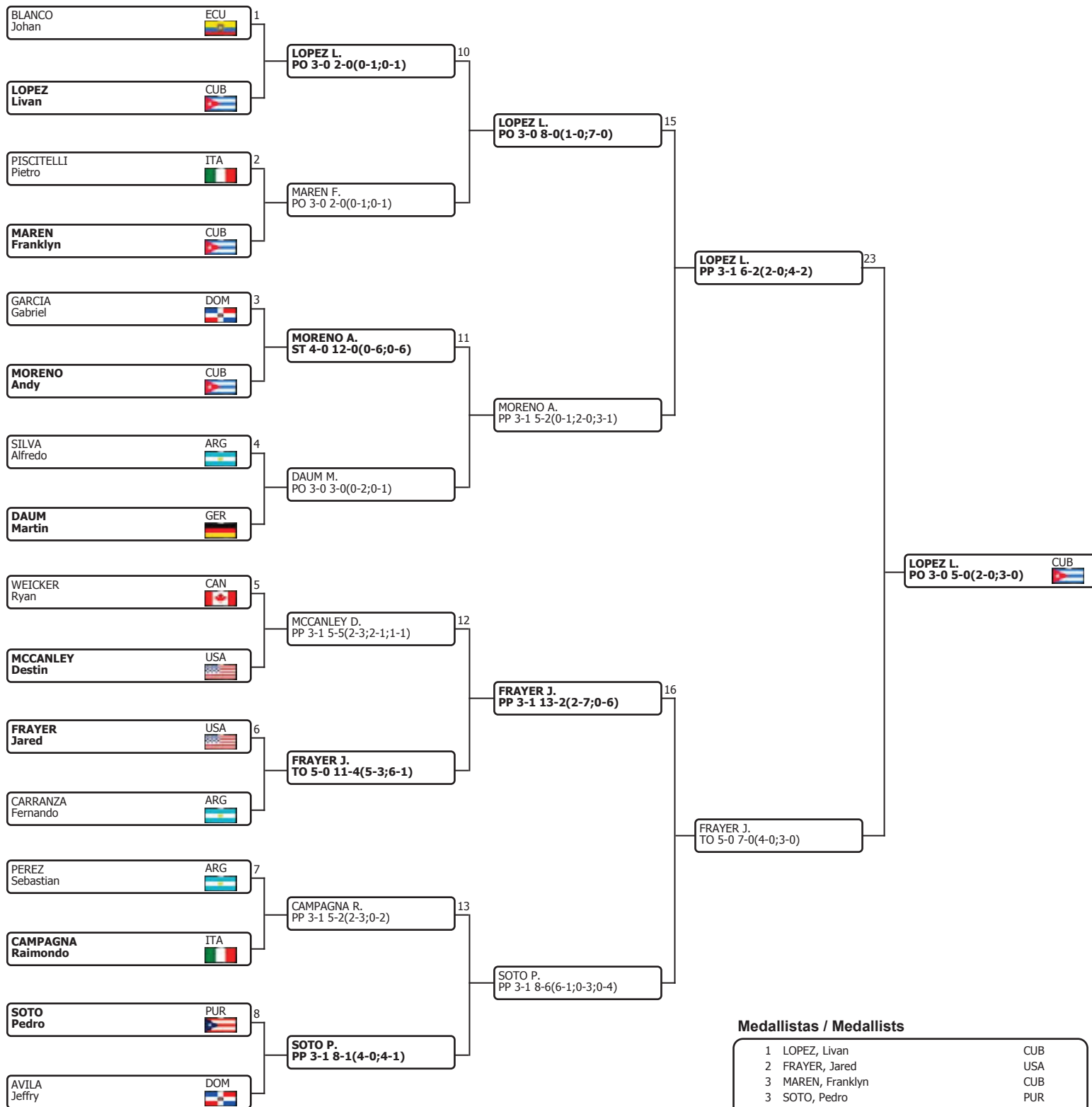

TO - Victoria por pegada, Lesión, Retirada / Victory by fall, Injury, Withdrawal ST - Gran superioridad / Great superiority SP - Superioridad técnica / Technical superiority NP - No presentación / Forfeit
PP - Decisión por ptos, perdedor con ptos / Decision by points, the loser with points PO - Decisión por puntos, perdedor sin ptos / Decision by points, the loser without points EV - Descalificación / Disqualification
EX - 3 advertencias "0" / 3 cautions "0" E2 - Descalificación de ambos luchadores / Both wrestlers disqual



43 Torneo Internacional Granma - Cerro Pelado
 43 International Tournament Granma - Cerro Pelado
Lucha Libre / Free Style Wrestling
Hombres / Men



Resultados 66 kg / Results 66 kg (14/02/2012)

1/4

1/2

FINAL

Repechage 1

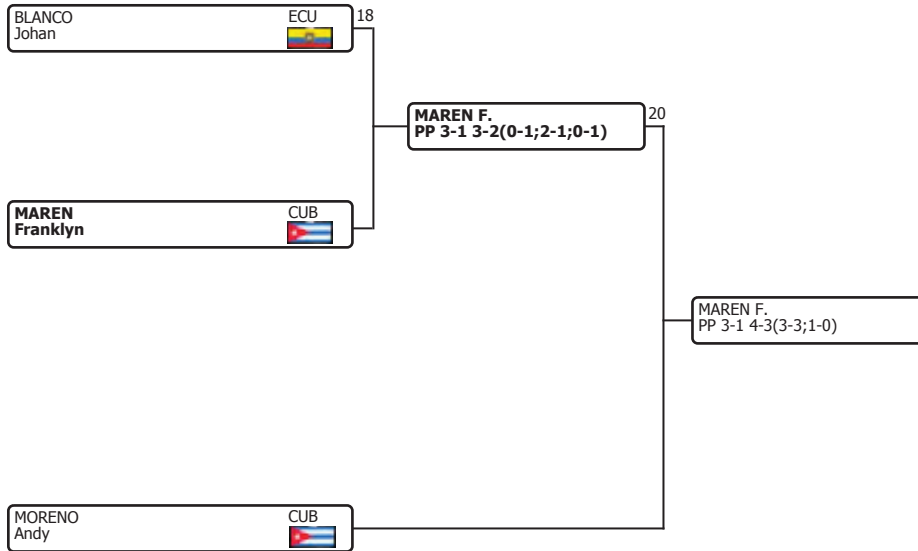

Repechage 2

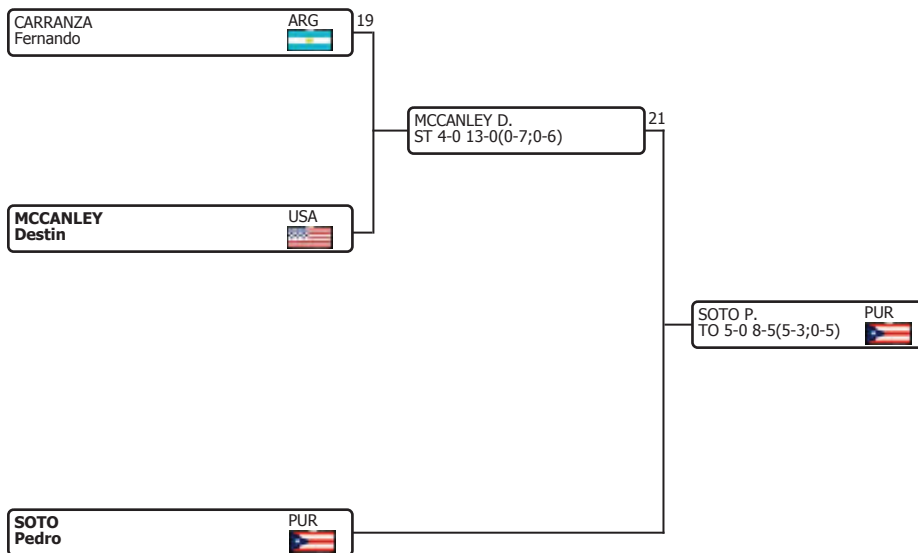

TO - Victoria por pegada, Lesión, Retirada / Victory by fall, Injury, Withdrawal ST - Gran superioridad / Great superiority SP - Superioridad técnica / Technical superiority NP - No presentación / Forfeit
 PP - Decisión por ptos, perdedor con ptos / Decision by points, the loser with points PO - Decisión por puntos, perdedor sin ptos / Decision by points, the loser without points EV - Descalificación / Disqualification
 EX - 3 advertencias "0" / 3 cautions "0" E2 - Descalificación de ambos luchadores / Both wrestlers disqual



43 Torneo Internacional Granma - Cerro Pelado
43 International Tournament Granma - Cerro Pelado
Lucha Libre / Free Style Wrestling



Clasificación Final / Final Standings

66 kg / 66 kg
Hombres / Men

Lugar Place	Nombre Name	Equipo Team	Puntos Points
1	LOPEZ, Livan	CUB	
2	FRAYER, Jared	USA	
3	MAREN, Franklyn	CUB	
3	SOTO, Pedro	PUR	
5	MORENO, Andy	CUB	
5	MCCANLEY, Destin	USA	
7	BLANCO, Johan	ECU	
8	CARRANZA, Fernando	ARG	
9	CAMPAGNA, Raimondo	ITA	
10	DAUM, Martin	GER	
11	WEICKER, Ryan	CAN	
12	PEREZ, Sebastian	ARG	
13	AVILA, Jeffry	DOM	
14	PISCITELLI, Pietro	ITA	
15	SILVA, Alfredo	ARG	
16	GARCIA, Gabriel	DOM	



43 Torneo Internacional Granma - Cerro Pelado
 43 International Tournament Granma - Cerro Pelado
Lucha Libre / Free Style Wrestling
Hombres / Men



Resultados 74 kg / Results 74 kg (15/02/2012)

1/8

1/4

1/2

FINAL

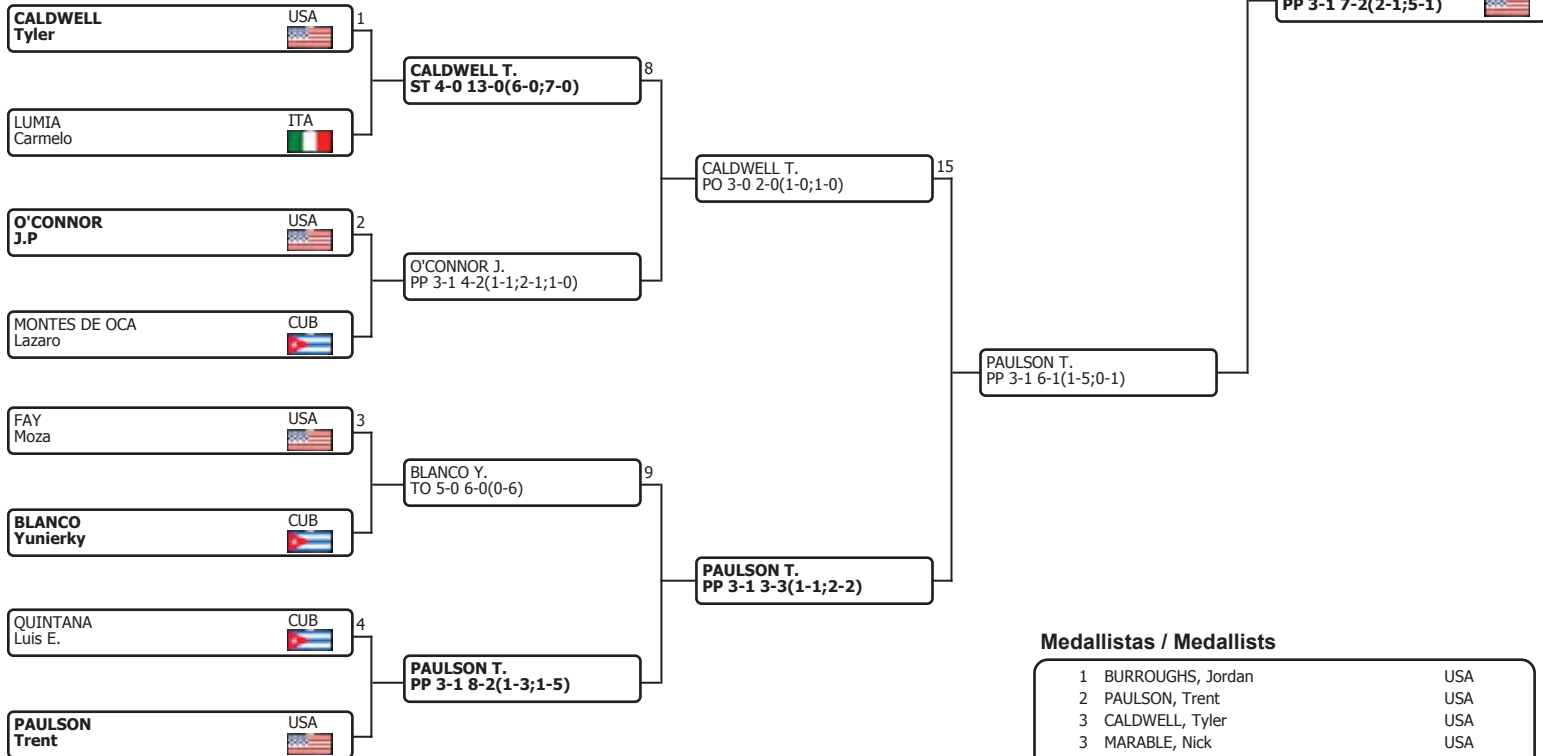
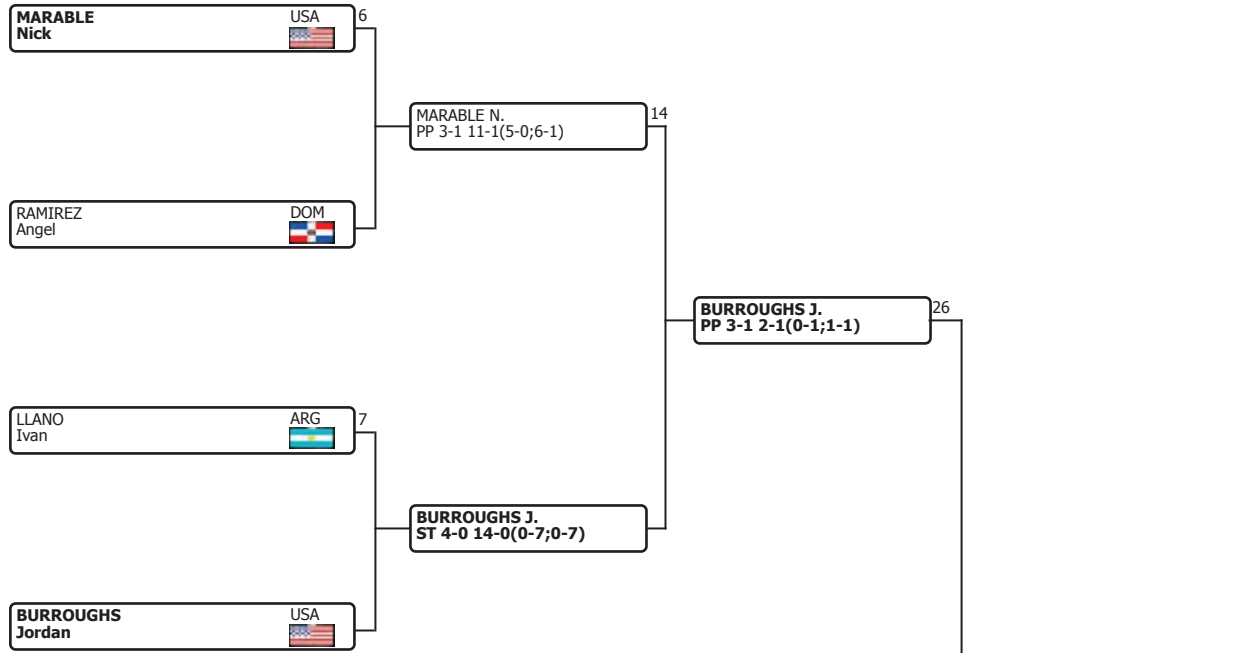

Medallistas / Medallists

1	BURROUGHS, Jordan	USA
2	PAULSON, Trent	USA
3	CALDWELL, Tyler	USA
3	MARABLE, Nick	USA

TO - Victoria por pegada, Lesión, Retirada / Victory by fall, Injury, Withdrawal ST - Gran superioridad / Great superiority SP - Superioridad técnica / Technical superiority NP - No presentación / Forfeit
 PP - Decisión por ptos, perdedor con ptos / Decision by points, the loser with points PO - Decisión por puntos, perdedor sin ptos / Decision by points, the loser without points EV - Descalificación / Disqualification
 EX - 3 advertencias "0" / 3 cautions "0" E2 - Descalificación de ambos luchadores / Both wrestlers disqual



43 Torneo Internacional Granma - Cerro Pelado
 43 International Tournament Granma - Cerro Pelado

Lucha Libre / Free Style Wrestling
Hombres / Men

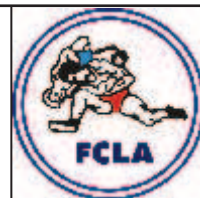

Resultados 74 kg / Results 74 kg (15/02/2012)

1/4

1/2

FINAL

Repechage 1

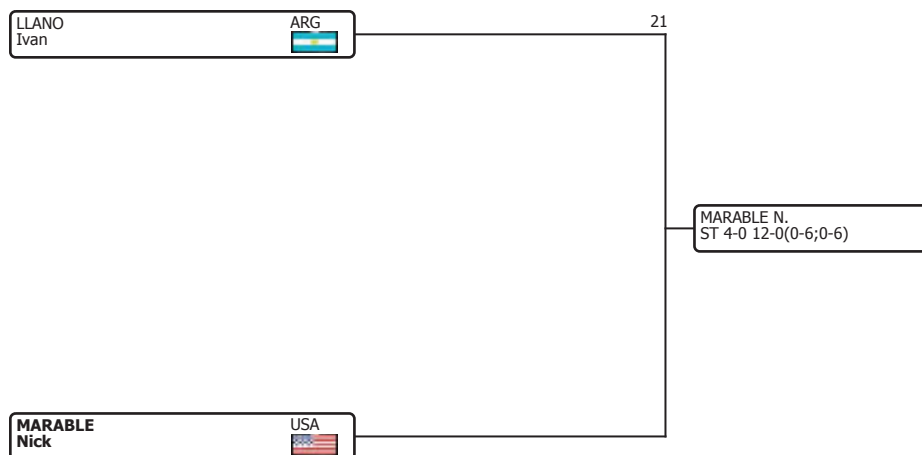

Repechage 2

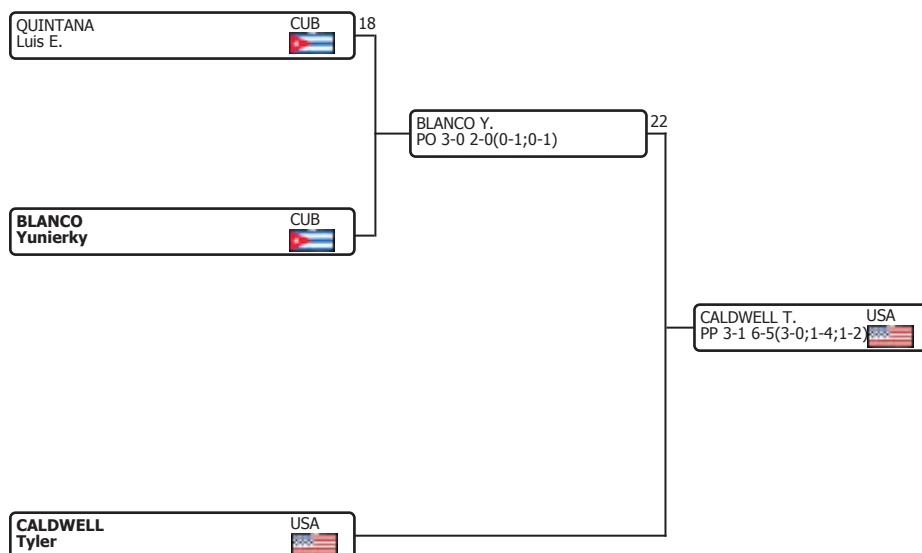

TO - Victoria por pegada, Lesión, Retirada / Victory by fall, Injury, Withdrawal ST - Gran superioridad / Great superiority SP - Superioridad técnica / Technical superiority NP - No presentación / Forfeit
 PP - Decisión por ptos, perdedor con ptos / Decision by points, the loser with points PO - Decisión por puntos, perdedor sin ptos / Decision by points, the loser without points EV - Descalificación / Disqualification
 EX - 3 advertencias "0" / 3 cautions "0" E2 - Descalificación de ambos luchadores / Both wrestlers disqual



43 Torneo Internacional Granma - Cerro Pelado
43 International Tournament Granma - Cerro Pelado
Lucha Libre / Free Style Wrestling



Clasificación Final / Final Standings

74 kg / 74 kg
Hombres / Men

Lugar Place	Nombre Name	Equipo Team	Puntos Points
1	BURROUGHS, Jordan	USA	
2	PAULSON, Trent	USA	
3	CALDWELL, Tyler	USA	
3	MARABLE, Nick	USA	
5	LLANO, Ivan	ARG	
5	BLANCO, Yunierky	CUB	
7	QUINTANA, Luis E.	CUB	
8	O'CONNOR, J.P	USA	
9	RAMIREZ, Angel	DOM	
10	MONTES DE OCA, Lazaro	CUB	
11	LUMIA, Carmelo	ITA	
12	FAY, Moza	USA	



43 Torneo Internacional Granma - Cerro Pelado
 43 International Tournament Granma - Cerro Pelado
Lucha Libre / Free Style Wrestling
 Hombres / Men



Resultados 84 kg / Results 84 kg (15/02/2012)

1/4

1/2

FINAL

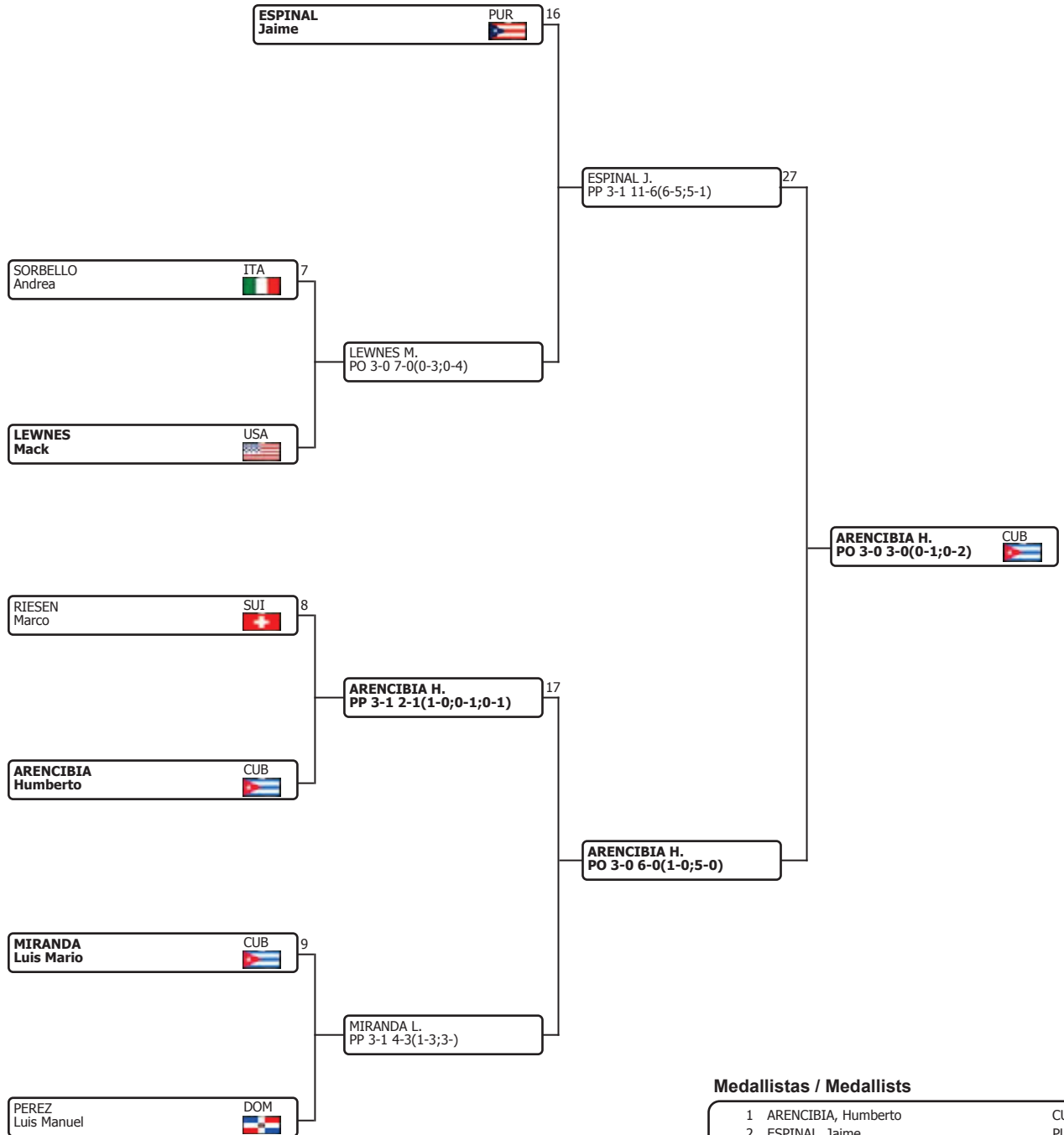

TO - Victoria por pegada, Lesión, Retirada / Victory by fall, Injury, Withdrawal ST - Gran superioridad / Great superiority SP - Superioridad técnica / Technical superiority NP - No presentación / Forfeit
 PP - Decisión por ptos, perdedor con ptos / Decision by points, the loser with points PO - Decisión por puntos, perdedor sin ptos / Decision by points, the loser without points EV - Descalificación / Disqualification
 EX - 3 advertencias "0" / 3 cautions "0" E2 - Descalificación de ambos luchadores / Both wrestlers disqual



43 Torneo Internacional Granma - Cerro Pelado
 43 International Tournament Granma - Cerro Pelado

Lucha Libre / Free Style Wrestling
Hombres / Men



Resultados 84 kg / Results 84 kg (15/02/2012)

1/2

FINAL

Repechage 1

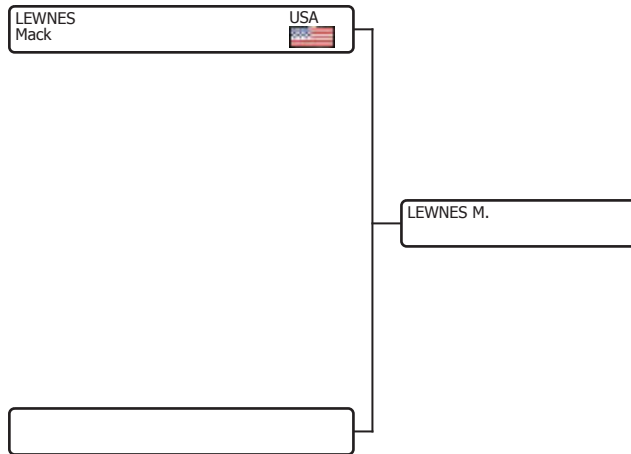

Repechage 2

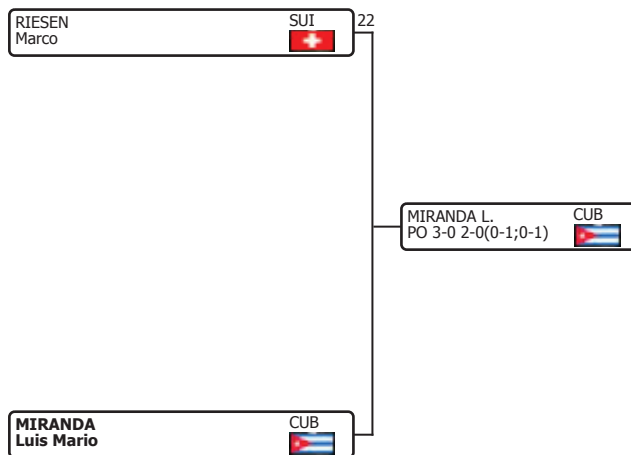

TO - Victoria por pegada, Lesión, Retirada / Victory by fall, Injury, Withdrawal ST - Gran superioridad / Great superiority SP - Superioridad técnica / Technical superiority NP - No presentación / Forfeit
 PP - Decisión por ptos, perdedor con ptos / Decision by points, the loser with points PO - Decisión por puntos, perdedor sin ptos / Decision by points, the loser without points EV - Descalificación / Disqualification
 EX - 3 advertencias "0" / 3 cautions "0" E2 - Descalificación de ambos luchadores / Both wrestlers disqual



43 Torneo Internacional Granma - Cerro Pelado
43 International Tournament Granma - Cerro Pelado
Lucha Libre / Free Style Wrestling

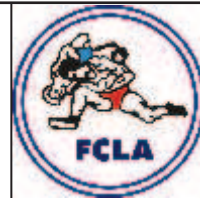

Clasificación Final / Final Standings

84 kg / 84 kg
Hombres / Men

Lugar Place	Nombre Name	Equipo Team	Puntos Points
1	ARENCIBIA, Humberto	 CUB	
2	ESPINAL, Jaime	 PUR	
3	MIRANDA, Luis Mario	 CUB	
3	LEWNES, Mack	 USA	
5	RIESEN, Marco	 SUI	
6	PEREZ, Luis Manuel	 DOM	
7	SORBELLO, Andrea	 ITA	



43 Torneo Internacional Granma - Cerro Pelado
 43 International Tournament Granma - Cerro Pelado
Lucha Libre / Free Style Wrestling
 Hombres / Men

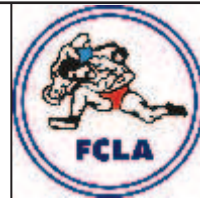

Resultados 96 kg / Results 96 kg (15/02/2012)

1/8

1/4

1/2

FINAL



TO - Victoria por pegada, Lesión, Retirada / Victory by fall, Injury, Withdrawal ST - Gran superioridad / Great superiority SP - Superioridad técnica / Technical superiority NP - No presentación / Forfeit
 PP - Decisión por ptos, perdedor con ptos / Decision by points, the loser with points PO - Decisión por puntos, perdedor sin ptos / Decision by points, the loser without points EV - Descalificación / Disqualification
 EX - 3 advertencias "0" / 3 cautions "0" E2 - Descalificación de ambos luchadores / Both wrestlers disqual



43 Torneo Internacional Granma - Cerro Pelado
43 International Tournament Granma - Cerro Pelado

Lucha Libre / Free Style Wrestling
Hombres / Men

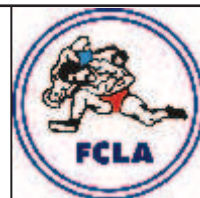

Resultados 96 kg / Results 96 kg (15/02/2012)

1/4

1/2

FINAL

Repechage 1

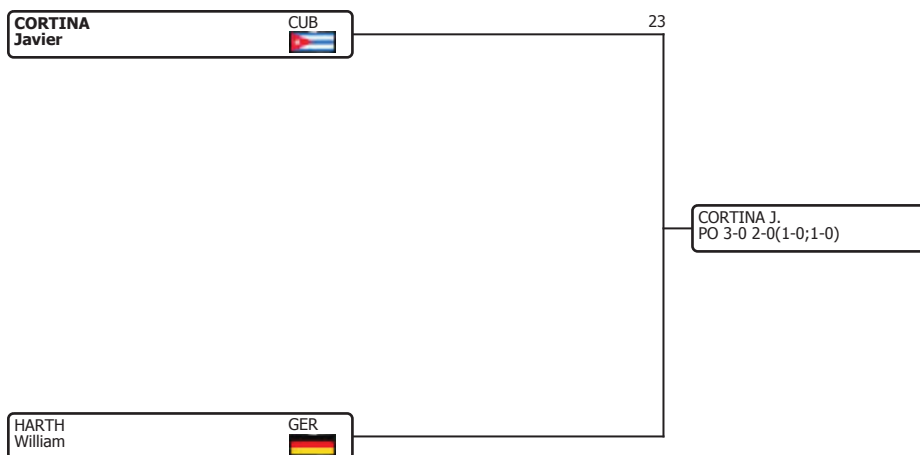

Repechage 2

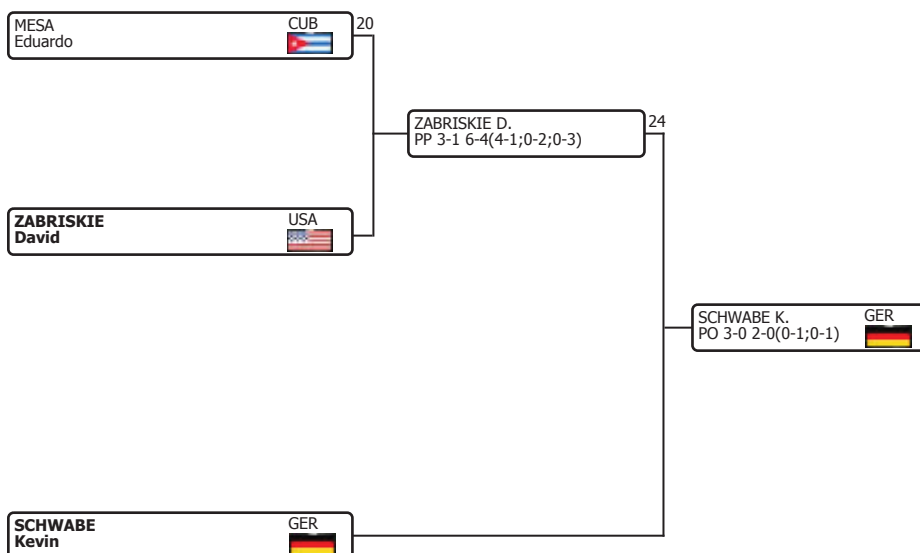

TO - Victoria por pegada, Lesión, Retirada / Victory by fall, Injury, Withdrawal ST - Gran superioridad / Great superiority SP - Superioridad técnica / Technical superiority NP - No presentación / Forfeit
PP - Decisión por ptos, perdedor con ptos / Decision by points, the loser with points PO - Decisión por puntos, perdedor sin ptos / Decision by points, the loser without points EV - Descalificación / Disqualification
EX - 3 advertencias "0" / 3 cautions "0" E2 - Descalificación de ambos luchadores / Both wrestlers disqual



43 Torneo Internacional Granma - Cerro Pelado
43 International Tournament Granma - Cerro Pelado
Lucha Libre / Free Style Wrestling

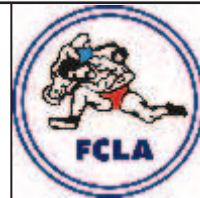

Clasificación Final / Final Standings

96 kg / 96 kg
Hombres / Men

Lugar Place	Nombre Name	Equipo Team	Puntos Points
1	KILGORE, Dustin	USA	
2	ROWLANDS, Tommy	USA	
3	CORTINA, Javier	CUB	
3	SCHWABE, Kevin	GER	
5	HARTH, William	GER	
5	ZABRISKIE, David	USA	
7	MESA, Eduardo	CUB	
8	HALL, Tanner	USA	
9	MAIER, Yuri	ARG	



43 Torneo Internacional Granma - Cerro Pelado
 43 International Tournament Granma - Cerro Pelado
Lucha Libre / Free Style Wrestling
 Hombres / Men



Resultados 120 kg / Results 120 kg (15/02/2012)

	I	II	III	IV	V	Vict	P Clasif.	P Tec.
1	USA TRICE, Jarod	[2] 3 [5] 3 [4] 0 [3] 0				2	6	4
	PP 2 PO 2 PO 0 PO 0							
2	CUB RODRIGUEZ, Disney	[1] 1 [3] 1 [5] 0 [4] 0				0	2	8
	PP 2 PP 6 TO 0 TO 0							
3	GER MATUHIN, Nick	[4] 0 [2] 3 [1] 3 [5] 3				3	9	12
	PO 0 PP 2 PO 8 PO 2							
4	USA DLAGNEV, Tervel	[3] 3 [1] 3 [5] 4 [2] 5				4	15	24
	PO 3 PO 9 ST 12 TO 0							
5	DOM FELIX, Carlos Jose	[1] 0 [2] 5 [4] 0 [3] 0				1	5	0
	PO 0 TO 0 ST 0 PO 0							

Clasificación Final / Final Standings

Lugar Rank	Equipo Team	Nombre Name
1	USA	DLAGNEV, Tervel
2	GER	MATUHIN, Nick
3	USA	TRICE, Jarod
4	DOM	FELIX, Carlos Jose
5	CUB	RODRIGUEZ, Disney

Leyenda / Legend

[A]	PC
[D]	PT

[A]: Adversario / Adversary PC: Puntos de Clasificación / Classification Points
 [D]: Decisión / Decision PT: Puntos Técnicos / Technical Points

TO - Victoria por pegada, Lesión, Retirada / Victory by fall, injury, withdrawal ST - Gran superioridad / Great superiority SP - Superioridad técnica / Technical superiority NP - No presentación / Forfeit
 PP - Decisión, perdedor con ptos / Decision by points, the loser with points PO - Decisión, perdedor sin ptos / Decision by points, the loser without points EV - Descalificación / Disqualification
 EX - 3 advertencias "0" / 3 cautions "0" E2 - Descalificación de ambos luchadores / Both wrestlers disqual



43 Torneo Internacional Granma - Cerro Pelado
43 International Tournament Granma - Cerro Pelado
Lucha Libre / Free Style Wrestling

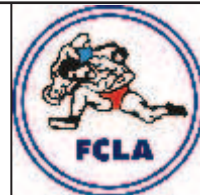

Clasificación Final / Final Standings

120 kg / 120 kg
Hombres / Men

Lugar Place	Nombre Name	Equipo Team	Puntos Points
1	DLAGNEV, Tervel	USA	
2	MATUHIN, Nick	GER	
3	TRICE, Jarod	USA	
4	FELIX, Carlos Jose	DOM	
5	RODRIGUEZ, Disney	CUB	



43 Torneo Internacion Granma - Cerro Pelado
43 International Tournament Granma - Cerro Pelado
Lucha Greco / Greco-Roman Wrestling

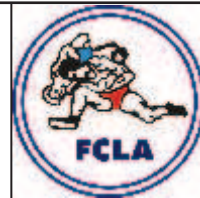

Participantes por Categoría / Participants by Categories

55 kg / 55 kg

Nombre Name	Equipo Team	Fecha Nac. Birthdate	Talla (cm) Height	Peso (Kg) Weight
BALART, Gustavo	CUB			
DUMENIGO, Javier	CUB			
HIDALGO, Magdiel	CUB			
HOGLMEIER, Lukas	GER			
MANEA, Federico	ITA			
MONTAÑO, Andres	ECU			
NOVAS, Cristian	DOM			
NOWRY, Max	USA			
RONNINGEN, Anders	NOR			
RONNINGEN, Thomas	NOR			
ZAIDOV, Ceyhun	GER			

60 kg / 60 kg

Nombre Name	Equipo Team	Fecha Nac. Birthdate	Talla (cm) Height	Peso (Kg) Weight
ANACHE, Maikel	CUB			
BAST, Christoph	GER			
BERGE, Stig Andre	NOR			
BETTERMAN, Joe	USA			
BORRERO, Ismael	CUB			
MAGRI, Vincenzo	ITA			
MELITA, Nehmen	ARG			
MEOQUE, Hanser	CUB			
WEIK, Erik	GER			

66 kg / 66 kg

Nombre Name	Equipo Team	Fecha Nac. Birthdate	Talla (cm) Height	Peso (Kg) Weight
CORRIGA, Tiziano	ITA			
MAGNI, Ricardo	ITA			
MAÑON, Jhomaylen	DOM			
MARTINEZ, Miguel	CUB			
MULEN, Pedro Isaac	CUB			
SCHLATTER, C.P	USA			
STABLER, Frank	GER			
THOMMESEN, Marius	NOR			



43 Torneo Internacion Granma - Cerro Pelado
43 International Tournament Granma - Cerro Pelado
Lucha Greco / Greco-Roman Wrestling

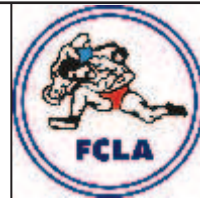

Participantes por Categoría / Participants by Categories

74 kg / 74 kg

Nombre Name	Equipo Team	Fecha Nac. Birthdate	Talla (cm) Height	Peso (Kg) Weight
ALVAREZ, Jorgisbell	CUB			
BADUSCH, Timo	GER			
BELL, Alexei	CUB			
BISEK, Andy	USA			
CONSUEGRA, Mayli	CUB			
HUBIERA, Alvaro	DOM			
MOTA, Anyelo	DOM			
PROVISOR, Ben	USA			
RUDENZANO, Maximiliano	ARG			
SCARAMUZZI, Saverio	ITA			
SCHNEIDER, Konstantin	GER			
TJORSTAD, Rasmus	NOR			

84 kg / 84 kg

Nombre Name	Equipo Team	Fecha Nac. Birthdate	Talla (cm) Height	Peso (Kg) Weight
ARIAS, Jose Antonio	DOM			
AZISIR, Ramsin	GER			
BETTS, Chas	USA			
FISCHER, Jan	GER			
GOMEZ, Joan Antonio	DOM			
HOLM, Jordan	USA			
MATUZEVICIUS, Julius	LTU			
MINGUZZI, Andrea	ITA			
SCIBILIA, Vincenzo	ITA			
SHOREY, Pablo	CUB			
VERA, Alan	CUB			

96 kg / 96 kg

Nombre Name	Equipo Team	Fecha Nac. Birthdate	Talla (cm) Height	Peso (Kg) Weight
ENGLICH, Mirko	GER			
ESTRADA, Yunior	CUB			
HASSLER, Oliver	GER			
LAURINAITIS, Vilius	LTU			
LUGO, Yasmani	CUB			
MAIER, Yuri	ARG			
NIELSEN, Marthin	NOR			
RUIZ, Justin	USA			
SCIBILIA, Beniamino	ITA			
TIMONCINI, Daigoro	ITA			



43 Torneo Internacion Granma - Cerro Pelado
43 International Tournament Granma - Cerro Pelado
Lucha Greco / Greco-Roman Wrestling

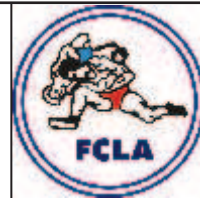

Participantes por Categoría / Participants by Categories

120 kg / 120 kg

Nombre Name	Equipo Team	Fecha Nac. Birthdate	Talla (cm) Height	Peso (Kg) Weight
ACOSTA, Yasmani	 CUB			
BOHRINGER, Ralf	 GER			
ENCARNACION, Josue	 DOM			
FAHAH, Mohamed	 EGY			
FICARA, Rocco	 ITA			
GARCIA, Ramon Antonio	 DOM			
LOPEZ, Mijain	 CUB			



43 Torneo Internacion Granma - Cerro Pelado
 43 International Tournament Granma - Cerro Pelado
Lucha Greco / Greco-Roman Wrestling
 Hombres / Men



Resultados 55 kg / Results 55 kg (12/02/2012)

1/8

1/4

1/2

FINAL

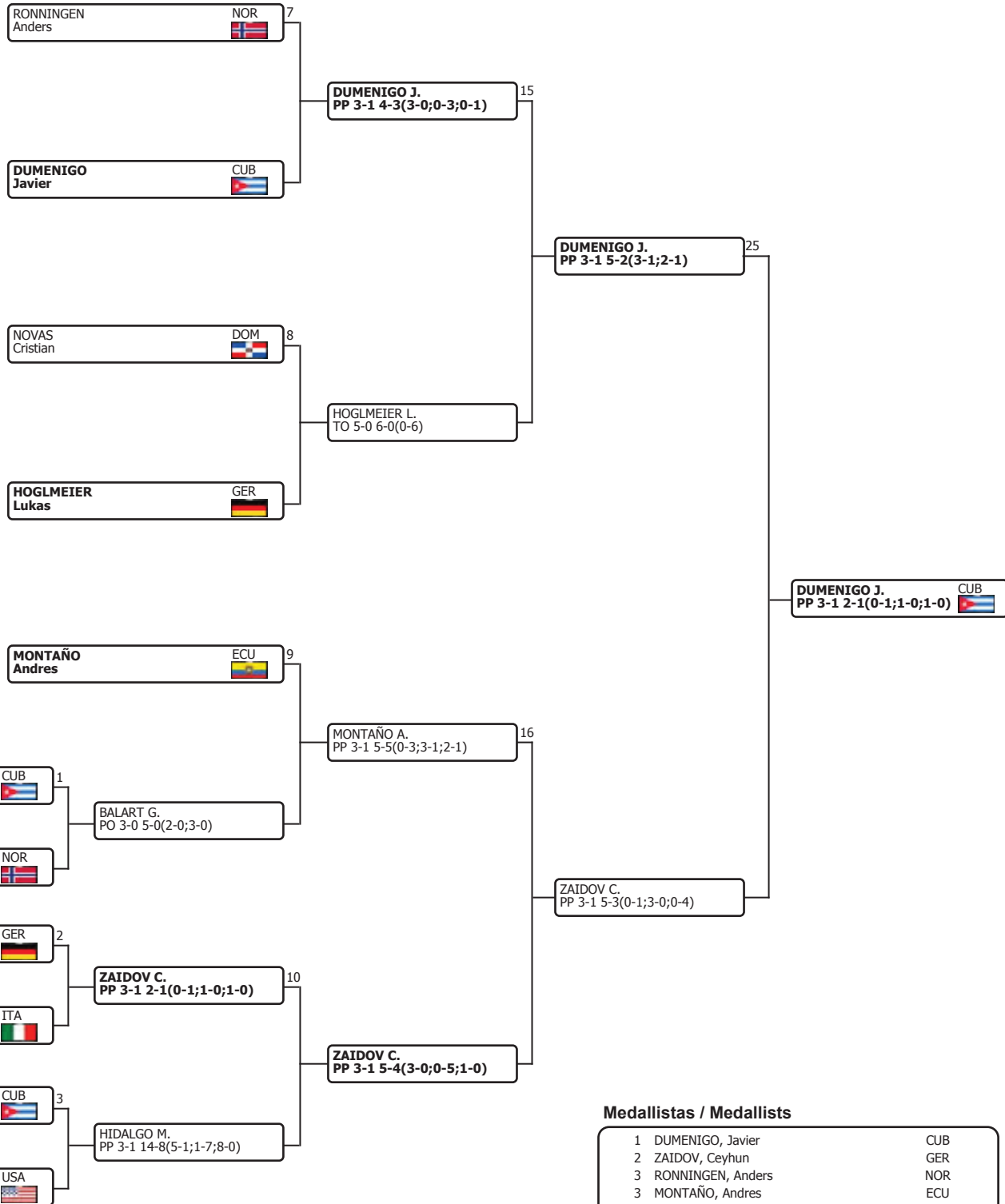

TO - Victoria por pegada, Lesión, Retirada / Victory by fall, Injury, Withdrawal ST - Gran superioridad / Great superiority SP - Superioridad técnica / Technical superiority NP - No presentación / Forfeit
 PP - Decisión por pto., perdedor con pto. / Decision by points, the loser with points PO - Decisión por puntos, perdedor sin pto. / Decision by points, the loser without points EV - Descalificación / Disqualification
 EX - 3 advertencias "0" / 3 cautions "0" E2 - Descalificación de ambos luchadores / Both wrestlers disqual



43 Torneo Internacion Granma - Cerro Pelado
 43 International Tournament Granma - Cerro Pelado
Lucha Greco / Greco-Roman Wrestling
 Hombres / Men



Resultados 55 kg / Results 55 kg (12/02/2012)

1/4

1/2

FINAL

Repechage 1

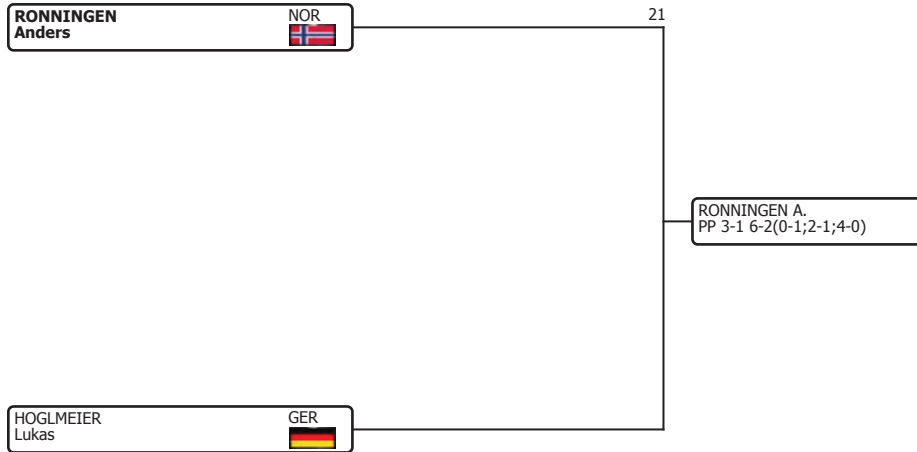

Repechage 2

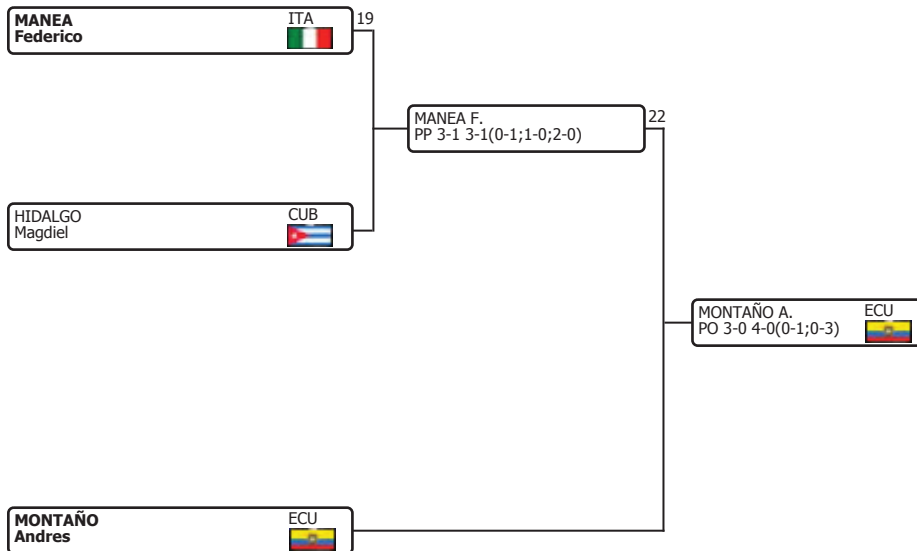

TO - Victoria por pegada, Lesión, Retirada / Victory by fall, Injury, Withdrawal ST - Gran superioridad / Great superiority SP - Superioridad técnica / Technical superiority NP - No presentación / Forfeit
 PP - Decisión por ptos, perdedor con ptos / Decision by points, the loser with points PO - Decisión por puntos, perdedor sin ptos / Decision by points, the loser without points EV - Descalificación / Disqualification
 EX - 3 advertencias "0" / 3 cautions "0" E2 - Descalificación de ambos luchadores / Both wrestlers disqual



43 Torneo Internacion Granma - Cerro Pelado
43 International Tournament Granma - Cerro Pelado
Lucha Greco / Greco-Roman Wrestling

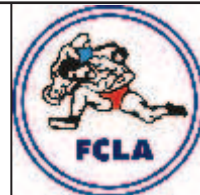

Clasificación Final / Final Standings

55 kg / 55 kg

Lugar Place	Nombre Name	Equipo Team	Puntos Points
1	DUMENIGO, Javier	CUB	
2	ZAIDOV, Ceyhun	GER	
3	RONNINGEN, Anders	NOR	
3	MONTAÑO, Andres	ECU	
5	HOGLMEIER, Lukas	GER	
5	MANEA, Federico	ITA	
7	BALART, Gustavo	CUB	
8	HIDALGO, Magdiel	CUB	
9	NOVAS, Cristian	DOM	
10	NOWRY, Max	USA	
11	RONNINGEN, Thomas	NOR	



43 Torneo Internacion Granma - Cerro Pelado
 43 International Tournament Granma - Cerro Pelado
Lucha Greco / Greco-Roman Wrestling
 Hombres / Men



Resultados 60 kg / Results 60 kg (13/02/2012)

1/8

1/4

1/2

FINAL



TO - Victoria por pegada, Lesión, Retirada / Victory by fall, Injury, Withdrawal ST - Gran superioridad / Great superiority SP - Superioridad técnica / Technical superiority NP - No presentación / Forfeit
 PP - Decisión por ptos, perdedor con ptos / Decision by points, the loser with points PO - Decisión por puntos, perdedor sin ptos / Decision by points, the loser without points EV - Descalificación / Disqualification
 EX - 3 advertencias "0" / 3 cautions "0" E2 - Descalificación de ambos luchadores / Both wrestlers disqual



43 Torneo Internacion Granma - Cerro Pelado
 43 International Tournament Granma - Cerro Pelado
Lucha Greco / Greco-Roman Wrestling
 Hombres / Men



Resultados 60 kg / Results 60 kg (13/02/2012)

1/4

1/2

FINAL

Repechage 1

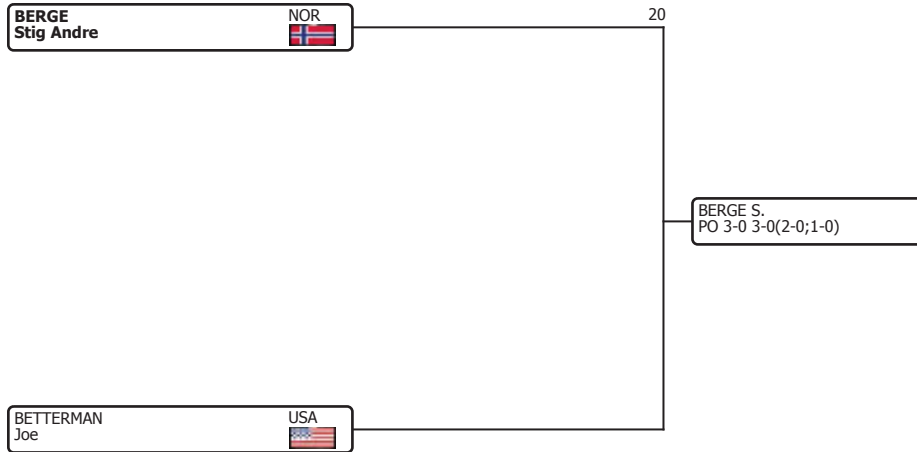

Repechage 2

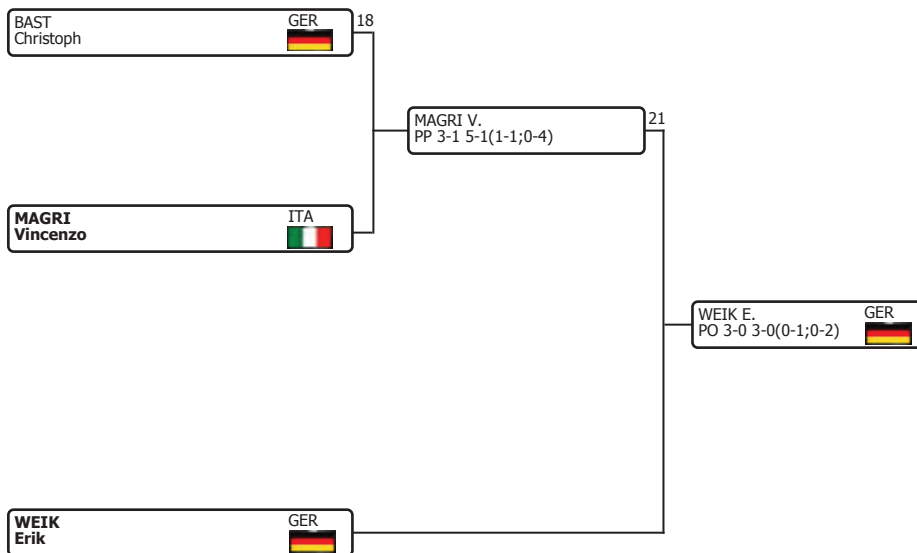

TO - Victoria por pegada, Lesión, Retirada / Victory by fall, Injury, Withdrawal ST - Gran superioridad / Great superiority SP - Superioridad técnica / Technical superiority NP - No presentación / Forfeit
 PP - Decisión por ptos, perdedor con ptos / Decision by points, the loser with points PO - Decisión por puntos, perdedor sin ptos / Decision by points, the loser without points EV - Descalificación / Disqualification
 EX - 3 advertencias "0" / 3 cautions "0" E2 - Descalificación de ambos luchadores / Both wrestlers disqual





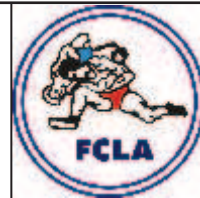





43 Torneo Internacion Granma - Cerro Pelado
43 International Tournament Granma - Cerro Pelado
Lucha Greco / Greco-Roman Wrestling



Clasificación Final / Final Standings

60 kg / 60 kg

Lugar Place	Nombre Name	Equipo Team	Puntos Points
1	ANACHE, Maikel	 CUB	
2	MEOQUE, Hanser	 CUB	
3	WEIK, Erik	 GER	
3	BERGE, Stig Andre	 NOR	
5	MAGRI, Vincenzo	 ITA	
5	BETTERMAN, Joe	 USA	
7	BAST, Christoph	 GER	
8	BORRERO, Ismael	 CUB	
9	MELITA, Nehmen	 ARG	



43 Torneo Internacion Granma - Cerro Pelado
 43 International Tournament Granma - Cerro Pelado
Lucha Greco / Greco-Roman Wrestling
 Hombres / Men



Resultados 66 kg / Results 66 kg (12/02/2012)

1/4

1/2

FINAL

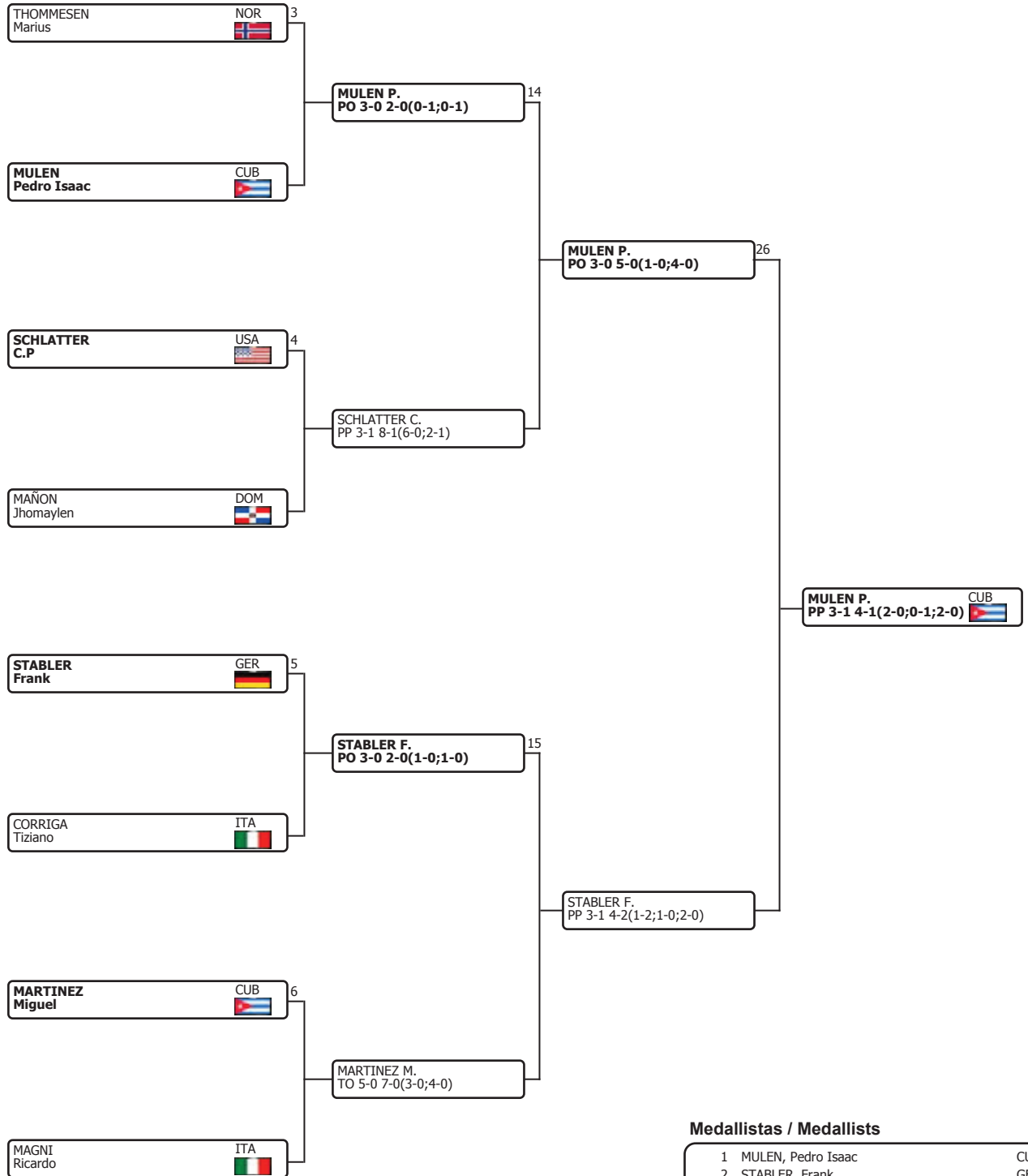

Medallistas / Medallists

1	MULEN, Pedro Isaac	CUB
2	STABLER, Frank	GER
3	SCHLATTER, C.P	USA
3	MARTINEZ, Miguel	CUB

TO - Victoria por pegada, Lesión, Retirada / Victory by fall, Injury, Withdrawal ST - Gran superioridad / Great superiority SP - Superioridad técnica / Technical superiority NP - No presentación / Forfeit
 PP - Decisión por pto., perdedor con pto. / Decision by points, the loser with points PO - Decisión por puntos, perdedor sin pto. / Decision by points, the loser without points EV - Descalificación / Disqualification
 EX - 3 advertencias "0" / 3 cautions "0" E2 - Descalificación de ambos luchadores / Both wrestlers disqual



43 Torneo Internacion Granma - Cerro Pelado
 43 International Tournament Granma - Cerro Pelado
Lucha Greco / Greco-Roman Wrestling
 Hombres / Men



Resultados 66 kg / Results 66 kg (12/02/2012)

1/2

FINAL

Repechage 1

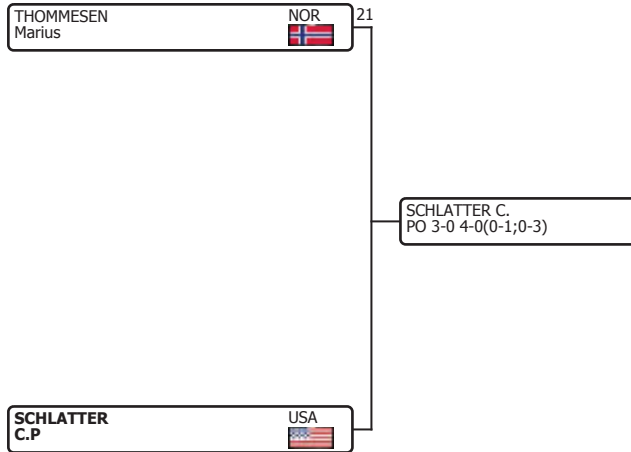

Repechage 2

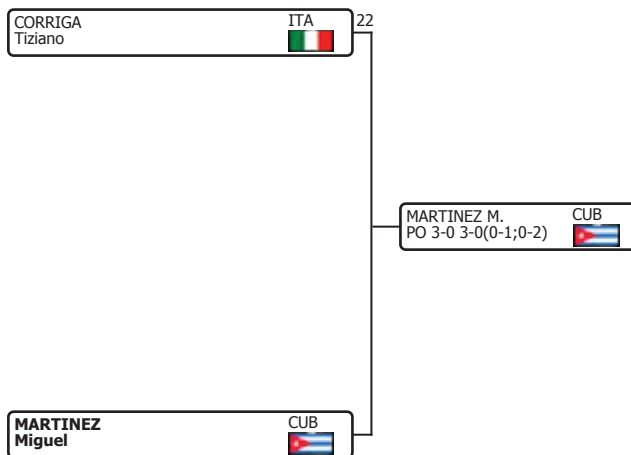



43 Torneo Internacion Granma - Cerro Pelado
43 International Tournament Granma - Cerro Pelado
Lucha Greco / Greco-Roman Wrestling

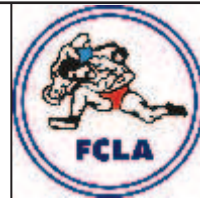

Clasificación Final / Final Standings

66 kg / 66 kg

Lugar Place	Nombre Name	Equipo Team	Puntos Points
1	MULEN, Pedro Isaac	CUB	
2	STABLER, Frank	GER	
3	SCHLATTER, C.P	USA	
3	MARTINEZ, Miguel	CUB	
5	THOMMESEN, Marius	NOR	
5	CORRIGA, Tiziano	ITA	
7	MAÑON, Jhomaylen	DOM	
8	MAGNI, Ricardo	ITA	



43 Torneo Internacion Granma - Cerro Pelado
 43 International Tournament Granma - Cerro Pelado
Lucha Greco / Greco-Roman Wrestling
 Hombres / Men



Resultados 74 kg / Results 74 kg (13/02/2012)

1/8

1/4

1/2

FINAL

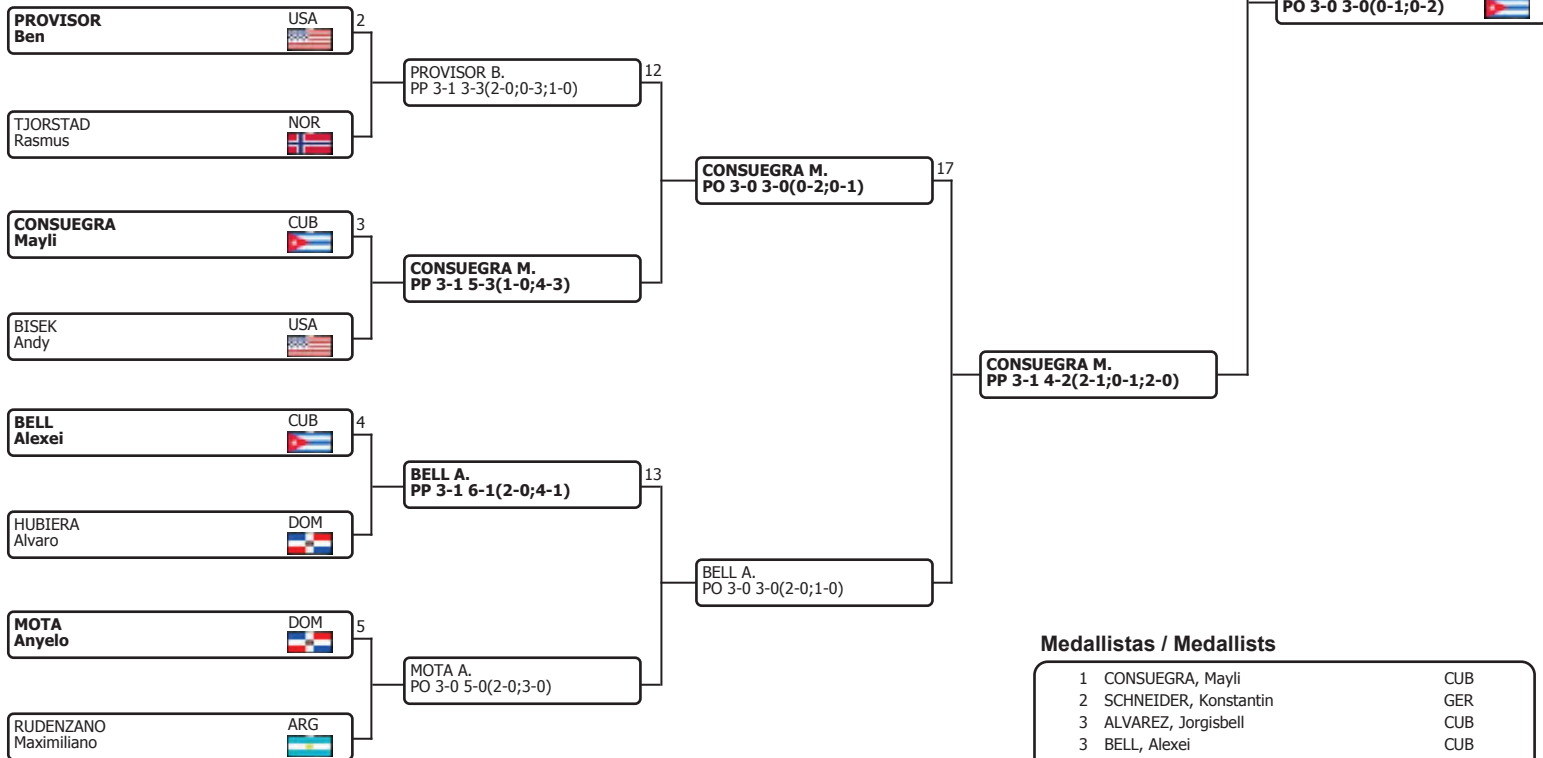
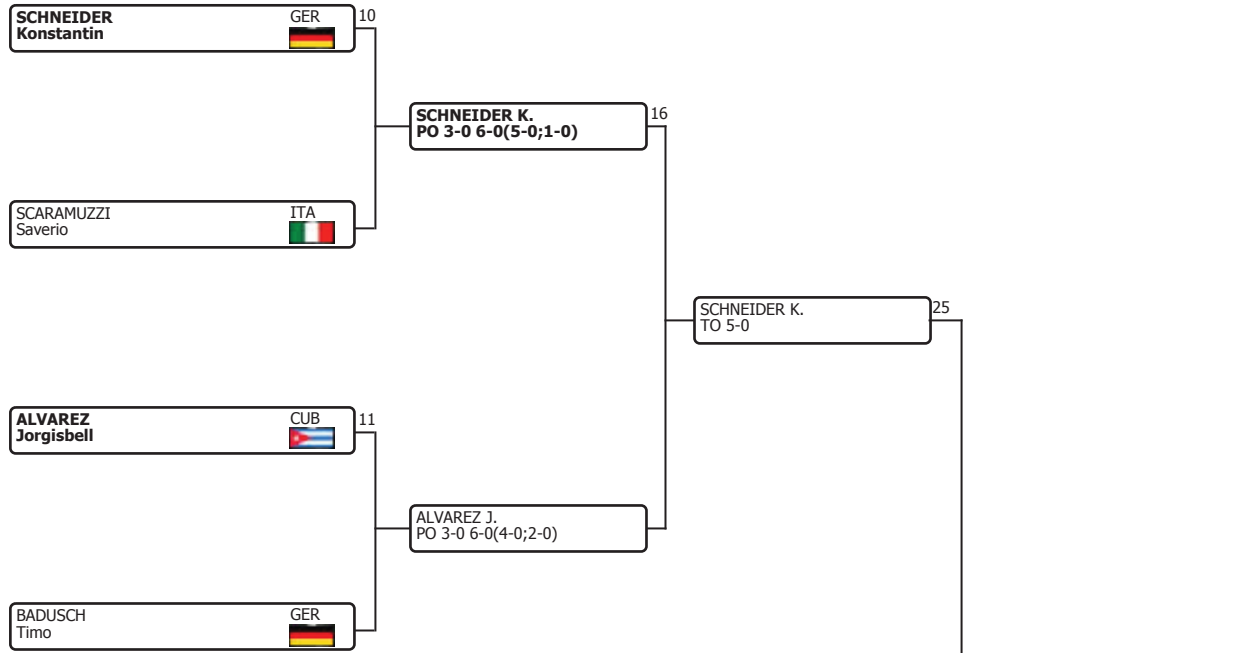

Medallistas / Medallists

1	CONSUEGRA, Mayli	CUB
2	SCHNEIDER, Konstantin	GER
3	ALVAREZ, Jorgisbell	CUB
3	BELL, Alexei	CUB

TO - Victoria por pegada, Lesión, Retirada / Victory by fall, Injury, Withdrawal ST - Gran superioridad / Great superiority SP - Superioridad técnica / Technical superiority NP - No presentación / Forfeit
 PP - Decisión por ptos, perdedor con ptos / Decision by points, the loser with points PO - Decisión por puntos, perdedor sin ptos / Decision by points, the loser without points EV - Descalificación / Disqualification
 EX - 3 advertencias "0" / 3 cautions "0" E2 - Descalificación de ambos luchadores / Both wrestlers disqual



43 Torneo Internacion Granma - Cerro Pelado
 43 International Tournament Granma - Cerro Pelado
Lucha Greco / Greco-Roman Wrestling
 Hombres / Men



Resultados 74 kg / Results 74 kg (13/02/2012)

1/4

1/2

FINAL

Repechage 1

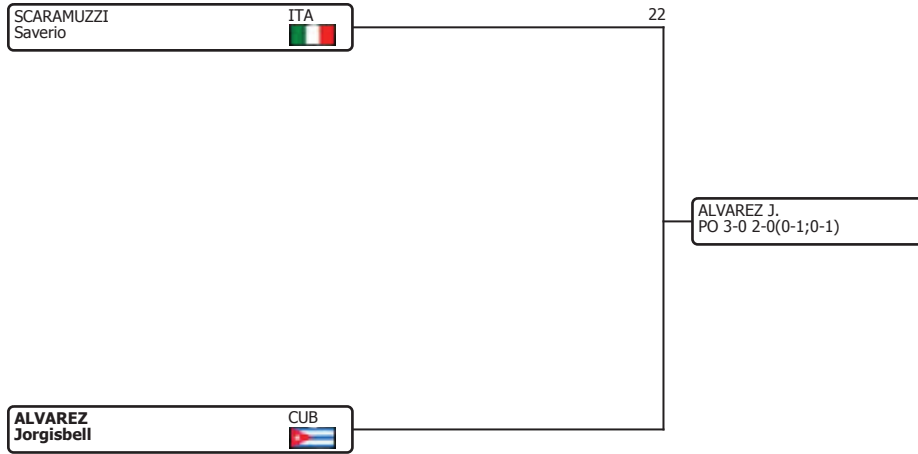

Repechage 2

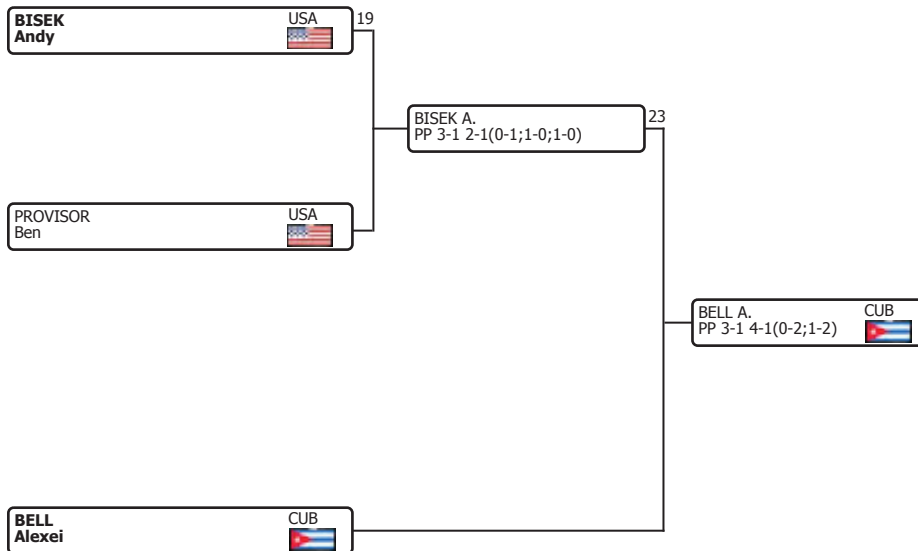

TO - Victoria por pegada, Lesión, Retirada / Victory by fall, Injury, Withdrawal ST - Gran superioridad / Great superiority SP - Superioridad técnica / Technical superiority NP - No presentación / Forfeit
 PP - Decisión por ptos, perdedor con ptos / Decision by points, the loser with points PO - Decisión por puntos, perdedor sin ptos / Decision by points, the loser without points EV - Descalificación / Disqualification
 EX - 3 advertencias "0" / 3 cautions "0" E2 - Descalificación de ambos luchadores / Both wrestlers disqual



43 Torneo Internacion Granma - Cerro Pelado
43 International Tournament Granma - Cerro Pelado
Lucha Greco / Greco-Roman Wrestling

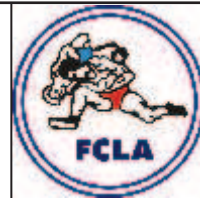

Clasificación Final / Final Standings

74 kg / 74 kg

Lugar Place	Nombre Name	Equipo Team	Puntos Points
1	CONSUEGRA, Mayli	CUB	
2	SCHNEIDER, Konstantin	GER	
3	ALVAREZ, Jorgisbell	CUB	
3	BELL, Alexei	CUB	
5	BISEK, Andy	USA	
5	SCARAMUZZI, Saverio	ITA	
7	PROVISOR, Ben	USA	
8	MOTA, Anyelo	DOM	
9	BADUSCH, Timo	GER	
10	TJORSTAD, Rasmus	NOR	
11	HUBIERA, Alvaro	DOM	
12	RUDENZANO, Maximiliano	ARG	



43 Torneo Internacion Granma - Cerro Pelado
 43 International Tournament Granma - Cerro Pelado
Lucha Greco / Greco-Roman Wrestling
 Hombres / Men



Resultados 84 kg / Results 84 kg (12/02/2012)

1/8

1/4

1/2

FINAL



Medallistas / Medallists

1	SHOREY, Pablo	CUB
2	HOLM, Jordan	USA
3	BETTS, Chas	USA
3	MINGUZZI, Andrea	ITA

TO - Victoria por pegada, Lesión, Retirada / Victory by fall, Injury, Withdrawal ST - Gran superioridad / Great superiority SP - Superioridad técnica / Technical superiority NP - No presentación / Forfeit
 PP - Decisión por pto., perdedor con pto. / Decision by points, the loser with points PO - Decisión por puntos, perdedor sin pto. / Decision by points, the loser without points EV - Descalificación / Disqualification
 EX - 3 advertencias "0" / 3 cautions "0" E2 - Descalificación de ambos luchadores / Both wrestlers disqual



43 Torneo Internacion Granma - Cerro Pelado
 43 International Tournament Granma - Cerro Pelado
Lucha Greco / Greco-Roman Wrestling
 Hombres / Men



Resultados 84 kg / Results 84 kg (12/02/2012)

1/4

1/2

FINAL

Repechage 1

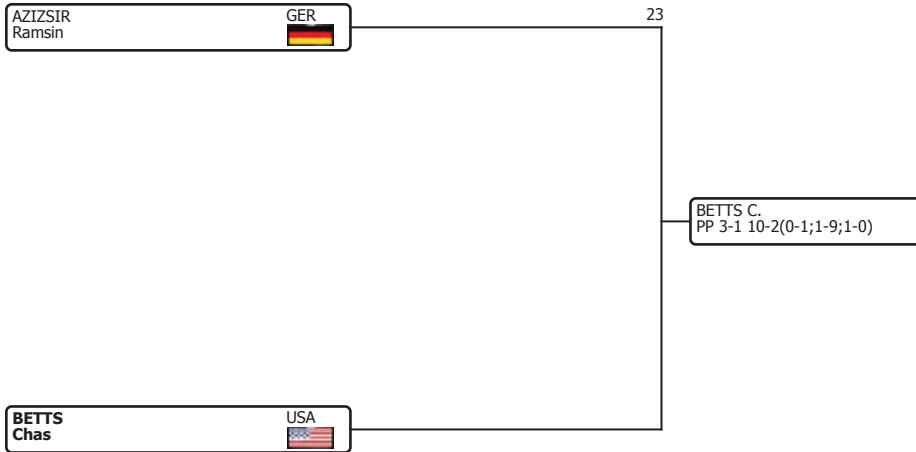

Repechage 2

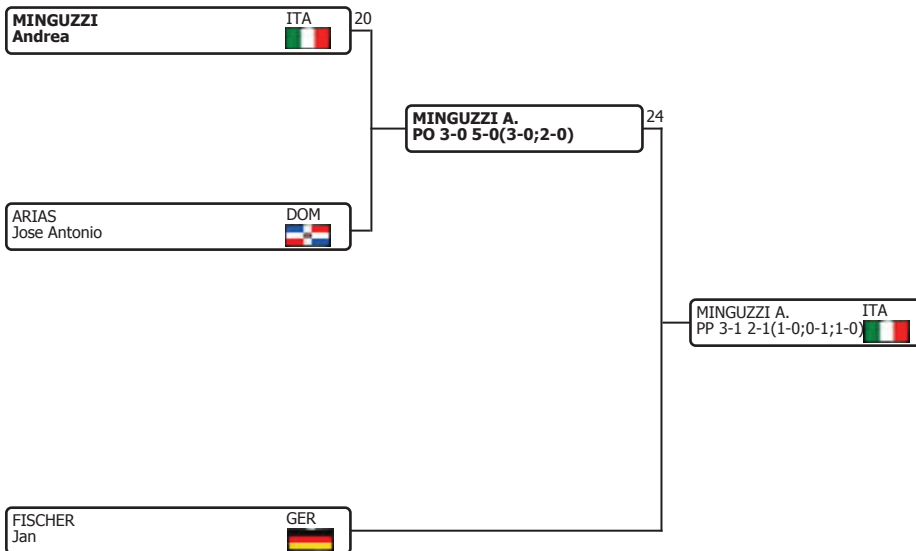

TO - Victoria por pegada, Lesión, Retirada / Victory by fall, Injury, Withdrawal ST - Gran superioridad / Great superiority SP - Superioridad técnica / Technical superiority NP - No presentación / Forfeit
 PP - Decisión por ptos, perdedor con ptos / Decision by points, the loser with points PO - Decisión por puntos, perdedor sin ptos / Decision by points, the loser without points EV - Descalificación / Disqualification
 EX - 3 advertencias "0" / 3 cautions "0" E2 - Descalificación de ambos luchadores / Both wrestlers disqual



43 Torneo Internacion Granma - Cerro Pelado
43 International Tournament Granma - Cerro Pelado
Lucha Greco / Greco-Roman Wrestling

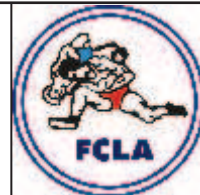

Clasificación Final / Final Standings

84 kg / 84 kg

Lugar Place	Nombre Name	Equipo Team	Puntos Points
1	SHOREY, Pablo	CUB	
2	HOLM, Jordan	USA	
3	BETTS, Chas	USA	
3	MINGUZZI, Andrea	ITA	
5	AZIZSIR, Ramsin	GER	
5	FISCHER, Jan	GER	
7	VERA, Alan	CUB	
8	ARIAS, Jose Antonio	DOM	
9	GOMEZ, Joan Antonio	DOM	
10	MATUZEVICIUS, Julius	LTU	
11	SCIBILIA, Vincenzo	ITA	



43 Torneo Internacion Granma - Cerro Pelado
 43 International Tournament Granma - Cerro Pelado
Lucha Greco / Greco-Roman Wrestling
 Hombres / Men



Resultados 96 kg / Results 96 kg (12/02/2012)

1/8

1/4

1/2

FINAL



TO - Victoria por pegada, Lesión, Retirada / Victory by fall, Injury, Withdrawal ST - Gran superioridad / Great superiority SP - Superioridad técnica / Technical superiority NP - No presentación / Forfeit
 PP - Decisión por ptos, perdedor con ptos / Decision by points, the loser with points PO - Decisión por puntos, perdedor sin ptos / Decision by points, the loser without points EV - Descalificación / Disqualification
 EX - 3 advertencias "0" / 3 cautions "0" E2 - Descalificación de ambos luchadores / Both wrestlers disqual



43 Torneo Internacion Granma - Cerro Pelado
 43 International Tournament Granma - Cerro Pelado
Lucha Greco / Greco-Roman Wrestling
 Hombres / Men



Resultados 96 kg / Results 96 kg (12/02/2012)

1/4

1/2

FINAL

Repechage 1

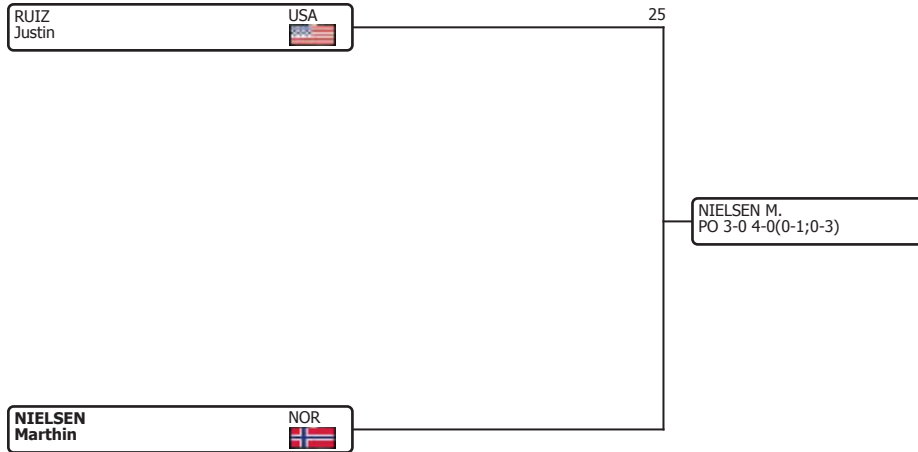

Repechage 2

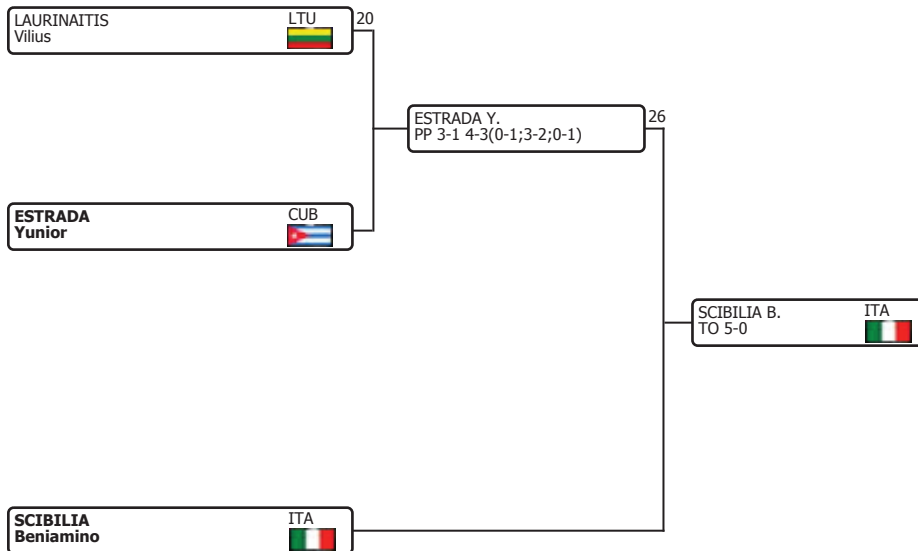

TO - Victoria por pegada, Lesión, Retirada / Victory by fall, Injury, Withdrawal ST - Gran superioridad / Great superiority SP - Superioridad técnica / Technical superiority NP - No presentación / Forfeit
 PP - Decisión por ptos, perdedor con ptos / Decision by points, the loser with points PO - Decisión por puntos, perdedor sin ptos / Decision by points, the loser without points EV - Descalificación / Disqualification
 EX - 3 advertencias "0" / 3 cautions "0" E2 - Descalificación de ambos luchadores / Both wrestlers disqual



43 Torneo Internacion Granma - Cerro Pelado
43 International Tournament Granma - Cerro Pelado
Lucha Greco / Greco-Roman Wrestling

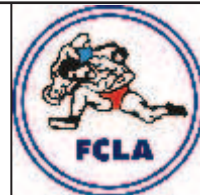

Clasificación Final / Final Standings

96 kg / 96 kg

Lugar Place	Nombre Name	Equipo Team	Puntos Points
1	LUGO, Yasmani	CUB	
2	ENGLISH, Mirko	GER	
3	SCIBILIA, Beniamino	ITA	
3	NIELSEN, Marthin	NOR	
5	ESTRADA, Yunion	CUB	
5	RUIZ, Justin	USA	
7	LAURINAITIS, Vilius	LTU	
8	MAIER, Yuri	ARG	
9	TIMONCINI, Daigoro	ITA	
10	HASSLER, Oliver	GER	



43 Torneo Internacion Granma - Cerro Pelado
 43 International Tournament Granma - Cerro Pelado
Lucha Greco / Greco-Roman Wrestling
 Hombres / Men



Resultados 120 kg / Results 120 kg (12/02/2012)

1/4

1/2

FINAL

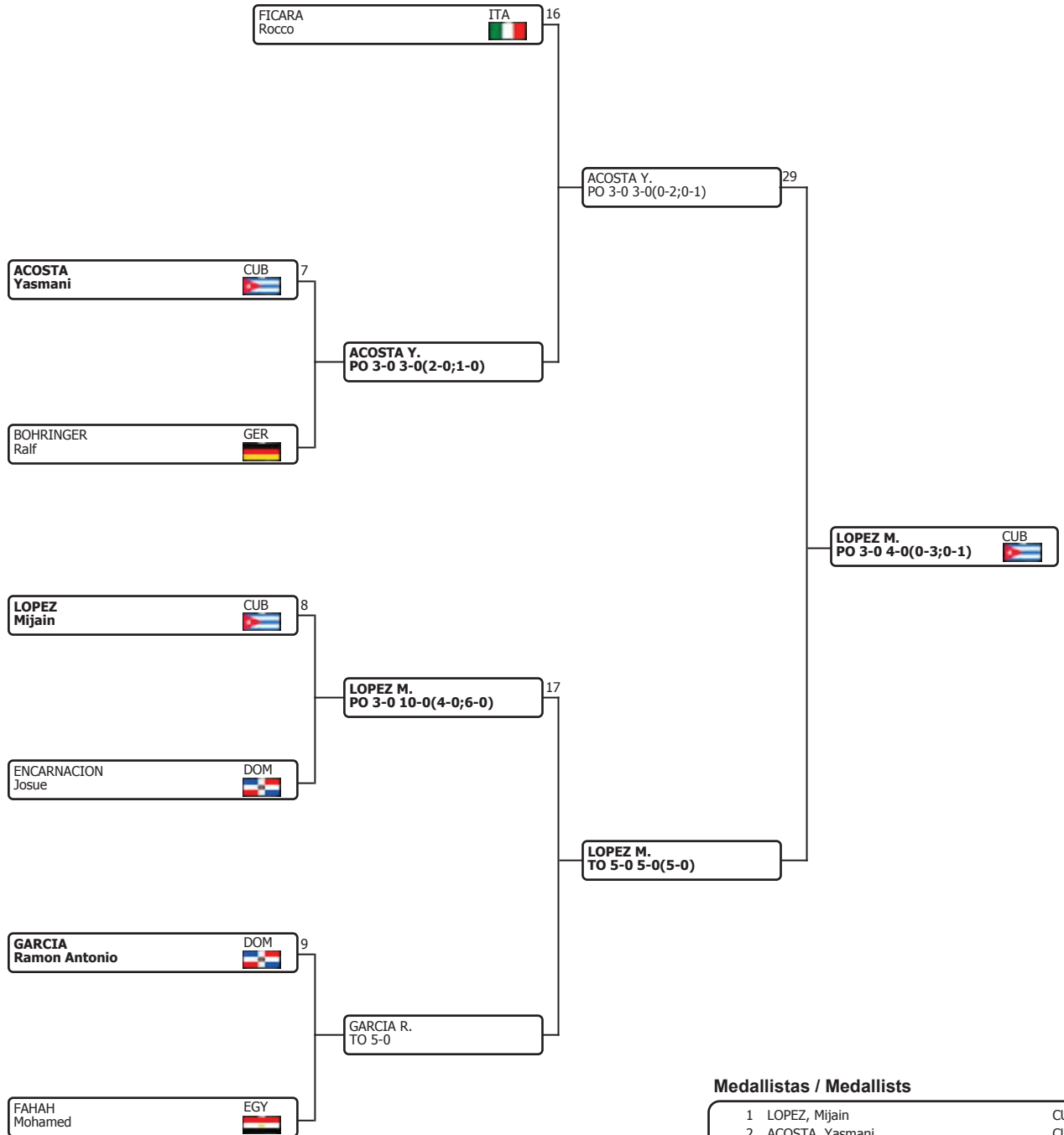

Medallistas / Medallists

1	LOPEZ, Mijain	CUB
2	ACOSTA, Yasmani	CUB
3	BOHRINGER, Ralf	GER
3	GARCIA, Ramon Antonio	DOM

TO - Victoria por pegada, Lesión, Retirada / Victory by fall, Injury, Withdrawal ST - Gran superioridad / Great superiority SP - Superioridad técnica / Technical superiority NP - No presentación / Forfeit
 PP - Decisión por ptos, perdedor con ptos / Decision by points, the loser with points PO - Decisión por puntos, perdedor sin ptos / Decision by points, the loser without points EV - Descalificación / Disqualification
 EX - 3 advertencias "0" / 3 cautions "0" E2 - Descalificación de ambos luchadores / Both wrestlers disqual



43 Torneo Internacion Granma - Cerro Pelado
 43 International Tournament Granma - Cerro Pelado
Lucha Greco / Greco-Roman Wrestling
 Hombres / Men



Resultados 120 kg / Results 120 kg (12/02/2012)

1/2

FINAL

Repechage 1



Repechage 2

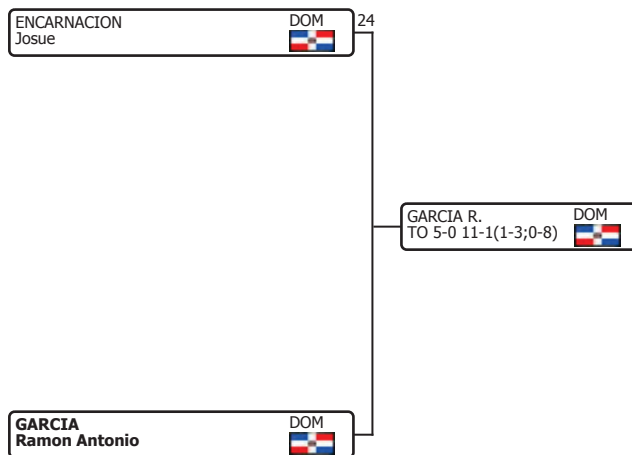



43 Torneo Internacion Granma - Cerro Pelado
43 International Tournament Granma - Cerro Pelado
Lucha Greco / Greco-Roman Wrestling

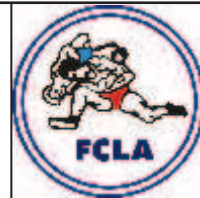

Clasificación Final / Final Standings

120 kg / 120 kg

Lugar Place	Nombre Name	Equipo Team	Puntos Points
1	LOPEZ, Mijain	 CUB	
2	ACOSTA, Yasmani	 CUB	
3	BOHRINGER, Ralf	 GER	
3	GARCIA, Ramon Antonio	 DOM	
5	ENCARNACION, Josue	 DOM	
5	FICARA, Rocco	 ITA	
7	FAHAH, Mohamed	 EGY	



43 Torneo Internacion Granma - Cerro Pelado
43 International Tournament Granma - Cerro Pelado
Lucha Greco / Greco-Roman Wrestling

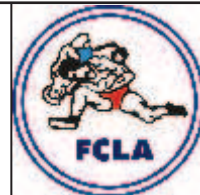

Medallas por Equipos / Medals by Teams

Equipos Teams	ORO GOLD	PLATA SILVER	BRONCE BRONZE	TOTAL
CUB Cuba	7	2	3	12
GER Alemania	0	4	2	6
USA Estados Unidos	0	1	2	3
NOR Noruega	0	0	3	3
ITA Italia	0	0	2	2
DOM Republica Dominicana	0	0	1	1
ECU Ecuador	0	0	1	1
Totales / Summary	7	7	14	28



43 Torneo Internacional Granma - Cerro Pelado
43 International Tournament Granma - Cerro Pelado

Lucha Libre / Free Style Wrestling

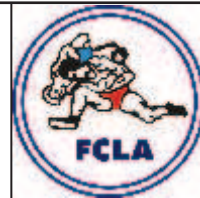

Participantes por Categoría / Participants by Categories

**48 kg / 48 kg
Mujeres / Women**

Nombre Name	Equipo Team	Fecha Nac. Birthdate	Talla (cm) Height	Peso (Kg) Weight
BERMUDEZ, Patricia	ARG			
MELITA, Eluney	ARG			
SANZ, Aray	CUB			
TOAZA, Katiuska	ECU			

**51 kg / 51 kg
Mujeres / Women**

Nombre Name	Equipo Team	Fecha Nac. Birthdate	Talla (cm) Height	Peso (Kg) Weight
BROWN, Vanessa	CAN			
HALEY, Genevieve	CAN			
MAC DONALD, Jessica	CAN			

**55 kg / 55 kg
Mujeres / Women**

Nombre Name	Equipo Team	Fecha Nac. Birthdate	Talla (cm) Height	Peso (Kg) Weight
ACEA, Idirmis	CUB			
DEL VALLE, Yamilka	CUB			
GONZALEZ, Romina	ARG			
LEVERDURE, Brittanee	CAN			

**59 kg / 59 kg
Mujeres / Women**

Nombre Name	Equipo Team	Fecha Nac. Birthdate	Talla (cm) Height	Peso (Kg) Weight
FAZZARI, Michelle	CAN			
GERHART, Amanda	CAN			
RAMIREZ, Lisandra	CUB			

**63 kg / 63 kg
Mujeres / Women**

Nombre Name	Equipo Team	Fecha Nac. Birthdate	Talla (cm) Height	Peso (Kg) Weight
LAPPAGE, Danielle	CAN			
VAZQUEZ, Luz Clara	ARG			



43 Torneo Internacional Granma - Cerro Pelado
43 International Tournament Granma - Cerro Pelado
Lucha Libre / Free Style Wrestling

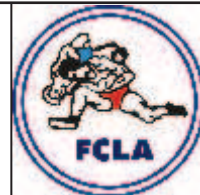

Participantes por Categoría / Participants by Categories

67 kg / 67 kg
Mujeres / Women

Nombre Name	Equipo Team	Fecha Nac. Birthdate	Talla (cm) Height	Peso (Kg) Weight
BUYDENS, Megan	CAN			
DE ARMAS, Candida	CUB			

72 kg / 72 kg
Mujeres / Women

Nombre Name	Equipo Team	Fecha Nac. Birthdate	Talla (cm) Height	Peso (Kg) Weight
AKUFFO, Ohenewa	CAN			
HECHEVARRIA, Lisset	CUB			
WIEBE, Erica	CAN			



43 Torneo Internacional Granma - Cerro Pelado
 43 International Tournament Granma - Cerro Pelado
Lucha Libre / Free Style Wrestling
 Mujeres / Women



Resultados 48 kg / Results 48 kg (13/02/2012)

	I	II	III	Vict	P Clasif.	P Tec.
1	ECU TOAZA, Katiuska	[2] 1 [3] 3 [4] 1		1	5	10
	PP 3	PP 4	PP 3			
2	ARG BERMUDEZ, Patricia	[1] 3 [4] 3 [3] 3		3	9	12
	PP 2	PP 5	PO 5			
3	ARG MELITA, Eluney	[4] 1 [1] 1 [2] 0		0	2	2
	PP 1	PP 1	PO 0			
4	CUB SANZ, Aray	[3] 3 [2] 1 [1] 3		2	7	14
	PP 6	PP 4	PP 4			

Clasificación Final / Final Standings

Lugar Rank	Equipo Team	Nombre Name
1	ARG	BERMUDEZ, Patricia
2	CUB	SANZ, Aray
3	ECU	TOAZA, Katiuska
4	ARG	MELITA, Eluney

Leyenda / Legend

[A]	PC
[D]	PT

[A]: Adversario / Adversary PC: Puntos de Clasificación / Classification Points
 [D]: Decisión / Decision PT: Puntos Técnicos / Technical Points

TO - Victoria por pegada, Lesión, Retirada / Victory by fall, injury, Withdrawal ST - Gran superioridad / Great superiority SP - Superioridad técnica / Technical superiority NP - No presentación / Forfeit
 PP - Decisión, perdedor con ptos / Decision by points, the loser with points PO - Decisión, perdedor sin ptos / Decision by points, the loser without points EV - Descalificación / Disqualification
 EX - 3 advertencias "0" / 3 cautions "0" E2 - Descalificación de ambos luchadores / Both wrestlers disqual



43 Torneo Internacional Granma - Cerro Pelado
43 International Tournament Granma - Cerro Pelado
Lucha Libre / Free Style Wrestling



Clasificación Final / Final Standings

48 kg / 48 kg
Mujeres / Women

Lugar Place	Nombre Name	Equipo Team	Puntos Points
1	BERMUDEZ, Patricia	 ARG	
2	SANZ, Aray	 CUB	
3	TOAZA, Katiuska	 ECU	
4	MELITA, Eluney	 ARG	



43 Torneo Internacional Granma - Cerro Pelado
 43 International Tournament Granma - Cerro Pelado
Lucha Libre / Free Style Wrestling
 Mujeres / Women



Resultados 51 kg / Results 51 kg (13/02/2012)

	I	II	III	Vict	P Clasif.	P Tec.
1	CAN MAC DONALD, Jessica	3 [3]	5	2	8	6
	PP 4	TO 2				
2	CAN HALEY, Genevieve	1	[3] 1	0	2	3
	PP 2		PP 1			
3	CAN BROWN, Vanessa	[1] 0	[2] 3	1	3	15
		TO 5	PP 10			

Clasificación Final / Final Standings

Lugar Rank	Equipo Team	Nombre Name
1	CAN	MAC DONALD, Jessica
2	CAN	BROWN, Vanessa
3	CAN	HALEY, Genevieve

Leyenda / Legend

[A]	PC
D	PT

[A]: Adversario / Adversary PC: Puntos de Clasificación / Classification Points
 D : Decisión / Decision PT: Puntos Técnicos / Technical Points

TO - Victoria por pegada, Lesión, Retirada / Victory by fall, injury, Withdrawal ST - Gran superioridad / Great superiority SP - Superioridad técnica / Technical superiority NP - No presentación / Forfeit
 PP - Decisión, perdedor con ptos / Decision by points, the loser with points PO - Decisión, perdedor sin ptos / Decision by points, the loser without points EV - Descalificación / Disqualification
 EX - 3 advertencias "0" / 3 cautions "0" E2 - Descalificación de ambos luchadores / Both wrestlers disqual



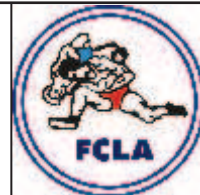

43 Torneo Internacional Granma - Cerro Pelado
43 International Tournament Granma - Cerro Pelado
Lucha Libre / Free Style Wrestling



Clasificación Final / Final Standings

51 kg / 51 kg
Mujeres / Women

Lugar Place	Nombre Name	Equipo Team	Puntos Points
1	MAC DONALD, Jessica	 CAN	
2	BROWN, Vanessa	 CAN	
3	HALEY, Genevieve	 CAN	



43 Torneo Internacional Granma - Cerro Pelado
 43 International Tournament Granma - Cerro Pelado
Lucha Libre / Free Style Wrestling
 Mujeres / Women



Resultados 55 kg / Results 55 kg (13/02/2012)

	I	II	III	Vict	P Clasif.	P Tec.
1	CAN LEVERDURE, Brittane	[2] 5 [3] 1 [4] 3		2	9	10
	TO 3	PP 5	PP 2			
2	ARG GONZALEZ, Romina	[1] 0 [4] 0 [3] 0		0	0	0
	TO 0	TO 0	TO 0			
3	CUB DEL VALLE, Yamilka	[4] 3 [1] 3 [2] 5		3	11	8
	PO 2	PP 6	TO 0			
4	CUB ACEA, Idirmis	[3] 0 [2] 5 [1] 1		1	6	5
	PO 0	TO 4	PP 1			

Clasificación Final / Final Standings

Lugar Rank	Equipo Team	Nombre Name
1	CUB	DEL VALLE, Yamilka
2	CAN	LEVERDURE, Brittane
3	CUB	ACEA, Idirmis
4	ARG	GONZALEZ, Romina

Leyenda / Legend

[A]	PC
[D]	PT

[A]: Adversario / Adversary PC: Puntos de Clasificación / Classification Points
 [D]: Decisión / Decision PT: Puntos Técnicos / Technical Points

TO - Victoria por pagada, Lesión, Retirada / Victory by fall, Injury, Withdrawal ST - Gran superioridad / Great superiority SP - Superioridad técnica / Technical superiority NP - No presentación / Forfeit
 PP - Decisión, perdedor con ptos / Decision by points, the loser with points PO - Decisión, perdedor sin ptos / Decision by points, the loser without points EV - Descalificación / Disqualification
 EX - 3 advertencias "0" / 3 cautions "0" E2 - Descalificación de ambos luchadores / Both wrestlers disqual



43 Torneo Internacional Granma - Cerro Pelado
43 International Tournament Granma - Cerro Pelado
Lucha Libre / Free Style Wrestling

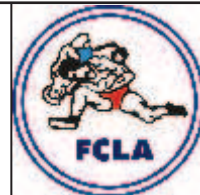

Clasificación Final / Final Standings

55 kg / 55 kg
Mujeres / Women

Lugar Place	Nombre Name	Equipo Team	Puntos Points
1	DEL VALLE, Yamilka	 CUB	
2	LEVERDURE, Brittane	 CAN	
3	ACEA, Idirmis	 CUB	
4	GONZALEZ, Romina	 ARG	



43 Torneo Internacional Granma - Cerro Pelado
 43 International Tournament Granma - Cerro Pelado
Lucha Libre / Free Style Wrestling
 Mujeres / Women



Resultados 59 kg / Results 59 kg (14/02/2012)

	I	II	III	Vict	P Clasif.	P Tec.
1	CUB RAMIREZ, Lisandra	[2] 1 [3] 0		0	1	2
	PP 2	PO 0				
2	CAN FAZZARI, Michelle	[1] 3	[3] 3	2	6	9
	PP 6		PO 3			
3	CAN GERHART, Amanda		[1] 3 [2] 0	1	3	5
			PO 5			PO 0

Clasificación Final / Final Standings

Lugar Rank	Equipo Team	Nombre Name
1	CAN	FAZZARI, Michelle
2	CAN	GERHART, Amanda
3	CUB	RAMIREZ, Lisandra

Leyenda / Legend

[A]	PC
D	PT

[A]: Adversario / Adversary PC: Puntos de Clasificación / Classification Points
 D : Decisión / Decision PT: Puntos Técnicos / Technical Points

TO - Victoria por pegada, Lesión, Retirada / Victory by fall, injury, Withdrawal ST - Gran superioridad / Great superiority SP - Superioridad técnica / Technical superiority NP - No presentación / Forfeit
 PP - Decisión, perdedor con ptos / Decision by points, the loser with points PO - Decisión, perdedor sin ptos / Decision by points, the loser without points EV - Descalificación / Disqualification
 EX - 3 advertencias "0" / 3 cautions "0" E2 - Descalificación de ambos luchadores / Both wrestlers disqual



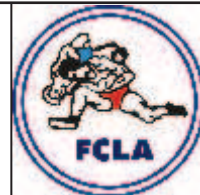

43 Torneo Internacional Granma - Cerro Pelado
43 International Tournament Granma - Cerro Pelado
Lucha Libre / Free Style Wrestling



Clasificación Final / Final Standings

59 kg / 59 kg
Mujeres / Women

Lugar Place	Nombre Name	Equipo Team	Puntos Points
1	FAZZARI, Michelle	 CAN	
2	GERHART, Amanda	 CAN	
3	RAMIREZ, Lisandra	 CUB	



43 Torneo Internacional Granma - Cerro Pelado
 43 International Tournament Granma - Cerro Pelado
Lucha Libre / Free Style Wrestling
 Mujeres / Women



Resultados 63 kg / Results 63 kg (14/02/2012)

	I	Vict	P Clasif.	P Tec.	
1	ARG VAZQUEZ, Luz Clara	3	1	3	5
	PP	5			
2	CAN LAPPAGE, Danielle	[1] 1	0	1	1
	PP	1			

Clasificación Final / Final Standings

Lugar Rank	Equipo Team	Nombre Name
1	ARG	VAZQUEZ, Luz Clara
2	CAN	LAPPAGE, Danielle

Leyenda / Legend

[A]	PC
D	PT

[A]: Adversario / Adversary PC: Puntos de Clasificación / Classification Points
 D : Decisión / Decision PT: Puntos Técnicos / Technical Points

TO - Victoria por pegada, Lesión, Retirada / Victory by fall, injury, Withdrawal ST - Gran superioridad / Great superiority SP - Superioridad técnica / Technical superiority NP - No presentación / Forfeit
 PP - Decisión, perdedor con ptos / Decision by points, the loser with points PO - Decisión, perdedor sin ptos / Decision by points, the loser without points EV - Descalificación / Disqualification
 EX - 3 advertencias "0" / 3 cautions "0" E2 - Descalificación de ambos luchadores / Both wrestlers disqualification



43 Torneo Internacional Granma - Cerro Pelado
43 International Tournament Granma - Cerro Pelado
Lucha Libre / Free Style Wrestling

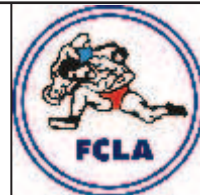

Clasificación Final / Final Standings

63 kg / 63 kg
Mujeres / Women

Lugar Place	Nombre Name	Equipo Team	Puntos Points
1	VAZQUEZ, Luz Clara	 ARG	
2	LAPPAGE, Danielle	 CAN	



43 Torneo Internacional Granma - Cerro Pelado
 43 International Tournament Granma - Cerro Pelado
Lucha Libre / Free Style Wrestling
 Mujeres / Women



Resultados 67 kg / Results 67 kg (14/02/2012)

	I	Vict	P Clasif.	P Tec.
1	CUB DE ARMAS, Candida	[2]	3	1 3 11
	PP	11		
2	CAN BUYDENS, Megan	[1]	1	0 1 2
	PP	2		

Clasificación Final / Final Standings

Lugar Rank	Equipo Team	Nombre Name
1	CUB	DE ARMAS, Candida
2	CAN	BUYDENS, Megan

Leyenda / Legend

[A]	PC
D	PT

[A]: Adversario / Adversary PC: Puntos de Clasificación / Classification Points
 D : Decisión / Decision PT: Puntos Técnicos / Technical Points

TO - Victoria por pegada, Lesión, Retirada / Victory by fall, injury, Withdrawal ST - Gran superioridad / Great superiority SP - Superioridad técnica / Technical superiority NP - No presentación / Forfeit
 PP - Decisión, perdedor con ptos / Decision by points, the loser with points PO - Decisión, perdedor sin ptos / Decision by points, the loser without points EV - Descalificación / Disqualification
 EX - 3 advertencias "0" / 3 cautions "0" E2 - Descalificación de ambos luchadores / Both wrestlers disqual



43 Torneo Internacional Granma - Cerro Pelado
43 International Tournament Granma - Cerro Pelado
Lucha Libre / Free Style Wrestling

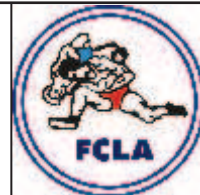

Clasificación Final / Final Standings

67 kg / 67 kg
Mujeres / Women

Lugar Place	Nombre Name	Equipo Team	Puntos Points
1	DE ARMAS, Candida	 CUB	
2	BUYDENS, Megan	 CAN	



43 Torneo Internacional Granma - Cerro Pelado
 43 International Tournament Granma - Cerro Pelado
Lucha Libre / Free Style Wrestling
 Mujeres / Women



Resultados 72 kg / Results 72 kg (14/02/2012)

	I	II	III	Vict	P Clasif.	P Tec.
1	CAN AKUFFO, Ohenewa	0 [3] 0		0	0	0
	TO	0 PO 0				
2	CAN WIEBE, Erica		[3] 3	2	8	11
	TO	4	PO 7			
3	CUB HECHEVARRIA, Lisset		[1] 3 [2] 0	1	3	6
		PO	6 PO 0			

Clasificación Final / Final Standings

Lugar Rank	Equipo Team	Nombre Name
1	CAN	WIEBE, Erica
2	CUB	HECHEVARRIA, Lisset
3	CAN	AKUFFO, Ohenewa

Leyenda / Legend

[A]	PC
D	PT

[A]: Adversario / Adversary PC: Puntos de Clasificación / Classification Points
 D : Decisión / Decision PT: Puntos Técnicos / Technical Points

TO - Victoria por pagada, Lesión, Retirada / Victory by fall, injury, withdrawal ST - Gran superioridad / Great superiority SP - Superioridad técnica / Technical superiority NP - No presentación / Forfeit
 PP - Decisión, perdedor con ptos / Decision by points, the loser with points PO - Decisión, perdedor sin ptos / Decision by points, the loser without points EV - Descalificación / Disqualification
 EX - 3 advertencias "0" / 3 cautions "0" E2 - Descalificación de ambos luchadores / Both wrestlers disqual



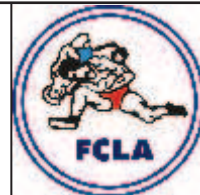

43 Torneo Internacional Granma - Cerro Pelado
43 International Tournament Granma - Cerro Pelado
Lucha Libre / Free Style Wrestling



Clasificación Final / Final Standings

72 kg / 72 kg
Mujeres / Women

Lugar Place	Nombre Name	Equipo Team	Puntos Points
1	WIEBE, Erica	 CAN	
2	HECHEVARRIA, Lisset	 CUB	
3	AKUFFO, Ohenewa	 CAN	