

Competition Sheet

Feuille de compétition

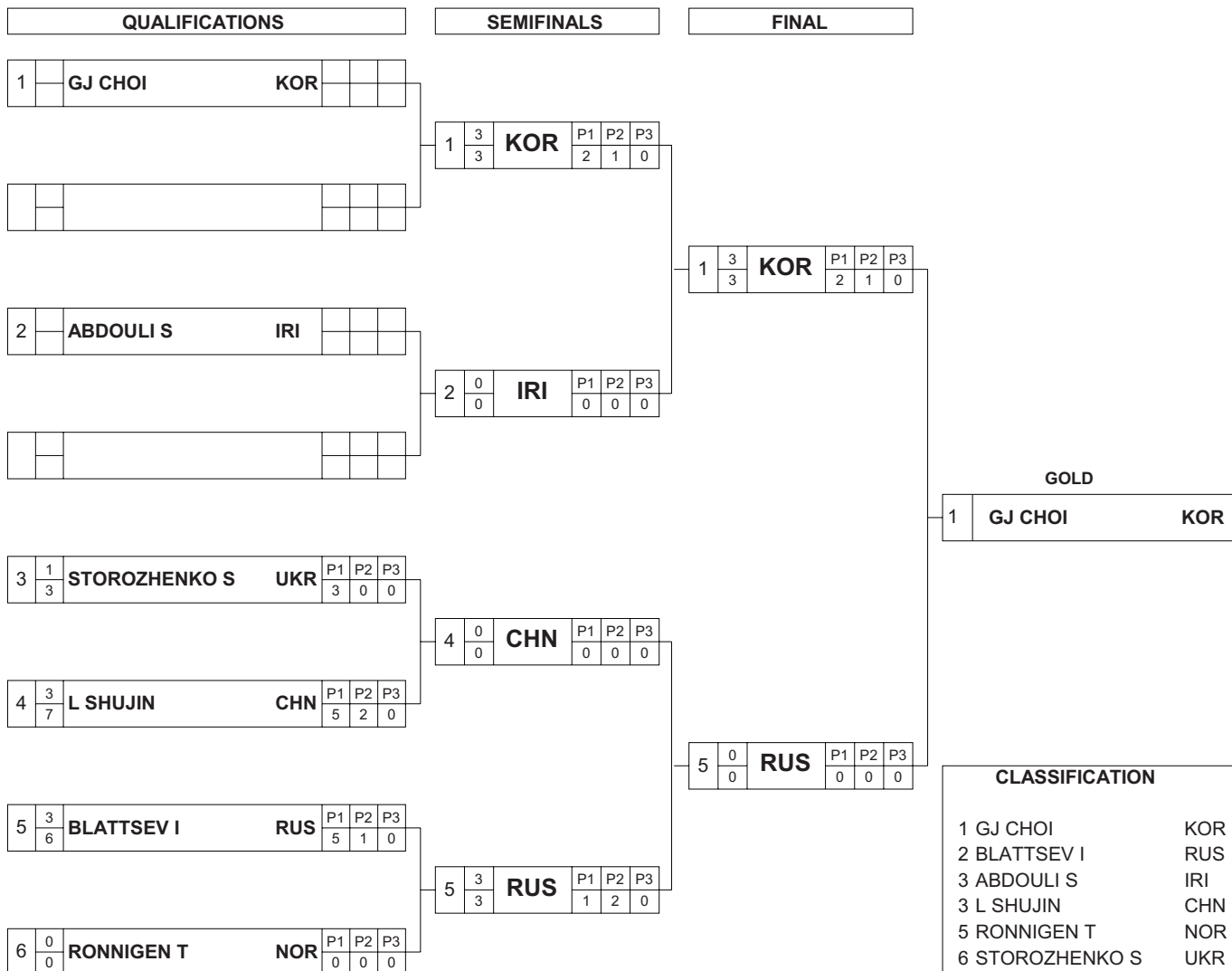

REPECHAGE

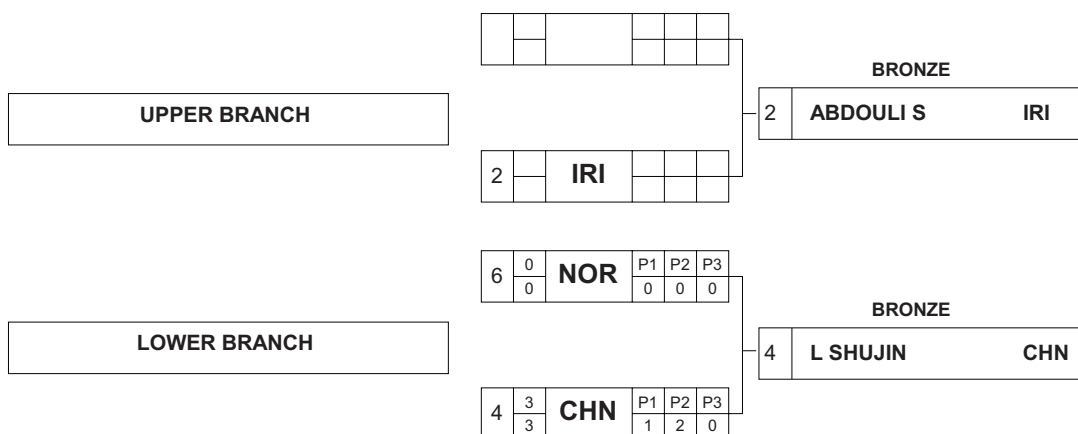

Competition Sheet

Feuille de compétition

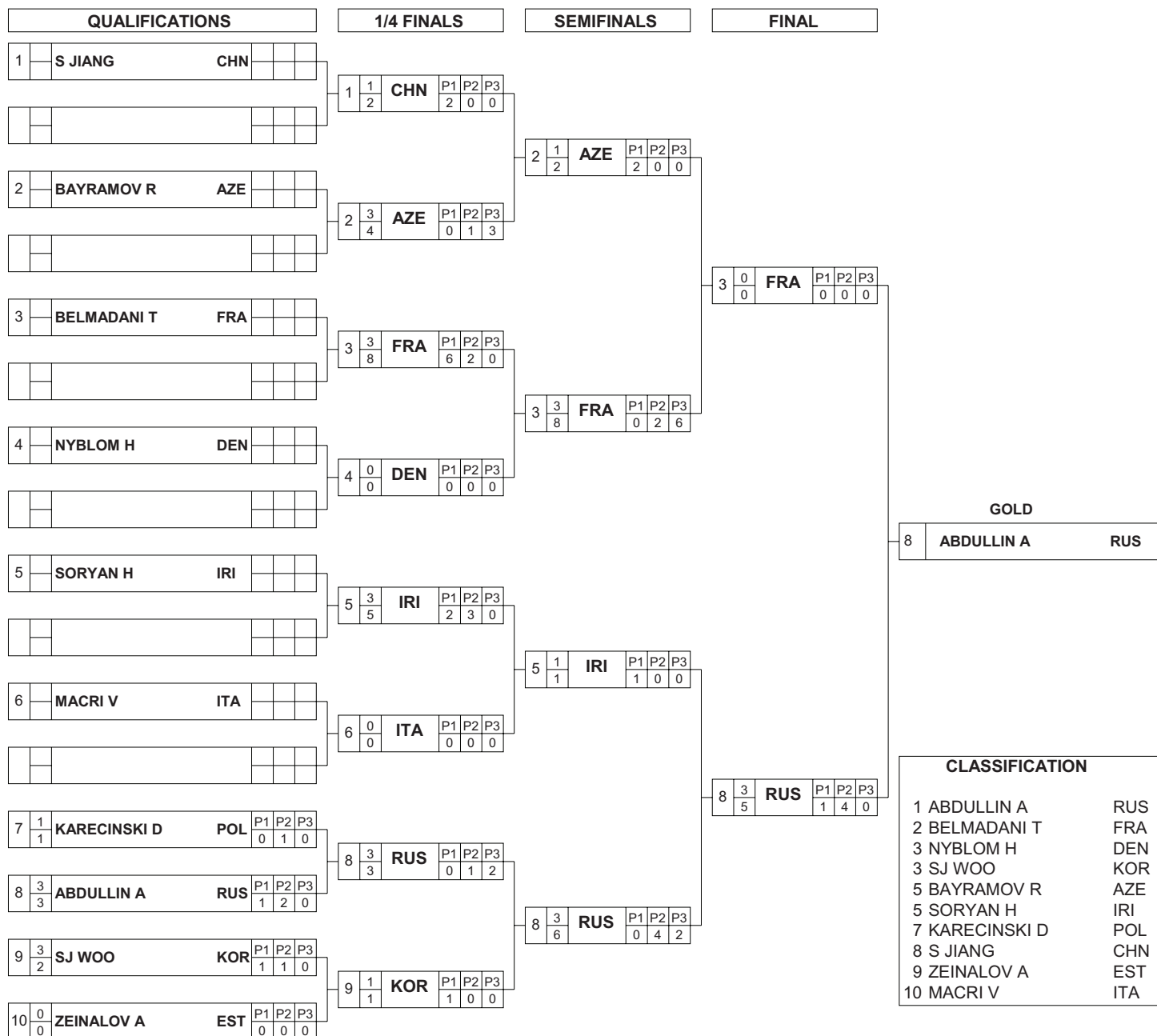

Competition Sheet

Feuille de compétition

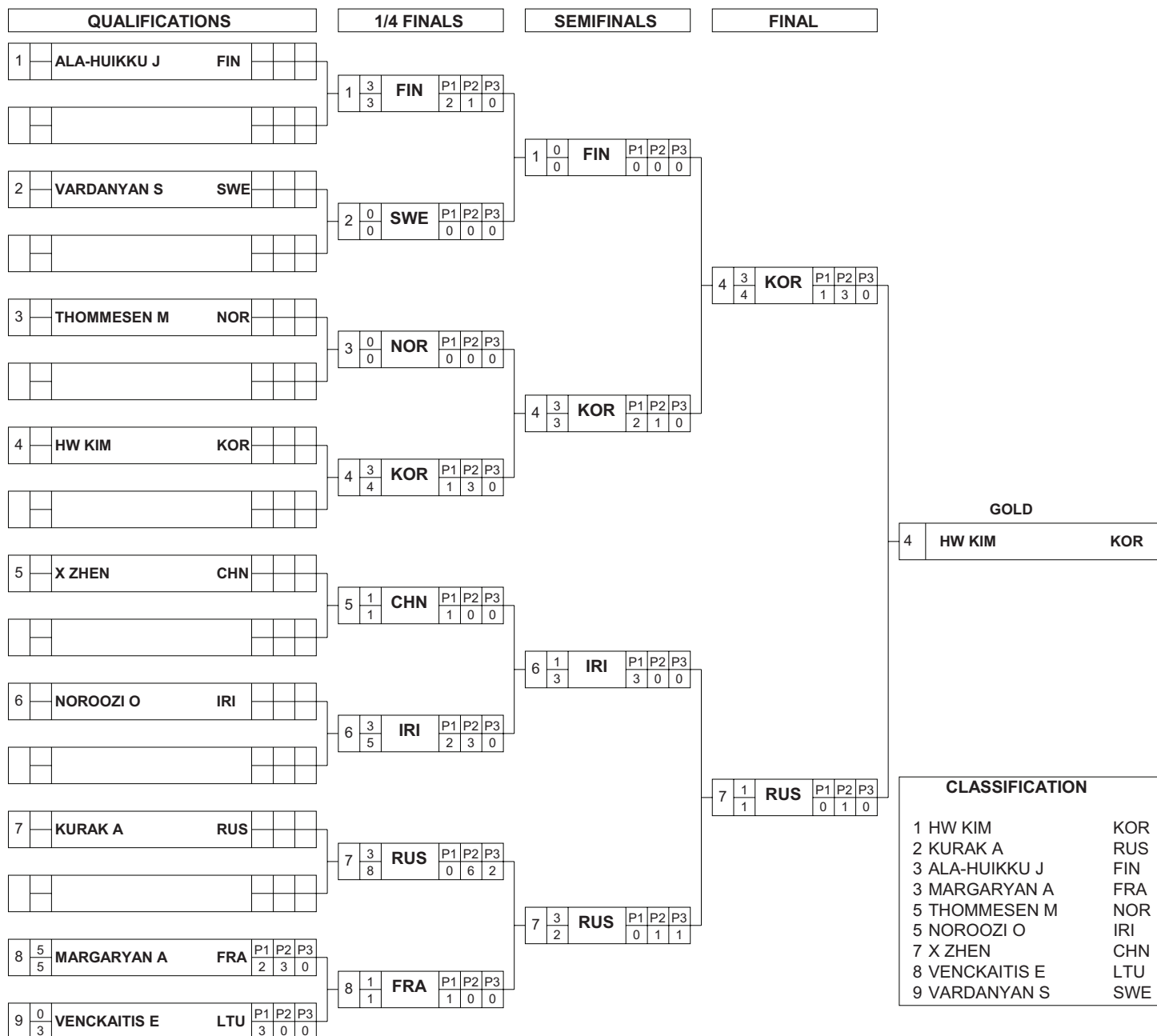

Competition Sheet

Feuille de compétition

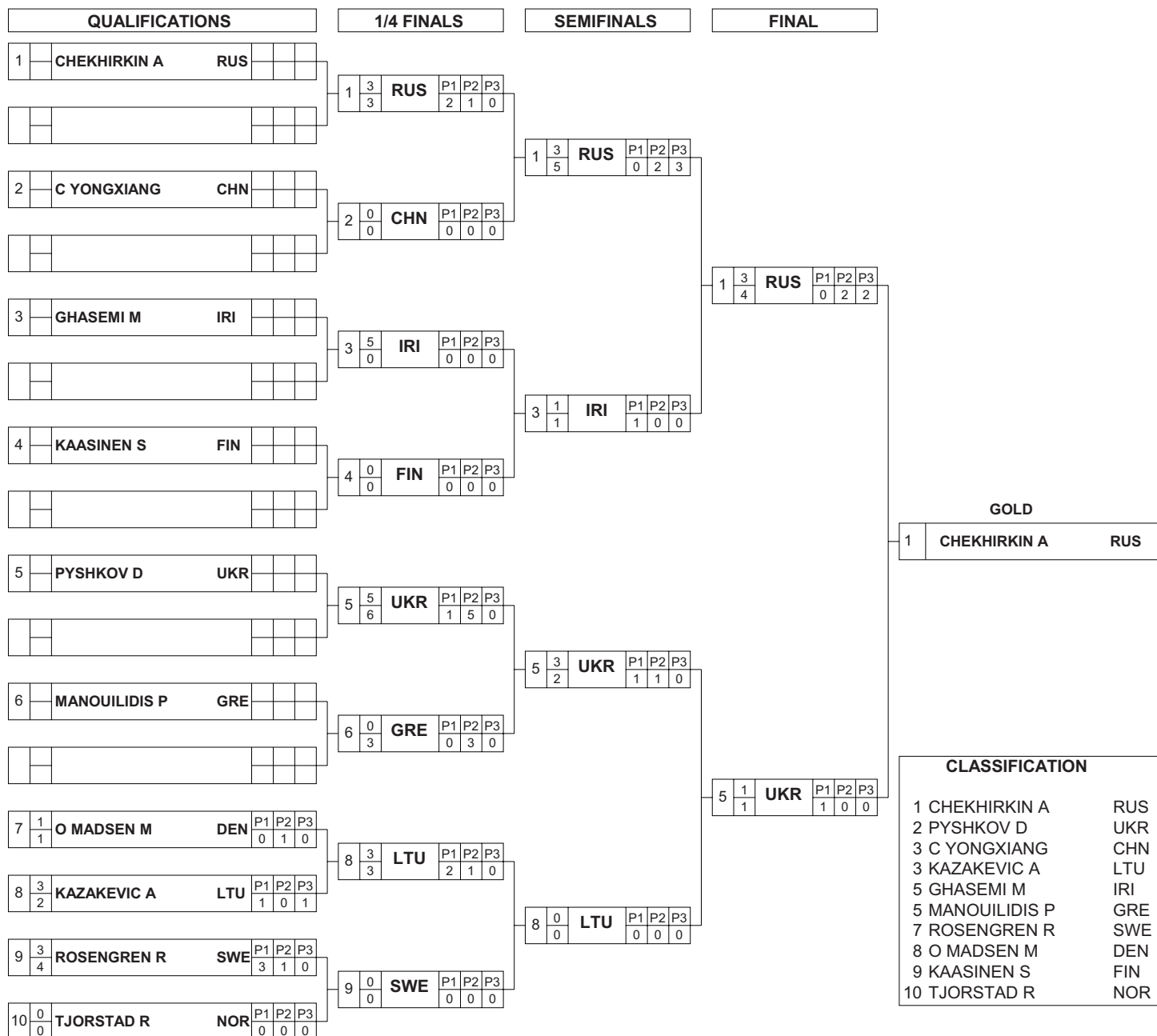

REPECHAGE

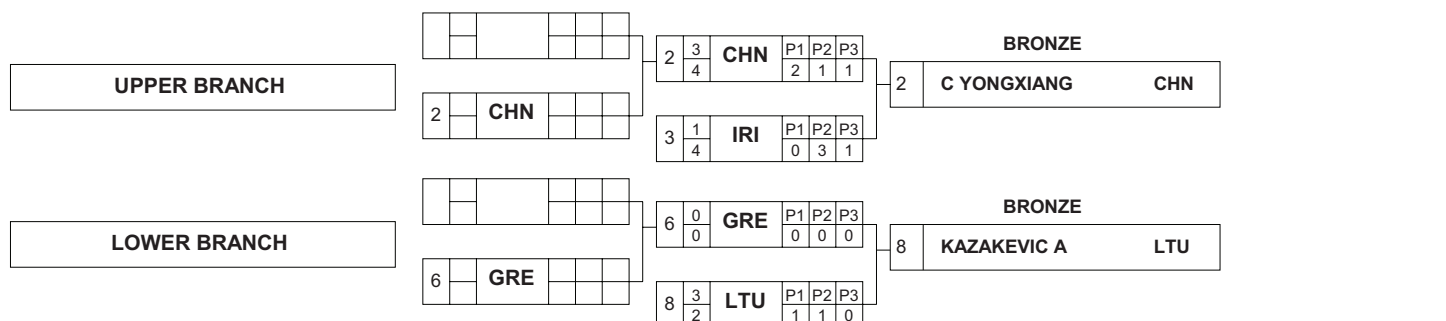

Competition Sheet

Feuille de compétition

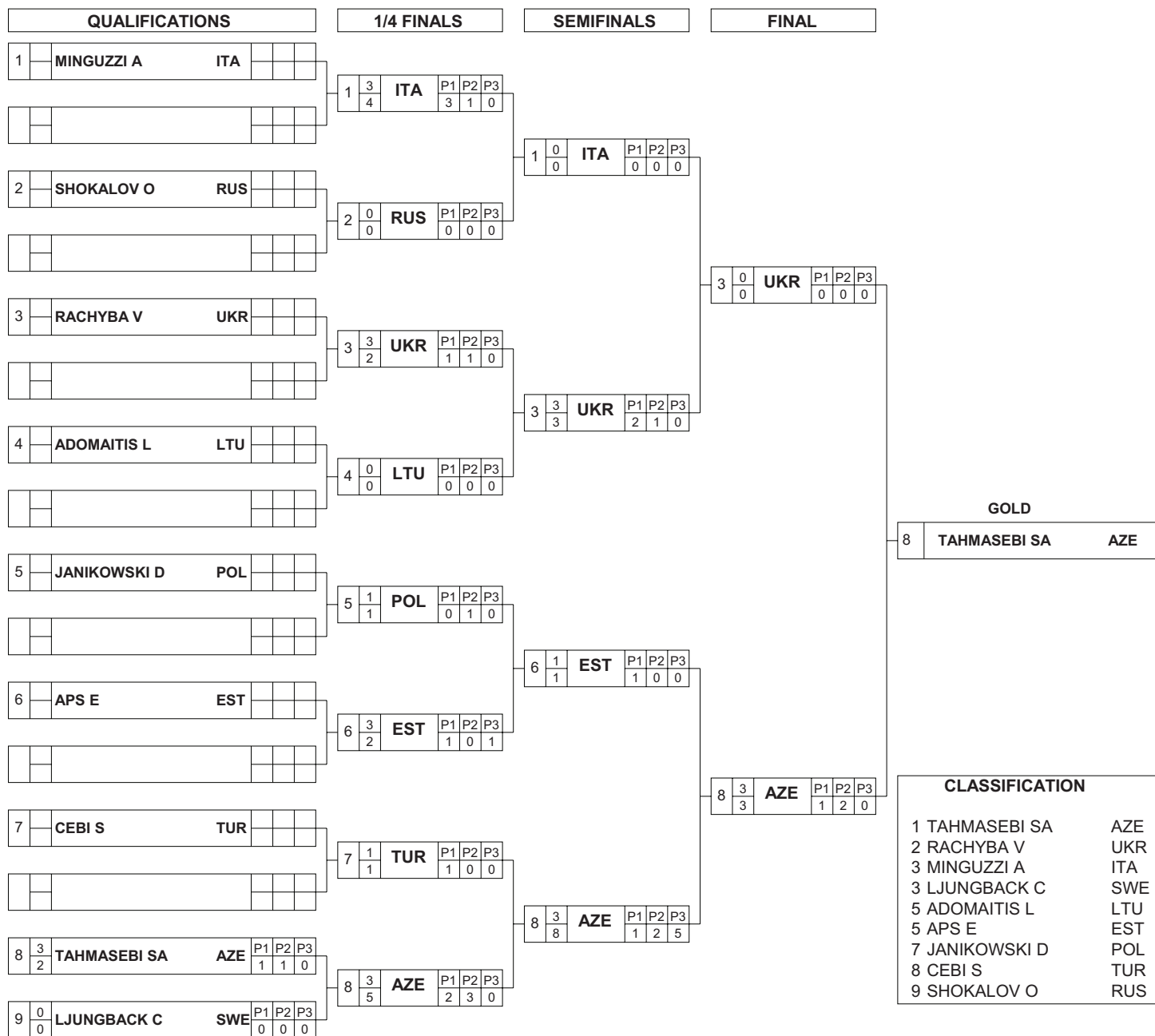

REPECHAGE

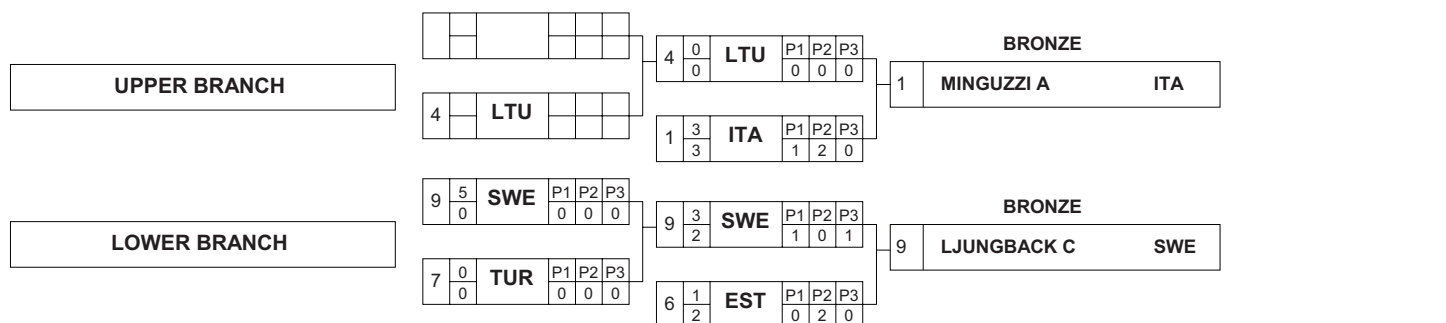

Competition Sheet
Feuille de compétition

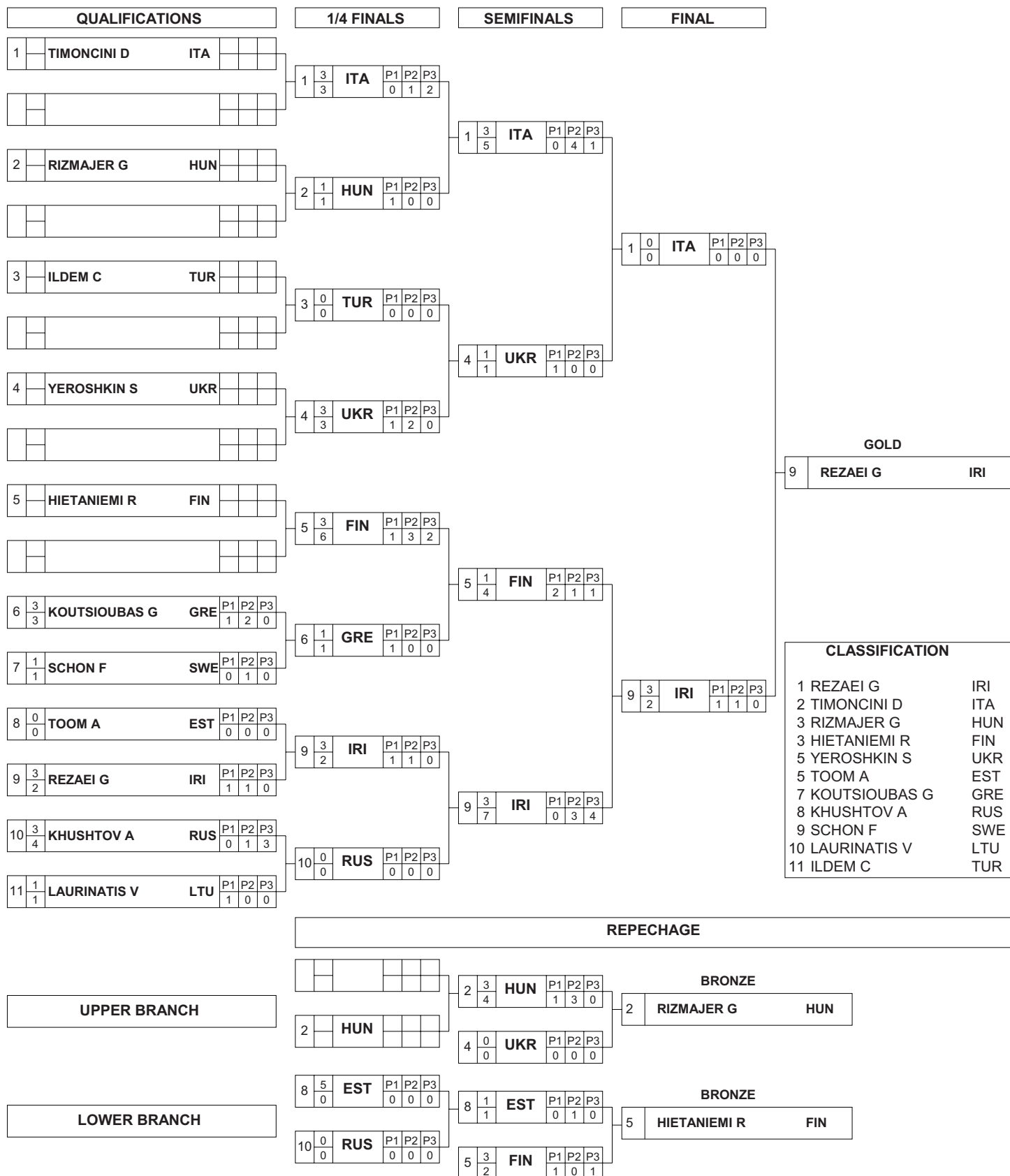

Competition Sheet

Feuille de compétition

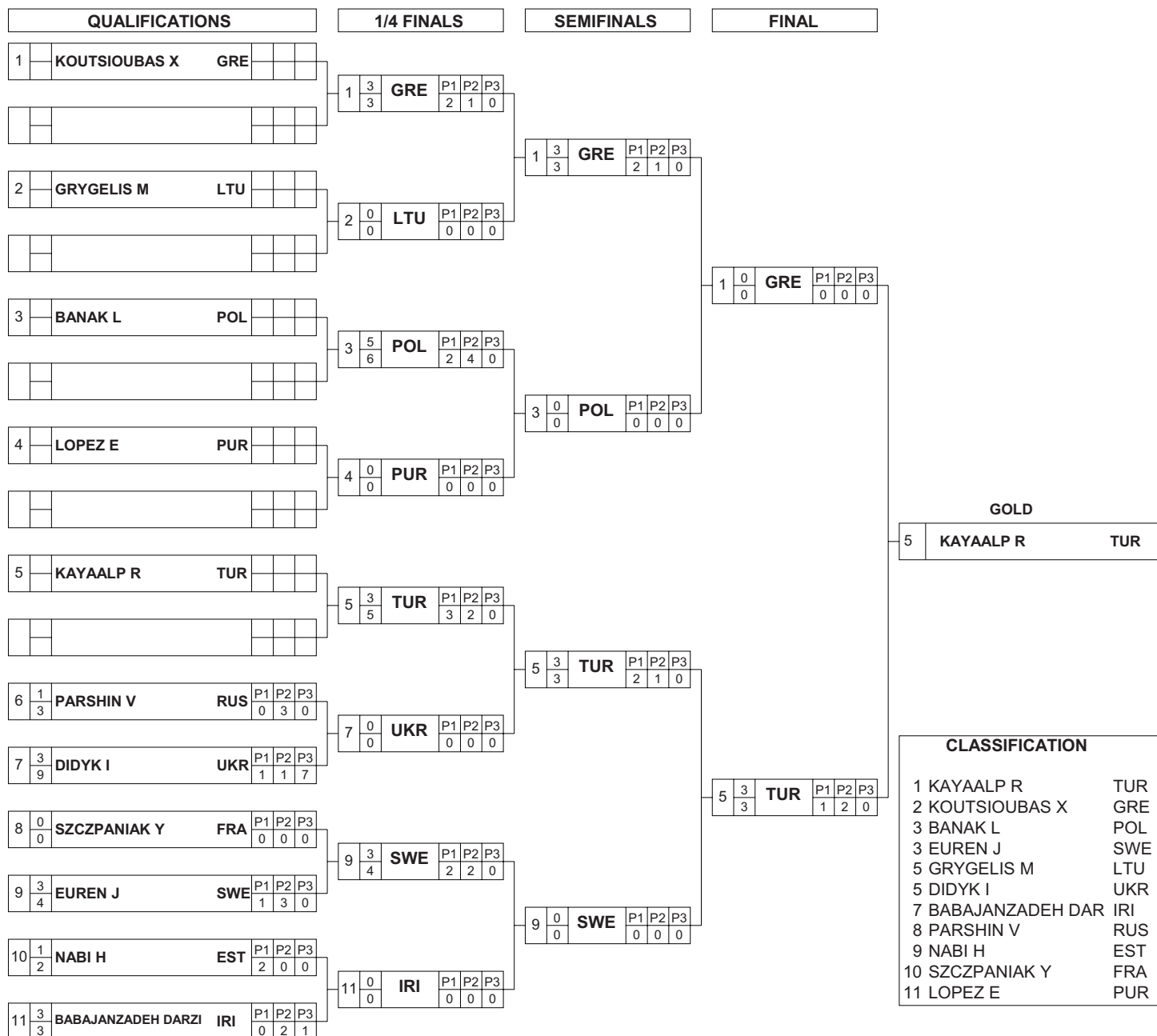

REPECHAGE

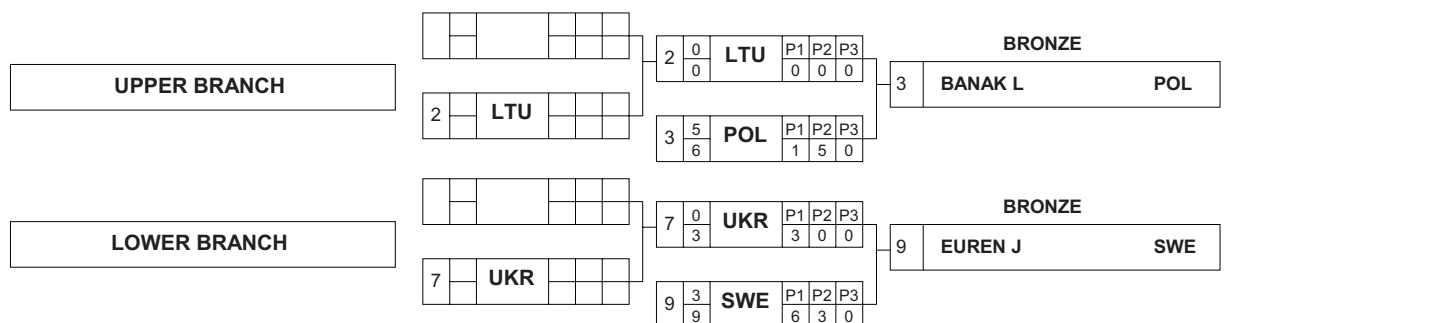

Competition Sheet

Feuille de compétition

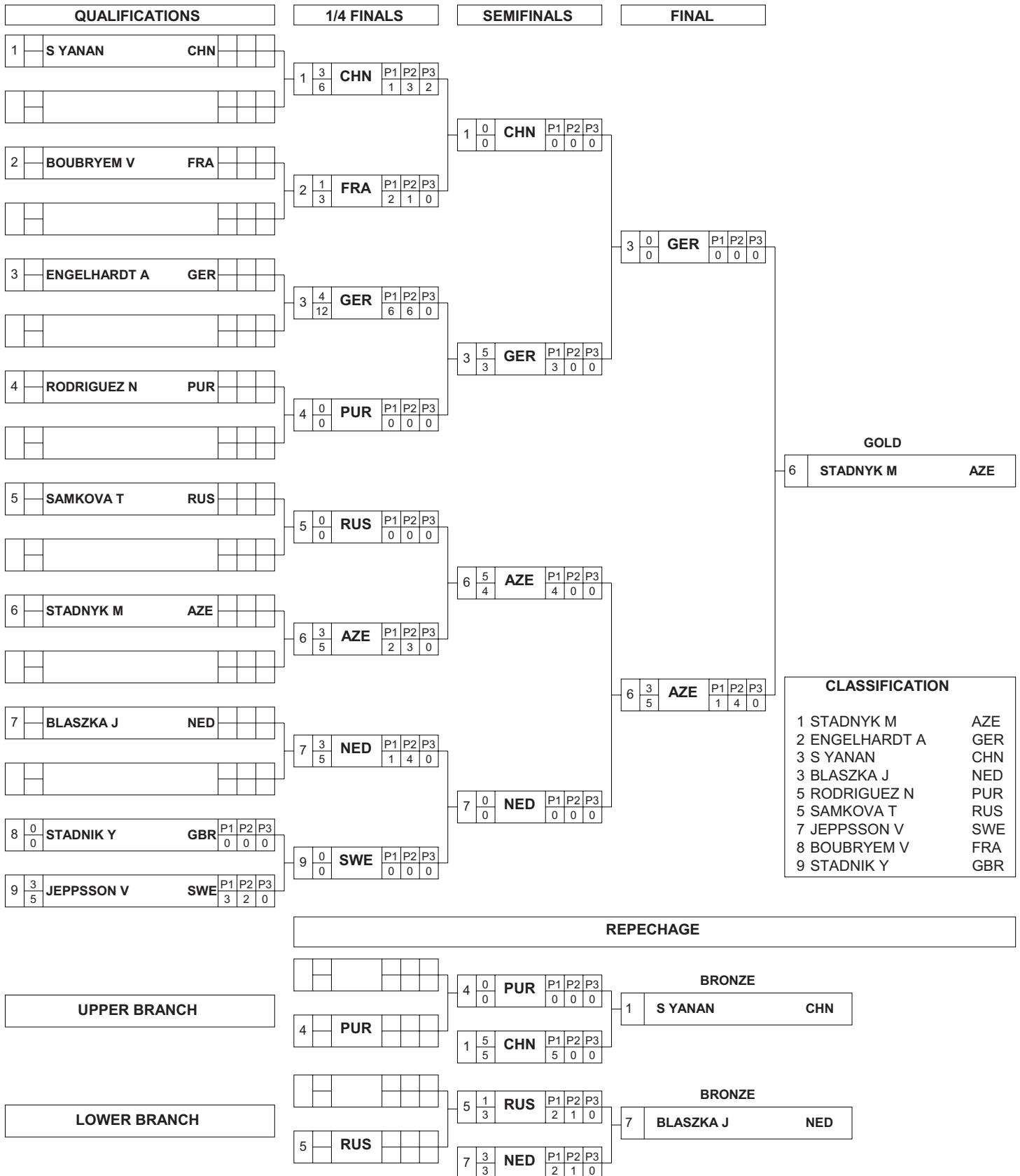

Competition Sheet

Feuille de compétition

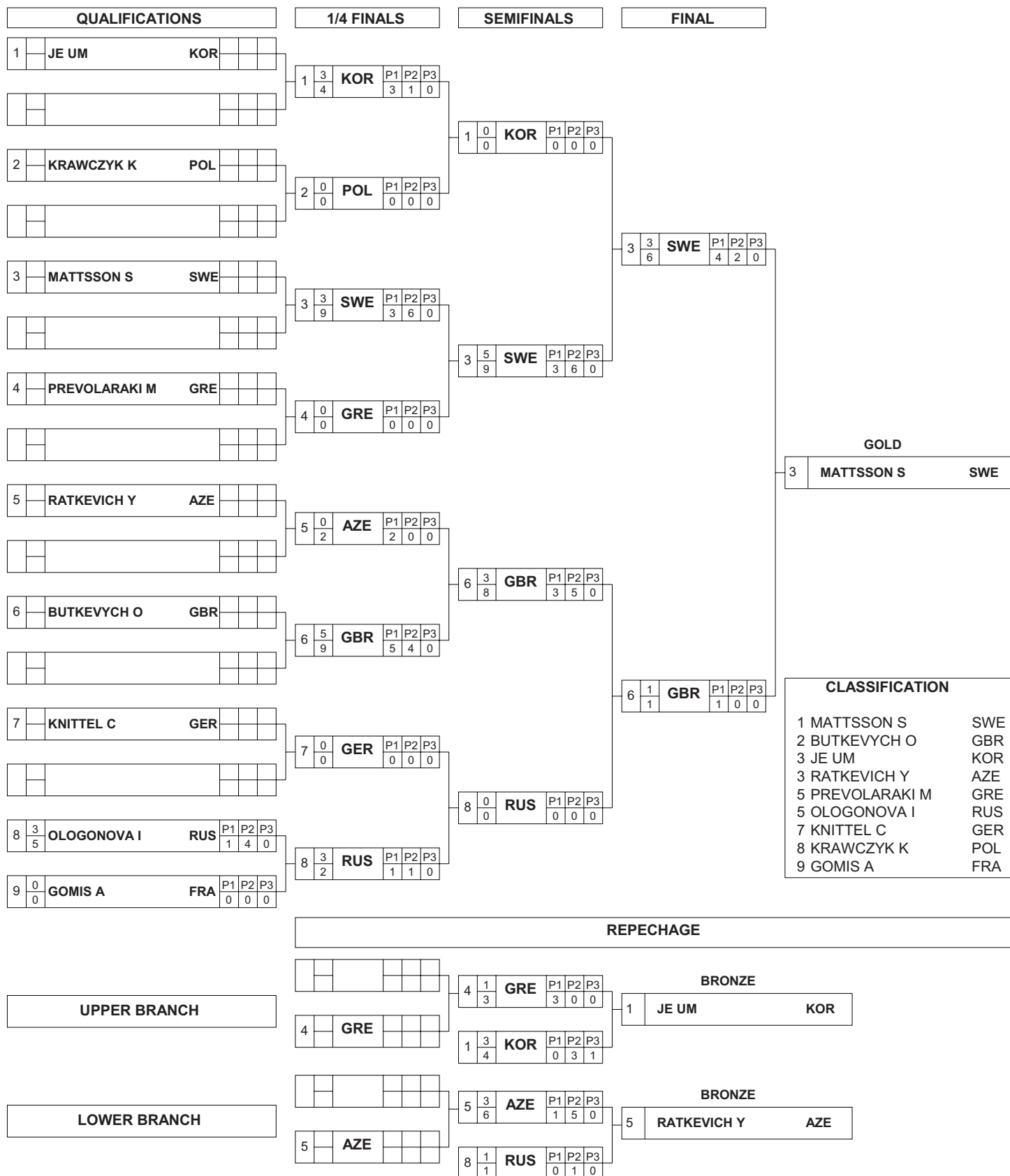

Competition Sheet
Feuille de compétition

QUALIFICATIONS		1/4 FINALS		SEMIFINALS		FINAL	
1	MICHALIK M POL	1	3/6 POL P1 P2 P3 1 5 0	1	0/0 POL P1 P2 P3 0 0 0		
2	DUNN M GUM	2	0/0 GUM P1 P2 P3 0 0 0				
3	TRAZHUKOVA I RUS	3	0/0 RUS P1 P2 P3 0 0 0	4	3/2 CHN P1 P2 P3 1 1 0		
4	XILUOZHUOMA CHN	4	3/2 CHN P1 P2 P3 1 1 0	4	1/1 CHN P1 P2 P3 1 0 0		
5	MATTSSON J SWE	5	3/5 SWE P1 P2 P3 4 1 0	5	3/2 SWE P1 P2 P3 1 1 0		
6	FOCTEN A GER	6	0/0 GER P1 P2 P3 0 0 0	5	3/4 SWE P1 P2 P3 0 3 1		
7	SKUJINA L LAT	7	5/3 LAT P1 P2 P3 3 0 0	7	0/0 LAT P1 P2 P3 0 0 0		
8	CONNOLLY S GBR	9	0/0 KOR P1 P2 P3 0 0 0				
9	JS CHOE KOR						

GOLD	
5	MATTSSON J SWE

CLASSIFICATION	
1	MATTSSON J SWE
2	XILUOZHUOMA CHN
3	MICHALIK M POL
3	FOCTEN A GER
5	TRAZHUKOVA I RUS
5	SKUJINA L LAT
7	JS CHOE KOR
8	CONNOLLY S GBR
9	DUNN M GUM

REPECHAGE	
UPPER BRANCH	
3	RUS
1	3/2 POL P1 P2 P3 1 1 0
LOWER BRANCH	
6	3/2 GER P1 P2 P3 0 1 1
7	1/1 LAT P1 P2 P3 1 0 0
BRONZE	
1	MICHALIK M POL
BRONZE	
6	FOCTEN A GER

Competition Sheet
Feuille de compétition

QUALIFICATIONS		1/4 FINALS		SEMIFINALS		FINAL	
1	SELMAIER M GER	1	1 GER 1 1	2	0 CMR 0 0	4	1 BUL 2 1
2	ALI AL CMR	2	3 CMR 9 1	4	3 BUL 2 1	8	BUKINA E RUS
3	MAE E EST	3	0 EST 0 0	5	1 SWE 1 0		
4	STANKA Z BUL	4	3 BUL 4 1	6	1 CHN 4 0		
5	FRANSSON J SWE	5	3 SWE 5 1	7	0 GBR 0 0		
6	X QING CHN	6	1 CHN 4 0	8	3 RUS 3 1		
7	SPITERI C GBR	7	0 GBR 0 0	8	5 RUS 12 6		
8	BUKINA E RUS	8	3 BUKINA E 8 2				
9	ERLANDSEN M NOR	9	1 ERLANDSEN M 1 0				

CLASSIFICATION

1	BUKINA E	RUS
2	STANKA Z	BUL
3	ALI AL	CMR
3	FRANSSON J	SWE
5	MAE E	EST
5	ERLANDSEN M	NOR
7	X QING	CHN
8	SELMAIER M	GER
9	SPITERI C	GBR

REPECHAGE

UPPER BRANCH		LOWER BRANCH	
3	EST	9	5 NOR 12 8
2	3 CMR 10 3	7	0 GBR 0 0
3	1 EST 4 0	5	3 SWE 5 2
2	ALI AL CMR	9	1 NOR 1 0
5	FRANSSON J SWE		

Competition Sheet

Feuille de compétition

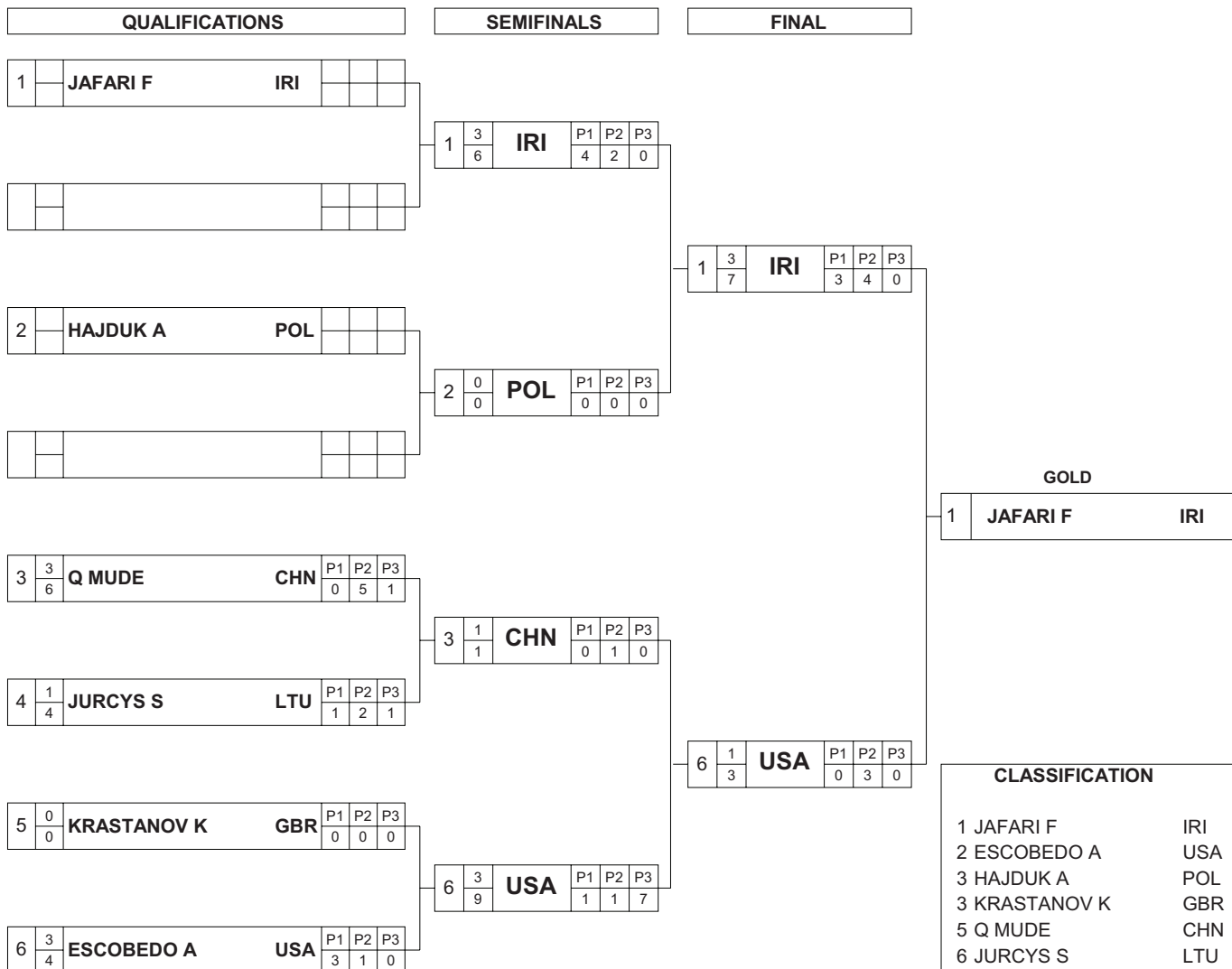

Competition Sheet

Feuille de compétition

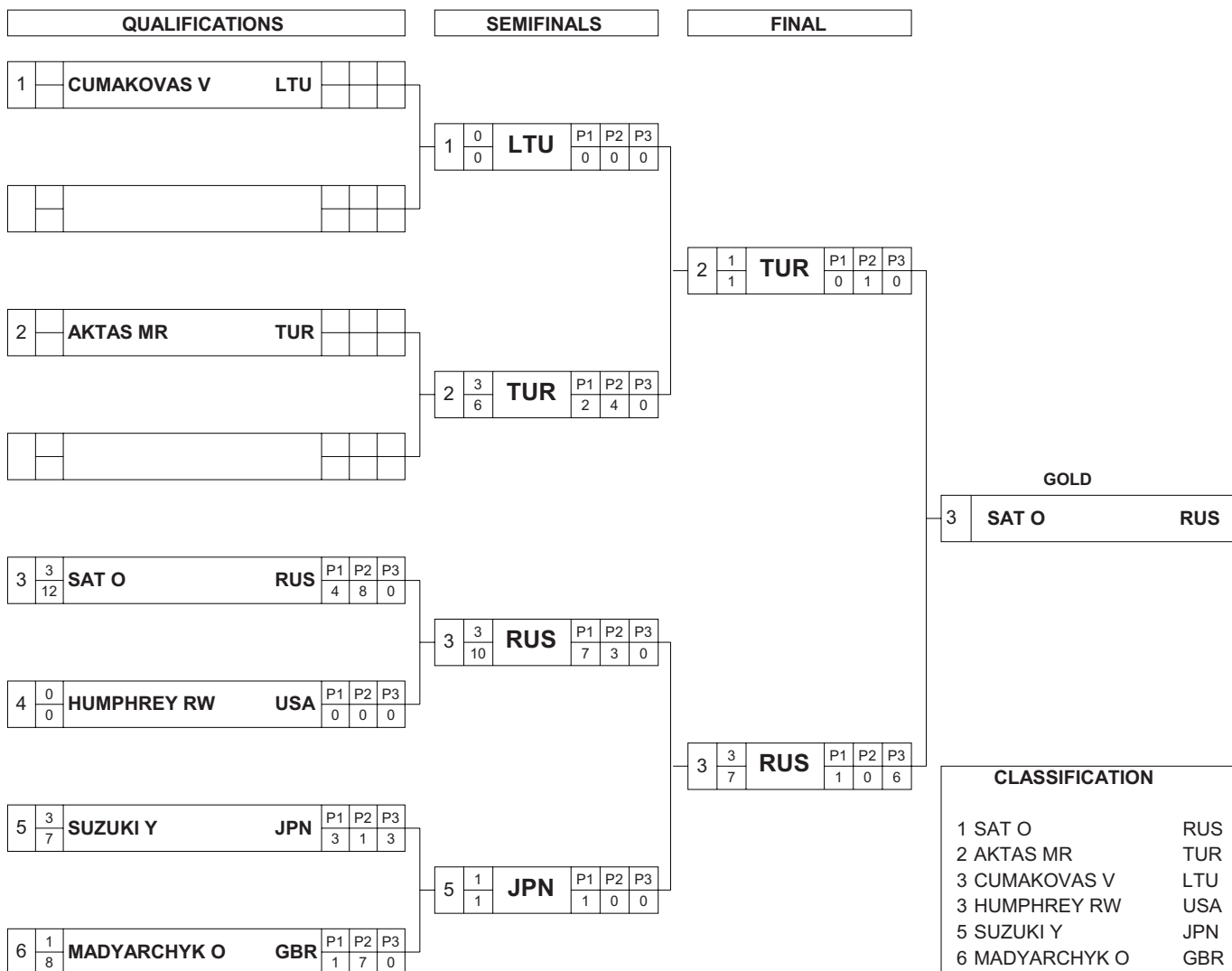

Competition Sheet

Feuille de compétition

1/4 FINALS				SEMIFINALS				FINAL																										
1	5/0	ALDAMOV B	GBR	P1 0	P2 0	P3 0	1	1/2	GBR	P1 0	P2 2	P3 0	7	METCALF B	USA																			
2	0/0	LEBEDEV V	RUS	P1 0	P2 0	P3 0																												
3	1/1	TSERENDALAI B	MGL	P1 1	P2 0	P3 0	4	3/6	JPN	P1 1	P2 5	P3 0																						
4	3/10	TANAKA K	JPN	P1 3	P2 7	P3 0																												
5	0/0	HOSSEINKHANI M	IRI	P1 0	P2 0	P3 0	6	1/1	AZE	P1 0	P2 1	P3 0																						
6	3/3	HASANOV J	AZE	P1 1	P2 2	P3 0																												
7	3/8	METCALF B	USA	P1 0	P2 5	P3 3	7	3/7	USA	P1 3	P2 0	P3 4																						
8	1/1	WOLLER G	HUN	P1 1	P2 0	P3 0																												
								4				0/0				JPN				P1 0				P2 0				P3 0						
GOLD																																		
CLASSIFICATION																																		
1 METCALF B USA																																		
2 TANAKA K JPN																																		
3 ALDAMOV B GBR																																		
3 HASANOV J AZE																																		
5 TSERENDALAI B MGL																																		
5 WOLLER G HUN																																		
7 LEBEDEV V RUS																																		
8 HOSSEINKHANI M IRI																																		

REPECHAGE																											
UPPER BRANCH				3				0/0				MGL				P1 0				P2 0				P3 0			
LOWER BRANCH				1				3/8				GBR				P1 3				P2 5				P3 0			
BRONZE																											
1 ALDAMOV B GBR																											
BRONZE																											
6 HASANOV J AZE																											
				8				1/1				HUN				P1 0				P2 1				P3 0			
				6				3/4				AZE				P1 2				P2 2				P3 0			

Competition Sheet

Feuille de compétition

1/4 FINALS				SEMIFINALS				FINAL										
1	3/6	GEDUEV A	RUS	P1 3	P2 0	P3 3	1	3/4	RUS	P1 1	P2 3	P3 0	1	3/9	RUS	P1 6	P2 3	P3 0
2	1/1	ALIYEV A	AZE	P1 0	P2 1	P3 0		4	0/0	POL	P1 0	P2 0		P3 0	6	0/0	USA	P1 0
3	1/4	MOTSALIN O	GRE	P1 0	P2 4	P3 0	4	0/0	POL	P1 0	P2 0	P3 0	6	3/3	USA	P1 0	P2 2	P3 1
4	3/2	SOBIERAJ A	POL	P1 1	P2 0	P3 1		7	1/1	FRA	P1 1	P2 0		P3 0	7	1/1	FRA	P1 1
5	1/1	Z CHONGYAO	CHN	P1 1	P2 0	P3 0	6	3/3	USA	P1 0	P2 2	P3 1	6	0/0	USA	P1 0	P2 0	P3 0
6	3/7	HOWE A	USA	P1 1	P2 6	P3 0		7	1/1	FRA	P1 1	P2 0		P3 0	7	1/1	FRA	P1 1
7	3/7	LAMPIS L	FRA	P1 1	P2 6	P3 0	7	1/1	FRA	P1 1	P2 0	P3 0	7	1/1	FRA	P1 1	P2 0	P3 0
8	0/0	ROBERTS P	GBR	P1 0	P2 0	P3 0		8	0/0	ROBERTS P	P1 0	P2 0		P3 0	8	0/0	ROBERTS P	P1 0

GOLD

1	GEDUEV A	RUS
---	----------	-----

CLASSIFICATION

1	GEDUEV A	RUS
2	HOWE A	USA
3	ALIYEV A	AZE
3	Z CHONGYAO	CHN
5	SOBIERAJ A	POL
5	LAMPIS L	FRA
7	MOTSALIN O	GRE
8	ROBERTS P	GBR

REPECHAGE

UPPER BRANCH				LOWER BRANCH						
2	3/7	ALIYEV A	AZE	P1 4	P2 3	P3 0	2	1/2	ALIYEV A	AZE
4	1/2	POL	POL	P1 1	P2 1	P3 0		5	3/7	Z CHONGYAO
5	3/7	Z CHONGYAO	CHN	P1 1	P2 6	P3 0	5	0/0	Z CHONGYAO	CHN
7	0/0	FRA	FRA	P1 0	P2 0	P3 0		7	0/0	FRA

BRONZE

BRONZE

Competition Sheet

Feuille de compétition

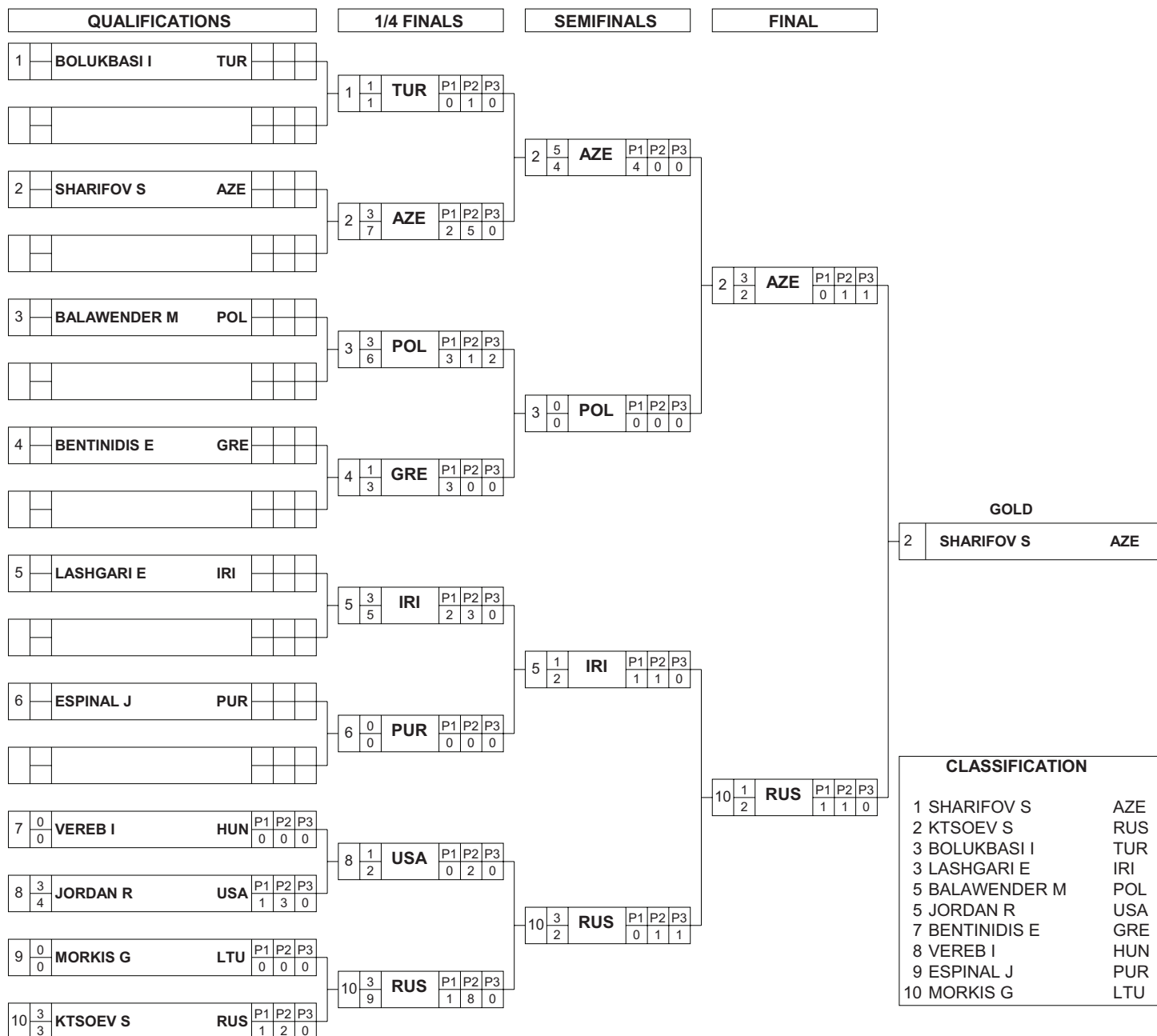

REPECHAGE

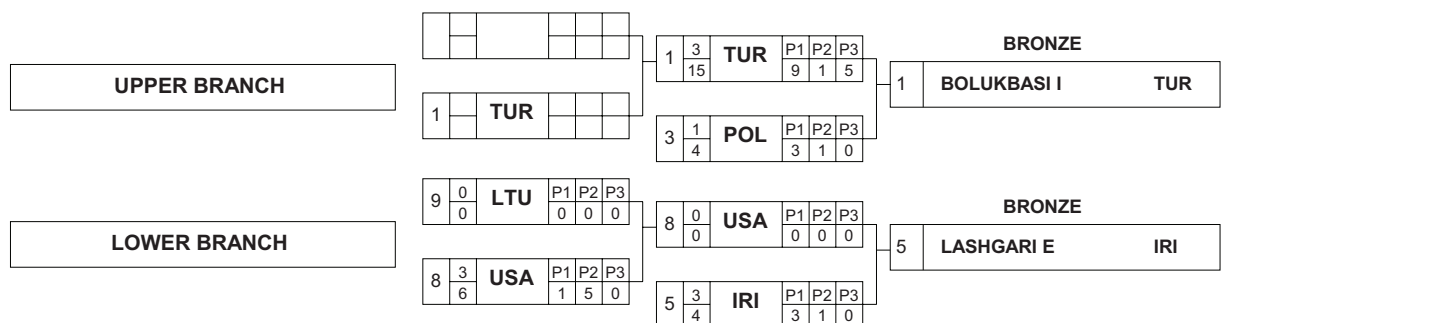

Competition Sheet
Feuille de compétition

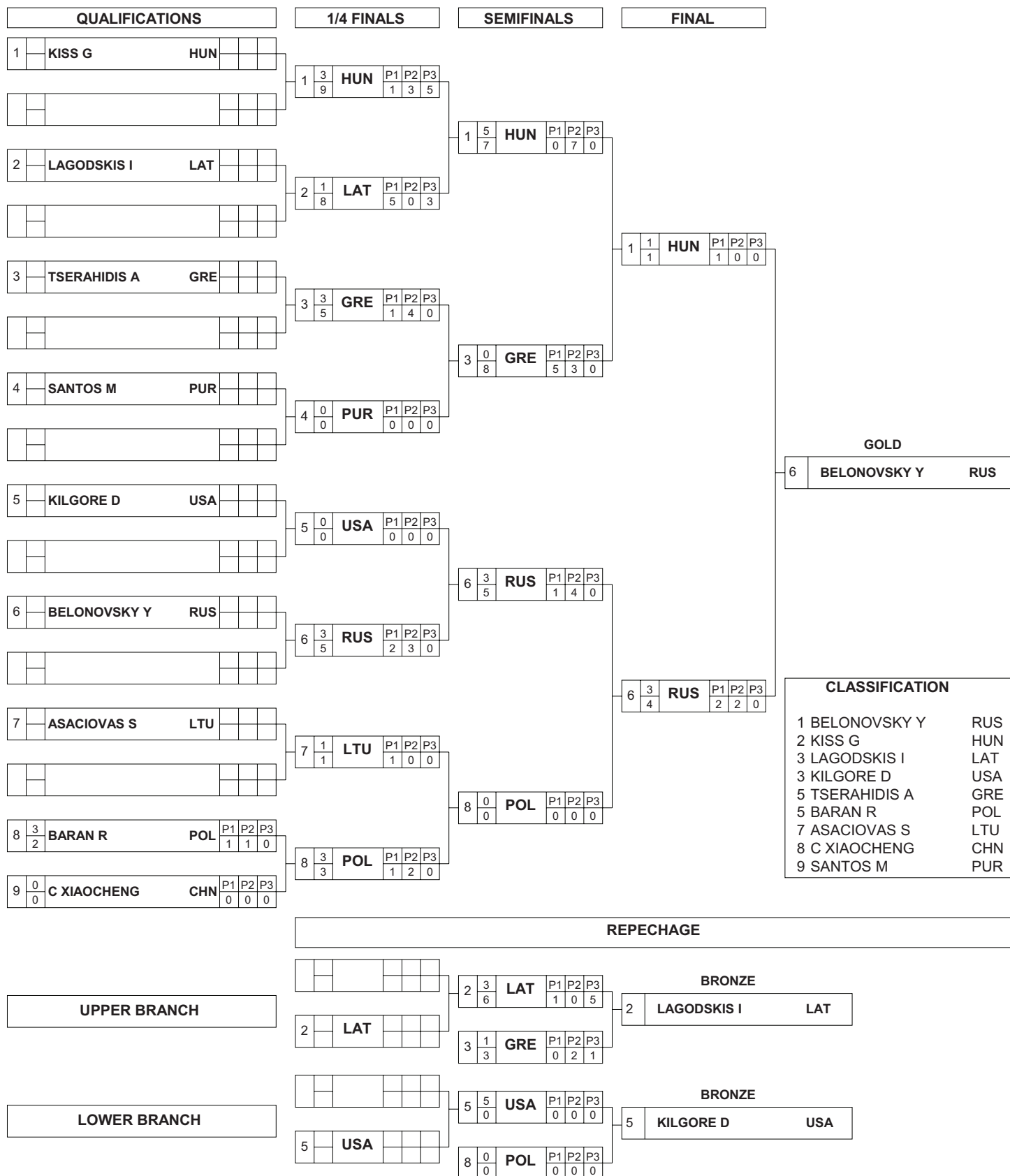

Competition Sheet

Feuille de compétition

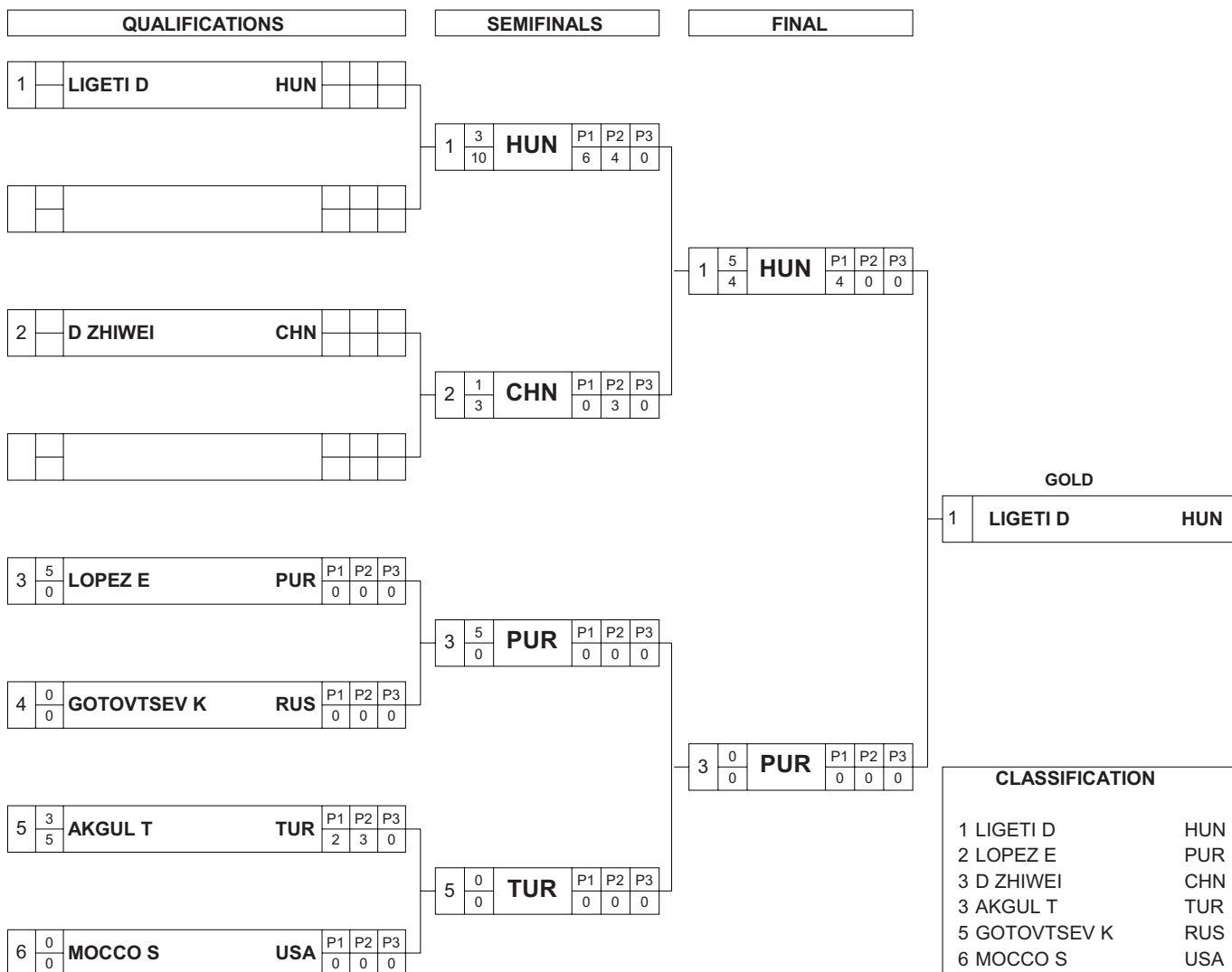

CLASSIFICATION	
1	LIGETI D HUN
2	LOPEZ E PUR
3	D ZHIWEI CHN
3	AKGUL T TUR
5	GOTOVTSEV K RUS
6	MOCCO S USA

REPECHAGE

