

SENIOR WORLD CHAMPIONSHIPS



MOSCOW (RUS)

2010-09-06 - 2010-09-12 2010

Résultats - Results

Lutte Libre - Free-Style



**Liste des arbitres / Referee list****Senior World Championships**WORLD WRESTLING
CHAMPIONSHIP

| N° | Licence | Pays Country | Nom - Last Name | Prénom - First Name |
|----|---------|-----------------|-----------------|---------------------|
| | 3106 | BUL | KOSTADINOV | Iantcho |
| | 1079 | CUB | MOLINA GONZALEZ | Guillermo Orestes |
| | 2083 | FIN | TOIVOLA | Karri |
| | 3077 | POL | BRUDZINSKI | Grzegorz |
| | 1734 | RUS | TULUPOV | Vitaly |
| | 2551 | SUI | NOBS | Marianne |
| | 2525 | TUN | BOUAZIZ | Kamel |
| | 770 | USA | TUCCI | Rick |
| | 3129 | UZB | MIHAYILOV | Konstantin |
| 1 | 1598 | CAN | MACKAY | Lee Ronald |
| 2 | 3456 | HUN | PÉTERI | László |
| 3 | 3187 | IRI | TALEBI | Bahman |
| 4 | 3520 | TUR | CICIOGLU | Ibrahim |
| 5 | 3364 | CRO | PETANJEK | Davor |
| 6 | 2224 | GRE | PAGONIS | Vassilios |
| 7 | 2424 | SUI | MEIER | Viktor |
| 8 | 3218 | JPN | ASHIDA | Takaharu |
| 9 | 3267 | RUS | NOVAKOVSKIY | Sergey |
| 10 | 3175 | FIN | TALVITIE | Jaakko |
| 11 | 3213 | JPN | SAITO | Osamu |
| 12 | 4356 | ITA | DÓZSA | Edit |
| 13 | 3826 | SUI | PUTALLAZ | Claude-Alain |
| 14 | 3924 | USA | ERRETT | Zach |
| 15 | 3334 | UKR | KOLENKOV | Olexandr |
| 16 | 3349 | KGZ | KULMATOV | Kochkor |
| 17 | 2559 | GRE | HAMAKOS | Georgios |
| 18 | 2250 | FRA | AIT BRAHAM | Robert |
| 19 | 3231 | TPE | JANG | Tsong-Rong |
| 20 | 3524 | EST | AROLD | Peep |
| 21 | 1351 | MGL | BASKHUU | Aduuch |
| 22 | 3291 | CHN | ZHANG | Xia |
| 24 | 2212 | BUL | ANTOV | Petar |
| 25 | 2541 | ROU | LAZAR | Ovidiu |
| 26 | 3417 | TUR | CEKER | Bekir |
| 27 | 3749 | RUS | KRIKOV | Andrei |
| 28 | 2730 | ITA | NULLI GABBIANI | Giampiero |
| 29 | 3994 | KOR | CHIN | Hyung-Kyun |
| 30 | 3052 | IRI | TAHMASABI | Ali Akbar |
| 31 | 2231 | COL | VELEZ | Gustavo de Jesus |

**Liste des arbitres / Referee list****Senior World Championships**

| N° | Licence | Pays Country | Nom - Last Name | Prénom - First Name |
|-----------|----------------|-------------------------|------------------------|----------------------------|
| 32 | 3788 | GRE | MIGIPI | Anastasia |
| 33 | 4357 | HUN | BACSA | Péter |
| 34 | 2546 | FRA | LE GLEUT | Régine |
| 35 | 3076 | POL | GLAZ | Andrzej |
| 36 | 2686 | USA | CLARK | Tom |
| 37 | 2513 | GEO | MACHAIDZE | Edisher |
| 38 | 2385 | MAR | MOCHAFFAA | Noredine |
| 39 | 2346 | GER | PROBST | Eberhard |
| 40 | 3284 | UZB | GULAMOV | Tokhir |
| 41 | 2818 | CYP | LOUKA | Loukas |
| 42 | 3286 | CHN | PAN | Hongjun |
| 43 | 3709 | CAN | FRENCH | David |

Nombre d'arbitres - Number of Referee

51



Liste des nations / Countries List

















































Senior World Championships

STYLE FS



WORLD WRESTLING
FEBRUARY 16-21, 2014
CHAMPIONSHIP

Pays - Country

| | | |
|---|-----------------------|-----|
|  | AFRIQUE DU SUD | RSA |
|  | ALBANIE | ALB |
|  | ALLEMAGNE | GER |
|  | ARGENTINE | ARG |
|  | ARMENIE | ARM |
|  | AUSTRALIE | AUS |
|  | AUTRICHE | AUT |
|  | AZERBAIDJAN | AZE |
|  | BELARUS | BLR |
|  | BRESIL | BRA |
|  | BULGARIE | BUL |
|  | CAMEROUN | CMR |
|  | CANADA | CAN |
|  | CHINE | CHN |
|  | CHYPRE | CYP |
|  | COREE | KOR |
|  | CUBA | CUB |
|  | DOMINICAINE REP. | DOM |
|  | EGYPTE | EGY |
|  | EQUATEUR | ECU |
|  | ESPAGNE | ESP |
|  | ESTONIE | EST |
|  | ETATS-UNIS | USA |
|  | FINLANDE | FIN |
|  | FRANCE | FRA |
|  | GEORGIE | GEO |
|  | GRANDE BRETAGNE | GBR |
|  | GRECE | GRE |
|  | GUAM | GUM |
|  | GUINEE-BISSAU | GBS |
|  | HONGRIE | HUN |
|  | ILES SALOMON | SOL |
|  | INDE | IND |
|  | IRAN R.I. | IRI |
|  | ISRAEL | ISR |
|  | ITALIE | ITA |
|  | JAPON | JPN |
|  | KAZAKHSTAN | KAZ |
|  | KIRGIZSTAN | KGZ |
|  | LETTONIE | LAT |
|  | LITUANIE | LTU |
|  | MACEDOINE ANC. R. YUG | MKD |
|  | MADAGASCAR | MAD |
|  | MALTE | MLT |
|  | MOLDAVIE | MDA |
|  | MONACO | MON |
|  | MONGOLIE | MGL |
|  | NIGERIA | NGR |



Liste des nations / Countries List

Senior World Championships

STYLE FS



| | | |
|---|------------------|-----|
|  | NOUVELLE-ZELANDE | NZL |
|  | OUZBEKISTAN | UZB |
|  | POLOGNE | POL |
|  | PORTO RICO | PUR |
|  | ROUMANIE | ROU |
|  | RUSSIE | RUS |
|  | SENEGAL | SEN |
|  | SLOVAQUIE | SVK |
|  | SUISSE | SUI |
|  | TADJIKISTAN | TJK |
|  | TCHAD | CHA |
|  | TURKMENISTAN | TKM |
|  | TURQUIE | TUR |
|  | UKRAINE | UKR |
|  | URUGUAY | URU |
|  | VENEZUELA | VEN |

Nombre de nations - Number of Countries 64

**Nombre d'engagés par nation / Number of Entries By Country****Senior World Championships**

STYLE FS

WORLD WRESTLING
FEDERATION SENIOR WORLD
CHAMPIONSHIP

| <i>Pays - Country</i> | <i>55 KG</i> | <i>60 KG</i> | <i>66 KG</i> | <i>74 KG</i> | <i>84 KG</i> | <i>96 KG</i> | <i>120 KG</i> | <i>TOTAL</i> |
|-----------------------|--------------|--------------|--------------|--------------|--------------|--------------|---------------|--------------|
| ALB | | 1 | | | | | | 1 |
| ARG | | | | | 1 | | | 1 |
| ARM | 1 | 1 | 1 | 1 | 1 | 1 | 1 | 7 |
| AUS | | | | 1 | | | | 1 |
| AUT | | | | 1 | | | | 1 |
| AZE | 1 | 1 | 1 | 1 | 1 | 1 | 1 | 7 |
| BLR | 1 | 1 | 1 | 1 | 1 | 1 | 1 | 7 |
| BRA | | | | | | | 1 | 1 |
| BUL | 1 | 1 | 1 | 1 | 1 | 1 | 1 | 7 |
| CAN | 1 | 1 | 1 | 1 | 1 | 1 | 1 | 7 |
| CHA | | | | | | 1 | | 1 |
| CHN | 1 | 1 | 1 | 1 | | 1 | 1 | 6 |
| CMR | 1 | | | | | | 1 | 2 |
| CUB | 1 | 1 | 1 | 1 | 1 | 1 | | 6 |
| CYP | | | | | | 1 | 1 | 2 |
| DOM | | 1 | | | | | | 1 |
| ECU | | | 1 | | | | | 1 |
| EGY | 1 | 1 | 1 | | | | | 3 |
| ESP | 1 | 1 | | | 1 | | 1 | 4 |
| EST | | | 1 | | | | | 1 |
| FIN | | 1 | | | | | | 1 |
| FRA | 1 | 1 | | 1 | | | | 3 |
| GBR | 1 | | | | | 1 | | 2 |
| GBS | | | | 1 | | | | 1 |
| GEO | 1 | 1 | 1 | 1 | 1 | 1 | 1 | 7 |
| GER | 1 | 1 | 1 | 1 | 1 | 1 | | 6 |
| GRE | | | 1 | 1 | 1 | 1 | 1 | 5 |
| GUM | | | 1 | | | | | 1 |
| HUN | | | | 1 | 1 | | 1 | 3 |
| IND | | 1 | 1 | 1 | | | | 3 |
| IRI | 1 | 1 | 1 | 1 | 1 | 1 | 1 | 7 |
| ISR | | | 1 | | | | | 1 |
| ITA | | | 1 | | 1 | | | 2 |



Nombre d'engagés par nation / Number of Entries By Country

Senior World Championships

STYLE FS



| <i>Pays - Country</i> | <i>55 KG</i> | <i>60 KG</i> | <i>66 KG</i> | <i>74 KG</i> | <i>84 KG</i> | <i>96 KG</i> | <i>120 KG</i> | <i>TOTAL</i> |
|-----------------------|--------------|--------------|--------------|--------------|--------------|--------------|---------------|--------------|
| JPN | 1 | 1 | 1 | 1 | 1 | 1 | 1 | 7 |
| KAZ | 1 | 1 | 1 | 1 | 1 | 1 | 1 | 7 |
| KGZ | 1 | 1 | | | | 1 | 1 | 4 |
| KOR | 1 | 1 | 1 | 1 | 1 | 1 | | 6 |
| LAT | | 1 | | | 1 | 1 | 1 | 4 |
| LTU | 1 | | | | | | | 1 |
| MAD | 1 | | | | | | | 1 |
| MDA | 1 | 1 | 1 | 1 | 1 | 1 | 1 | 7 |
| MGL | 1 | 1 | 1 | 1 | 1 | 1 | 1 | 7 |
| MKD | | | 1 | | 1 | 1 | | 3 |
| MLT | | | | | 1 | | | 1 |
| MON | 1 | | | | | | | 1 |
| NGR | | 1 | | | | 1 | | 2 |
| NZL | | | 1 | | 1 | | 1 | 3 |
| POL | 1 | | | 1 | 1 | 1 | 1 | 5 |
| PUR | | 1 | | | 1 | | | 2 |
| ROU | 1 | 1 | 1 | 1 | 1 | | | 5 |
| RSA | | | 1 | 1 | 1 | 1 | | 4 |
| RUS | 1 | 1 | 1 | 1 | 1 | 1 | 1 | 7 |
| SEN | | | | | | 1 | | 1 |
| SOL | | | | 1 | | | | 1 |
| SUI | 1 | | | 1 | | | | 2 |
| SVK | | | 1 | 1 | | 1 | | 3 |
| TJK | | 1 | 1 | 1 | | 1 | | 4 |
| TKM | 1 | 1 | 1 | | | | | 3 |
| TUR | 1 | 1 | 1 | 1 | 1 | 1 | 1 | 7 |
| UKR | 1 | 1 | 1 | 1 | 1 | 1 | 1 | 7 |
| URU | | | | 1 | | | | 1 |
| USA | 1 | 1 | 1 | 1 | 1 | 1 | 1 | 7 |
| UZB | 1 | 1 | 1 | 1 | 1 | 1 | 1 | 7 |
| VEN | | | | | 1 | | 1 | 2 |
| TOTAL | 33 | 34 | 35 | 35 | 33 | 33 | 28 | 231 |



Liste des Engagés par pays / Entry-List By Country

Senior World Championships

STYLE FS



ALBANIA (ALB)

Chef de délégation / Team Leader : BEZHANI, Viron

Entraîneur / Coach : TUSHA, Roland

Lutteur(s) / Wrestler(s) :

60 kg PRIZRENI, Sahit

ARGENTINA (ARG)

Chef de délégation / Team Leader : IGLESIAS, Daniel Alfredo

Entraîneur / Coach : BROSCHINI, Javier

Lutteur(s) / Wrestler(s) :

84 kg MAIER, Yuri Alexei Horacio

ARMENIA (ARM)

Lutteur(s) / Wrestler(s) :

55 kg BABAKHANYAN, Gegham

60 kg ARAKELYAN, Artur

66 kg HOVHANNISYAN, Zhirayr

74 kg MARKOSYAN, Suren

84 kg LALIEV, Vadim

96 kg YENOKYAN, Edgar

120 kg BASIEV, Ruslan

AUSTRALIA (AUS)

Chef de délégation / Team Leader : SAUL, John

Entraîneur / Coach : BABIRA, Leonid

Kiné / Medical Staff : SAFANIEV, Marc

Lutteur(s) / Wrestler(s) :

74 kg ERMAKOVICH, Konstantin

AUSTRIA (AUT)

Chef de délégation / Team Leader : OSTERMANN, Heinz

Entraîneur / Coach : KATONA, Geza

Médecin / Medical Staff : AICHNER, Alexander

Lutteur(s) / Wrestler(s) :

74 kg CREPAZ, Philipp



Liste des Engagés par pays / Entry-List By Country

Senior World Championships

STYLE FS



AZERBAIJAN (AZE)

| | |
|---|--|
| Chef de délégation / Team Leader : | RZAYEV, Yashar EYVAZOV, Tofig |
| Entraîneur / Coach : | ABSAIDOV, Saypulla UMUDOV, Firdovsi AGHAYEV, Aslan |
| Médecin / Medical Staff : | ZEYNALOV, Samir ALIYEVA, Asmar ALIYEV, Rauf |
| Kiné / Medical Staff : | ISMAYILOV, Seymour CHERNOVA, Yana ALIYEV, Khanoghlan |
| Lutteur(s) / Wrestler(s) : | |
| 55 kg | ASGAROV, Toghrul |
| 60 kg | HUSEYNOV, Zelimkhan |
| 66 kg | HASANOV, Jabrayil |
| 74 kg | CHAMSULVARAYEV, Chamsulvara |
| 84 kg | TEMREZOV, Nauruz |
| 96 kg | GAZYUMOV, Khetag |
| 120 kg | ISAYEV, Ali |

BELARUS (BLR)

| | |
|---|--|
| Chef de délégation / Team Leader : | TSITOU, Ivan MAJYDAU, Kamandar |
| Entraîneur / Coach : | MURZINKOU, V. HURYEU, S. KITAYOU, S. |
| Médecin / Medical Staff : | ZHUKOUSKI, A. SVADKOUSKAYA, K. YAKAULEU, Aliksandr |
| Kiné / Medical Staff : | HASPADARYK, A. MIKHAILOUSKI, Aliksandr |
| Lutteur(s) / Wrestler(s) : | |
| 55 kg | GADZHIEV, Rizvan |
| 60 kg | MAHAMEDAU, Mahamedkamil |
| 66 kg | BATYRAU, Albert |
| 74 kg | MATYL, Aliksandr |
| 84 kg | AMARHAJY, Mahamedau |
| 96 kg | SHEIKHAU, Ruslan |
| 120 kg | SHEMAROV, Alexei |



Liste des Engagés par pays / Entry-List By Country

Senior World Championships

STYLE FS



BRAZIL (BRA)

Lutteur(s) / Wrestler(s) :

120 kg

ABOU JAOUDE, Antoine Braga

BULGARIA (BUL)

Chef de délégation / Team Leader : JORDANOV, Valentin

Entraîneur / Coach : CHTEREV, Simeon

ANGELOV, Valentin

CHTEREV, Boyko

Médecin / Medical Staff : STRUGAROV, Stefan

DIMITROV, Stoyan

Kiné / Medical Staff : BAYAZIT, Mahmud

STANCHEV, Stancho

Lutteur(s) / Wrestler(s) :

55 kg

VELIKOV, Radoslav Marinov

60 kg

GUIDEA, Anatolie Ilarionovitch

66 kg

REDZHEP, Ismail Emin

74 kg

TERZIEV, Kiril Stoychev

84 kg

GANEV, Mihail Petrov

96 kg

ILIEV, Lyuben Borisov

120 kg

KUMCHEV, Dimitar Angelov

CAMEROON (CMR)

Lutteur(s) / Wrestler(s) :

55 kg

HENRY MOKI, Ndiva Molua

120 kg

ONANENA, Hugues Thiery

CANADA (CAN)

Chef de délégation / Team Leader : STEFOPOULOS, Chris

MEDWIDSKY, Tamara

Entraîneur / Coach : CALDER, Martin

MCKAY, David

ABDOU, Justin

Médecin / Medical Staff : NICHOLLS, Michael

BUDWAL, Surinder

Kiné / Medical Staff : SISSAOURI, Guivi

TKACH, Rick



Liste des Engagés par pays / Entry-List By Country

Senior World Championships

STYLE FS



Lutteur(s) / Wrestler(s) :

| | |
|--------|-------------------------|
| 55 kg | PINEDA, John Manuel |
| 60 kg | MANCINI, James |
| 66 kg | VERANES GARCIA, Haislan |
| 74 kg | GENTRY, Matthew Judah |
| 84 kg | BROWN, Donald |
| 96 kg | PLIEV, Khetag |
| 120 kg | BHULLAR, Arjan |

CHAD (CHA)

Entraîneur / Coach : AYOUBA, Abraham

Lutteur(s) / Wrestler(s) :

| | |
|-------|-----------------|
| 96 kg | ABATAM, Maurice |
|-------|-----------------|

CHINA (CHN)

Chef de délégation / Team Leader : LIU, Zhenduo
XUE, Lian
DONG, Shenghui

Entraîneur / Coach : YUAN, Haidong
XU, Xuanchong

Médecin / Medical Staff : YANG, Chao

Kiné / Medical Staff : ZHAO, Fan

Lutteur(s) / Wrestler(s) :

| | |
|--------|-----------------|
| 55 kg | QI, Mude |
| 60 kg | ZHANG, Xiaobin |
| 66 kg | SHAN, Chengde |
| 74 kg | ZHANG, Chongyao |
| 96 kg | WU, Yunbilige |
| 120 kg | DONG, Zhiwei |

CUBA (CUB)

Chef de délégation / Team Leader : PEREZ TELLEZ, Eduardo

Entraîneur / Coach : MORGAN SOROA, Barbaro
MENDIETA CUELLAR, Julio

Médecin / Medical Staff : MONTESINOS FLORES, Francisco

Lutteur(s) / Wrestler(s) :

| | |
|-------|----------------------------------|
| 55 kg | CHAMIZO MARQUEZ, Frank |
| 60 kg | VALDES TOBIER, Alejandro Enrique |



Liste des Engagés par pays / Entry-List By Country

Senior World Championships

STYLE FS



| | |
|-------|----------------------------------|
| 66 kg | GARZON CABALLERO, Jeandry |
| 74 kg | FUNDORA ZALDIVAR, Ivan |
| 84 kg | SALAS PEREZ, Reineris |
| 96 kg | BATISTA MARTINEZ, Michel Antonio |

CYPRUS (CYP)

Chef de délégation / Team Leader : LOUKA, Loukas

Entraîneur / Coach : APARYAN, Gagik

Lutteur(s) / Wrestler(s) :

| | |
|--------|------------------|
| 96 kg | PIERI, Andreas |
| 120 kg | VARNTAN, Aparian |

DOMINICA (DOM)

Entraîneur / Coach : MELLA SEGURA, Rafael

Lutteur(s) / Wrestler(s) :

| | |
|-------|--------------------------------|
| 60 kg | GARCIA SANCHEZ, Gabriel Arturo |
|-------|--------------------------------|

ECUADOR (ECU)

Lutteur(s) / Wrestler(s) :

| | |
|-------|----------------------|
| 66 kg | BLANCO REINOSO, Yoan |
|-------|----------------------|

EGYPT (EGY)

Lutteur(s) / Wrestler(s) :

| | |
|-------|-----------------------------------|
| 55 kg | FARAG, Ibrahim Abdelhakim Mohamed |
| 60 kg | IBRAHIM, Hassan Madany |
| 66 kg | ABDOU, Omar Ahmed |

ESTONIA (EST)

Chef de délégation / Team Leader : PRIIMAGI, Heino

LAND, Urmas

Entraîneur / Coach : JAANSON, Neeme

Médecin / Medical Staff : SARAPUU, Elar

PÄRNA, Lauri

Lutteur(s) / Wrestler(s) :

| | |
|-------|------------|
| 66 kg | HANI, Elar |
|-------|------------|



Liste des Engagés par pays / Entry-List By Country

Senior World Championships

STYLE FS



FINLAND (FIN)

| | |
|---|--------------------------|
| Chef de délégation / Team Leader : | RAUHALA, Jukka |
| Entraîneur / Coach : | RASKA, Ahto |
| Médecin / Medical Staff : | LEHTO, Mika |
| Kiné / Medical Staff : | NIEMI, Pentti |
| Lutteur(s) / Wrestler(s) : | |
| 60 kg | HYTTIAINEN, Jukka Ilmari |

FRANCE (FRA)

| | |
|---|---|
| Chef de délégation / Team Leader : | LASSUYE, François |
| Entraîneur / Coach : | BOURDIN, Thierry BERGER, Alain |
| Médecin / Medical Staff : | ROUGEE, Philippe VITALI, Eric |
| Kiné / Medical Staff : | ROUGEE, Guillaume BREARD, Jean GANGLOFF, Philippe |
| Lutteur(s) / Wrestler(s) : | |
| 55 kg | KAPLANBABA, Lokman |
| 60 kg | PAIS, Didier |
| 74 kg | LAMPIS, Luca Ezio |

GEORGIA (GEO)

| | |
|---|--|
| Chef de délégation / Team Leader : | GESTADZE, Kakha |
| Entraîneur / Coach : | TURMANIDZE, Zaza KAKHNIASHVILI, Aleksandre KHURTSIA, David |
| Médecin / Medical Staff : | KAKHABRISHVILI, Zurab |
| Kiné / Medical Staff : | KELEKHASHVILI, Jemal |
| Lutteur(s) / Wrestler(s) : | |
| 55 kg | GOCHASHVILI, Besarion |
| 60 kg | KURDIANI, Malkhaz |
| 66 kg | TUSHISHVILI, Otar |
| 74 kg | SAGIRASHVILI, Gela |
| 84 kg | MARSAGISHVILI, Dato |
| 96 kg | GOGSHELIDZE, George |
| 120 kg | BERIANIDZE, Levan |



Liste des Engagés par pays / Entry-List By Country

Senior World Championships

STYLE FS



GERMANY (GER)

Chef de délégation / Team Leader : SCHMENGLER, Detlef

Entraîneur / Coach : LEIPOLD, Alexander

GÜNDLING, Jens

SELIMOGLU, Behcet

Médecin / Medical Staff : GSTÖTTNER, Hans

KOLTZ, Christian

Kiné / Medical Staff : MARNETTE, Heinz

KRASS, Wnrer

FRANZ, Axel

Lutteur(s) / Wrestler(s) :

55 kg SCHLEICHER, Tim

60 kg EWALD, Marcel

66 kg DAUM, Martin Sebastian

74 kg SHYYKA, Andriy

84 kg BICHINASHVILI, Davyd

96 kg KESSEL, Johannes

GREAT BRITAIN (GBR)

Chef de délégation / Team Leader : MORLEY, Malcolm

Entraîneur / Coach : KORNIEIEV, Mykola

Lutteur(s) / Wrestler(s) :

55 kg KRASTANOV, Krasimir Vasilev

96 kg RATTIGAN, Leon Gregory

GREECE (GRE)

Chef de délégation / Team Leader : GALAKTOPOULOS, Petros

Entraîneur / Coach : MOUSTOPOULOS, Giorgis

APOSTOLOU, Nikos

Lutteur(s) / Wrestler(s) :

66 kg AKRITIDIS, Anastasios

74 kg MOTSALIN, Olegk

84 kg BENTINIDIS, Emzarios

96 kg PAPADOPOULOS, Ioannis

120 kg ARZOUMANIDIS, Ioannis

GUAM (GUM)



Liste des Engagés par pays / Entry-List By Country

Senior World Championships

STYLE FS



Lutteur(s) / Wrestler(s) :

66 kg MANIBUSAN, Melchor Vince

GUINEA-BISSAU (GBS)

Lutteur(s) / Wrestler(s) :

74 kg MIDANA, Augusto

HUNGARY (HUN)

Chef de délégation / Team Leader : MAROTHY, Istvan

Entraîneur / Coach : GULYAS, Istvan

Médecin / Medical Staff : BAKANEK, Gyorgy

Kiné / Medical Staff : HADI, Gegerly

Lutteur(s) / Wrestler(s) :

74 kg HATOS, Gábor

84 kg VERÉB, István

120 kg LIGETI, Dániel

INDIA (IND)

Entraîneur / Coach : MESTVIRISHVILI, Vladimer
G.S, Sanga

Kiné / Medical Staff : PERIVINKAL, Kaur
RAHUL, Shamra
GURPREET, Singh

Lutteur(s) / Wrestler(s) :

60 kg DUTT, Yogeshwar

66 kg SUSHIL, Kumar

74 kg YADAV, Narsingh Panoram

IRAN R.I. (IRI)

Chef de délégation / Team Leader : OLIA, Jafar

Entraîneur / Coach : MOHAMMADI, Gholamreza
KAVEH, M.
MEHRABAN, E.
DODANGEH, A.
DANGESARAKI, E.

Médecin / Medical Staff : AMIRSASAN, Ramin
TAHERI, Ali



Liste des Engagés par pays / Entry-List By Country

Senior World Championships

STYLE FS



Kiné / Medical Staff : REFETOV, Rais Behaydinov

Lutteur(s) / Wrestler(s) :

| | |
|--------|------------------------------|
| 55 kg | RAHIMI, Hassan Farman |
| 60 kg | MORAD MOHAMMADI, Seyed |
| 66 kg | TAGHAVI KERMANI, Mehdi |
| 74 kg | GOUDARZI, Sadegh Saeed |
| 84 kg | LASHGARI, Ehsan Naser |
| 96 kg | AMIRI, Arfan Moradali |
| 120 kg | MASOUMI VALADI, Fardin Papou |

ISRAEL (ISR)

Chef de délégation / Team Leader : TSITSIASHVILI, Gocha

Entraîneur / Coach : SHUSTERMAN, Grigoriy

Lutteur(s) / Wrestler(s) :

| | |
|-------|--------------|
| 66 kg | POLIAK, Yuri |
|-------|--------------|

ITALY (ITA)

Chef de délégation / Team Leader : ALBANESE, Aldo

Entraîneur / Coach : FINIZIO, Salvatore

Kiné / Medical Staff : PILOTTI, Pietro

Lutteur(s) / Wrestler(s) :

| | |
|-------|-----------------------------|
| 66 kg | CAMPAGNA, Raimondo |
| 84 kg | FASUGBA, Anthony Olamide Jr |

JAPAN (JPN)

Chef de délégation / Team Leader : MARUYAMA, Hideji

HASE, Hiroshi

Entraîneur / Coach : SATOH, Misturu

TANABE, Chikara

INOUE, Kenji

Médecin / Medical Staff : NAKAJIMA, Kohei

KOMATSU, Yutaka

Kiné / Medical Staff : TAKEUCHI, Tsuyoshi

KAWASAKI, Atsushi

Lutteur(s) / Wrestler(s) :

| | |
|-------|-----------------|
| 55 kg | INABA, Yasuhiro |
| 60 kg | ODA, Hiroyuki |



Liste des Engagés par pays / Entry-List By Country

Senior World Championships



STYLE FS

| | |
|--------|----------------------|
| 66 kg | YONEMITSU, Tatsuhiko |
| 74 kg | NAGASHIMA, Kazuyuki |
| 84 kg | MATSUMOTO, Atsushi |
| 96 kg | ISOKAWA, Takao |
| 120 kg | SHIMONAKA, Takahiro |

KAZAKHSTAN (KAZ)

Lutteur(s) / Wrestler(s) :

| | |
|--------|-----------------------|
| 55 kg | ZHANAKHANOV, Aslan |
| 60 kg | TELTAYEV, Abylay |
| 66 kg | TANATAROV, Akzhurek |
| 74 kg | SHAPIYEV, Abdulkhakim |
| 84 kg | BERDIYEV, Kanat |
| 96 kg | SHABANBAY, Daulet |
| 120 kg | MUTALIMOV, Marid |

KYRGYZSTAN (KGZ)

| | |
|---|--|
| Chef de délégation / Team Leader : | TURGANBAEV, Melis |
| Entraîneur / Coach : | USEMKANOV, Anrabek BEKBOLIEV, Saarbek |
| Médecin / Medical Staff : | ALISHEVA, Baktygul |
| Kiné / Medical Staff : | BATYRBEOV, A. |

Lutteur(s) / Wrestler(s) :

| | |
|--------|---------------------|
| 55 kg | ZAKHAROV, Mikhail |
| 60 kg | NADYRBEB UULU, Ulan |
| 96 kg | KRUPNYAKOV, Alexey |
| 120 kg | LAZAREV, Aiaal |

LATVIA (LAT)

| | |
|-----------------------------|---------------------|
| Entraîneur / Coach : | SMIRGAREVS, Andrejs |
|-----------------------------|---------------------|

Lutteur(s) / Wrestler(s) :

| | |
|--------|---------------------|
| 60 kg | VASILJEVS, Andrejs |
| 84 kg | ZVIRBULIS, Armands |
| 96 kg | AZAREVICS, Antans |
| 120 kg | MIHAILOVS, Dmitrijs |

LITHUANIA (LTU)



Liste des Engagés par pays / Entry-List By Country

Senior World Championships



STYLE FS

Chef de délégation / Team Leader : DAUMANTAS, Paulius

Médecin / Medical Staff : SKLIZMANTAS, Vladas

Lutteur(s) / Wrestler(s) :

55 kg JURCYS, Sarunas

MACEDONIA ANC. R. YUG (MKD)

Entraîneur / Coach : GLIGOROV, Strasho

Lutteur(s) / Wrestler(s) :

66 kg MITROV, Dejan

84 kg BOGDANOV, Dejan

96 kg GEORGIEV, Aleksandar

MADAGASCAR (MAD)

Lutteur(s) / Wrestler(s) :

55 kg ANDRIAMALALA, Bienvenu

MALTA (MLT)

Lutteur(s) / Wrestler(s) :

84 kg VASSALLO, Abraham

MOLDOVA (MDA)

Chef de délégation / Team Leader : CUCUL, Mihail

CORECENCOV, Victor

PEICOV, Victor

Entraîneur / Coach :

RUSU, Mihail

ORIOI, Nicolae

POLISHUK, Vladimir

Médecin / Medical Staff :

DERIVOLKOV, Alexandr

Kiné / Medical Staff :

CEREDNIK, Iurii

Lutteur(s) / Wrestler(s) :

55 kg CHIRTOACA, Alexandru

60 kg PERPELITA, Andrei

66 kg GOTISAN, Vladimir

74 kg DERMENJI, Roman

84 kg IANULOV, Piotr

96 kg CEBAN, Nicolai



Liste des Engagés par pays / Entry-List By Country

Senior World Championships

STYLE FS



120 kg

PODSEVALNICOV, Andrei

MONACO (MON)

Lutteur(s) / Wrestler(s) :

55 kg

TULBEA, Ghenadie

MONGOLIA (MGL)

Chef de délégation / Team Leader :

LKHAGVA, Chinbat

Entraîneur / Coach :

TSEDENSODNOM, Arslan

BYAMBARINCHIN, Bayaraa

BAYARSAIKHAN, Tsend

Médecin / Medical Staff :

CHULUUN, Nasanbat

Kiné / Medical Staff :

DAVAAJAV, Batnyam

Lutteur(s) / Wrestler(s) :

55 kg

BAYARAA, Naranbaatar

60 kg

ENKHSAIKHAN, Nyam Ochir

66 kg

BUYANJAV, Batzorig

74 kg

MYAGMAR, Mendsaikhan

84 kg

DORJVANCHIG, Tugjdorj

96 kg

YADAMSUREN, Altantulga

120 kg

JARGALSAIKHAN, Chuluunbat

NEW ZEALAND (NZL)

Entraîneur / Coach :

GRAYLING, Mark

Lutteur(s) / Wrestler(s) :

66 kg

PAULET, Sergiu Andrei

84 kg

HILL, Stephen Matthew

120 kg

LANE, Nicholas Spence

NIGERIA (NGR)

Chef de délégation / Team Leader :

EDEZE, Austin

Entraîneur / Coach :

IGALI, Daniel

Lutteur(s) / Wrestler(s) :

60 kg

DANIEL, Amas

96 kg

BOLTIC, Sinivie



Liste des Engagés par pays / Entry-List By Country

Senior World Championships

STYLE FS



POLAND (POL)

Lutteur(s) / Wrestler(s) :

| | |
|--------|---------------------------------|
| 55 kg | HAJDUK, Adrian Mariusz |
| 74 kg | BRZOZOWSKI, Krystian |
| 84 kg | BALAWENDER, Maciej Michal |
| 96 kg | BARAN, Radoslaw |
| 120 kg | BARTNICKI, Bartlomiej Wladyslaw |

PUERTO RICO (PUR)

Chef de délégation / Team Leader : GARCIA, Manuel

Entraîneur / Coach : ROJAS, Pedro

Lutteur(s) / Wrestler(s) :

| | |
|-------|-----------------------|
| 60 kg | GOMEZ MATOS, Franklin |
| 84 kg | ESPINAL, Jaime Yusept |

ROMANIA (ROU)

Entraîneur / Coach : GHITA, Nicolae

TOARCA, Petru

Médecin / Medical Staff : PLOESTEANU, Nicolae

Lutteur(s) / Wrestler(s) :

| | |
|-------|------------------------|
| 55 kg | DUKOV, Andrei |
| 60 kg | BUCUR, George |
| 66 kg | COJOCARU, Nicolae |
| 74 kg | ATOFANI, Marius Lucian |
| 84 kg | STEFAN, Gheorghita |

RUSSIA (RUS)

Lutteur(s) / Wrestler(s) :

| | |
|--------|------------------------|
| 55 kg | LEBEDEV, Victor |
| 60 kg | KUDUKHOV, Besik |
| 66 kg | GOGAEV, Alan |
| 74 kg | TSARGUSH, Denis |
| 84 kg | KTSOEV, Soslan |
| 96 kg | GATSALOV, Khadzhimurat |
| 120 kg | MAKHOV, Bilyal |



Liste des Engagés par pays / Entry-List By Country

Senior World Championships

STYLE FS



SENEGAL (SEN)

Entraîneur / Coach : AYAOKDO KODEI, Victor

Lutteur(s) / Wrestler(s) :

96 kg DIATTA, Aristide

SLOVAKIA (SVK)

Lutteur(s) / Wrestler(s) :

66 kg KACENAK, Jakub

74 kg BABRNAK, Dusan

96 kg JALOVIAR, Jozef

SOLOMON ISLANDS (SOL)

Lutteur(s) / Wrestler(s) :

74 kg UERESI, Katea

SOUTH AFRICA (RSA)

Chef de délégation / Team Leader : PUTTER, Willem

Entraîneur / Coach : COETZEE, Nico

Lutteur(s) / Wrestler(s) :

66 kg BARNES, Heinrich

74 kg ADDINALL, Richard Brian

84 kg MEYER, Gerald Waldemar

96 kg VAN HUYSSTEEN, Etienne

SOUTH KOREA (KOR)

Chef de délégation / Team Leader : KIM, Hae-Jin

Entraîneur / Coach : CHIN, Hyung-Kyun

Lutteur(s) / Wrestler(s) :

55 kg KIM, Hyo-Sub

60 kg LEE, Seung-Chul

66 kg KIM, Dai-Sung

74 kg LEE, Yun-Seok

84 kg LEE, Jae-Sung

96 kg KIM, Jae-Gang



Liste des Engagés par pays / Entry-List By Country

Senior World Championships

STYLE FS



SPAIN (ESP)

Chef de délégation / Team Leader : JAVIER IGLESIAS, Francisco

Entraîneur / Coach : CACERES, Vicente

Lutteur(s) / Wrestler(s) :

| | |
|--------|---------------------------------|
| 55 kg | SANCHEZ PARRA, Francisco Javier |
| 60 kg | SANCHEZ PARRA, Agustin |
| 84 kg | ANDONOV LAZAROV, Boris |
| 120 kg | CUBA VAZQUEZ, Jose |

SWITZERLAND (SUI)

Entraîneur / Coach : KUNG, Ludwig

Lutteur(s) / Wrestler(s) :

| | |
|-------|---------------------|
| 55 kg | WILD, Urs |
| 74 kg | RIESEN, Marco Lukas |

TAJIKISTAN (TJK)

Lutteur(s) / Wrestler(s) :

| | |
|-------|-------------------|
| 60 kg | KORYAKIN, Vitaly |
| 66 kg | SHARIPOV, GULOM |
| 74 kg | RAKHMATOR, Ali |
| 96 kg | ANAKULOV, Farkhod |

TURKEY (TUR)

Chef de délégation / Team Leader : YILDIZ, Ercan

CAKIR, Mustafa

GENC, Mehmet

Entraîneur / Coach : ARBAYHANOV, Isak

BEREKET, Adem

CEYLAN, Turan

ATMACA, Murat

Médecin / Medical Staff : GUNES, Elif

SAVRANBASI, Ramazan

Kiné / Medical Staff : AKSAKAL, Suat

CELIK, Ahmet

Lutteur(s) / Wrestler(s) :

| | |
|-------|--------------|
| 55 kg | AKGUL, Sezar |
| 60 kg | CETIN, Ersin |



Liste des Engagés par pays / Entry-List By Country

Senior World Championships



STYLE FS

| | |
|--------|-------------------|
| 66 kg | SAHIN, Ramazan |
| 74 kg | DEMIRCIN, Batuhan |
| 84 kg | YAVASER, Gokhan |
| 96 kg | BALCI, Serhat |
| 120 kg | CAKIROGLU, Fatih |

TURKMENISTAN (TKM)

Lutteur(s) / Wrestler(s) :

| | |
|-------|-------------------|
| 55 kg | REJEPOV, Ramil |
| 60 kg | CAPYYEV, Silap |
| 66 kg | KAMBAROV, Ramazan |

UKRAINE (UKR)

Chef de délégation / Team Leader : NOSADCHYY, Eduard
KOMARNYTSKA, Tetiana

Entraîneur / Coach : SAVLOKHOV, Ruslan
GREK, Ignat
KHARENKO, Dina

Médecin / Medical Staff : KURINNAYA, Iryna
MOSKALENKO, Oleksandr
SHVANGYRADZE, Merab

Kiné / Medical Staff : GULKHARIEV, Igor
PARNAK, Andriy
NAZARENKO, Yuriy

Lutteur(s) / Wrestler(s) :

| | |
|--------|---------------------|
| 55 kg | RATUSHNIY, Serguei |
| 60 kg | FEDORYSHYN, Vasyl |
| 66 kg | STADNIK, Andriy |
| 74 kg | SYROTYN, Volodymyr |
| 84 kg | ALDATOV, Ibragim |
| 96 kg | ANDRIITSEV, Valerii |
| 120 kg | TASOIEV, Vadym |

UNITED STATES (USA)

Lutteur(s) / Wrestler(s) :

| | |
|-------|-----------------------|
| 55 kg | BLANC, Obenson |
| 60 kg | ZADICK, Michael |
| 66 kg | METCALF, Brent Harold |



Liste des Engagés par pays / Entry-List By Country

Senior World Championships

STYLE FS



| | |
|--------|------------------------|
| 74 kg | PAULSON, Travis Eugene |
| 84 kg | HERBERT, Jacob John |
| 96 kg | BERGMAN, James Daniel |
| 120 kg | SIGMAN, Les |

URUGUAY (URU)

Entraîneur / Coach : REX, Febus

Lutteur(s) / Wrestler(s) :

74 kg UTHURBURU FERNANDEZ, Daniel

UZBEKISTAN (UZB)

Chef de délégation / Team Leader : ABDUVALIYEV, Salim

TURSUNOV, Botir

Entraîneur / Coach :

ACHILOV, Adkhamjon

Médecin / Medical Staff :

ABAEVA, Elena

Kiné / Medical Staff :

BIKTYAKOV, Ravil

Lutteur(s) / Wrestler(s) :

| | |
|--------|---------------------|
| 55 kg | QURBANOV, Nasibullo |
| 60 kg | MANSUROV, Dilshod |
| 66 kg | NAVRUZOV, Ikhtiyor |
| 74 kg | BAZARBAEV, Abdurauf |
| 84 kg | SOKHIEV, Zaurbek |
| 96 kg | KURBANOV, Kurban |
| 120 kg | TAYMAZOV, Artur |

VENEZUELA (VEN)

Lutteur(s) / Wrestler(s) :

| | |
|--------|-------------------------------|
| 84 kg | ROBERTTY MORENO, Ricardo |
| 120 kg | VIVENES URBANEJA, Luis Felipe |



Feuille de compétition / Competition Sheet

Senior World Championships



WORLD WRESTLING
FEDERATION
CHAMPIONSHIP

STYLE : FS 55 kg

| QUALIFICATION | | | 1/16 Finale | | | 1/8 FINALE | | | | |
|---------------|--------------------------|----------|-------------|------|--------------------------|------------|----|------|--------------------------|----------|
| 1 | JURCYS Sarunas (LTU) | P1 P2 P3 | 1 | 3/11 | JURCYS Sarunas (LTU) | P1 P2 P3 | 1 | 0/0 | LTU | P1 P2 P3 |
| 2 | ANDRIAMALALA B. (MAD) | P1 P2 P3 | 2 | 1/2 | ANDRIAMALALA B. (MAD) | P1 P2 P3 | 4 | 4/13 | KOR | P1 P2 P3 |
| 3 | KAPLANBABA Lokman (FRA) | P1 P2 P3 | 3 | 1/2 | KAPLANBABA Lokman (FRA) | P1 P2 P3 | 6 | 0/0 | BUL | P1 P2 P3 |
| 4 | KIM Hyo-Sub (KOR) | P1 P2 P3 | 4 | 3/7 | KIM Hyo-Sub (KOR) | P1 P2 P3 | 8 | 3/10 | RUS | P1 P2 P3 |
| 5 | DUKOV Andrei (ROU) | P1 P2 P3 | 5 | 0/5 | DUKOV Andrei (ROU) | P1 P2 P3 | 10 | 1/1 | GEO | P1 P2 P3 |
| 6 | VELIKOV R. (BUL) | P1 P2 P3 | 6 | 5/4 | VELIKOV R. (BUL) | P1 P2 P3 | 11 | 3/3 | IRI | P1 P2 P3 |
| 7 | QURBANOV Nasibullo (UZB) | P1 P2 P3 | 7 | 0/0 | QURBANOV Nasibullo (UZB) | P1 P2 P3 | 12 | 0/0 | HAJDUK A. (POL) | P1 P2 P3 |
| 8 | LEBEDEV Victor (RUS) | P1 P2 P3 | 8 | 3/4 | LEBEDEV Victor (RUS) | P1 P2 P3 | 13 | 1/2 | KRASTANOV K. (GBR) | P1 P2 P3 |
| 9 | QI Mude (CHN) | P1 P2 P3 | 9 | 0/0 | QI Mude (CHN) | P1 P2 P3 | 14 | 3/4 | CHAMIZO MARQUEZ F. (CUB) | P1 P2 P3 |
| 10 | GOCHASHVILI B. (GEO) | P1 P2 P3 | 10 | 3/3 | GOCHASHVILI B. (GEO) | P1 P2 P3 | 15 | 3/4 | RATUSHNIY Serguei (UKR) | P1 P2 P3 |
| 11 | RAHIMI H. (IRI) | P1 P2 P3 | 11 | 3/2 | RAHIMI H. (IRI) | P1 P2 P3 | 16 | 0/0 | BABAKHANYAN Gegham (ARM) | P1 P2 P3 |
| 12 | HAJDUK A. (POL) | P1 P2 P3 | 12 | 0/0 | HAJDUK A. (POL) | P1 P2 P3 | 17 | 0/0 | HENRY MOKI N. (CMR) | P1 P2 P3 |
| 13 | KRASTANOV K. (GBR) | P1 P2 P3 | 13 | 1/2 | KRASTANOV K. (GBR) | P1 P2 P3 | 18 | 4/13 | ASGAROV Toghrl (AZE) | P1 P2 P3 |
| 14 | CHAMIZO MARQUEZ F. (CUB) | P1 P2 P3 | 14 | 3/4 | CHAMIZO MARQUEZ F. (CUB) | P1 P2 P3 | 19 | 0/0 | ZAKHAROV Mikhail (KGZ) | P1 P2 P3 |
| 15 | RATUSHNIY Serguei (UKR) | P1 P2 P3 | 15 | 3/4 | RATUSHNIY Serguei (UKR) | P1 P2 P3 | 20 | 0/2 | MGL | P1 P2 P3 |
| 16 | BABAKHANYAN Gegham (ARM) | P1 P2 P3 | 16 | 1/2 | BABAKHANYAN Gegham (ARM) | P1 P2 P3 | 21 | 3/5 | BAYARAA N. (MGL) | P1 P2 P3 |
| 17 | HENRY MOKI N. (CMR) | P1 P2 P3 | 17 | 0/0 | HENRY MOKI N. (CMR) | P1 P2 P3 | 22 | 3/6 | GADZHIEV Rizvan (BLR) | P1 P2 P3 |
| 18 | ASGAROV Toghrl (AZE) | P1 P2 P3 | 18 | 4/13 | ASGAROV Toghrl (AZE) | P1 P2 P3 | 23 | 1/4 | TULBEA Ghenadie (MON) | P1 P2 P3 |
| 19 | ZAKHAROV Mikhail (KGZ) | P1 P2 P3 | 19 | 0/0 | ZAKHAROV Mikhail (KGZ) | P1 P2 P3 | 24 | 0/0 | REJEPOV Ramil (TKM) | P1 P2 P3 |
| 20 | BAYARAA N. (MGL) | P1 P2 P3 | 20 | 3/5 | BAYARAA N. (MGL) | P1 P2 P3 | 25 | 1/4 | CHIRTOACA A. (MDA) | P1 P2 P3 |
| 21 | GADZHIEV Rizvan (BLR) | P1 P2 P3 | 21 | 3/6 | GADZHIEV Rizvan (BLR) | P1 P2 P3 | 26 | 0/0 | WILD Urs (SUI) | P1 P2 P3 |
| 22 | TULBEA Ghenadie (MON) | P1 P2 P3 | 22 | 1/4 | TULBEA Ghenadie (MON) | P1 P2 P3 | 27 | 5/3 | AKGUL Sezar (TUR) | P1 P2 P3 |
| 23 | REJEPOV Ramil (TKM) | P1 P2 P3 | 23 | 0/0 | REJEPOV Ramil (TKM) | P1 P2 P3 | 28 | 0/0 | BLANC Obenson (USA) | P1 P2 P3 |
| 24 | CHIRTOACA A. (MDA) | P1 P2 P3 | 24 | 3/6 | CHIRTOACA A. (MDA) | P1 P2 P3 | 29 | 3/3 | SANCHEZ PARRA F. (ESP) | P1 P2 P3 |
| 25 | WILD Urs (SUI) | P1 P2 P3 | 25 | 0/0 | WILD Urs (SUI) | P1 P2 P3 | 30 | 0/0 | PINEDA John Manuel (CAN) | P1 P2 P3 |
| 26 | AKGUL Sezar (TUR) | P1 P2 P3 | 26 | 5/3 | AKGUL Sezar (TUR) | P1 P2 P3 | 31 | 4/14 | INABA Yasuhiro (JPN) | P1 P2 P3 |
| 27 | BLANC Obenson (USA) | P1 P2 P3 | 27 | 0/0 | BLANC Obenson (USA) | P1 P2 P3 | 32 | 3/3 | ZHANAKHANOV Aslan (KAZ) | P1 P2 P3 |
| 28 | SANCHEZ PARRA F. (ESP) | P1 P2 P3 | 28 | 3/3 | SANCHEZ PARRA F. (ESP) | P1 P2 P3 | 33 | 1/4 | SCHLEICHER Tim (GER) | P1 P2 P3 |
| 29 | PINEDA John Manuel (CAN) | P1 P2 P3 | 29 | 0/0 | SANCHEZ PARRA F. (ESP) | P1 P2 P3 | | | | |
| 30 | INABA Yasuhiro (JPN) | P1 P2 P3 | 30 | 3/5 | PINEDA John Manuel (CAN) | P1 P2 P3 | | | | |
| 31 | FARAG I. (EGY) | P1 P2 P3 | 31 | 0/0 | INABA Yasuhiro (JPN) | P1 P2 P3 | | | | |
| 32 | ZHANAKHANOV Aslan (KAZ) | P1 P2 P3 | 32 | 0/0 | ZHANAKHANOV Aslan (KAZ) | P1 P2 P3 | | | | |
| 33 | SCHLEICHER Tim (GER) | P1 P2 P3 | 33 | 1/4 | SCHLEICHER Tim (GER) | P1 P2 P3 | | | | |



Feuille de compétition / Competition Sheet

Senior World Championships

STYLE : FS 55 kg



WORLD WRESTLING
FEDERATION
CHAMPIONSHIP



Classement

| Cl | Pays | Nom |
|----|------|----------------------------|
| 1 | RUS | LEBEDEV Victor |
| 2 | AZE | ASGAROV Toghrul |
| 3 | CUB | CHAMIZO MARQUEZ Frank |
| 3 | JPN | INABA Yasuhiro |
| 5 | KOR | KIM Hyo-Sub |
| 5 | MGL | BAYARAA Naranbaatar |
| 7 | BUL | VELIKOV Radoslav Marinov |
| 8 | BLR | GADZHIEV Rizvan |
| 9 | USA | BLANC Obenson |
| 10 | IRI | RAHIMI Hassan Farman |
| 11 | SUI | WILD Urs |
| 12 | MDA | CHIRTOACA Alexandru |
| 13 | CAN | PINEDA John Manuel |
| 14 | GEO | GOCHASHVILI Besarion |
| 15 | LTU | JURCYS Sarunas |
| 16 | KAZ | ZHANAKHANOV Aslan |
| 17 | UKR | RATUSHNIY Serguei |
| 18 | MON | TULBEA Ghenadie |
| 19 | GER | SCHLEICHER Tim |
| 20 | GBR | KRASTANOV Krasimir Vasilev |

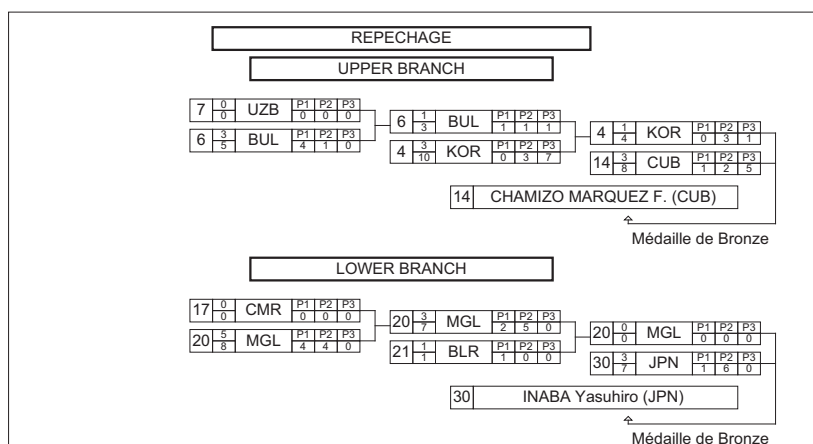



Classement

Senior World Championships

STYLE : FS 55 kg



1 - Or / Gold



LEBEDEV Victor

2 - Argent / Silver



ASGAROV Toghrul

3 - Bronze



CHAMIZO MARQUEZ Frank



INABA Yasuhiro

| Classement | Nom - Name | Pays - Country |
|------------|----------------------------------|----------------|
| 1 | LEBEDEV Victor | RUS |
| 2 | ASGAROV Toghrul | AZE |
| 3 | CHAMIZO MARQUEZ F. | CUB |
| 3 | INABA Yasuhiro | JPN |
| 5 | KIM Hyo-Sub | KOR |
| 5 | BAYARAA Naranbaatar | MGL |
| 7 | VELIKOV Radoslav Marinov | BUL |
| 8 | GADZHIEV Rizvan | BLR |
| 9 | BLANC Obenson | USA |
| 10 | RAHIMI Hassan Farman | IRI |
| 11 | WILD Urs | SUI |
| 12 | CHIRTOACA Alexandru | MDA |
| 13 | PINEDA John Manuel | CAN |
| 14 | GOCHASHVILI Besarion | GEO |
| 15 | JURCYS Sarunas | LTU |
| 16 | ZHANAKHANOV Aslan | KAZ |
| 17 | RATUSHNIY Serguei | UKR |
| 18 | TULBEA Ghenadie | MON |
| 19 | SCHLEICHER Tim | GER |
| 20 | KRASTANOV Krasimir Vasilev | GBR |
| 20 | BABAKHANYAN Gegham | ARM |
| 22 | KAPLANBABA Lokman | FRA |
| 23 | ANDRIAMALALA Bienvenu | MAD |
| 24 | FARAG Ibrahim Abdelhakim Mohamed | EGY |
| 25 | DUKOV Andrei | ROU |
| 26 | HAJDUK Adrian Mariusz | POL |
| 27 | QI Mude | CHN |
| 27 | AKGUL Sezar | TUR |
| 29 | SANCHEZ PARRA Francisco Javier | ESP |
| 29 | ZAKHAROV Mikhail | KGZ |



Classement

Senior World Championships

STYLE : FS 55 kg



WORLD WRESTLING
MAY 2016 - 16-17 SEPTEMBER 2016
CHAMPIONSHIP

| <i>Classement</i> | <i>Nom - Name</i> | <i>Pays - Country</i> |
|-------------------|------------------------|-----------------------|
| 31 | REJEPOV Ramil | TKM |
| 32 | QURBANOV Nasibullo | UZB |
| 33 | HENRY MOKI Ndiva Molua | CMR |



Feuille de compétition / Competition Sheet

Senior World Championships



WORLD WRESTLING
FEDERATION
CHAMPIONSHIP

STYLE : FS 60 kg

| QUALIFICATION | | | | 1/16 Finale | | | | 1/8 FINALE | | | |
|---------------|-----|--------------------------|-------------------|-------------|------|--------------------------|-------------------|------------|------|--------------------------|-------------------|
| 1 | 3/7 | ARAKELYAN Artur (ARM) | P1 P2 P3 1 6 0 | 1 | 3/6 | ARAKELYAN Artur (ARM) | P1 P2 P3 2 4 0 | 1 | 1/2 | ARM | P1 P2 P3 0 2 0 |
| 2 | 3/7 | SANCHEZ PARRA A. (ESP) | P1 P2 P3 1 6 0 | 2 | 0/0 | SANCHEZ PARRA A. (ESP) | P1 P2 P3 0 0 0 | 2 | 3/6 | RUS | P1 P2 P3 1 5 0 |
| 3 | 3/7 | PAIS Didier (FRA) | P1 P2 P3 1 6 0 | 3 | 0/0 | PAIS Didier (FRA) | P1 P2 P3 0 0 0 | 3 | 1/4 | MGL | P1 P2 P3 3 1 0 |
| 4 | 3/7 | KUDUKHOV Besik (RUS) | P1 P2 P3 1 6 0 | 4 | 3/4 | KUDUKHOV Besik (RUS) | P1 P2 P3 1 3 0 | 4 | 3/6 | IRI | P1 P2 P3 3 3 0 |
| 5 | 3/7 | ODA Hiroyuki (JPN) | P1 P2 P3 1 6 0 | 5 | 1/1 | ODA Hiroyuki (JPN) | P1 P2 P3 0 1 0 | 5 | 1/2 | MDA | P1 P2 P3 2 0 0 |
| 6 | 3/7 | ENKHSАIKHAN N. (MGL) | P1 P2 P3 1 6 0 | 6 | 3/2 | ENKHSАIKHAN N. (MGL) | P1 P2 P3 1 0 1 | 6 | 3/5 | KOR | P1 P2 P3 0 1 4 |
| 7 | 3/7 | NADYRBEK UULU Ulan (KGZ) | P1 P2 P3 1 6 0 | 7 | 3/2 | NADYRBEK UULU Ulan (KGZ) | P1 P2 P3 0 1 1 | 7 | 1/1 | CHN | P1 P2 P3 1 0 0 |
| 8 | 3/7 | EWALD Marcel (GER) | P1 P2 P3 1 6 0 | 8 | 1/1 | EWALD Marcel (GER) | P1 P2 P3 1 0 0 | 8 | 3/5 | TUR | P1 P2 P3 3 2 0 |
| 9 | 3/7 | MORAD MOHAMMADI S. (IRI) | P1 P2 P3 1 6 0 | 9 | 3/5 | MORAD MOHAMMADI S. (IRI) | P1 P2 P3 4 1 0 | 9 | 1/1 | KAZ | P1 P2 P3 2 0 0 |
| 10 | 3/7 | MAHAMEDAU M. (BLR) | P1 P2 P3 1 6 0 | 10 | 1/2 | MAHAMEDAU M. (BLR) | P1 P2 P3 1 1 0 | 10 | 3/7 | AZE | P1 P2 P3 5 2 0 |
| 11 | 3/7 | IBRAHIM H. (EGY) | P1 P2 P3 1 6 0 | 11 | 0/0 | IBRAHIM H. (EGY) | P1 P2 P3 0 0 0 | 11 | 1/2 | BUL | P1 P2 P3 0 0 0 |
| 12 | 3/7 | PERPELITA Andrei (MDA) | P1 P2 P3 1 6 0 | 12 | 3/9 | PERPELITA Andrei (MDA) | P1 P2 P3 3 6 0 | 12 | 3/7 | AZE | P1 P2 P3 5 2 0 |
| 13 | 3/7 | LEE Seung-Chul (KOR) | P1 P2 P3 1 6 0 | 13 | 3/5 | LEE Seung-Chul (KOR) | P1 P2 P3 3 2 0 | 13 | 1/4 | NGR | P1 P2 P3 2 2 0 |
| 14 | 3/7 | ZADICK Michael (USA) | P1 P2 P3 1 6 0 | 14 | 1/1 | ZADICK Michael (USA) | P1 P2 P3 1 0 0 | 14 | 3/10 | DANIEL Amas (NGR) | P1 P2 P3 6 4 0 |
| 15 | 3/7 | ZHANG Xiaobin (CHN) | P1 P2 P3 1 6 0 | 15 | 3/2 | ZHANG Xiaobin (CHN) | P1 P2 P3 1 1 0 | 15 | 1/1 | CHN | P1 P2 P3 1 0 0 |
| 16 | 3/7 | CAPYYEV Silap (TKM) | P1 P2 P3 1 6 0 | 16 | 0/0 | CAPYYEV Silap (TKM) | P1 P2 P3 0 0 0 | 16 | 3/5 | TUR | P1 P2 P3 3 2 0 |
| 17 | 3/7 | CETIN Ersin (TUR) | P1 P2 P3 1 6 0 | 17 | 3/6 | CETIN Ersin (TUR) | P1 P2 P3 4 2 0 | 17 | 1/1 | CHN | P1 P2 P3 1 0 0 |
| 18 | 3/7 | HYTTIAINEN J. (FIN) | P1 P2 P3 1 6 0 | 18 | 1/1 | HYTTIAINEN J. (FIN) | P1 P2 P3 0 1 0 | 18 | 3/3 | TELТAYEV Abylay (KAZ) | P1 P2 P3 1 2 0 |
| 19 | 3/7 | TELТAYEV Abylay (KAZ) | P1 P2 P3 1 6 0 | 19 | 3/3 | TELТAYEV Abylay (KAZ) | P1 P2 P3 1 2 0 | 19 | 1/2 | KAZ | P1 P2 P3 2 0 0 |
| 20 | 3/7 | KORYAKIN Vitaly (TJK) | P1 P2 P3 1 6 0 | 20 | 0/0 | KORYAKIN Vitaly (TJK) | P1 P2 P3 0 0 0 | 20 | 3/4 | FEDORYSHYN Vasyl (UKR) | P1 P2 P3 0 1 3 |
| 21 | 3/7 | FEDORYSHYN Vasyl (UKR) | P1 P2 P3 1 6 0 | 21 | 3/4 | FEDORYSHYN Vasyl (UKR) | P1 P2 P3 0 1 3 | 21 | 3/5 | UKR | P1 P2 P3 3 0 2 |
| 22 | 3/7 | MANSUROV Dilshod (UZB) | P1 P2 P3 1 6 0 | 22 | 1/1 | MANSUROV Dilshod (UZB) | P1 P2 P3 1 0 0 | 22 | 1/1 | CHN | P1 P2 P3 1 0 0 |
| 23 | 3/7 | KURDIANI Malkhaz (GEO) | P1 P2 P3 1 6 0 | 23 | 3/4 | KURDIANI Malkhaz (GEO) | P1 P2 P3 2 2 0 | 23 | 1/2 | GEO | P1 P2 P3 0 1 1 |
| 24 | 3/7 | GOMEZ MATOS F. (PUR) | P1 P2 P3 1 6 0 | 24 | 1/2 | GOMEZ MATOS F. (PUR) | P1 P2 P3 2 0 0 | 24 | 3/7 | AZE | P1 P2 P3 5 2 0 |
| 25 | 3/7 | DANIEL Amas (NGR) | P1 P2 P3 1 6 0 | 25 | 3/10 | DANIEL Amas (NGR) | P1 P2 P3 6 4 0 | 25 | 1/4 | NGR | P1 P2 P3 2 2 0 |
| 26 | 3/7 | VASILJEVS Andrejs (LAT) | P1 P2 P3 1 6 0 | 26 | 0/0 | VASILJEVS Andrejs (LAT) | P1 P2 P3 0 0 0 | 26 | 3/5 | HUSEYNOV Zelimkhan (AZE) | P1 P2 P3 1 4 0 |
| 27 | 3/7 | HUSEYNOV Zelimkhan (AZE) | P1 P2 P3 1 6 0 | 27 | 3/5 | HUSEYNOV Zelimkhan (AZE) | P1 P2 P3 1 4 0 | 27 | 1/1 | CHN | P1 P2 P3 1 0 0 |
| 28 | 3/7 | BUCUR George (ROU) | P1 P2 P3 1 6 0 | 28 | 1/1 | BUCUR George (ROU) | P1 P2 P3 0 1 0 | 28 | 3/7 | AZE | P1 P2 P3 5 2 0 |
| 29 | 3/7 | GUIDEA A. (BUL) | P1 P2 P3 1 6 0 | 29 | 3/6 | GUIDEA A. (BUL) | P1 P2 P3 2 4 0 | 29 | 1/0 | BUL | P1 P2 P3 0 0 0 |
| 30 | 3/7 | MANCINI James (CAN) | P1 P2 P3 1 6 0 | 30 | 0/0 | MANCINI James (CAN) | P1 P2 P3 0 0 0 | 30 | 3/2 | VALDES TOBIER A. (CUB) | P1 P2 P3 1 1 0 |
| 31 | 3/7 | PRIZRENI Sahit (ALB) | P1 P2 P3 2 5 0 | 31 | 0/0 | PRIZRENI Sahit (ALB) | P1 P2 P3 0 0 0 | 31 | 3/4 | GARCIA SANCHEZ G. (DOM) | P1 P2 P3 0 0 0 |
| 32 | 1/2 | DUTT Yogeshwar (IND) | P1 P2 P3 0 2 0 | 32 | 0/0 | DUTT Yogeshwar (IND) | P1 P2 P3 0 0 0 | 32 | 3/2 | CUB | P1 P2 P3 1 1 0 |
| 33 | 3/8 | VALDES TOBIER A. (CUB) | P1 P2 P3 7 1 0 | 33 | 3/4 | VALDES TOBIER A. (CUB) | P1 P2 P3 1 3 0 | | | | |
| 34 | 0/0 | GARCIA SANCHEZ G. (DOM) | P1 P2 P3 0 0 0 | | | | | | | | |



Feuille de compétition / Competition Sheet

Senior World Championships

STYLE : FS 60 kg



Classement

| Cl | Pays | Nom |
|----|------|---------------------------------|
| 1 | RUS | KUDUKHOV Besik |
| 2 | UKR | FEDORYSHYN Vasyl |
| 3 | IRI | MORAD MOHAMMADI Seyed |
| 3 | AZE | HUSEYNOV Zelimkhan |
| 5 | KGZ | NADYRBEK UULU Ulan |
| 5 | TUR | CETIN Ersin |
| 7 | CUB | VALDES TOBIER Alejandro Enrique |
| 8 | KOR | LEE Seung-Chul |
| 9 | GEO | KURDIANI Malkhaz |
| 10 | ARM | ARAKELYAN Artur |
| 11 | NGR | DANIEL Amas |
| 12 | MDA | PERPELITA Andrei |
| 13 | FRA | PAIS Didier |
| 14 | BUL | GUIDEA Anatolie Ilarionovitch |
| 15 | MGL | ENKHTSAIKHAN Nyam Ochir |
| 16 | KAZ | TELTAJEV Abylay |
| 17 | CHN | ZHANG Xiaobin |
| 18 | ALB | PRIZRENI Sahit |
| 19 | UZB | MANSUROV Dilshod |
| 20 | PUR | GOMEZ MATOS Franklin |

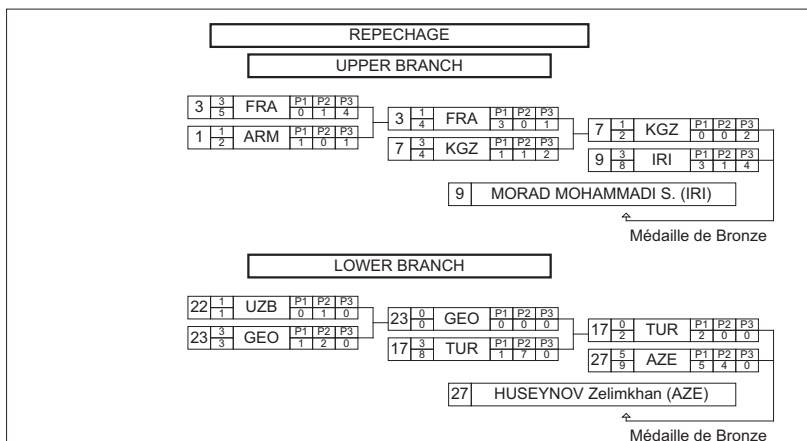



Classement

Senior World Championships



STYLE : FS 60 kg

1 - Or / Gold



KUDUKHOV Besik

2 - Argent / Silver



FEDORYSHYN Vasyl

3 - Bronze



MORAD MOHAMMADI Seyed HUSEYNOV Zelimkhan

| <i>Classement</i> | <i>Nom - Name</i> | <i>Pays - Country</i> |
|-------------------|---------------------------------|-----------------------|
| 1 | KUDUKHOV Besik | RUS |
| 2 | FEDORYSHYN Vasyl | UKR |
| 3 | MORAD MOHAMMADI S. | IRI |
| 3 | HUSEYNOV Zelimkhan | AZE |
| 5 | NADYRBEK UULU Ulan | KGZ |
| 5 | CETIN Ersin | TUR |
| 7 | VALDES TOBIER Alejandro Enrique | CUB |
| 8 | LEE Seung-Chul | KOR |
| 9 | KURDIANI Malkhaz | GEO |
| 10 | ARAKELYAN Artur | ARM |
| 11 | DANIEL Amas | NGR |
| 12 | PERPELITA Andrei | MDA |
| 13 | PAIS Didier | FRA |
| 14 | GUIDEA Anatolie Ilarionovitch | BUL |
| 15 | ENKHSAIKHAN Nyam Ochir | MGL |
| 16 | TELTAYEV Abylay | KAZ |
| 17 | ZHANG Xiaobin | CHN |
| 18 | PRIZRENI Sahit | ALB |
| 19 | MANSUROV Dilshod | UZB |
| 20 | GOMEZ MATOS Franklin | PUR |
| 21 | MAHAMEDAU Mahamedkamil | BLR |
| 22 | DUTT Yogeshwar | IND |
| 23 | ODA Hiroyuki | JPN |
| 23 | EWALD Marcel | GER |
| 25 | BUCUR George | ROU |
| 25 | ZADICK Michael | USA |
| 27 | HYTTIAINEN Jukka Ilmari | FIN |
| 28 | CAPYYEV Silap | TKM |
| 29 | KORYAKIN Vitaly | TJK |
| 30 | MANCINI James | CAN |
| 30 | SANCHEZ PARRA Agustin | ESP |



Classement

Senior World Championships

STYLE : FS 60 kg



| <i>Classement</i> | <i>Nom - Name</i> | <i>Pays - Country</i> |
|-------------------|-------------------------------|-----------------------|
| 32 | GARCIA SANCHEZ Gabriel Arturo | DOM |
| 33 | IBRAHIM Hassan Madany | EGY |
| 34 | VASILJEVS Andrejs | LAT |



Feuille de compétition / Competition Sheet

Senior World Championships



WORLD WRESTLING
FEDERATION
CHAMPIONSHIP

STYLE : FS 66 kg

| QUALIFICATION | | | | 1/16 Finale | | | | 1/8 FINALE | | | |
|---------------|------|---------------------------|-------------------|-------------|------|---------------------------|-------------------|------------|------|-----|-------------------|
| 1 | 5/9 | REDZHEP I. (BUL) | P1 P2 P3 5 4 0 | 1 | 5/8 | REDZHEP I. (BUL) | P1 P2 P3 1 7 0 | 1 | 0/0 | BUL | P1 P2 P3 0 0 0 |
| 2 | 5/9 | CAMPAGNA Raimondo (ITA) | P1 P2 P3 5 4 0 | 2 | 0/6 | CAMPAGNA Raimondo (ITA) | P1 P2 P3 3 3 0 | 2 | 0/0 | | |
| 3 | 5/9 | BARNES Heinrich (RSA) | P1 P2 P3 5 4 0 | 3 | 4/13 | BARNES Heinrich (RSA) | P1 P2 P3 7 6 0 | 3 | 4/12 | RSA | P1 P2 P3 6 6 0 |
| 4 | 5/9 | KAMBAROV Ramazan (TKM) | P1 P2 P3 5 4 0 | 4 | 0/0 | KAMBAROV Ramazan (TKM) | P1 P2 P3 0 0 0 | 4 | 0/0 | | |
| 5 | 5/9 | MITROV Dejan (MKD) | P1 P2 P3 5 4 0 | 5 | 3/5 | MITROV Dejan (MKD) | P1 P2 P3 1 4 0 | 5 | 0/0 | MKD | P1 P2 P3 0 0 0 |
| 6 | 5/9 | HANI Elar (EST) | P1 P2 P3 5 4 0 | 6 | 1/0 | HANI Elar (EST) | P1 P2 P3 0 0 0 | 6 | 0/0 | | |
| 7 | 5/9 | GOTISAN Vladimir (MDA) | P1 P2 P3 5 4 0 | 7 | 1/1 | GOTISAN Vladimir (MDA) | P1 P2 P3 1 0 0 | 7 | 8/8 | AZE | P1 P2 P3 2 8 0 |
| 8 | 5/9 | HASANOV Jabrayil (AZE) | P1 P2 P3 5 4 0 | 8 | 3/5 | HASANOV Jabrayil (AZE) | P1 P2 P3 4 1 0 | 8 | 0/0 | | |
| 9 | 5/9 | TUSHISHVILI Otar (GEO) | P1 P2 P3 5 4 0 | 9 | 3/3 | TUSHISHVILI Otar (GEO) | P1 P2 P3 1 2 0 | 9 | 0/0 | GEO | P1 P2 P3 0 0 0 |
| 10 | 5/9 | METCALF B. (USA) | P1 P2 P3 5 4 0 | 10 | 1/2 | METCALF B. (USA) | P1 P2 P3 0 2 0 | 10 | 0/0 | | |
| 11 | 5/9 | BUYANJAV Batzorig (MGL) | P1 P2 P3 5 4 0 | 11 | 3/8 | BUYANJAV Batzorig (MGL) | P1 P2 P3 2 6 0 | 11 | 5/4 | MGL | P1 P2 P3 1 3 0 |
| 12 | 5/9 | COJOCARU Nicolae (ROU) | P1 P2 P3 5 4 0 | 12 | 0/0 | COJOCARU Nicolae (ROU) | P1 P2 P3 0 0 0 | 12 | 0/0 | | |
| 13 | 5/9 | DAUM M. (GER) | P1 P2 P3 5 4 0 | 13 | 3/3 | DAUM M. (GER) | P1 P2 P3 2 1 0 | 13 | 1/1 | GER | P1 P2 P3 1 0 0 |
| 14 | 5/9 | SHAN Chengde (CHN) | P1 P2 P3 5 4 0 | 14 | 0/0 | SHAN Chengde (CHN) | P1 P2 P3 0 0 0 | 14 | 0/0 | | |
| 15 | 5/9 | AKRITIDIS A. (GRE) | P1 P2 P3 5 4 0 | 15 | 0/0 | AKRITIDIS A. (GRE) | P1 P2 P3 0 0 0 | 15 | 3/4 | IND | P1 P2 P3 2 2 0 |
| 16 | 5/9 | SUSHIL Kumar (IND) | P1 P2 P3 5 4 0 | 16 | 3/6 | SUSHIL Kumar (IND) | P1 P2 P3 4 2 0 | 16 | 0/0 | | |
| 17 | 5/9 | HOVHANNISYAN Z. (ARM) | P1 P2 P3 5 4 0 | 17 | 3/4 | HOVHANNISYAN Z. (ARM) | P1 P2 P3 2 2 0 | 17 | 1/2 | ARM | P1 P2 P3 2 0 0 |
| 18 | 5/9 | BATYRAU Albert (BLR) | P1 P2 P3 5 4 0 | 18 | 1/2 | BATYRAU Albert (BLR) | P1 P2 P3 0 2 0 | 18 | 0/0 | | |
| 19 | 5/9 | GARZON CABALLERO J. (CUB) | P1 P2 P3 5 4 0 | 19 | 3/3 | GARZON CABALLERO J. (CUB) | P1 P2 P3 1 2 0 | 19 | 3/6 | CUB | P1 P2 P3 4 2 0 |
| 20 | 5/9 | YONEMITSU T. (JPN) | P1 P2 P3 5 4 0 | 20 | 1/1 | YONEMITSU T. (JPN) | P1 P2 P3 0 1 0 | 20 | 0/0 | | |
| 21 | 5/9 | SAHIN Ramazan (TUR) | P1 P2 P3 5 4 0 | 21 | 1/3 | SAHIN Ramazan (TUR) | P1 P2 P3 3 0 0 | 21 | 0/0 | UKR | P1 P2 P3 0 0 0 |
| 22 | 5/9 | STADNIK Andriy (UKR) | P1 P2 P3 5 4 0 | 22 | 3/11 | STADNIK Andriy (UKR) | P1 P2 P3 6 5 0 | 22 | 0/0 | | |
| 23 | 5/9 | TAGHAVI KERMANI M. (IRI) | P1 P2 P3 5 4 0 | 23 | 3/5 | TAGHAVI KERMANI M. (IRI) | P1 P2 P3 1 4 0 | 23 | 3/6 | IRI | P1 P2 P3 0 6 0 |
| 24 | 5/9 | NAVRUZOV Ikhtiyor (UZB) | P1 P2 P3 5 4 0 | 24 | 1/2 | NAVRUZOV Ikhtiyor (UZB) | P1 P2 P3 0 2 0 | 24 | 0/0 | | |
| 25 | 5/9 | KIM Dai-Sung (KOR) | P1 P2 P3 5 4 0 | 25 | 3/8 | KIM Dai-Sung (KOR) | P1 P2 P3 3 5 0 | 25 | 3/5 | KOR | P1 P2 P3 4 1 0 |
| 26 | 5/9 | KACENAK Jakub (SVK) | P1 P2 P3 5 4 0 | 26 | 0/0 | KACENAK Jakub (SVK) | P1 P2 P3 0 0 0 | 26 | 0/0 | | |
| 27 | 5/9 | TANATAROV Akzhurek (KAZ) | P1 P2 P3 5 4 0 | 27 | 5/8 | TANATAROV Akzhurek (KAZ) | P1 P2 P3 8 0 0 | 27 | 1/1 | KAZ | P1 P2 P3 1 0 0 |
| 28 | 5/9 | MANIBUSAN M. (GUM) | P1 P2 P3 5 4 0 | 28 | 0/0 | MANIBUSAN M. (GUM) | P1 P2 P3 0 0 0 | 28 | 0/0 | | |
| 29 | 5/9 | VERANES GARCIA H. (CAN) | P1 P2 P3 5 4 0 | 29 | 1/1 | VERANES GARCIA H. (CAN) | P1 P2 P3 0 1 0 | 29 | 3/4 | RUS | P1 P2 P3 1 3 0 |
| 30 | 3/4 | GOGAEV Alan (RUS) | P1 P2 P3 2 2 0 | 30 | 3/3 | GOGAEV Alan (RUS) | P1 P2 P3 1 1 1 | 30 | 0/0 | | |
| 31 | 0/0 | BLANCO REINOSO Y. (ECU) | P1 P2 P3 0 0 0 | 31 | 0/0 | | | 31 | 0/0 | | |
| 32 | 1/1 | SHARIPOV GULOM (TKJ) | P1 P2 P3 0 1 0 | 32 | 3/2 | POLIAK Yuri (ISR) | P1 P2 P3 1 1 0 | 32 | 1/1 | ISR | P1 P2 P3 0 1 0 |
| 33 | 3/1 | POLIAK Yuri (ISR) | P1 P2 P3 4 3 0 | 33 | 0/0 | | | 33 | 0/0 | | |
| 34 | 4/14 | ABDOU Omar Ahmed (EGY) | P1 P2 P3 8 3 0 | 34 | 1/1 | ABDOU Omar Ahmed (EGY) | P1 P2 P3 1 0 0 | 34 | 0/0 | | |
| 35 | 0/0 | PAULET S. (NZL) | P1 P2 P3 0 0 0 | 35 | 0/0 | | | 35 | 0/0 | | |



Feuille de compétition / Competition Sheet

Senior World Championships

STYLE : FS 66 kg



WORLD WRESTLING
FEDERATION
CHAMPIONSHIP



Classement

| Cl | Pays | Nom |
|----|------|--------------------------|
| 1 | IND | SUSHIL Kumar |
| 2 | RUS | GOGAEV Alan |
| 3 | AZE | HASANOV Jabrayil |
| 3 | CUB | GARZON CABALLERO Jeandry |
| 5 | MGL | BUYANJAV Batzorig |
| 5 | CAN | VERANES GARCIA Haislan |
| 7 | RSA | BARNES Heinrich |
| 8 | GER | DAUM Martin Sebastian |
| 9 | ISR | POLIAK Yuri |
| 10 | KAZ | TANATAROV Akzhurek |
| 11 | IRI | TAGHAVI KERMANI Mehdi |
| 12 | KOR | KIM Dai-Sung |
| 13 | BUL | REDZHEP Ismail Emin |
| 14 | EGY | ABDOU Omar Ahmed |
| 15 | ARM | HOVHANNISYAN Zhirayr |
| 16 | UKR | STADNIK Andriy |
| 17 | MKD | MITROV Dejan |
| 18 | GEO | TUSHISHVILI Otar |
| 19 | TUR | SAHIN Ramazan |
| 20 | USA | METCALF Brent Harold |

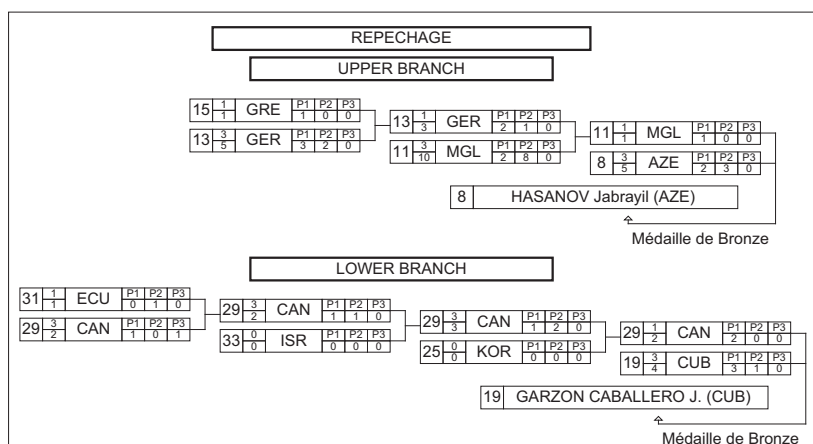



Classement

Senior World Championships



STYLE : FS 66 kg

1 - Or / Gold



SUSHIL Kumar

2 - Argent / Silver



GOGAEV Alan

3 - Bronze



HASANOV Jabrayil



GARZON CABALLERO Jeandry

| Classement | Nom - Name | Pays - Country |
|------------|-----------------------|----------------|
| 1 | SUSHIL Kumar | IND |
| 2 | GOGAEV Alan | RUS |
| 3 | HASANOV Jabrayil | AZE |
| 3 | GARZON CABALLERO J. | CUB |
| 5 | BUYANJAV Batzorig | MGL |
| 5 | VERANES GARCIA H. | CAN |
| 7 | BARNES Heinrich | RSA |
| 8 | DAUM Martin Sebastian | GER |
| 9 | POLIAK Yuri | ISR |
| 10 | TANATAROV Akzhurek | KAZ |
| 11 | TAGHAVI KERMANI Mehdi | IRI |
| 12 | KIM Dai-Sung | KOR |
| 13 | REDZHEP Ismail Emin | BUL |
| 14 | ABDOU Omar Ahmed | EGY |
| 15 | HOVHANNISYAN Zhirayr | ARM |
| 16 | STADNIK Andriy | UKR |
| 17 | MITROV Dejan | MKD |
| 18 | TUSHISHVILI Otar | GEO |
| 19 | SAHIN Ramazan | TUR |
| 20 | METCALF Brent Harold | USA |
| 21 | BATYRAU Albert | BLR |
| 22 | NAVRUZOV Ikhtiyor | UZB |
| 23 | YONEMITSU Tatsuhiro | JPN |
| 24 | GOTISAN Vladimir | MDA |
| 25 | BLANCO REINOSO Yoan | ECU |
| 26 | SHARIPOV GULOM | TJK |
| 27 | AKRITIDIS Anastasios | GRE |
| 28 | HANI Elar | EST |
| 29 | CAMPAGNA Raimondo | ITA |
| 30 | SHAN Chengde | CHN |



Classement

Senior World Championships

STYLE : FS 66 kg



WORLD WRESTLING
CHAMPIONSHIP

| <i>Classement</i> | <i>Nom - Name</i> | <i>Pays - Country</i> |
|-------------------|-------------------------|-----------------------|
| 31 | COJOCARU Nicolae | ROU |
| 31 | KACENAK Jakub | SVK |
| 31 | MANIBUSAN Melchor Vince | GUM |
| 34 | KAMBAROV Ramazan | TKM |
| 35 | PAULET Sergiu Andrei | NZL |



Feuille de compétition / Competition Sheet

Senior World Championships

STYLE : FS 74 kg



WORLD WRESTLING
 INTERNATIONAL FEDERATION
 CHAMPIONSHIP



Classement

| Cl | Pays | Nom |
|----|------|----------------------------|
| 1 | RUS | TSARGUSH Denis |
| 2 | IRI | GOUDARZI Sadegh Saeed |
| 3 | HUN | HATOS Gábor |
| 3 | KAZ | SHAPIYEV Abdulkhakim |
| 5 | POL | BRZOWSKI Krystian |
| 5 | CUB | FUNDORA ZALDIVAR Ivan |
| 7 | BUL | TERZIEV Kiril Stoychev |
| 8 | UKR | SYROTYN Volodymyr |
| 9 | GER | SHYYKA Andriy |
| 10 | MDA | DERMENJI Roman |
| 11 | KOR | LEE Yun-Seok |
| 12 | BLR | MATYL Aliaksandr |
| 13 | GRE | MOTSALIN Olegk |
| 14 | ARM | MARKOSYAN Suren |
| 15 | CAN | GENTRY Matthew Judah |
| 16 | AZE | CHAMSULVARAYEV Chamsulvara |
| 17 | MGL | MYAGMAR Mendsaikhan |
| 18 | IND | YADAV Narsingh Pancham |
| 19 | GBS | MIDANA Augusto |
| 20 | SUI | RIESEN Marco Lukas |

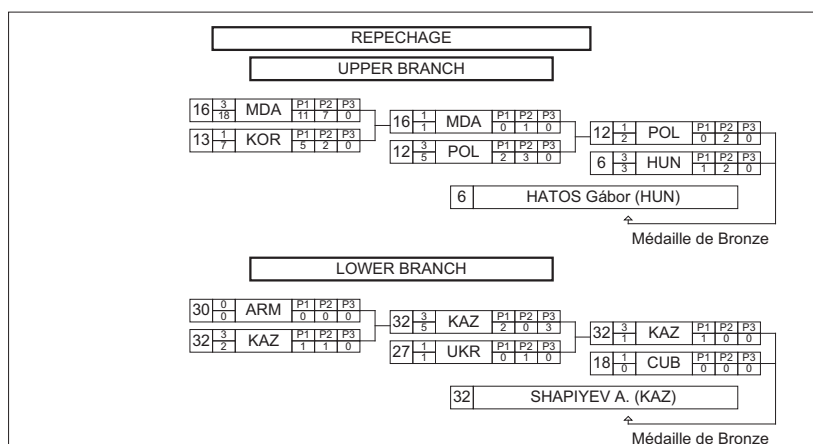



Classement

Senior World Championships

STYLE : FS 74 kg



1 - Or / Gold



TSARGUSH Denis

2 - Argent / Silver



GOUDARZI Sadegh Saeed

3 - Bronze



HATOS Gábor



SHAPIYEV Abdulkhakim

| Classement | Nom - Name | Pays - Country |
|------------|----------------------------|----------------|
| 1 | TSARGUSH Denis | RUS |
| 2 | GOUDARZI S. | IRI |
| 3 | HATOS Gábor | HUN |
| 3 | SHAPIYEV A. | KAZ |
| 5 | BRZOZOWSKI Krystian | POL |
| 5 | FUNDORA ZALDIVAR I. | CUB |
| 7 | TERZIEV Kiril Stoychev | BUL |
| 8 | SYROTYN Volodymyr | UKR |
| 9 | SHYYKA Andriy | GER |
| 10 | DERMENJI Roman | MDA |
| 11 | LEE Yun-Seok | KOR |
| 12 | MATYL Aliaksandr | BLR |
| 13 | MOTSALIN Olegk | GRE |
| 14 | MARKOSYAN Suren | ARM |
| 15 | GENTRY Matthew Judah | CAN |
| 16 | CHAMSULVARAYEV Chamsulvara | AZE |
| 17 | MYAGMAR Mendsaikhan | MGL |
| 18 | YADAV Narsingh Panoram | IND |
| 19 | MIDANA Augusto | GBS |
| 20 | RIESEN Marco Lukas | SUI |
| 21 | SAGIRASHVILI Gela | GEO |
| 22 | BABRNAK Dusan | SVK |
| 23 | BAZARBAEV Abdurauf | UZB |
| 24 | ZHANG Chongyao | CHN |
| 25 | DEMIRCIN Batuhan | TUR |
| 26 | LAMPIS Luca Ezio | FRA |
| 27 | ATOFANI Marius Lucian | ROU |
| 28 | NAGASHIMA Kazuyuki | JPN |
| 29 | PAULSON Travis Eugene | USA |
| 30 | ADDINALL Richard Brian | RSA |



Classement

Senior World Championships

STYLE : FS 74 kg



WORLD WRESTLING
CHAMPIONSHIP

| <i>Classement</i> | <i>Nom - Name</i> | <i>Pays - Country</i> |
|-------------------|----------------------------|-----------------------|
| 31 | CREPAZ Philipp | AUT |
| 32 | UTHURBURU FERNANDEZ Daniel | URU |
| 33 | RAKHMATOR Ali | TJK |
| 33 | ERMAKOVICH Konstantin | AUS |
| 33 | UERESI Katea | SOL |



Feuille de compétition / Competition Sheet

Senior World Championships



WORLD WRESTLING
FEDERATION
CHAMPIONSHIP

STYLE : FS 84 kg

| QUALIFICATION | | | | 1/16 Finale | | | | 1/8 FINALE | | | |
|---------------|----|----|----|--------------------------|----|----|----|------------|----|----|--------------------------|
| | P1 | P2 | P3 | | P1 | P2 | P3 | | P1 | P2 | P3 |
| 1 | 1 | 0 | 0 | BROWN Donald (CAN) | 0 | 0 | 0 | 1 | 0 | 0 | 0 |
| | 1 | 0 | 0 | | 0 | 0 | 0 | | 0 | 0 | 0 |
| 2 | 1 | 0 | 0 | KTSOEV Soslan (RUS) | 0 | 0 | 0 | 2 | 3 | 7 | RUS |
| | 1 | 0 | 0 | | 0 | 0 | 0 | | 1 | 1 | 8 |
| 3 | 1 | 0 | 0 | MAIER Y. (ARG) | 0 | 0 | 0 | 3 | 0 | 0 | |
| | 1 | 0 | 0 | | 0 | 0 | 0 | | 0 | 0 | 0 |
| 4 | 1 | 0 | 0 | BICHINASHVILI D. (GER) | 0 | 0 | 0 | 4 | 3 | 8 | BICHINASHVILI D. (GER) |
| | 1 | 0 | 0 | | 0 | 0 | 0 | | 3 | 5 | 0 |
| 5 | 1 | 0 | 0 | BENTINIDIS E. (GRE) | 0 | 0 | 0 | 5 | 3 | 11 | BENTINIDIS E. (GRE) |
| | 1 | 0 | 0 | | 0 | 0 | 0 | | 7 | 4 | 0 |
| 6 | 1 | 0 | 0 | FASUGBA A. (ITA) | 0 | 0 | 0 | 6 | 0 | 0 | FASUGBA A. (ITA) |
| | 1 | 0 | 0 | | 0 | 0 | 0 | | 0 | 0 | 0 |
| 7 | 1 | 0 | 0 | TEMREZOV Nauruz (AZE) | 0 | 0 | 0 | 7 | 3 | 5 | TEMREZOV Nauruz (AZE) |
| | 1 | 0 | 0 | | 0 | 0 | 0 | | 2 | 3 | 0 |
| 8 | 1 | 0 | 0 | YAVASER Gokhan (TUR) | 0 | 0 | 0 | 8 | 0 | 0 | YAVASER Gokhan (TUR) |
| | 1 | 0 | 0 | | 0 | 0 | 0 | | 0 | 0 | 0 |
| 9 | 1 | 0 | 0 | HILL S. (NZL) | 0 | 0 | 0 | 9 | 0 | 0 | HILL S. (NZL) |
| | 1 | 0 | 0 | | 0 | 0 | 0 | | 0 | 0 | 0 |
| 10 | 1 | 0 | 0 | GANEV M. (BUL) | 0 | 0 | 0 | 10 | 3 | 2 | BUL |
| | 1 | 0 | 0 | | 0 | 0 | 0 | | 0 | 1 | 1 |
| 11 | 1 | 0 | 0 | IANULOV Piotr (MDA) | 0 | 0 | 0 | 11 | 3 | 4 | IANULOV Piotr (MDA) |
| | 1 | 0 | 0 | | 0 | 0 | 0 | | 3 | 1 | 0 |
| 12 | 1 | 0 | 0 | LEE Jae-Sung (KOR) | 0 | 0 | 0 | 12 | 1 | 1 | LEE Jae-Sung (KOR) |
| | 1 | 0 | 0 | | 0 | 0 | 0 | | 0 | 1 | 0 |
| 13 | 1 | 0 | 0 | BOGDANOV Dejan (MKD) | 0 | 0 | 0 | 13 | 0 | 1 | BOGDANOV Dejan (MKD) |
| | 1 | 0 | 0 | | 0 | 0 | 0 | | 1 | 0 | 0 |
| 14 | 1 | 0 | 0 | BALAWENDER M. (POL) | 0 | 0 | 0 | 14 | 5 | 4 | BALAWENDER M. (POL) |
| | 1 | 0 | 0 | | 0 | 0 | 0 | | 4 | 0 | 0 |
| 15 | 1 | 0 | 0 | MATSUMOTO Atsushi (JPN) | 0 | 0 | 0 | 15 | 5 | 12 | MATSUMOTO Atsushi (JPN) |
| | 1 | 0 | 0 | | 0 | 0 | 0 | | 3 | 6 | 3 |
| 16 | 1 | 0 | 0 | MEYER G. (RSA) | 0 | 0 | 0 | 16 | 0 | 6 | MEYER G. (RSA) |
| | 1 | 0 | 0 | | 0 | 0 | 0 | | 5 | 0 | 1 |
| 17 | 1 | 0 | 0 | LALIEV Vadim (ARM) | 0 | 0 | 0 | 17 | 3 | 10 | LALIEV Vadim (ARM) |
| | 1 | 0 | 0 | | 0 | 0 | 0 | | 4 | 6 | 0 |
| 18 | 1 | 0 | 0 | VASSALLO Abraham (MLT) | 0 | 0 | 0 | 18 | 0 | 0 | VASSALLO Abraham (MLT) |
| | 1 | 0 | 0 | | 0 | 0 | 0 | | 0 | 0 | 0 |
| 19 | 1 | 0 | 0 | LASHGARI E. (IRI) | 0 | 0 | 0 | 19 | 1 | 2 | LASHGARI E. (IRI) |
| | 1 | 0 | 0 | | 0 | 0 | 0 | | 1 | 1 | 0 |
| 20 | 1 | 0 | 0 | STEFAN Gheorghita (ROU) | 0 | 0 | 0 | 20 | 3 | 4 | STEFAN Gheorghita (ROU) |
| | 1 | 0 | 0 | | 0 | 0 | 0 | | 2 | 2 | 0 |
| 21 | 1 | 0 | 0 | SOKHIEV Zaurbek (UZB) | 0 | 0 | 0 | 21 | 3 | 4 | SOKHIEV Zaurbek (UZB) |
| | 1 | 0 | 0 | | 0 | 0 | 0 | | 1 | 3 | 0 |
| 22 | 1 | 0 | 0 | DORJVANCHIG T. (MGL) | 0 | 0 | 0 | 22 | 0 | 0 | DORJVANCHIG T. (MGL) |
| | 1 | 0 | 0 | | 0 | 0 | 0 | | 0 | 0 | 0 |
| 23 | 1 | 0 | 0 | SALAS PEREZ R. (CUB) | 0 | 0 | 0 | 23 | 3 | 6 | SALAS PEREZ R. (CUB) |
| | 1 | 0 | 0 | | 0 | 0 | 0 | | 4 | 2 | 0 |
| 24 | 1 | 0 | 0 | HERBERT Jacob John (USA) | 0 | 0 | 0 | 24 | 0 | 0 | HERBERT Jacob John (USA) |
| | 1 | 0 | 0 | | 0 | 0 | 0 | | 0 | 0 | 0 |
| 25 | 1 | 0 | 0 | ESPINAL J. (PUR) | 0 | 0 | 0 | 25 | 1 | 2 | ESPINAL J. (PUR) |
| | 1 | 0 | 0 | | 0 | 0 | 0 | | 0 | 2 | 0 |
| 26 | 1 | 0 | 0 | ALDATOV Ibragim (UKR) | 0 | 0 | 0 | 26 | 3 | 11 | ALDATOV Ibragim (UKR) |
| | 1 | 0 | 0 | | 0 | 0 | 0 | | 3 | 8 | 0 |
| 27 | 1 | 0 | 0 | ROBERTTY MORENO R. (VEN) | 0 | 0 | 0 | 27 | 3 | 8 | ROBERTTY MORENO R. (VEN) |
| | 1 | 0 | 0 | | 0 | 0 | 0 | | 1 | 7 | 0 |
| 28 | 1 | 0 | 0 | ANDONOV LAZAROV B. (ESP) | 0 | 0 | 0 | 28 | 0 | 0 | ANDONOV LAZAROV B. (ESP) |
| | 1 | 0 | 0 | | 0 | 0 | 0 | | 0 | 0 | 0 |
| 29 | 1 | 0 | 0 | MARSAGISHVILI Dato (GEO) | 0 | 0 | 0 | 29 | 4 | 13 | MARSAGISHVILI Dato (GEO) |
| | 1 | 0 | 0 | | 0 | 0 | 0 | | 7 | 6 | 0 |
| 30 | 1 | 0 | 0 | VERÉB István (HUN) | 0 | 0 | 0 | 30 | 0 | 0 | VERÉB István (HUN) |
| | 1 | 0 | 0 | | 0 | 0 | 0 | | 0 | 0 | 0 |
| 31 | 1 | 0 | 0 | ZVIRBULIS Armands (LAT) | 0 | 0 | 0 | 31 | 1 | 1 | ZVIRBULIS Armands (LAT) |
| | 1 | 0 | 0 | | 0 | 0 | 0 | | 1 | 0 | 0 |
| 32 | 1 | 0 | 0 | AMARHAJY mahamedau (BLR) | 0 | 0 | 0 | 32 | 3 | 0 | AMARHAJY mahamedau (BLR) |
| | 1 | 0 | 0 | | 0 | 0 | 0 | | 4 | 0 | 0 |
| 33 | 3 | 0 | 0 | BERDIYEV Kanat (KAZ) | 0 | 2 | 4 | 33 | 3 | 2 | BERDIYEV Kanat (KAZ) |
| | 3 | 0 | 0 | | 0 | 2 | 4 | | 0 | 1 | 1 |



Feuille de compétition / Competition Sheet

Senior World Championships

STYLE : FS 84 kg



Classement

| Cl | Pays | Nom |
|----|------|--------------------------|
| 1 | BUL | GANEV Mihail Petrov |
| 2 | UZB | SOKHIEV Zaurbek |
| 3 | RUS | KTSOEV Soslan |
| 3 | CUB | SALAS PEREZ Reineris |
| 5 | MDA | IANULOV Piotr |
| 5 | UKR | ALDATOV Ibragim |
| 7 | POL | BALAWENDER Maciej Michal |
| 8 | GEO | MARSAGISHVILI Dato |
| 9 | ARM | LALIEV Vadim |
| 10 | AZE | TEMREZOV Nauruz |
| 11 | JPN | MATSUMOTO Atsushi |
| 12 | KAZ | BERDIYEV Kanat |
| 13 | GRE | BENTINIDIS Emzarios |
| 14 | ROU | STEFAN Gheorghita |
| 15 | VEN | ROBERTTY MORENO Ricardo |
| 16 | GER | BICHINASHVILI Davyd |
| 17 | BLR | AMARHAJY mahamedau |
| 18 | IRI | LASHGARI Ehsan Naser |
| 19 | PUR | ESPINAL Jaime Yusept |
| 20 | LAT | ZVIRBULIS Armands |

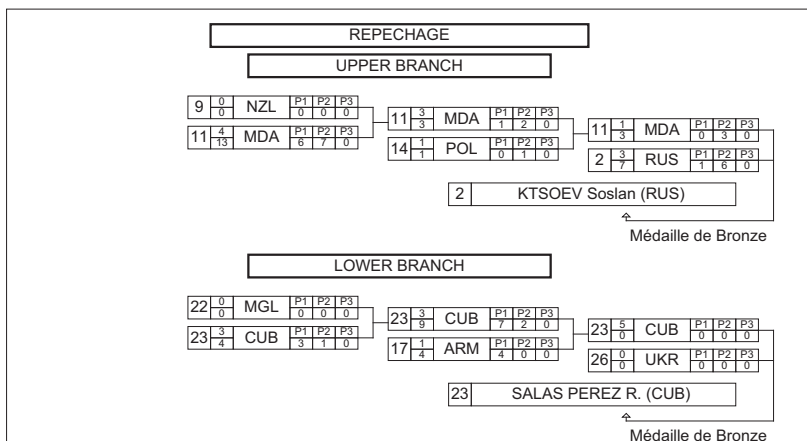



Classement

Senior World Championships

STYLE : FS 84 kg



WORLD WRESTLING
CHAMPIONSHIP

1 - Or / Gold

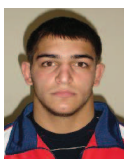

GANEV Mihail Petrov

2 - Argent / Silver



SOKHIEV Zaurbek

3 - Bronze



KTSOEV Soslan



SALAS PEREZ Reineris

| Classement | Nom - Name | Pays - Country |
|------------|---------------------------|----------------|
| 1 | GANEV Mihail Petrov | BUL |
| 2 | SOKHIEV Zaurbek | UZB |
| 3 | KTSOEV Soslan | RUS |
| 3 | SALAS PEREZ R. | CUB |
| 5 | IANULOV Piotr | MDA |
| 5 | ALDATOV Ibragim | UKR |
| 7 | BALAWENDER Maciej Michal | POL |
| 8 | MARSAGISHVILI Dato | GEO |
| 9 | LALIEV Vadim | ARM |
| 10 | TEMREZOV Nauruz | AZE |
| 11 | MATSUMOTO Atsushi | JPN |
| 12 | BERDIYEV Kanat | KAZ |
| 13 | BENTINIDIS Emzarios | GRE |
| 14 | STEFAN Gheorghita | ROU |
| 15 | ROBERTTY MORENO Ricardo | VEN |
| 16 | BICHINASHVILI Davyd | GER |
| 17 | AMARHAJY mahamedau | BLR |
| 18 | LASHGARI Ehsan Naser | IRI |
| 19 | ESPINAL Jaime Yusept | PUR |
| 20 | ZVIRBULIS Armands | LAT |
| 21 | LEE Jae-Sung | KOR |
| 22 | MEYER Gerald Waldemar | RSA |
| 23 | BOGDANOV Dejan | MKD |
| 24 | YAVASER Gokhan | TUR |
| 25 | HERBERT Jacob John | USA |
| 26 | ANDONOV LAZAROV Boris | ESP |
| 26 | MAIER Yuri Alexei Horacio | ARG |
| 26 | BROWN Donald | CAN |
| 26 | DORJVANCHIG Tugjdorj | MGL |
| 30 | VASSALLO Abraham | MLT |



Classement

Senior World Championships

STYLE : FS 84 kg



| <i>Classement</i> | <i>Nom - Name</i> | <i>Pays - Country</i> |
|-------------------|----------------------------|-----------------------|
| 31 | FASUGBA Anthony Olamide Jr | ITA |
| 32 | VERÉB István | HUN |
| 33 | HILL Stephen Matthew | NZL |



Feuille de compétition / Competition Sheet

Senior World Championships



WORLD WRESTLING
FEDERATION
CHAMPIONSHIP

STYLE : FS 96 kg

| QUALIFICATION | | | | 1/16 Finale | | | | 1/8 FINALE | | | |
|---------------|---|---------------------------|-------------------|-------------|----|---------------------------|-------------------|------------|----|-----|-------------------|
| 1 | 0 | RATTIGAN L. (GBR) | P1 P2 P3 0 0 0 | 1 | 0 | RATTIGAN L. (GBR) | P1 P2 P3 0 0 0 | 2 | 3 | TUR | P1 P2 P3 1 4 0 |
| 0 | 0 | | P1 P2 P3 0 0 0 | 0 | 0 | | P1 P2 P3 0 0 0 | 5 | 5 | | |
| 2 | 0 | BALCI Serhat (TUR) | P1 P2 P3 0 0 0 | 2 | 3 | BALCI Serhat (TUR) | P1 P2 P3 1 1 0 | | | | |
| 0 | 0 | | P1 P2 P3 0 0 0 | 2 | 2 | | | | | | |
| 3 | 0 | ISOKAWA Takao (JPN) | P1 P2 P3 0 0 0 | 3 | 3 | ISOKAWA Takao (JPN) | P1 P2 P3 3 1 0 | 3 | 0 | JPN | P1 P2 P3 0 0 0 |
| 0 | 0 | | P1 P2 P3 0 0 0 | 3 | 4 | | | 0 | 0 | | |
| 4 | 0 | ILIEV L. (BUL) | P1 P2 P3 0 0 0 | 4 | 0 | ILIEV L. (BUL) | P1 P2 P3 0 0 0 | | | | |
| 0 | 0 | | P1 P2 P3 0 0 0 | 4 | 0 | | | | | | |
| 5 | 0 | PIERI Andreas (CYP) | P1 P2 P3 0 0 0 | 5 | 0 | PIERI Andreas (CYP) | P1 P2 P3 0 0 0 | 6 | 0 | KOR | P1 P2 P3 0 0 0 |
| 0 | 0 | | P1 P2 P3 0 0 0 | 5 | 0 | | | 0 | 0 | | |
| 6 | 0 | KIM Jae-Gang (KOR) | P1 P2 P3 0 0 0 | 6 | 3 | KIM Jae-Gang (KOR) | P1 P2 P3 3 6 0 | | | | |
| 0 | 0 | | P1 P2 P3 0 0 0 | 6 | 9 | | | | | | |
| 7 | 0 | KURBANOV Kurban (UZB) | P1 P2 P3 0 0 0 | 7 | 1 | KURBANOV Kurban (UZB) | P1 P2 P3 3 0 1 | 8 | 3 | KGZ | P1 P2 P3 4 8 0 |
| 0 | 0 | | P1 P2 P3 0 0 0 | 7 | 4 | | | 10 | 10 | | |
| 8 | 0 | KRUPNYAKOV Alexey (KGZ) | P1 P2 P3 0 0 0 | 8 | 3 | KRUPNYAKOV Alexey (KGZ) | P1 P2 P3 2 2 1 | | | | |
| 0 | 0 | | P1 P2 P3 0 0 0 | 8 | 5 | | | | | | |
| 9 | 0 | WU Yunbilige (CHN) | P1 P2 P3 0 0 0 | 9 | 0 | WU Yunbilige (CHN) | P1 P2 P3 0 0 0 | 10 | 0 | NGR | P1 P2 P3 0 0 0 |
| 0 | 0 | | P1 P2 P3 0 0 0 | 9 | 0 | | | 0 | 0 | | |
| 10 | 0 | BOLTIC Sinivie (NGR) | P1 P2 P3 0 0 0 | 10 | 3 | BOLTIC Sinivie (NGR) | P1 P2 P3 4 1 0 | | | | |
| 0 | 0 | | P1 P2 P3 0 0 0 | 10 | 5 | | | | | | |
| 11 | 0 | GEORGIEV A. (MKD) | P1 P2 P3 0 0 0 | 11 | 0 | GEORGIEV A. (MKD) | P1 P2 P3 0 0 0 | 12 | 3 | BLR | P1 P2 P3 2 1 0 |
| 0 | 0 | | P1 P2 P3 0 0 0 | 11 | 0 | | | 3 | 3 | | |
| 12 | 0 | SHEIKHAU Ruslan (BLR) | P1 P2 P3 0 0 0 | 12 | 3 | SHEIKHAU Ruslan (BLR) | P1 P2 P3 2 4 0 | | | | |
| 0 | 0 | | P1 P2 P3 0 0 0 | 12 | 6 | | | | | | |
| 13 | 0 | PLIEV Khetag (CAN) | P1 P2 P3 0 0 0 | 13 | 3 | PLIEV Khetag (CAN) | P1 P2 P3 4 2 0 | 13 | 1 | CAN | P1 P2 P3 0 1 0 |
| 0 | 0 | | P1 P2 P3 0 0 0 | 13 | 6 | | | 1 | 1 | | |
| 14 | 0 | AZAREVICS Antans (LAT) | P1 P2 P3 0 0 0 | 14 | 1 | AZAREVICS Antans (LAT) | P1 P2 P3 1 0 0 | | | | |
| 0 | 0 | | P1 P2 P3 0 0 0 | 14 | 1 | | | | | | |
| 15 | 0 | GAZYUMOV Khetag (AZE) | P1 P2 P3 0 0 0 | 15 | 3 | GAZYUMOV Khetag (AZE) | P1 P2 P3 7 5 0 | 15 | 3 | AZE | P1 P2 P3 3 6 0 |
| 0 | 0 | | P1 P2 P3 0 0 0 | 15 | 12 | | | 9 | 9 | | |
| 16 | 0 | DIATTA Aristide (SEN) | P1 P2 P3 0 0 0 | 16 | 0 | DIATTA Aristide (SEN) | P1 P2 P3 0 0 0 | | | | |
| 0 | 0 | | P1 P2 P3 0 0 0 | 16 | 0 | | | | | | |
| 17 | 0 | VAN HUYSTEEN E. (RSA) | P1 P2 P3 0 0 0 | 17 | 1 | VAN HUYSTEEN E. (RSA) | P1 P2 P3 1 4 1 | 18 | 1 | SVK | P1 P2 P3 0 2 0 |
| 0 | 0 | | P1 P2 P3 0 0 0 | 17 | 6 | | | 2 | 2 | | |
| 18 | 0 | JALOVIAR Jozef (SVK) | P1 P2 P3 0 0 0 | 18 | 3 | JALOVIAR Jozef (SVK) | P1 P2 P3 1 1 2 | | | | |
| 0 | 0 | | P1 P2 P3 0 0 0 | 18 | 4 | | | | | | |
| 19 | 0 | YENOKYAN Edgar (ARM) | P1 P2 P3 0 0 0 | 19 | 1 | YENOKYAN Edgar (ARM) | P1 P2 P3 1 0 0 | 20 | 3 | RUS | P1 P2 P3 1 4 0 |
| 0 | 0 | | P1 P2 P3 0 0 0 | 19 | 1 | | | 5 | 5 | | |
| 20 | 0 | GATSALOV K. (RUS) | P1 P2 P3 0 0 0 | 20 | 3 | GATSALOV K. (RUS) | P1 P2 P3 1 6 0 | | | | |
| 0 | 0 | | P1 P2 P3 0 0 0 | 20 | 7 | | | | | | |
| 21 | 0 | PAPADOPOULOS I. (GRE) | P1 P2 P3 0 0 0 | 21 | 0 | PAPADOPOULOS I. (GRE) | P1 P2 P3 0 0 0 | 22 | 3 | GEO | P1 P2 P3 1 3 0 |
| 0 | 0 | | P1 P2 P3 0 0 0 | 21 | 0 | | | 4 | 4 | | |
| 22 | 0 | GOGSHELIDZE George (GEO) | P1 P2 P3 0 0 0 | 22 | 3 | GOGSHELIDZE George (GEO) | P1 P2 P3 2 5 0 | | | | |
| 0 | 0 | | P1 P2 P3 0 0 0 | 22 | 7 | | | | | | |
| 23 | 0 | ABATAM Maurice (CHA) | P1 P2 P3 0 0 0 | 23 | 1 | ABATAM Maurice (CHA) | P1 P2 P3 0 0 0 | 24 | 1 | POL | P1 P2 P3 0 1 0 |
| 0 | 0 | | P1 P2 P3 0 0 0 | 23 | 0 | | | 1 | 1 | | |
| 24 | 0 | BARAN Radoslaw (POL) | P1 P2 P3 0 0 0 | 24 | 3 | BARAN Radoslaw (POL) | P1 P2 P3 2 6 0 | | | | |
| 0 | 0 | | P1 P2 P3 0 0 0 | 24 | 8 | | | | | | |
| 25 | 0 | ANAKULOV Farkhod (TJK) | P1 P2 P3 0 0 0 | 25 | 0 | ANAKULOV Farkhod (TJK) | P1 P2 P3 0 0 0 | 26 | 1 | USA | P1 P2 P3 1 2 0 |
| 0 | 0 | | P1 P2 P3 0 0 0 | 25 | 0 | | | 3 | 3 | | |
| 26 | 0 | BERGMAN J. (USA) | P1 P2 P3 0 0 0 | 26 | 5 | BERGMAN J. (USA) | P1 P2 P3 4 3 0 | | | | |
| 0 | 0 | | P1 P2 P3 0 0 0 | 26 | 7 | | | | | | |
| 27 | 0 | SHABANBAY Dautlet (KAZ) | P1 P2 P3 0 0 0 | 27 | 1 | SHABANBAY Dautlet (KAZ) | P1 P2 P3 0 1 0 | 28 | 3 | IRI | P1 P2 P3 2 4 0 |
| 0 | 0 | | P1 P2 P3 0 0 0 | 27 | 1 | | | 6 | 6 | | |
| 28 | 0 | AMIRI A. (IRI) | P1 P2 P3 0 0 0 | 28 | 3 | AMIRI A. (IRI) | P1 P2 P3 1 2 0 | | | | |
| 0 | 0 | | P1 P2 P3 0 0 0 | 28 | 3 | | | | | | |
| 29 | 0 | BATISTA MARTINEZ M. (CUB) | P1 P2 P3 0 0 0 | 29 | 3 | BATISTA MARTINEZ M. (CUB) | P1 P2 P3 2 2 0 | 29 | 3 | CUB | P1 P2 P3 3 2 0 |
| 0 | 0 | | P1 P2 P3 0 0 0 | 29 | 4 | | | 5 | 5 | | |
| 30 | 0 | YADAMSUREN A. (MGL) | P1 P2 P3 0 0 0 | 30 | 0 | YADAMSUREN A. (MGL) | P1 P2 P3 0 0 0 | | | | |
| 0 | 0 | | P1 P2 P3 0 0 0 | 30 | 0 | | | | | | |
| 31 | 0 | CEBAN Nicolai (MDA) | P1 P2 P3 0 0 0 | 31 | 3 | CEBAN Nicolai (MDA) | P1 P2 P3 1 1 0 | 31 | 0 | MDA | P1 P2 P3 0 0 0 |
| 0 | 0 | | P1 P2 P3 0 0 0 | 31 | 2 | | | 0 | 0 | | |
| 32 | 3 | ANDRIITSEV Valerii (UKR) | P1 P2 P3 0 3 5 | 32 | 1 | ANDRIITSEV Valerii (UKR) | P1 P2 P3 0 1 0 | | | | |
| 0 | 0 | | P1 P2 P3 0 0 0 | 32 | 1 | | | | | | |
| 33 | 1 | KESSEL Johannes (GER) | P1 P2 P3 1 2 0 | 33 | 1 | KESSEL Johannes (GER) | P1 P2 P3 0 1 0 | | | | |
| 0 | 0 | | P1 P2 P3 0 0 0 | 33 | 3 | | | | | | |



Feuille de compétition / Competition Sheet

Senior World Championships

STYLE : FS 96 kg



WORLD WRESTLING
FEDERATION
CHAMPIONSHIP



Classement

| Cl | Pays | Nom |
|----|------|---------------------------------|
| 1 | AZE | GAZYUMOV Khetag |
| 2 | RUS | GATSALOV Khadzhimurat |
| 3 | KGZ | KRUPNYAKOV Alexey |
| 3 | GEO | GOGSHELIDZE George |
| 5 | BLR | SHEIKHAU Ruslan |
| 5 | IRI | AMIRI Arfan Moradali |
| 7 | CAN | PLIEV Khetag |
| 8 | CUB | BATISTA MARTINEZ Michel Antonio |
| 9 | TUR | BALCI Serhat |
| 10 | USA | BERGMAN James Daniel |
| 11 | SVK | JALOVIAI Jozef |
| 11 | ARM | YENOKYAN Edgar |
| 13 | POL | BARAN Radoslaw |
| 14 | UKR | ANDRIITSEV Valerii |
| 15 | KOR | KIM Jae-Gang |
| 16 | NGR | BOLTIC Sinivie |
| 17 | JPN | ISOKAWA Takao |
| 18 | MDA | CEBAN Nicolai |
| 19 | RSA | VAN HUYSTSTEEN Etienne |
| 20 | UZB | KURBANOV Kurban |

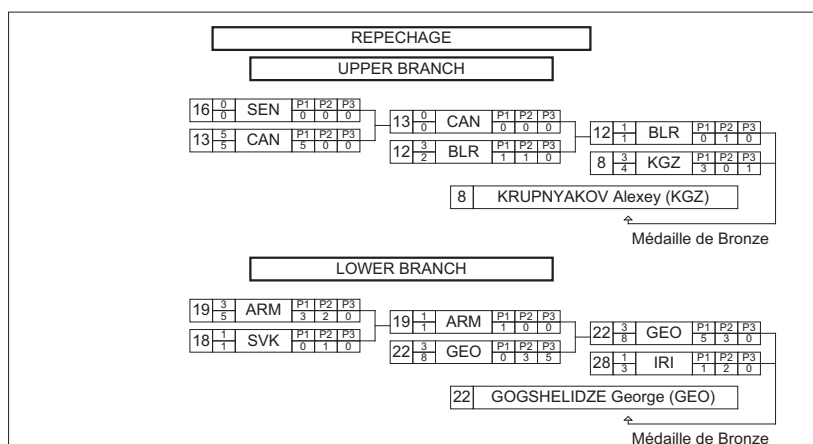



Classement

Senior World Championships

STYLE : FS 96 kg



1 - Or / Gold

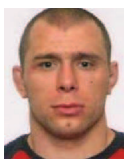

GAZYUMOV Khetag

2 - Argent / Silver



GATSALOV Khadzhimurat

3 - Bronze

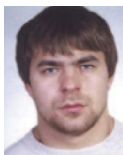

KRUPNYAKOV Alexey



GOGSHELIDZE George

| Classement | Nom - Name | Pays - Country |
|------------|---------------------------------|----------------|
| 1 | GAZYUMOV Khetag | AZE |
| 2 | GATSALOV K. | RUS |
| 3 | KRUPNYAKOV Alexey | KGZ |
| 3 | GOGSHELIDZE George | GEO |
| 5 | SHEIKHAU Ruslan | BLR |
| 5 | AMIRI A. | IRI |
| 7 | PLIEV Khetag | CAN |
| 8 | BATISTA MARTINEZ Michel Antonio | CUB |
| 9 | BALCI Serhat | TUR |
| 10 | BERGMAN James Daniel | USA |
| 11 | JALOVIAR Jozef | SVK |
| 11 | YENOKYAN Edgar | ARM |
| 13 | BARAN Radoslaw | POL |
| 14 | ANDRIITSEV Valerii | UKR |
| 15 | KIM Jae-Gang | KOR |
| 16 | BOLTIC Sinivie | NGR |
| 17 | ISOKAWA Takao | JPN |
| 18 | CEBAN Nicolai | MDA |
| 19 | VAN HUYSSTEEN Etienne | RSA |
| 20 | KURBANOV Kurban | UZB |
| 21 | KESSEL Johannes | GER |
| 22 | SHABANBAY Daulet | KAZ |
| 23 | AZAREVICS Antans | LAT |
| 24 | ABATAM Maurice | CHA |
| 25 | RATTIGAN Leon Gregory | GBR |
| 26 | ILIEV Lyuben Borisov | BUL |
| 26 | YADAMSUREN Altantulga | MGL |
| 28 | WU Yunbilige | CHN |
| 29 | GEORGIEV Aleksandar | MKD |
| 30 | PAPADOPOULOS Ioannis | GRE |
| 30 | ANAKULOV Farkhod | TJK |



Classement

Senior World Championships

STYLE : FS 96 kg



| <i>Classement</i> | <i>Nom - Name</i> | <i>Pays - Country</i> |
|-------------------|-------------------|-----------------------|
| 32 | PIERI Andreas | CYP |
| 33 | DIATTA Aristide | SEN |



Feuille de compétition / Competition Sheet

Senior World Championships



WORLD WRESTLING
FEDERATION
CHAMPIONSHIP

STYLE : FS 120 kg

| QUALIFICATION | | | 1/8 FINALE | | | 1/4 FINALE | | | 1/2 FINALE | | | FINALE | | | | | | | | | | | | | |
|---------------|---------------------------|----|------------|----|-----|------------|----|----|------------|-------------------------|----|--------|----|-----|----|----|----|---|-------------------------|----|----|----|---|---|---|
| 1 | VIVENES URBANEJA L. (VEN) | | 1 | 0 | VEN | P1 | P2 | P3 | 0 | 0 | 0 | 2 | 3 | RUS | P1 | P2 | P3 | 5 | 2 | 0 | | | | | |
| 2 | MAKHOV Bilyal (RUS) | | 2 | 3 | RUS | P1 | P2 | P3 | 4 | 5 | 0 | 2 | 3 | RUS | P1 | P2 | P3 | 3 | 2 | 0 | | | | | |
| 3 | MIHAILOVS Dmitrijs (LAT) | | 3 | 0 | LAT | P1 | P2 | P3 | 0 | 0 | 0 | 4 | 1 | HUN | P1 | P2 | P3 | 3 | 1 | 0 | | | | | |
| 4 | LIGETI Dániel (HUN) | | 4 | 4 | HUN | P1 | P2 | P3 | 6 | 6 | 0 | 2 | 3 | RUS | P1 | P2 | P3 | 1 | 1 | 0 | | | | | |
| 5 | KUMCHEV D. (BUL) | P1 | P2 | P3 | 1 | 2 | 2 | 5 | 0 | BUL | P1 | P2 | P3 | 0 | 0 | 0 | 8 | 1 | IRI | P1 | P2 | P3 | 1 | 0 | 0 |
| 6 | ABOU JAOUDE A. (BRA) | P1 | P2 | P3 | 2 | 0 | 0 | 8 | 3 | IRI | P1 | P2 | P3 | 2 | 7 | 0 | 12 | 1 | GEO | P1 | P2 | P3 | 1 | 0 | 0 |
| 7 | BASIEV Ruslan (ARM) | P1 | P2 | P3 | 0 | 0 | 0 | 10 | 1 | KAZ | P1 | P2 | P3 | 1 | 0 | 0 | 12 | 3 | GEO | P1 | P2 | P3 | 0 | 1 | 2 |
| 8 | MASOUMI VALADI F. (IRI) | P1 | P2 | P3 | 5 | 1 | 0 | 12 | 3 | GEO | P1 | P2 | P3 | 0 | 1 | 3 | 14 | 1 | AZE | P1 | P2 | P3 | 0 | 3 | 0 |
| 9 | SHIMONAKA Takahiro (JPN) | P1 | P2 | P3 | 0 | 0 | 0 | 14 | 3 | AZE | P1 | P2 | P3 | 3 | 4 | 0 | 15 | 0 | MDA | P1 | P2 | P3 | 0 | 0 | 0 |
| 10 | MUTALIMOV Marid (KAZ) | P1 | P2 | P3 | 1 | 4 | 0 | 15 | 0 | MDA | P1 | P2 | P3 | 0 | 0 | 0 | 17 | 3 | UZB | P1 | P2 | P3 | 3 | 3 | 0 |
| 11 | BARTNICKI B. (POL) | P1 | P2 | P3 | 0 | 0 | 0 | 17 | 3 | UZB | P1 | P2 | P3 | 2 | 3 | 0 | 17 | 3 | UZB | P1 | P2 | P3 | 1 | 2 | 1 |
| 12 | BERIANIDZE Levan (GEO) | P1 | P2 | P3 | 1 | 3 | 0 | 20 | 0 | BLR | P1 | P2 | P3 | 0 | 0 | 0 | 24 | 5 | GRE | P1 | P2 | P3 | 4 | 0 | 0 |
| 13 | ONANENA H. (CMR) | P1 | P2 | P3 | 0 | 0 | 0 | 21 | 1 | USA | P1 | P2 | P3 | 0 | 1 | 0 | 24 | 1 | GRE | P1 | P2 | P3 | 0 | 1 | 0 |
| 14 | ISAYEV Ali (AZE) | P1 | P2 | P3 | 2 | 5 | 0 | 21 | 1 | USA | P1 | P2 | P3 | 0 | 1 | 0 | 26 | 3 | CHN | P1 | P2 | P3 | 4 | 0 | 1 |
| 15 | PODSEVALNICOV A. (MDA) | P1 | P2 | P3 | 3 | 0 | 0 | 24 | 3 | GRE | P1 | P2 | P3 | 1 | 0 | 1 | 26 | 0 | CHN | P1 | P2 | P3 | 1 | 0 | 0 |
| 16 | VARNTAN Aparian (CYP) | P1 | P2 | P3 | 2 | 0 | 0 | 26 | 0 | CHN | P1 | P2 | P3 | 1 | 0 | 0 | 27 | 1 | MGL | P1 | P2 | P3 | 0 | 1 | 0 |
| 17 | TAYMAZOV Artur (UZB) | P1 | P2 | P3 | 1 | 1 | 0 | 27 | 1 | MGL | P1 | P2 | P3 | 0 | 1 | 0 | 28 | 0 | CUBA VAZQUEZ Jose (ESP) | P1 | P2 | P3 | 0 | 0 | 0 |
| 18 | TASOIEV Vadym (UKR) | P1 | P2 | P3 | 0 | 0 | 0 | 28 | 0 | CUBA VAZQUEZ Jose (ESP) | P1 | P2 | P3 | 0 | 0 | 0 | | | | | | | | | |
| 19 | CAKIROGLU Fatih (TUR) | P1 | P2 | P3 | 0 | 0 | 0 | | | | | | | | | | | | | | | | | | |
| 20 | SHEMAROV Alexei (BLR) | P1 | P2 | P3 | 1 | 1 | 0 | | | | | | | | | | | | | | | | | | |
| 21 | SIGMAN Les (USA) | P1 | P2 | P3 | 4 | 0 | 0 | | | | | | | | | | | | | | | | | | |
| 22 | LANE N. (NZL) | P1 | P2 | P3 | 0 | 0 | 0 | | | | | | | | | | | | | | | | | | |
| 23 | LAZAREV Aiaal (KGZ) | P1 | P2 | P3 | 0 | 4 | 0 | | | | | | | | | | | | | | | | | | |
| 24 | ARZOUMANIDIS I. (GRE) | P1 | P2 | P3 | 1 | 1 | 1 | | | | | | | | | | | | | | | | | | |
| 25 | BHULLAR Arjan (CAN) | P1 | P2 | P3 | 1 | 0 | 0 | | | | | | | | | | | | | | | | | | |
| 26 | DONG Zhiwei (CHN) | P1 | P2 | P3 | 0 | 2 | 1 | | | | | | | | | | | | | | | | | | |
| 27 | JARGALSAIKHAN C. (MGL) | P1 | P2 | P3 | 2 | 1 | 0 | | | | | | | | | | | | | | | | | | |

2 MAKHOV Bilyal (RUS)

Classement

| Cl | Pays | Nom |
|----|------|---------------------|
| 1 | RUS | MAKHOV Bilyal |
| 2 | UZB | TAYMAZOV Artur |
| 3 | GEO | BERIANIDZE Levan |
| 3 | GRE | ARZOUMANIDIS I. |
| 5 | HUN | LIGETI Dániel |
| 5 | AZE | ISAYEV Ali |
| 7 | IRI | MASOUMI VALADI F. |
| 8 | KAZ | MUTALIMOV Marid |
| 9 | USA | SIGMAN Les |
| 10 | CHN | DONG Zhiwei |
| 11 | BLR | SHEMAROV Alexei |
| 12 | MDA | PODSEVALNICOV A. |
| 13 | MGL | JARGALSAIKHAN C. |
| 14 | BUL | KUMCHEV D. |
| 15 | KGZ | LAZAREV Aiaal |
| 16 | UKR | TASOIEV Vadym |
| 17 | BRA | ABOU JAOUDE A. |
| 18 | CAN | BHULLAR Arjan |
| 19 | VEN | VIVENES URBANEJA L. |
| 20 | CYP | VARNTAN Aparian |
| 21 | TUR | CAKIROGLU Fatih |
| 22 | ESP | CUBA VAZQUEZ Jose |
| 23 | NZL | LANE N. |
| 23 | POL | BARTNICKI B. |
| 25 | JPN | SHIMONAKA Takahiro |
| 26 | ARM | BASIEV Ruslan |
| 27 | CMR | ONANENA H. |
| 28 | LAT | MIHAILOVS Dmitrijs |

REPECHAGE

REPECHAGE FINALISTE 1

| | | | | | | | | | | | | | | | | | |
|---|---|-----|----|----|----|---|---|---|----|---|-----|----|----|----|---|---|---|
| 1 | 1 | VEN | P1 | P2 | P3 | 0 | 1 | 0 | 4 | 1 | HUN | P1 | P2 | P3 | 3 | 0 | 0 |
| 4 | 3 | HUN | P1 | P2 | P3 | 3 | 3 | 0 | 12 | 3 | GEO | P1 | P2 | P3 | 0 | 1 | 4 |

12 BERIANIDZE Levan (GEO)

Mdaille de Bronze

REPECHAGE FINALISTE 2

| | | | | | | | | | | | | | | | | | |
|----|---|-----|----|----|----|---|---|---|----|---|-----|----|----|----|---|---|---|
| 18 | 1 | UKR | P1 | P2 | P3 | 3 | 0 | 0 | 20 | 0 | BLR | P1 | P2 | P3 | 0 | 0 | 0 |
| 20 | 3 | BLR | P1 | P2 | P3 | 1 | 1 | 1 | 14 | 3 | AZE | P1 | P2 | P3 | 1 | 6 | 0 |
| | | | | | | | | | 14 | 0 | AZE | P1 | P2 | P3 | 0 | 0 | 0 |
| | | | | | | | | | 24 | 3 | GRE | P1 | P2 | P3 | 1 | 1 | 0 |

24 ARZOUMANIDIS I. (GRE)

Mdaille de Bronze



Classement

Senior World Championships

STYLE : FS 120 kg



WORLD WRESTLING
FEDERATION
CHAMPIONSHIP

1 - Or / Gold



MAKHOV Bilyal

2 - Argent / Silver



TAYMAZOV Artur

3 - Bronze



BERIANIDZE Levan



ARZOUMANIDIS Ioannis

| Classement | Nom - Name | Pays - Country |
|------------|--------------------------------|----------------|
| 1 | MAKHOV Bilyal | RUS |
| 2 | TAYMAZOV Artur | UZB |
| 3 | BERIANIDZE Levan | GEO |
| 3 | ARZOUMANIDIS I. | GRE |
| 5 | LIGETI Dániel | HUN |
| 5 | ISAYEV Ali | AZE |
| 7 | MASOUMI VALADI Fardin Papou | IRI |
| 8 | MUTALIMOV Marid | KAZ |
| 9 | SIGMAN Les | USA |
| 10 | DONG Zhiwei | CHN |
| 11 | SHEMAROV Alexei | BLR |
| 12 | PODSEVALNICOV Andrei | MDA |
| 13 | JARGALSAIKHAN Chuluunbat | MGL |
| 14 | KUMCHEV Dimitar Angelov | BUL |
| 15 | LAZAREV Aiaal | KGZ |
| 16 | TASOIEV Vadym | UKR |
| 17 | ABOU JAOUDE Antoine Braga | BRA |
| 18 | BHULLAR Arjan | CAN |
| 19 | VIVENES URBANEJA Luis Felipe | VEN |
| 20 | VARNTAN Aparian | CYP |
| 21 | CAKIROGLU Fatih | TUR |
| 22 | CUBA VAZQUEZ Jose | ESP |
| 23 | LANE Nicholas Spence | NZL |
| 23 | BARTNICKI Bartlomiej Wladyslaw | POL |
| 25 | SHIMONAKA Takahiro | JPN |
| 26 | BASIEV Ruslan | ARM |
| 27 | ONANENA Hugues Thiery | CMR |
| 28 | MIHAILOVS Dmitrijs | LAT |

SENIOR WORLD CHAMPIONSHIPS



MOSCOW (RUS)

2010-09-06 - 2010-09-12 2010

Résultats - Results

Lutte Féminine - Female-Wrestling



**Liste des arbitres / Referee list****Senior World Championships**WORLD WRESTLING
CHAMPIONSHIP

| N° | Licence | Pays Country | Nom - Last Name | Prénom - First Name |
|----|---------|-----------------|-----------------|---------------------|
| | 3106 | BUL | KOSTADINOV | Iantcho |
| | 1079 | CUB | MOLINA GONZALEZ | Guillermo Orestes |
| | 2083 | FIN | TOIVOLA | Karri |
| | 3077 | POL | BRUDZINSKI | Grzegorz |
| | 1734 | RUS | TULUPOV | Vitaly |
| | 2551 | SUI | NOBS | Marianne |
| | 2525 | TUN | BOUAZIZ | Kamel |
| | 770 | USA | TUCCI | Rick |
| | 3129 | UZB | MIHAYILOV | Konstantin |
| 1 | 1598 | CAN | MACKAY | Lee Ronald |
| 2 | 3456 | HUN | PÉTERI | László |
| 3 | 3187 | IRI | TALEBI | Bahman |
| 4 | 3520 | TUR | CICIOGLU | Ibrahim |
| 5 | 3364 | CRO | PETANJEK | Davor |
| 6 | 2224 | GRE | PAGONIS | Vassilios |
| 7 | 2424 | SUI | MEIER | Viktor |
| 8 | 3218 | JPN | ASHIDA | Takaharu |
| 9 | 3267 | RUS | NOVAKOVSKIY | Sergey |
| 10 | 3175 | FIN | TALVITIE | Jaakko |
| 11 | 3213 | JPN | SAITO | Osamu |
| 12 | 4356 | ITA | DÓZSA | Edit |
| 13 | 3826 | SUI | PUTALLAZ | Claude-Alain |
| 14 | 3924 | USA | ERRETT | Zach |
| 15 | 3334 | UKR | KOLENKOV | Olexandr |
| 16 | 3349 | KGZ | KULMATOV | Kochkor |
| 17 | 2559 | GRE | HAMAKOS | Georgios |
| 18 | 2250 | FRA | AIT BRAHAM | Robert |
| 19 | 3231 | TPE | JANG | Tsong-Rong |
| 20 | 3524 | EST | AROLD | Peep |
| 21 | 1351 | MGL | BASKHUU | Aduuch |
| 22 | 3291 | CHN | ZHANG | Xia |
| 24 | 2212 | BUL | ANTOV | Petar |
| 25 | 2541 | ROU | LAZAR | Ovidiu |
| 26 | 3417 | TUR | CEKER | Bekir |
| 27 | 3749 | RUS | KRIKOV | Andrei |
| 28 | 2730 | ITA | NULLI GABBIANI | Giampiero |
| 29 | 3994 | KOR | CHIN | Hyung-Kyun |
| 30 | 3052 | IRI | TAHMASABI | Ali Akbar |
| 31 | 2231 | COL | VELEZ | Gustavo de Jesus |

**Liste des arbitres / Referee list****Senior World Championships**WORLD WRESTLING
CHAMPIONSHIP

| N° | Licence | Pays Country | Nom - Last Name | Prénom - First Name |
|-----------|----------------|-------------------------|------------------------|----------------------------|
| 32 | 3788 | GRE | MIGIPI | Anastasia |
| 33 | 4357 | HUN | BACSA | Péter |
| 34 | 2546 | FRA | LE GLEUT | Régine |
| 35 | 3076 | POL | GLAZ | Andrzej |
| 36 | 2686 | USA | CLARK | Tom |
| 37 | 2513 | GEO | MACHAIDZE | Edisher |
| 38 | 2385 | MAR | MOCHAFFAA | Noredine |
| 39 | 2346 | GER | PROBST | Eberhard |
| 40 | 3284 | UZB | GULAMOV | Tokhir |
| 41 | 2818 | CYP | LOUKA | Loukas |
| 42 | 3286 | CHN | PAN | Hongjun |
| 43 | 3709 | CAN | FRENCH | David |

Nombre d'arbitres - Number of Referee

51



Liste des nations / Countries List

Senior World Championships

STYLE FW



WORLD WRESTLING
FEBRUARY 16-21 SEPTEMBER 2008
CHAMPIONSHIP

Pays - Country

| | | |
|--|------------------|-----|
| | ALLEMAGNE | GER |
| | ARGENTINE | ARG |
| | AUTRICHE | AUT |
| | AZERBAIDJAN | AZE |
| | BELARUS | BLR |
| | BRESIL | BRA |
| | BULGARIE | BUL |
| | CAMEROUN | CMR |
| | CANADA | CAN |
| | CHINE | CHN |
| | CHINESE TAIPEI | TPE |
| | COLOMBIE | COL |
| | COREE | KOR |
| | CUBA | CUB |
| | EGYPTE | EGY |
| | EQUATEUR | ECU |
| | ESPAGNE | ESP |
| | ETATS-UNIS | USA |
| | FINLANDE | FIN |
| | FRANCE | FRA |
| | GRANDE BRETAGNE | GBR |
| | GRECE | GRE |
| | GUINEE-BISSAU | GBS |
| | HOLLANDE | NED |
| | HONGRIE | HUN |
| | ILE MAURICE | MRI |
| | INDE | IND |
| | ITALIE | ITA |
| | JAPON | JPN |
| | KAZAKHSTAN | KAZ |
| | KIRGIZSTAN | KGZ |
| | LETTONIE | LAT |
| | MADAGASCAR | MAD |
| | MOLDAVIE | MDA |
| | MONGOLIE | MGL |
| | NIGERIA | NGR |
| | NORVEGE | NOR |
| | NOUVELLE-ZELANDE | NZL |
| | OUZBEKISTAN | UZB |
| | POLOGNE | POL |
| | PORTO RICO | PUR |
| | ROUMANIE | ROU |
| | RUSSIE | RUS |
| | SALVADOR | ESA |
| | SENEGAL | SEN |
| | SUEDE | SWE |
| | SUISSE | SUI |
| | TCHEQUE REP. | CZE |







Liste des nations / Countries List

Senior World Championships

STYLE FW



| | | |
|---|-----------|-----|
|  | TUNISIE | TUN |
|  | TURQUIE | TUR |
|  | UKRAINE | UKR |
|  | VENEZUELA | VEN |

Nombre de nations - Number of Countries

**Nombre d'engagés par nation / Number of Entries By Country****Senior World Championships**

STYLE FW

WORLD WRESTLING
FEDERATION SENIOR WORLD
CHAMPIONSHIP

| Pays - Country | 48 KG | 51 KG | 55 KG | 59 KG | 63 KG | 67 KG | 72 KG | TOTAL |
|-----------------------|--------------|--------------|--------------|--------------|--------------|--------------|--------------|--------------|
| ARG | 1 | | | | | | | 1 |
| AUT | | | | | 1 | | | 1 |
| AZE | 1 | 1 | 1 | 1 | 1 | 1 | 1 | 7 |
| BLR | 1 | 1 | 1 | 1 | 1 | 1 | 1 | 7 |
| BRA | | | | 1 | | | 1 | 2 |
| BUL | | | | 1 | 1 | | 1 | 3 |
| CAN | 1 | 1 | 1 | 1 | 1 | 1 | 1 | 7 |
| CHN | 1 | 1 | 1 | 1 | 1 | 1 | 1 | 7 |
| CMR | | | | | | | 1 | 1 |
| COL | | | | | 1 | | | 1 |
| CUB | | | | | 1 | | | 1 |
| CZE | | | 1 | | | | | 1 |
| ECU | | | 1 | | | | | 1 |
| EGY | | | | | 1 | 1 | | 2 |
| ESA | 1 | | | | | | | 1 |
| ESP | 1 | 1 | 1 | 1 | 1 | | 1 | 6 |
| FIN | | 1 | | | | | | 1 |
| FRA | | 1 | 1 | 1 | 1 | | 1 | 5 |
| GBR | 1 | | | | | | | 1 |
| GBS | | | | 1 | | | | 1 |
| GER | 1 | | | | 1 | 1 | 1 | 4 |
| GRE | 1 | | | | 1 | | | 2 |
| HUN | | | 1 | | 1 | | | 2 |
| IND | 1 | 1 | | 1 | | | | 3 |
| ITA | | | 1 | | 1 | | | 2 |
| JPN | 1 | 1 | 1 | 1 | 1 | 1 | 1 | 7 |
| KAZ | 1 | 1 | 1 | 1 | 1 | 1 | 1 | 7 |
| KGZ | 1 | | | 1 | | 1 | | 3 |
| KOR | 1 | | 1 | | 1 | | 1 | 4 |
| LAT | | | | 1 | | | | 1 |
| MAD | | | | | 1 | | | 1 |
| MDA | | 1 | | 1 | | | | 2 |
| MGL | 1 | 1 | 1 | 1 | 1 | 1 | 1 | 7 |
| MRI | | | | | 1 | | | 1 |

**Nombre d'engagés par nation / Number of Entries By Country****Senior World Championships****STYLE FW**

| Pays - Country | 48 KG | 51 KG | 55 KG | 59 KG | 63 KG | 67 KG | 72 KG | TOTAL |
|-----------------------|--------------|--------------|--------------|--------------|--------------|--------------|--------------|--------------|
| NED | 1 | | | | | | | 1 |
| NGR | | | | 1 | | 1 | | 2 |
| NOR | | | | | | 1 | | 1 |
| NZL | | | 1 | | | | | 1 |
| POL | 1 | 1 | 1 | | 1 | | | 4 |
| PUR | | | | | | 1 | 1 | 2 |
| ROU | 1 | 1 | 1 | 1 | | | 1 | 5 |
| RUS | 1 | 1 | 1 | 1 | 1 | 1 | 1 | 7 |
| SEN | | 1 | | | | | | 1 |
| SUI | | 1 | | | | | | 1 |
| SWE | | 1 | | 1 | 1 | | 1 | 4 |
| TPE | | | | | 1 | | | 1 |
| TUN | 1 | | 1 | | | | | 2 |
| TUR | 1 | | 1 | | | 1 | | 3 |
| UKR | 1 | 1 | 1 | 1 | 1 | 1 | 1 | 7 |
| USA | 1 | 1 | 1 | 1 | 1 | 1 | 1 | 7 |
| UZB | | | 1 | | 1 | | | 2 |
| VEN | 1 | | | | | | | 1 |
| TOTAL | 25 | 20 | 23 | 22 | 28 | 17 | 20 | 155 |

Nombre de nations - Number of Countries **52**



Liste des Engagés par pays / Entry-List By Country

Senior World Championships

STYLE FW



ARGENTINA (ARG)

Chef de délégation / Team Leader : IGLESIAS, Daniel Alfredo
Entraîneur / Coach : BROSCHINI, Javier
Lutteuse(s) / Wrestler(s) :
48 kg BERMUDEZ, Patricia Alejandra

AUSTRIA (AUT)

Chef de délégation / Team Leader : OSTERMANN, Heinz
Entraîneur / Coach : HARTMANN, Bruno
Médecin / Medical Staff : AICHNER, Alexander
Lutteuse(s) / Wrestler(s) :
63 kg MAIERHOFER, Stephanie

AZERBAIJAN (AZE)

Chef de délégation / Team Leader : RZAYEV, Yashar
EYVAZOV, Tofiq
Entraîneur / Coach : KURBANOV, Kurban
FARMANOV, Arif
Médecin / Medical Staff : ZEYNALOV, Samir
ALIYEVA, Asmar
ALIYEV, Rauf
Kiné / Medical Staff : ISMAYILOV, Seymur
CHERNOVA, Yana
ALIYEV, Khanoglan
Lutteuse(s) / Wrestler(s) :
48 kg BAGOMEDOVA, Patimat
51 kg DOROGAN, Anzhela
55 kg RATKEVICH, Yuliya
59 kg AHMADLI, Sona
63 kg ZUTOVA, Guzel
67 kg SEMENTSOVA, Nadya
72 kg GURBANHAJIYEVA, Zumrud

BELARUS (BLR)

Chef de délégation / Team Leader : TSITOU, Ivan
MAJYDAU, Kamandar
Entraîneur / Coach : KLIUCHNIK, S.
RAIKHLIN, A.



Liste des Engagés par pays / Entry-List By Country

Senior World Championships

STYLE FW



| | |
|------------------------------------|---|
| | SMAL, S. |
| Médecin / Medical Staff : | ZHUKOUSKI, A. SVADKOUSKAYA, K. YAKAULEU, Aliaksandr |
| Kiné / Medical Staff : | HASPADARYK, A. MIKHAILOUSKI, Aliaksandr |
| Lutteuse(s) / Wrestler(s) : | |
| 48 kg | KALADZINSKAYA, Vanesa |
| 51 kg | IVANOVA YAHORAVA, Maryia |
| 55 kg | SIDAKOVA, Zalina |
| 59 kg | FILIPAVA, Alena |
| 63 kg | HUCHOK, Anastasiya |
| 67 kg | KHILKO, Olga |
| 72 kg | MARZALIUK, Vasilisa |

BRAZIL (BRA)

| | |
|------------------------------------|--------------------------|
| Lutteuse(s) / Wrestler(s) : | |
| 59 kg | SOUZA DA SILVA, Joice |
| 72 kg | DA SILVA FERREIRA, Aline |

BULGARIA (BUL)

| | |
|---|---------------------------------------|
| Chef de délégation / Team Leader : | JORDANOV, Valentin |
| Entraîneur / Coach : | CHTEREV, Simeon ANGELOV, Valentin |
| Médecin / Medical Staff : | STRUGAROV, Stefan DIMITROV, Stoyan |
| Kiné / Medical Staff : | BAYAZIT, Mahmud STANCHEV, Stancho |
| Lutteuse(s) / Wrestler(s) : | |
| 59 kg | YUSEIN, Taybe Mustafa |
| 63 kg | VASEVA, Elina Lyubchova |
| 72 kg | HRISTOVA, Stanka Zlateva |

CAMEROON (CMR)

| | |
|------------------------------------|--------------------|
| Lutteuse(s) / Wrestler(s) : | |
| 72 kg | ALI, Annabel Laure |



Liste des Engagés par pays / Entry-List By Country

Senior World Championships

STYLE FW



CANADA (CAN)

| | |
|---|---|
| Chef de délégation / Team Leader : | STEFOPOULOS, Chris MEDWIDSKY, Tamara |
| Entraîneur / Coach : | HINDS, Todd VIERLING, Leigh ZILBERMAN, Victor |
| Médecin / Medical Staff : | NICHOLLS, Michael BUDWAL, Surinder |
| Kiné / Medical Staff : | SISSAOURI, Guivi TKACH, Rick |
| Lutteuse(s) / Wrestler(s) : | |
| 48 kg | HUYNH, Carol |
| 51 kg | MACDONALD BONDY, Jessica |
| 55 kg | GALLAYS, Jillian Alice |
| 59 kg | VERBEEK, Tonya Lynn |
| 63 kg | BOUCHARD, Justine Angelle |
| 67 kg | DUGRENIER, Martine |
| 72 kg | AKUFFO, Ohenewa |

CHINA (CHN)

| | |
|---|--|
| Chef de délégation / Team Leader : | LIU, Zhenduo XUE, Lian DONG, Shenghui |
| Entraîneur / Coach : | ZHANG, Haojie XU, Kuiyuan XIU, Zhentao |
| Médecin / Medical Staff : | YANG, Chao |
| Kiné / Medical Staff : | ZHAO, Fan |
| Lutteuse(s) / Wrestler(s) : | |
| 48 kg | ZHAO, Shasha |
| 51 kg | LI, Hui |
| 55 kg | YANG, Senlian |
| 59 kg | ZHANG, Lan |
| 63 kg | CHEN, Meng |
| 67 kg | CHEN, Ying |
| 72 kg | LI, Dan |

COLOMBIA (COL)



Liste des Engagés par pays / Entry-List By Country

Senior World Championships

STYLE FW



Lutteuse(s) / Wrestler(s) :

63 kg

ROA VELANDIA, Sandra Viviana

CUBA (CUB)

Chef de délégation / Team Leader :

PEREZ TELLEZ, Eduardo

Entraîneur / Coach :

ALFONSO PEREZ, Rodolfo Berto

Médecin / Medical Staff :

MONTESINOS FLORES, Francisco

Lutteuse(s) / Wrestler(s) :

63 kg

VIDIAUX LOPEZ, Katerina

CZECH REPUBLIC (CZE)

Chef de délégation / Team Leader :

VARGA, Ervin

Entraîneur / Coach :

DURCAK, Jindrich

Lutteuse(s) / Wrestler(s) :

55 kg

MARTINAKOVA, Lenka

ECUADOR (ECU)

Lutteuse(s) / Wrestler(s) :

55 kg

ANTES CASTILLO, Lissette Alexandra

EGYPT (EGY)

Lutteuse(s) / Wrestler(s) :

63 kg

ANTAR YASSIN, Nadia Ahmed

67 kg

MOUSTAFA YOUSSEF KHOURSHID, Enas

EL SALVADOR (ESA)

Chef de délégation / Team Leader :

HERNANDEZ ISUSSI, Jorge

Lutteuse(s) / Wrestler(s) :

48 kg

MEDRANO CUELLAR, Ingrid Xiomara

FINLAND (FIN)

Chef de délégation / Team Leader :

RAUHALA, Jukka

Entraîneur / Coach :

RASKA, Ahto

Médecin / Medical Staff :

LEHTO, Mika



Liste des Engagés par pays / Entry-List By Country

Senior World Championships



STYLE FW

Kiné / Medical Staff : NIEMI, Pentti

Lutteuse(s) / Wrestler(s) :

51 kg YLINEN, Tiina Paula

FRANCE (FRA)

Chef de délégation / Team Leader : LASSUYE, François

Entraîneur / Coach : SANTORO, Gérard
AKA AKASSE, Vincent

Médecin / Medical Staff : ROUGEE, Philippe
VITALI, Eric

Kiné / Medical Staff : ROUGEE, Guillaume
BREARD, Jean
GANGLOFF, Philippe

Lutteuse(s) / Wrestler(s) :

51 kg BOUBRYEMM, Vanessa Zohra

55 kg GOMIS, Anna

59 kg SELLOUM FATAH, Meryem

63 kg PRIETO BOKHASHVILI, Audrey Laurence

72 kg BENTORKI, Shéhérazade

GERMANY (GER)

Chef de délégation / Team Leader : SCHMENGLER, Detlef

Entraîneur / Coach : HELMDACH, Jörg
HARTMUT, Reich
SELIMOGLU, Behcet

Médecin / Medical Staff : GSTÖTTNER, Hans
KOLTZ, Christian

Kiné / Medical Staff : MARNETTE, Heinz
KRASS, Wrner
FRANZ, Axel

Lutteuse(s) / Wrestler(s) :

48 kg SCHELLIN, Jaqueline Saskia

63 kg ENGLISH HEES, Yvonne Michaela

67 kg SELMAIER, Maria

72 kg MÜLLER, Maria Erika

GREAT BRITAIN (GBR)

Chef de délégation / Team Leader : MORLEY, Malcolm



Liste des Engagés par pays / Entry-List By Country

Senior World Championships



STYLE FW

Entraîneur / Coach : KORNIIEV, Mykola

Lutteuse(s) / Wrestler(s) :

48 kg STADNIK, Yana

GREECE (GRE)

Chef de délégation / Team Leader : GALAKTOPOULOS, Petros

Entraîneur / Coach : PSOMAS, Dimitros
APOSTOLOU, Nikos

Lutteuse(s) / Wrestler(s) :

48 kg PSATHA, Fani

63 kg PAPAVASILEIOU, Agoro

GUINEA-BISSAU (GBS)

Lutteuse(s) / Wrestler(s) :

59 kg FRANCISCO MENDONCA, Jacira

HUNGARY (HUN)

Chef de délégation / Team Leader : MAROTHY, Istvan

Entraîneur / Coach : VATAI, Laszlo
WÖLLER, Akos

Médecin / Medical Staff : BAKANEK, Gyorgy

Kiné / Medical Staff : HADI, Gegerly

Lutteuse(s) / Wrestler(s) :

55 kg SZABÓ, Emese

63 kg SASTIN, Marianna

INDIA (IND)

Entraîneur / Coach : DOBORJGINIDZE, Roin

MOHINDER, Singh

Kiné / Medical Staff : PERIVINKAL, Kaur

RAHUL, Shamra

GURPREET, Singh

Lutteuse(s) / Wrestler(s) :

48 kg DEVI, Nirmala

51 kg BABITA, Kumari

59 kg TOMAR, Alka



Liste des Engagés par pays / Entry-List By Country

Senior World Championships

STYLE FW



ITALY (ITA)

| | |
|---|---------------------|
| Chef de délégation / Team Leader : | ALBANESE, Aldo |
| Entraîneur / Coach : | SCHILLACI, Giovanni |
| Kiné / Medical Staff : | PILOTTI, Pietro |
| Lutteuse(s) / Wrestler(s) : | |
| 55 kg | MINGUZZI, Valentina |
| 63 kg | CORBANI, Simona |

JAPAN (JPN)

| | |
|---|--|
| Chef de délégation / Team Leader : | MARUYAMA, Hideji HASE, Hiroshi |
| Entraîneur / Coach : | SAKAE, Kazuhito KINASE, Shigeo FUJIKAWA, Kenji YOSHIDA, Eikatsu |
| Médecin / Medical Staff : | NAKAJIMA, Kohei KOMATSU, Yutaka |
| Kiné / Medical Staff : | TAKEUCHI, Tsuyoshi KAWASAKI, Atsushi |
| Lutteuse(s) / Wrestler(s) : | |
| 48 kg | SAKAMOTO, Hitomi |
| 51 kg | HORIUCHI, Yu |
| 55 kg | YOSHIDA, Saori |
| 59 kg | SHODA, Ayako |
| 63 kg | ICHO, Kaori |
| 67 kg | SHINKAI, Mami |
| 72 kg | HAMAGUCHI, Kyoko |

KAZAKHSTAN (KAZ)

| | |
|------------------------------------|-----------------------|
| Lutteuse(s) / Wrestler(s) : | |
| 48 kg | ABUTALIPOVA, Eleonora |
| 51 kg | BAKATYUK, Tatyana |
| 55 kg | ABDILDINA, Aiyim |
| 59 kg | KALININA, Olga |
| 63 kg | ZAKHAROVA, Tatyana |
| 67 kg | SHALYGINA, Elena |
| 72 kg | ZHANIBEKOVA, Olga |



Liste des Engagés par pays / Entry-List By Country

Senior World Championships

STYLE FW



KYRGYZSTAN (KGZ)

Chef de délégation / Team Leader : TURGANBAEV, Melis

Médecin / Medical Staff : ALISHEVA, Baktygul

Kiné / Medical Staff : BATYRBEBKOV, A.

Lutteuse(s) / Wrestler(s) :

48 kg NURMATOVA, Mikhrniso

59 kg KIIAZOVIA, Nestan

67 kg ANARBEKOVA, Elgiza

LATVIA (LAT)

Entraîneur / Coach : KURSITIS, Sergejs

Lutteuse(s) / Wrestler(s) :

59 kg SKUJINA, Laura

MADAGASCAR (MAD)

Lutteuse(s) / Wrestler(s) :

63 kg RAFALIHARISOLO, Maminirina Judicaël

MAURITIUS (MRI)

Lutteuse(s) / Wrestler(s) :

63 kg MILAZAR, Marie Anne-Joyce

MOLDOVA (MDA)

Chef de délégation / Team Leader : CUCUL, Mihail

CORECENCOV, Victor

PEICOV, Victor

Entraîneur / Coach : PETRU, Marta

Médecin / Medical Staff : DERIVOLKOV, Alexandr

Kiné / Medical Staff : CEREDNIK, Iurii

Lutteuse(s) / Wrestler(s) :

51 kg BUDU, Natalia

59 kg CRISTEA, Ludmila

MONGOLIA (MGL)

Chef de délégation / Team Leader : LKHAGVA, Chinbat



Liste des Engagés par pays / Entry-List By Country

Senior World Championships



STYLE FW

Entraîneur / Coach : TUMENDEMBEREL, Sukhbaatar

Médecin / Medical Staff : CHULUUN, Nasanbat

Kiné / Medical Staff : DAVAAJAV, Batnyam

Lutteuse(s) / Wrestler(s) :

| | |
|-------|--------------------------|
| 48 kg | TSOGTBAZAR, Enkhjargal |
| 51 kg | DAVAASUKH, Otgontsetseg |
| 55 kg | SUNDEV, Byambatseren |
| 59 kg | SORONZONBOLD, Battsetseg |
| 63 kg | OCHIRBAT, Nasanburmaa |
| 67 kg | BADRATKH, Odonchimej |
| 72 kg | OCHIRBAT, Burmaa |

NETHERLANDS (NED)

Chef de délégation / Team Leader : HEINRICHS, Jan-Willem

Entraîneur / Coach : KRAUTH, Michael

Lutteuse(s) / Wrestler(s) :

| | |
|-------|---------------------------|
| 48 kg | BLASZKA, Jessica Cornelia |
|-------|---------------------------|

NEW ZEALAND (NZL)

Entraîneur / Coach : HAWKINS, Graeme

Lutteuse(s) / Wrestler(s) :

| | |
|-------|------------------|
| 55 kg | LAW, Sian Eileen |
|-------|------------------|

NIGERIA (NGR)

Chef de délégation / Team Leader : EDEZE, Austin

Entraîneur / Coach : ENEKPEDEKUMOR, Ukpuru

Lutteuse(s) / Wrestler(s) :

| | |
|-------|---------------------|
| 59 kg | OBORUDUDU, Blessing |
| 67 kg | IHEANACHO, Ifeoma |

NORWAY (NOR)

Chef de délégation / Team Leader : MOLNES, Ole-Willy

Lutteuse(s) / Wrestler(s) :

| | |
|-------|------------------------|
| 67 kg | ERLANDSEN, Maja Gunvor |
|-------|------------------------|



Liste des Engagés par pays / Entry-List By Country

Senior World Championships

STYLE FW



POLAND (POL)

Lutteuse(s) / Wrestler(s) :

| | |
|-------|--------------------------|
| 48 kg | MATKOWSKA, Iwona Nina |
| 51 kg | ZASINA, Roksana Marta |
| 55 kg | BILENSKA, Sylwia Barbara |
| 63 kg | MICHALIK, Monika Ewa |

PUERTO RICO (PUR)

Chef de délégation / Team Leader : GARCIA, Manuel

Entraîneur / Coach : BAEZ, Felix

Lutteuse(s) / Wrestler(s) :

| | |
|-------|-------------------------|
| 67 kg | MORALES GARCIA, Yanira |
| 72 kg | RIVERA SUAREZ, Dayanara |

ROMANIA (ROU)

Entraîneur / Coach : CORNEA, Cornel

SUTEU, Aurel

IONITA, Daniel

Médecin / Medical Staff : PLOESTEANU, Nicolae

Lutteuse(s) / Wrestler(s) :

| | |
|-------|-----------------------------|
| 48 kg | CROITORU, Cristina Raluca |
| 51 kg | DOBRE, Estera |
| 55 kg | PAVAL, Ana Maria |
| 59 kg | PAIC, Georgiana Narcisa |
| 72 kg | IANCOLOVICI, Roxana Camelia |

RUSSIA (RUS)

Lutteuse(s) / Wrestler(s) :

| | |
|-------|--------------------|
| 48 kg | OORZHAK, Lorisa |
| 51 kg | RAKHMANOVA, Zamira |
| 55 kg | GUROVA, Maria |
| 59 kg | VIUNOVA, Ekaterina |
| 63 kg | VOLOSOVA, Lubov |
| 67 kg | KARTASHOVA, Alena |
| 72 kg | BUKINA, Ekaterina |



Liste des Engagés par pays / Entry-List By Country

Senior World Championships

STYLE FW



SENEGAL (SEN)

Entraîneur / Coach : AYAOKDO KODEI, Victor

Lutteuse(s) / Wrestler(s) :

51 kg SAMBOU, Isabelle

SOUTH KOREA (KOR)

Chef de délégation / Team Leader : KIM, Hae-Jin

Entraîneur / Coach : HWANG, Young-Tae
OH, Bae-Sub

Lutteuse(s) / Wrestler(s) :

48 kg KIM, Hyung-Joo

55 kg UM, Ji-Eun

63 kg PARK, Sang-Eun

72 kg KANG, Han-Bit

SPAIN (ESP)

Chef de délégation / Team Leader : JAVIER IGLESIAS, Francisco

Entraîneur / Coach : BARCIA, Francisco
CRESPO, Luis

Lutteuse(s) / Wrestler(s) :

48 kg SANCHEZ PARRA, Sara Maria

51 kg SERRANO BARCELO, Maria del Mar

55 kg MONTERO PEREZ, Minerva

59 kg FAJARDO PRIETO, Aurora

63 kg MENDEZ MAYO, Maria Teresa

72 kg UNDA GONZALEZ, Maider

SWEDEN (SWE)

Chef de délégation / Team Leader : MALMKVIST, Lars

BESARATI, Faribolz

Entraîneur / Coach : MAGNUSSON, Patrik

Kiné / Medical Staff : GANNBY, Ingmar

Lutteuse(s) / Wrestler(s) :

51 kg MATTSSON, Sofia Magdalena

59 kg MATTSSON, Malin Johanna

63 kg JOHANSSON, Hanna Katarina

72 kg FRANSSON, Anna Jenny



Liste des Engagés par pays / Entry-List By Country

Senior World Championships

STYLE FW



SWITZERLAND (SUI)

Entraîneur / Coach : FEYER, Christoph

Lutteuse(s) / Wrestler(s) :

51 kg TOKAR, Nadine Simone

TAIPEI CHINESE (TPE)

Entraîneur / Coach : BYAMBAJAV, Battulga

Lutteuse(s) / Wrestler(s) :

63 kg HOU, Min-Wen

TUNISIA (TUN)

Chef de délégation / Team Leader : KHEDHRI, Ahmed

Entraîneur / Coach : SHEPELYEV, Grygoriy

Lutteuse(s) / Wrestler(s) :

48 kg MEZIEN, Maroi

55 kg AMRI, Marwa

TURKEY (TUR)

Chef de délégation / Team Leader : YILDIZ, Ercan

CAKIR, Mustafa

GENC, Mehmet

Entraîneur / Coach : KARA, Habil

NIZAMOGLU, Ismail

Médecin / Medical Staff : GUNES, Elif

SAVRANBASI, Ramazan

Kiné / Medical Staff : AKSAKAL, Suat

CELIK, Ahmet

Lutteuse(s) / Wrestler(s) :

48 kg SEZER, Sumeyya

55 kg ATAKOL, Dilek

67 kg ORSKAYA, Burcu

UKRAINE (UKR)

Chef de délégation / Team Leader : NOSADCHYY, Eduard

KOMARNYTSKA, Tetiana

Entraîneur / Coach : YEVO NOV, Volodymyr



Liste des Engagés par pays / Entry-List By Country

Senior World Championships



STYLE FW

Médecin / Medical Staff :

PISTUN, Andriy
BARNA, Igor
KURINNAYA, Iryna
MOSKALENKO, Oleksandr

Kiné / Medical Staff :

SHVANGYRADZE, Merab
GULKHARIEV, Igor
PARNAK, Andriy
NAZARENKO, Yuriy

Lutteuse(s) / Wrestler(s) :

| | |
|-------|-----------------------|
| 48 kg | DARANUTSA, Khrystyna |
| 51 kg | KOHUT, Oleksandra |
| 55 kg | KHARIV, Iryna |
| 59 kg | SYNYSHYN, Nataliya |
| 63 kg | KVYATKOVSKA, Maryana |
| 67 kg | CHERKASOVA, Alla |
| 72 kg | BURMISTROVA, Kateryna |

UNITED STATES (USA)

Lutteuse(s) / Wrestler(s) :

| | |
|-------|--------------------------|
| 48 kg | LAMPE, Alyssa Rae |
| 51 kg | MEDINA, Jessica Kristina |
| 55 kg | SUAREZ, Tatiana Yadira |
| 59 kg | CAMPBELL, Kelsey Rene |
| 63 kg | PIROZHKOVA, Elena |
| 67 kg | DAVIS, Kristie |
| 72 kg | LEE, Stephany Keala |

UZBEKISTAN (UZB)

Chef de délégation / Team Leader :

ABDUVALIYEV, Salim
TURSUNOV, Botir

Entraîneur / Coach :

IBRAGIMOV, Anatoliy

Médecin / Medical Staff :

ABAEVA, Elena

Kiné / Medical Staff :

BIKTYAKOV, Ravil

Lutteuse(s) / Wrestler(s) :

| | |
|-------|-------------------|
| 55 kg | KAZARYAN, Tamara |
| 63 kg | MIRZAYEVA, Gavhar |

VENEZUELA (VEN)



Liste des Engagés par pays / Entry-List By Country

Senior World Championships

STYLE FW



Lutteuse(s) / Wrestler(s) :

48 kg

CARIPA CASTILLO, Mayelis Yesenia



Feuille de compétition / Competition Sheet

Senior World Championships



WORLD WRESTLING
FEDERATION
CHAMPIONSHIP

STYLE : FW 48 kg

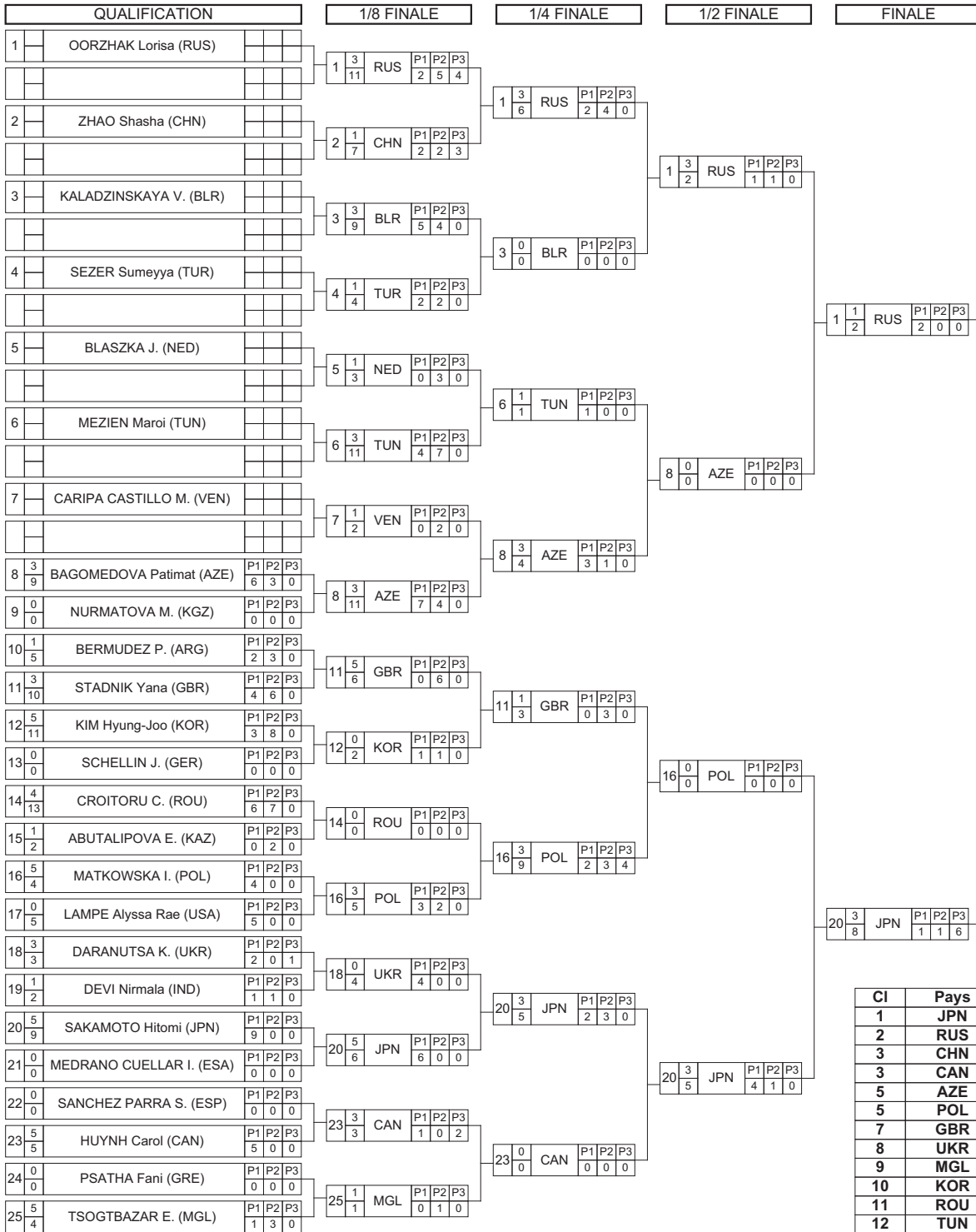

20 SAKAMOTO Hitomi (JPN)

Classement

| Cl | Pays | Nom |
|----|------|---------------------|
| 1 | JPN | SAKAMOTO Hitomi |
| 2 | RUS | OORZHAK Lorisa |
| 3 | CHN | ZHAO Shasha |
| 3 | CAN | HUYNH Carol |
| 5 | AZE | BAGOMEDOVA Patimat |
| 5 | POL | MATKOWSKA I. |
| 7 | GBR | STADNIK Yana |
| 8 | UKR | DARANUTSA Khrystyna |
| 9 | MGL | TSOGTBAZAR E. |
| 10 | KOR | KIM Hyung-Joo |
| 11 | ROU | CROITORU C. |
| 12 | TUN | MEZIEN Maroi |
| 13 | BLR | KALADZINSKAYA V. |
| 14 | ARG | BERMUDEZ P. |
| 15 | TUR | SEZER Sumeyya |
| 16 | NED | BLASZKA J. |
| 17 | IND | DEVI Nirmala |
| 18 | VEN | CARIPA CASTILLO M. |
| 19 | KAZ | ABUTALIPOVA E. |
| 20 | USA | LAMPE Alyssa Rae |
| 21 | ESA | MEDRANO CUELLAR I. |
| 22 | GRE | PSATHA Fani |
| 23 | ESP | SANCHEZ PARRA S. |
| 24 | KGZ | NURMATOVA Mikhrniso |
| 25 | GER | SCHELLIN J. |

REPECHAGE

REPECHAGE FINALISTE 1

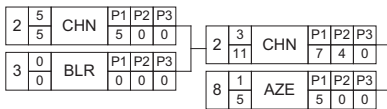

2 ZHAO Shasha (CHN)

Mdaille de Bronze

REPECHAGE FINALISTE 2

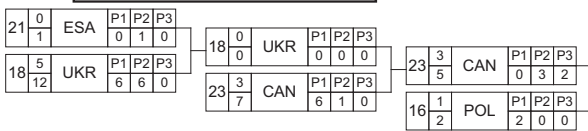

23 HUYNH Carol (CAN)

Mdaille de Bronze



Classement

Senior World Championships

STYLE : FW 48 kg



WORLD WRESTLING
FEBRUARY 16-22, 2017
CHAMPIONSHIP

1 - Or / Gold



SAKAMOTO Hitomi

2 - Argent / Silver



OORZHAK Lorisa

3 - Bronze



ZHAO Shasha



HUYNH Carol

| Classement | Nom - Name | Pays - Country |
|------------|---------------------------------|----------------|
| 1 | SAKAMOTO Hitomi | JPN |
| 2 | OORZHAK Lorisa | RUS |
| 3 | ZHAO Shasha | CHN |
| 3 | HUYNH Carol | CAN |
| 5 | BAGOMEDOVA Patimat | AZE |
| 5 | MATKOWSKA I. | POL |
| 7 | STADNIK Yana | GBR |
| 8 | DARANUTSA Khrystyna | UKR |
| 9 | TSOGTBAZAR Enkhjargal | MGL |
| 10 | KIM Hyung-Joo | KOR |
| 11 | CROITORU Cristina Raluca | ROU |
| 12 | MEZIEN Maroi | TUN |
| 13 | KALADZINSKAYA Vanesa | BLR |
| 14 | BERMUDEZ Patricia Alejandra | ARG |
| 15 | SEZER Sumeyya | TUR |
| 16 | BLASZKA Jessica Cornelia | NED |
| 17 | DEVI Nirmala | IND |
| 18 | CARIPA CASTILLO Mayelis Yesenia | VEN |
| 19 | ABUTALIPOVA Eleonora | KAZ |
| 20 | LAMPE Alyssa Rae | USA |
| 21 | MEDRANO CUELLAR Ingrid Xiomara | ESA |
| 22 | PSATHA Fani | GRE |
| 23 | SANCHEZ PARRA Sara Maria | ESP |
| 24 | NURMATOVA Mikhrniso | KGZ |
| 25 | SCHELLIN Jaqueline Saskia | GER |



Classement

Senior World Championships



STYLE : FW 51 kg

1 - Or / Gold



KOHUT Oleksandra

2 - Argent / Silver



HORIUCHI Yu

3 - Bronze



MATTSSON Sofia Magdalena RAKHMANOVA Zamira

| Classement | Nom - Name | Pays - Country |
|------------|-------------------------------|----------------|
| 1 | KOHUT Oleksandra | UKR |
| 2 | HORIUCHI Yu | JPN |
| 3 | MATTSSON S. | SWE |
| 3 | RAKHMANOVA Zamira | RUS |
| 5 | ZASINA R. | POL |
| 5 | BAKATYUK Tatyana | KAZ |
| 7 | DOBRE Estera | ROU |
| 8 | SAMBOU Isabelle | SEN |
| 9 | MEDINA Jessica Kristina | USA |
| 10 | DOROGAN Anzhela | AZE |
| 11 | YLINEN Tiina Paula | FIN |
| 12 | IVANOVA YAHORAVA Maryia | BLR |
| 13 | BABITA Kumari | IND |
| 14 | BUDU Natalia | MDA |
| 15 | LI Hui | CHN |
| 15 | MACDONALD BONDY Jessica | CAN |
| 17 | SERRANO BARCELO Maria del Mar | ESP |
| 18 | DAVAASUKH Otgontsetseg | MGL |
| 19 | TOKAR Nadine Simone | SUI |
| 20 | BOUBRYEMM Vanessa Zohra | FRA |



Feuille de compétition / Competition Sheet

Senior World Championships



WORLD WRESTLING
FEDERATION
CHAMPIONSHIP

STYLE : FW 55 kg

| QUALIFICATION | | 1/8 FINALE | 1/4 FINALE | 1/2 FINALE | FINALE |
|---------------|--------------------------|---------------------------------|---------------------------------|------------|------------|
| 1 | MONTERO PEREZ M. (ESP) | 1 0 0 ESP | 2 3 6 FRA | 2 0 0 FRA | 8 0 0 AZE |
| 2 | GOMIS Anna (FRA) | 2 3 4 FRA | 3 1 3 CAN | 8 4 14 AZE | 17 3 8 JPN |
| 3 | GALLAYS J. (CAN) | 3 3 11 CAN | 5 0 0 KAZ | 15 0 0 RUS | 17 3 8 JPN |
| 4 | YANG Senlian (CHN) | 4 1 2 CHN | 6 1 4 CZE | 15 3 6 RUS | 17 3 8 JPN |
| 5 | ABDILDINA Aiyim (KAZ) | 5 3 4 KAZ | 7 0 0 NZL | 15 3 6 RUS | 17 3 8 JPN |
| 6 | MARTINAKOVA Lenka (CZE) | 6 1 4 CZE | 8 5 8 AZE | 15 3 6 RUS | 17 3 8 JPN |
| 7 | LAW Sian Eileen (NZL) | 7 0 0 NZL | 9 3 4 TUN | 15 3 6 RUS | 17 3 8 JPN |
| 8 | RATKEVICH Yuliya (AZE) | 8 5 8 AZE | 10 1 1 POL | 15 3 6 RUS | 17 3 8 JPN |
| 9 | AMRI Marwa (TUN) | 9 3 4 TUN | 11 1 2 ATAKOL Dilek (TUR) | 15 3 6 RUS | 17 3 8 JPN |
| 10 | BILENSKA S. (POL) | 10 1 1 POL | 12 0 4 KHARIV Iryna (UKR) | 15 3 6 RUS | 17 3 8 JPN |
| 11 | ATAKOL Dilek (TUR) | 11 1 1 POL | 13 5 4 SUNDEV B. (MGL) | 15 3 6 RUS | 17 3 8 JPN |
| 12 | KHARIV Iryna (UKR) | 12 0 4 KHARIV Iryna (UKR) | 14 0 0 MINGUZZI Valentina (ITA) | 15 3 6 RUS | 17 3 8 JPN |
| 13 | SUNDEV B. (MGL) | 13 1 2 MGL | 15 3 4 GUROVA Maria (RUS) | 15 3 6 RUS | 17 3 8 JPN |
| 14 | MINGUZZI Valentina (ITA) | 14 0 0 MINGUZZI Valentina (ITA) | 16 0 0 UM Ji-Eun (KOR) | 15 3 6 RUS | 17 3 8 JPN |
| 15 | GUROVA Maria (RUS) | 15 3 7 RUS | 17 5 7 YOSHIDA Saori (JPN) | 15 3 6 RUS | 17 3 8 JPN |
| 16 | UM Ji-Eun (KOR) | 16 0 0 UM Ji-Eun (KOR) | 18 3 4 KAZARYAN Tamara (UZB) | 15 3 6 RUS | 17 3 8 JPN |
| 17 | YOSHIDA Saori (JPN) | 17 4 12 JPN | 19 0 0 ANTES CASTILLO L. (ECU) | 15 3 6 RUS | 17 3 8 JPN |
| 18 | KAZARYAN Tamara (UZB) | 18 0 0 UZB | 20 1 4 SIDAKOVA Zalina (BLR) | 15 3 6 RUS | 17 3 8 JPN |
| 19 | ANTES CASTILLO L. (ECU) | 19 0 0 ANTES CASTILLO L. (ECU) | 21 3 9 SUAREZ T. (USA) | 15 3 6 RUS | 17 3 8 JPN |
| 20 | SIDAKOVA Zalina (BLR) | 20 0 4 SIDAKOVA Zalina (BLR) | 22 3 2 PAVAL Ana Maria (ROU) | 15 3 6 RUS | 17 3 8 JPN |
| 21 | SUAREZ T. (USA) | 21 10 3 USA | 23 1 2 SZABÓ Emese (HUN) | 15 3 6 RUS | 17 3 8 JPN |
| 22 | PAVAL Ana Maria (ROU) | 22 1 6 ROU | | | |
| 23 | SZABÓ Emese (HUN) | 23 2 0 HUN | | | |

17 YOSHIDA Saori (JPN)

Classement

| Cl | Pays | Nom |
|----|------|---------------------|
| 1 | JPN | YOSHIDA Saori |
| 2 | AZE | RATKEVICH Yuliya |
| 3 | FRA | GOMIS Anna |
| 3 | USA | SUAREZ T. |
| 5 | KAZ | ABDILDINA Aiyim |
| 5 | RUS | GUROVA Maria |
| 7 | MGL | SUNDEV Byambatseren |
| 8 | CAN | GALLAYS J. |
| 9 | ROU | PAVAL Ana Maria |
| 10 | POL | BILENSKA S. |
| 11 | KOR | UM Ji-Eun |
| 12 | TUN | AMRI Marwa |
| 13 | UZB | KAZARYAN Tamara |
| 14 | CZE | MARTINAKOVA Lenka |
| 15 | BLR | SIDAKOVA Zalina |
| 16 | HUN | SZABÓ Emese |
| 17 | TUR | ATAKOL Dilek |
| 18 | CHN | YANG Senlian |
| 19 | UKR | KHARIV Iryna |
| 20 | ITA | MINGUZZI Valentina |
| 20 | ECU | ANTES CASTILLO L. |
| 20 | ESP | MONTERO PEREZ M. |
| 23 | NZL | LAW Sian Eileen |

REPECHAGE

REPECHAGE FINALISTE 1

| | | |
|---------------------------|-----------|-----------|
| 7 0 0 NZL | 5 1 1 KAZ | 2 3 8 FRA |
| 5 5 4 KAZ | 2 3 8 FRA | |
| 2 GOMIS Anna (FRA) | | |

Mdaille de Bronze

REPECHAGE FINALISTE 2

| | | |
|---------------------------|------------|------------|
| 16 3 2 KOR | 21 3 6 USA | 15 0 1 RUS |
| 18 0 0 UZB | 21 3 6 USA | 15 0 1 RUS |
| 21 SUAREZ T. (USA) | | |

Mdaille de Bronze



Classement

Senior World Championships



STYLE : FW 55 kg

1 - Or / Gold



YOSHIDA Saori

2 - Argent / Silver



RATKEVICH Yuliya

3 - Bronze



GOMIS Anna



SUAREZ Tatiana Yadira

| Classement | Nom - Name | Pays - Country |
|------------|-----------------------------------|----------------|
| 1 | YOSHIDA Saori | JPN |
| 2 | RATKEVICH Yuliya | AZE |
| 3 | GOMIS Anna | FRA |
| 3 | SUAREZ T. | USA |
| 5 | ABDILDINA Aiyim | KAZ |
| 5 | GUROVA Maria | RUS |
| 7 | SUNDEV Byambatseren | MGL |
| 8 | GALLAYS Jillian Alice | CAN |
| 9 | PAVAL Ana Maria | ROU |
| 10 | BILENSKA Sylwia Barbara | POL |
| 11 | UM Ji-Eun | KOR |
| 12 | AMRI Marwa | TUN |
| 13 | KAZARYAN Tamara | UZB |
| 14 | MARTINAKOVA Lenka | CZE |
| 15 | SIDAKOVA Zalina | BLR |
| 16 | SZABÓ Emese | HUN |
| 17 | ATAKOL Dilek | TUR |
| 18 | YANG Senlian | CHN |
| 19 | KHARIV Iryna | UKR |
| 20 | MINGUZZI Valentina | ITA |
| 20 | ANTES CASTILLO Lissette Alexandra | ECU |
| 20 | MONTERO PEREZ Minerva | ESP |
| 23 | LAW Sian Eileen | NZL |



Feuille de compétition / Competition Sheet

Senior World Championships



STYLE : FW 59 kg

| QUALIFICATION | | 1/8 FINALE | 1/4 FINALE | 1/2 FINALE | FINALE |
|---------------|-----------------------------|-------------|------------|------------|------------|
| 1 | SHODA Ayako (JPN) | 1 3/6 JPN | 1 3/5 JPN | 1 1/8 JPN | 6 3/8 MGL |
| 2 | AHMADLI Sona (AZE) | 2 1/5 AZE | 2 1/5 AZE | 6 5/4 MGL | 6 3/3 MGL |
| 3 | SELLOUM FATAH M. (FRA) | 3 0/0 FRA | 4 1/2 KAZ | 6 3/3 MGL | 10 0/0 CHN |
| 4 | KALININA Olga (KAZ) | 4 5/7 KAZ | 8 0/0 BRA | 10 5/5 CHN | 10 0/0 CHN |
| 5 | VERBEEK Tonya Lynn (CAN) | 5 1/5 CAN | 10 3/3 CHN | 15 3/5 USA | 15 0/0 USA |
| 6 | SORONZONBOLD B. (MGL) | 6 3/10 MGL | 14 0/0 SWE | 15 0/0 USA | |
| 7 | VIUNOVA Ekaterina (RUS) | 7 1/3 RUS | 14 3/7 SWE | 15 0/0 USA | |
| 8 | SOUZA DA SILVA J. (BRA) | 8 3/2 BRA | 15 5/4 USA | 15 0/0 USA | |
| 9 | FILIPAVA Alena (BLR) | 9 0/0 BLR | 17 0/1 NGR | 19 0/0 USA | |
| 10 | ZHANG Lan (CHN) | 10 3/10 CHN | 19 0/0 ESP | 21 1/1 LAT | |
| 11 | PAIC G. (ROU) | 12 1/3 IND | 21 3/4 LAT | | |
| 12 | TOMAR Aika (IND) | 12 3/3 IND | | | |
| 13 | SYNYSHYN Nataliya (UKR) | 14 0/0 SWE | | | |
| 14 | MATTSSON M. (SWE) | 14 3/7 SWE | | | |
| 15 | CAMPBELL K. (USA) | 15 5/4 USA | | | |
| 16 | CRISTEA Ludmila (MDA) | 17 0/1 NGR | | | |
| 17 | OBORUDUDU Blessing (NGR) | 19 0/0 ESP | | | |
| 18 | YUSEIN T. (BUL) | 21 3/4 LAT | | | |
| 19 | FAJARDO PRIETO A. (ESP) | | | | |
| 20 | KIIAZOVIA Nestan (KGZ) | | | | |
| 21 | SKUJINA Laura (LAT) | | | | |
| 22 | FRANCISCO MENDONCA J. (GBS) | | | | |

6 SORONZONBOLD B. (MGL)

Classement

| Cl | Pays | Nom |
|----|------|-----------------------|
| 1 | MGL | SORONZONBOLD B. |
| 2 | CHN | ZHANG Lan |
| 3 | JPN | SHODA Ayako |
| 3 | SWE | MATTSSON M. |
| 5 | CAN | VERBEEK Tonya Lynn |
| 5 | USA | CAMPBELL K. |
| 7 | LAT | SKUJINA Laura |
| 8 | KAZ | KALININA Olga |
| 9 | IND | TOMAR Aika |
| 10 | BRA | SOUZA DA SILVA J. |
| 11 | NGR | OBORUDUDU Blessing |
| 12 | ESP | FAJARDO PRIETO A. |
| 13 | AZE | AHMADLI Sona |
| 14 | KGZ | KIIAZOVIA Nestan |
| 15 | RUS | VIUNOVA Ekaterina |
| 16 | MDA | CRISTEA Ludmila |
| 17 | GBS | FRANCISCO MENDONCA J. |
| 18 | ROU | PAIC G. |
| 19 | BUL | YUSEIN T. |
| 20 | BLR | FILIPAVA Alena |
| 21 | UKR | SYNYSHYN Nataliya |
| 22 | FRA | SELLOUM FATAH M. |

REPECHAGE

REPECHAGE FINALISTE 1

| | | |
|----------------------------|-----------|-----------|
| 5 3/10 CAN | 5 1/1 CAN | 1 3/2 JPN |
| 8 1/1 BRA | 1 3/2 JPN | |
| 1 SHODA Ayako (JPN) | | |

Mdaille de Bronze

REPECHAGE FINALISTE 2

| | | |
|-----------------------------|------------|------------|
| 9 1/1 BLR | 14 5/4 SWE | 15 0/0 USA |
| 14 3/2 SWE | 15 0/0 USA | |
| 14 MATTSSON M. (SWE) | | |

Mdaille de Bronze



Classement

Senior World Championships



STYLE : FW 59 kg

1 - Or / Gold



SORONZONBOLD Battsetseg

2 - Argent / Silver



ZHANG Lan

3 - Bronze



SHODA Ayako



MATTSSON Malin Johanna

| Classement | Nom - Name | Pays - Country |
|------------|---------------------------|----------------|
| 1 | SORONZONBOLD B. | MGL |
| 2 | ZHANG Lan | CHN |
| 3 | SHODA Ayako | JPN |
| 3 | MATTSSON M. | SWE |
| 5 | VERBEEK Tonya Lynn | CAN |
| 5 | CAMPBELL K. | USA |
| 7 | SKUJINA Laura | LAT |
| 8 | KALININA Olga | KAZ |
| 9 | TOMAR Alka | IND |
| 10 | SOUZA DA SILVA Joice | BRA |
| 11 | OBORUDUDU Blessing | NGR |
| 12 | FAJARDO PRIETO Aurora | ESP |
| 13 | AHMADLI Sona | AZE |
| 14 | KIIAZOVIA Nestan | KGZ |
| 15 | VIUNOVA Ekaterina | RUS |
| 16 | CRISTEA Ludmila | MDA |
| 17 | FRANCISCO MENDONCA Jacira | GBS |
| 18 | PAIC Georgiana Narcisa | ROU |
| 19 | YUSEIN Taybe Mustafa | BUL |
| 20 | FILIPAVA Alena | BLR |
| 21 | SYNYSHYN Nataliya | UKR |
| 22 | SELLOUM FATAH Meryem | FRA |



Classement

Senior World Championships



STYLE : FW 63 kg

1 - Or / Gold



ICHO Kaori

2 - Argent / Silver



PIROZHKOVA Elena

3 - Bronze



JOHANSSON Hanna Katarina



VOLOSOVA Lubov

| Classement | Nom - Name | Pays - Country |
|------------|------------------------------------|----------------|
| 1 | ICHO Kaori | JPN |
| 2 | PIROZHKOVA Elena | USA |
| 3 | JOHANSSON H. | SWE |
| 3 | VOLOSOVA Lubov | RUS |
| 5 | SASTIN Marianna | HUN |
| 5 | VIDIAUX LOPEZ K. | CUB |
| 7 | OCHIRBAT Nasanburmaa | MGL |
| 8 | ROA VELANDIA Sandra Viviana | COL |
| 9 | ENGLISH HEES Yvonne Michaela | GER |
| 10 | CORBANI Simona | ITA |
| 11 | ZUTOVA guzel | AZE |
| 12 | ZAKHAROVA Tatyana | KAZ |
| 13 | CHEN Meng | CHN |
| 14 | BOUCHARD Justine Angelle | CAN |
| 15 | MENDEZ MAYO Maria Teresa | ESP |
| 16 | PARK Sang-Eun | KOR |
| 17 | ANTAR YASSIN Nadia Ahmed | EGY |
| 18 | MAIERHOFER Stephanie | AUT |
| 19 | VASEVA Elina Lyubchova | BUL |
| 20 | HOU Min-Wen | TPE |
| 21 | MILAZAR Marie Anne-Joyce | MRI |
| 22 | HUCHOK Anastasiya | BLR |
| 22 | MIRZAYEVA Gavhar | UZB |
| 22 | PRIETO BOKHASHVILI Audrey Laurence | FRA |
| 22 | PAPAVASILEIOU Agoro | GRE |
| 26 | MICHALIK Monika Ewa | POL |
| 27 | KVYATKOVSKA Maryana | UKR |
| 28 | RAFALIHARISOLO Maminirina Judicaël | MAD |



Feuille de compétition / Competition Sheet

Senior World Championships



WORLD WRESTLING
FEDERATION
CHAMPIONSHIP

STYLE : FW 67 kg

| QUALIFICATION | | 1/8 FINALE | 1/4 FINALE | 1/2 FINALE | FINALE |
|---------------|-------------------------------------|------------|------------|------------|------------|
| 1 | KARTASHOVA Alena (RUS) | 1 0 1 RUS | 2 5 9 NGR | 2 1 1 NGR | 6 4 13 CAN |
| 2 | IHEANACHO Ifeoma (NGR) | 2 5 6 NGR | 3 0 0 GER | 6 3 8 CAN | 6 1 2 KAZ |
| 3 | SELMAIER Maria (GER) | 3 5 7 GER | 4 0 7 EGY | 7 0 0 JPN | 16 3 7 KAZ |
| 4 | MOUSTAFA YOUSSEF KHOURSHID E. (EGY) | 4 0 7 EGY | 5 0 0 NOR | 8 1 4 PUR | 16 3 5 KAZ |
| 5 | ERLANDSEN M. (NOR) | 5 0 0 NOR | 6 3 4 CAN | 9 1 1 USA | 16 3 2 KAZ |
| 6 | DUGRENIER Martine (CAN) | 6 5 3 CAN | 7 3 14 JPN | 10 3 6 UKR | |
| 7 | SHINKAI Mami (JPN) | 7 3 14 JPN | 8 1 4 PUR | 10 1 3 UKR | |
| 8 | MORALES GARCIA Y. (PUR) | 8 1 4 PUR | 9 1 1 USA | 12 1 1 CHN | |
| 9 | DAVIS Kristie (USA) | 9 1 1 USA | 10 3 4 UKR | 12 3 6 CHN | |
| 10 | CHERKASOVA Alla (UKR) | 10 3 4 UKR | 11 1 3 BLR | 13 0 0 MGL | |
| 11 | KHILKO Olga (BLR) | 11 1 3 BLR | 12 3 6 CHN | 14 1 3 AZE | |
| 12 | CHEN Ying (CHN) | 12 3 6 CHN | 13 0 0 MGL | 14 3 2 AZE | |
| 13 | BADRATKH O. (MGL) | 13 0 0 MGL | 14 1 3 BLR | 15 0 0 TUR | |
| 14 | SEMENTSOVA Nadya (AZE) | 14 3 2 AZE | 15 0 0 TUR | 16 3 5 KAZ | |
| 15 | ORSKAYA Burcu (TUR) | 15 0 0 TUR | 16 3 4 KAZ | 16 3 2 KAZ | |
| 16 | SHALYGINA Elena (KAZ) | 16 3 4 KAZ | | | |
| 17 | ANARBEKOVA Elgiza (KGZ) | 17 0 0 KGZ | | | |

6 DUGRENIER Martine (CAN)

Classement

| Cl | Pays | Nom |
|----|------|-------------------------------|
| 1 | CAN | DUGRENIER Martine |
| 2 | KAZ | SHALYGINA Elena |
| 3 | NGR | IHEANACHO Ifeoma |
| 3 | UKR | CHERKASOVA Alla |
| 5 | JPN | SHINKAI Mami |
| 5 | AZE | SEMENTSOVA Nadya |
| 7 | TUR | ORSKAYA Burcu |
| 8 | GER | SELMAIER Maria |
| 9 | CHN | CHEN Ying |
| 10 | PUR | MORALES GARCIA Y. |
| 11 | BLR | KHILKO Olga |
| 12 | USA | DAVIS Kristie |
| 13 | EGY | MOUSTAFA YOUSSEF KHOURSHID E. |
| 14 | RUS | KARTASHOVA Alena |
| 15 | MGL | BADRATKH Odonchimej |
| 16 | NOR | ERLANDSEN M. |
| 17 | KGZ | ANARBEKOVA Elgiza |

REPECHAGE

REPECHAGE FINALISTE 1

| | |
|-----------|-----------|
| 5 0 0 NOR | 7 0 0 JPN |
| 7 5 0 JPN | 2 5 5 NGR |

2 IHEANACHO Ifeoma (NGR)

Mdaille de Bronze

REPECHAGE FINALISTE 2

| | | |
|------------|------------|------------|
| 17 0 0 KGZ | 15 0 0 TUR | 14 0 0 AZE |
| 15 5 8 TUR | 14 3 2 AZE | 10 5 2 UKR |

10 CHERKASOVA Alla (UKR)

Mdaille de Bronze



Classement

Senior World Championships



STYLE : FW 67 kg

1 - Or / Gold



DUGRENIER Martine

2 - Argent / Silver



SHALYGINA Elena

3 - Bronze



IHEANACHO Ifeoma



CHERKASOVA Alla

| <i>Classement</i> | <i>Nom - Name</i> | <i>Pays - Country</i> |
|-------------------|---------------------------------|-----------------------|
| 1 | DUGRENIER Martine | CAN |
| 2 | SHALYGINA Elena | KAZ |
| 3 | IHEANACHO Ifeoma | NGR |
| 3 | CHERKASOVA Alla | UKR |
| 5 | SHINKAI Mami | JPN |
| 5 | SEMENTSOVA Nadya | AZE |
| 7 | ORSKAYA Burcu | TUR |
| 8 | SELMAIER Maria | GER |
| 9 | CHEN Ying | CHN |
| 10 | MORALES GARCIA Yanira | PUR |
| 11 | KHILKO Olga | BLR |
| 12 | DAVIS Kristie | USA |
| 13 | MOUSTAFA YOUSSEF KHOURSHID Enas | EGY |
| 14 | KARTASHOVA Alena | RUS |
| 15 | BADRATKH Odonchimej | MGL |
| 16 | ERLANDSEN Maja Gunvor | NOR |
| 17 | ANARBEKOVA Elgiza | KGZ |



Feuille de compétition / Competition Sheet

Senior World Championships



STYLE : FW 72 kg

| QUALIFICATION | | | 1/8 FINALE | | | 1/4 FINALE | | | 1/2 FINALE | | | FINALE | | |
|---------------|----------------------------|--|------------|---|-----|------------|---|-----|------------|---|-----|--------|---|-----|
| 1 | BUKINA Ekaterina (RUS) | | 1 | 3 | RUS | 4 | 3 | BUL | 4 | 3 | BUL | 4 | 3 | BUL |
| | | | | | | | | | | | | | | |
| 2 | ALI Annabel Laure (CMR) | | 2 | 1 | CMR | 6 | 0 | USA | 8 | 1 | SWE | 19 | 0 | CAN |
| | | | | | | | | | | | | | | |
| 3 | BENTORKI S. (FRA) | | 3 | 0 | FRA | 7 | 1 | BLR | 8 | 5 | SWE | 19 | 3 | CAN |
| | | | | | | | | | | | | | | |
| 4 | HRISTOVA S. (BUL) | | 4 | 3 | BUL | 8 | 3 | SWE | 12 | 3 | JPN | 19 | 4 | CAN |
| | | | | | | | | | | | | | | |
| 5 | IANCOLOVICI R. (ROU) | | 5 | 0 | ROU | 9 | 3 | MGL | 12 | 3 | JPN | | | |
| | | | | | | | | | | | | | | |
| 6 | LEE Stephany Keala (USA) | | 6 | 5 | USA | 10 | 0 | KAZ | 12 | 5 | JPN | | | |
| | | | | | | | | | | | | | | |
| 7 | MARZALIUK Vasilisa (BLR) | | 7 | 1 | BLR | 11 | 1 | UKR | 14 | 3 | CHN | | | |
| | | | | | | | | | | | | | | |
| 8 | FRANSSON A. (SWE) | | 8 | 3 | SWE | 11 | 3 | MGL | 14 | 0 | CHN | | | |
| | | | | | | | | | | | | | | |
| 9 | OCHIRBAT Burmaa (MGL) | | 9 | 3 | MGL | 12 | 3 | JPN | 16 | 0 | GER | | | |
| | | | | | | | | | | | | | | |
| 10 | ZHANIBEKOVA Olga (KAZ) | | 10 | 0 | KAZ | 12 | 5 | JPN | 18 | 0 | ESP | | | |
| | | | | | | | | | | | | | | |
| 11 | BURMISTROVA K. (UKR) | | 11 | 1 | UKR | 14 | 3 | CHN | 19 | 3 | CAN | | | |
| | | | | | | | | | | | | | | |
| 12 | HAMAGUCHI Kyoko (JPN) | | 12 | 3 | JPN | 14 | 0 | CHN | 19 | 5 | CAN | | | |
| | | | | | | | | | | | | | | |
| 13 | DA SILVA FERREIRA A. (BRA) | | 13 | 0 | BRA | 14 | 0 | CHN | 19 | 4 | CAN | | | |
| | | | | | | | | | | | | | | |
| 14 | LI Dan (CHN) | | 14 | 3 | CHN | 16 | 0 | GER | | | | | | |
| | | | | | | | | | | | | | | |
| 15 | KANG Han-Bit (KOR) | | 15 | 1 | KOR | 18 | 0 | ESP | | | | | | |
| | | | | | | | | | | | | | | |
| 16 | MÜLLER Maria Erika (GER) | | 16 | 3 | GER | 19 | 3 | CAN | | | | | | |
| | | | | | | | | | | | | | | |
| 17 | RIVERA SUAREZ D. (PUR) | | 17 | 0 | PUR | 19 | 4 | CAN | | | | | | |
| | | | | | | | | | | | | | | |
| 18 | UNDA GONZALEZ M. (ESP) | | 18 | 5 | ESP | | | | | | | | | |
| | | | | | | | | | | | | | | |
| 19 | AKUFFO Ohenewa (CAN) | | 19 | 3 | CAN | | | | | | | | | |
| | | | | | | | | | | | | | | |
| 20 | GURBANHAJIYEVA Z. (AZE) | | 20 | 0 | AZE | | | | | | | | | |
| | | | | | | | | | | | | | | |

4 HRISTOVA S. (BUL)

Classement

| Cl | Pays | Nom |
|----|------|----------------------|
| 1 | BUL | HRISTOVA S. |
| 2 | CAN | AKUFFO Ohenewa |
| 3 | RUS | BUKINA Ekaterina |
| 3 | JPN | HAMAGUCHI Kyoko |
| 5 | SWE | FRANSSON Anna Jenny |
| 5 | ESP | UNDA GONZALEZ M. |
| 7 | CHN | LI Dan |
| 8 | USA | LEE Stephany Keala |
| 9 | MGL | OCHIRBAT Burmaa |
| 10 | GER | MÜLLER Maria Erika |
| 11 | CMR | ALI Annabel Laure |
| 12 | UKR | BURMISTROVA K. |
| 13 | KOR | KANG Han-Bit |
| 14 | BLR | MARZALIUK Vasilisa |
| 15 | ROU | IANCOLOVICI R. |
| 16 | BRA | DA SILVA FERREIRA A. |
| 17 | PUR | RIVERA SUAREZ D. |
| 18 | KAZ | ZHANIBEKOVA Olga |
| 19 | FRA | BENTORKI S. |
| 19 | AZE | GURBANHAJIYEVA Z. |

| REPECHAGE | | |
|------------------------------|---|-------------------------------|
| REPECHAGE FINALISTE 1 | | |
| 3 | 0 | FRA |
| 1 | 3 | RUS |
| 1 | 5 | RUS |
| 8 | 1 | SWE |
| 1 | 5 | RUS |
| 1 | | BUKINA Ekaterina (RUS) |
| Mdaille de Bronze | | |
| REPECHAGE FINALISTE 2 | | |
| 20 | 0 | AZE |
| 18 | 3 | ESP |
| 14 | 1 | CHN |
| 18 | 1 | ESP |
| 12 | 3 | JPN |
| 12 | | HAMAGUCHI Kyoko (JPN) |
| Mdaille de Bronze | | |

Classement**Senior World Championships**

STYLE : FW 72 kg

**1 - Or / Gold**

HRISTOVA Stanka Zlateva

2 - Argent / Silver

AKUFFO Ohenewa

3 - Bronze

BUKINA Ekaterina



HAMAGUCHI Kyoko

| <i>Classement</i> | <i>Nom - Name</i> | <i>Pays - Country</i> |
|-------------------|----------------------------|-----------------------|
| 1 | HRISTOVA S. | BUL |
| 2 | AKUFFO Ohenewa | CAN |
| 3 | BUKINA Ekaterina | RUS |
| 3 | HAMAGUCHI Kyoko | JPN |
| 5 | FRANSSON Anna Jenny | SWE |
| 5 | UNDA GONZALEZ M. | ESP |
| 7 | LI Dan | CHN |
| 8 | LEE Stephany Keala | USA |
| 9 | OCHIRBAT Burmaa | MGL |
| 10 | MÜLLER Maria Erika | GER |
| 11 | ALI Annabel Laure | CMR |
| 12 | BURMISTROVA Kateryna | UKR |
| 13 | KANG Han-Bit | KOR |
| 14 | MARZALIUK Vasilisa | BLR |
| 15 | IANCOLOVICI Roxana Camelia | ROU |
| 16 | DA SILVA FERREIRA Aline | BRA |
| 17 | RIVERA SUAREZ Dayanara | PUR |
| 18 | ZHANIBEKOVA Olga | KAZ |
| 19 | BENTORKI Shéhèrazade | FRA |
| 19 | GURBANHAJIYEVA Zumrud | AZE |

SENIOR WORLD CHAMPIONSHIPS



MOSCOW (RUS)

2010-09-06 - 2010-09-12 2010

Résultats - Results

Lutte Greco-Romaine - Greco-Roman



**Liste des arbitres / Referee list****Senior World Championships**WORLD WRESTLING
CHAMPIONSHIP

| N° | Licence | Pays Country | Nom - Last Name | Prénom - First Name |
|----|---------|-----------------|-----------------|---------------------|
| | 3106 | BUL | KOSTADINOV | Iantcho |
| | 1079 | CUB | MOLINA GONZALEZ | Guillermo Orestes |
| | 2083 | FIN | TOIVOLA | Karri |
| | 3077 | POL | BRUDZINSKI | Grzegorz |
| | 1734 | RUS | TULUPOV | Vitaly |
| | 2551 | SUI | NOBS | Marianne |
| | 2525 | TUN | BOUAZIZ | Kamel |
| | 770 | USA | TUCCI | Rick |
| | 3129 | UZB | MIHAYILOV | Konstantin |
| 1 | 1598 | CAN | MACKAY | Lee Ronald |
| 2 | 3456 | HUN | PÉTERI | László |
| 3 | 3187 | IRI | TALEBI | Bahman |
| 4 | 3520 | TUR | CICIOGLU | Ibrahim |
| 5 | 3364 | CRO | PETANJEK | Davor |
| 6 | 2224 | GRE | PAGONIS | Vassilios |
| 7 | 2424 | SUI | MEIER | Viktor |
| 8 | 3218 | JPN | ASHIDA | Takaharu |
| 9 | 3267 | RUS | NOVAKOVSKIY | Sergey |
| 10 | 3175 | FIN | TALVITIE | Jaakko |
| 11 | 3213 | JPN | SAITO | Osamu |
| 12 | 4356 | ITA | DÓZSA | Edit |
| 13 | 3826 | SUI | PUTALLAZ | Claude-Alain |
| 14 | 3924 | USA | ERRETT | Zach |
| 15 | 3334 | UKR | KOLENKOV | Olexandr |
| 16 | 3349 | KGZ | KULMATOV | Kochkor |
| 17 | 2559 | GRE | HAMAKOS | Georgios |
| 18 | 2250 | FRA | AIT BRAHAM | Robert |
| 19 | 3231 | TPE | JANG | Tsong-Rong |
| 20 | 3524 | EST | AROLD | Peep |
| 21 | 1351 | MGL | BASKHUU | Aduuch |
| 22 | 3291 | CHN | ZHANG | Xia |
| 24 | 2212 | BUL | ANTOV | Petar |
| 25 | 2541 | ROU | LAZAR | Ovidiu |
| 26 | 3417 | TUR | CEKER | Bekir |
| 27 | 3749 | RUS | KRIKOV | Andrei |
| 28 | 2730 | ITA | NULLI GABBIANI | Giampiero |
| 29 | 3994 | KOR | CHIN | Hyung-Kyun |
| 30 | 3052 | IRI | TAHMASABI | Ali Akbar |
| 31 | 2231 | COL | VELEZ | Gustavo de Jesus |

**Liste des arbitres / Referee list****Senior World Championships**

| N° | Licence | Pays Country | Nom - Last Name | Prénom - First Name |
|-----------|----------------|-------------------------|------------------------|----------------------------|
| 32 | 3788 | GRE | MIGIPI | Anastasia |
| 33 | 4357 | HUN | BACSA | Péter |
| 34 | 2546 | FRA | LE GLEUT | Régine |
| 35 | 3076 | POL | GLAZ | Andrzej |
| 36 | 2686 | USA | CLARK | Tom |
| 37 | 2513 | GEO | MACHAIDZE | Edisher |
| 38 | 2385 | MAR | MOCHAFFAA | Noredine |
| 39 | 2346 | GER | PROBST | Eberhard |
| 40 | 3284 | UZB | GULAMOV | Tokhir |
| 41 | 2818 | CYP | LOUKA | Loukas |
| 42 | 3286 | CHN | PAN | Hongjun |
| 43 | 3709 | CAN | FRENCH | David |

Nombre d'arbitres - Number of Referee

51



Liste des nations / Countries List

















































Senior World Championships

STYLE GR



WORLD WRESTLING
FEDERATION
CHAMPIONSHIP

Pays - Country

| | | |
|---|------------------|-----|
|  | AFRIQUE DU SUD | RSA |
|  | ALGERIE | ALG |
|  | ALLEMAGNE | GER |
|  | ARGENTINE | ARG |
|  | ARMENIE | ARM |
|  | AUSTRALIE | AUS |
|  | AUTRICHE | AUT |
|  | AZERBAIDJAN | AZE |
|  | BELARUS | BLR |
|  | BULGARIE | BUL |
|  | CHILI | CHI |
|  | CHINE | CHN |
|  | CHINESE TAIPEI | TPE |
|  | COLOMBIE | COL |
|  | COREE | KOR |
|  | CROATIE | CRO |
|  | CUBA | CUB |
|  | DOMINICAINE REP. | DOM |
|  | E. F. MICRONESIE | FSM |
|  | EGYPTE | EGY |
|  | EQUATEUR | ECU |
|  | ESPAGNE | ESP |
|  | ESTONIE | EST |
|  | ETATS-UNIS | USA |
|  | FINLANDE | FIN |
|  | FRANCE | FRA |
|  | GEORGIE | GEO |
|  | GRECE | GRE |
|  | GUAM | GUM |
|  | HONGRIE | HUN |
|  | ILES SALOMON | SOL |
|  | INDE | IND |
|  | IRAN R.I. | IRI |
|  | ISRAEL | ISR |
|  | ITALIE | ITA |
|  | JAPON | JPN |
|  | JORDANIE | JOR |
|  | KAZAKHSTAN | KAZ |
|  | KIRGIZSTAN | KGZ |
|  | LETTONIE | LAT |
|  | LITUANIE | LTU |
|  | MAROC | MAR |
|  | MOLDAVIE | MDA |
|  | NICARAGUA | NCA |
|  | NORVEGE | NOR |
|  | OUZBEKISTAN | UZB |
|  | PALAU | PLW |
|  | POLOGNE | POL |



Liste des nations / Countries List

Senior World Championships

STYLE GR



| | | |
|---|--------------|-----|
|  | PORTUGAL | POR |
|  | ROUMANIE | ROU |
|  | RUSSIE | RUS |
|  | SAINT-MARIN | SMR |
|  | SERBIE | SRB |
|  | SLOVAQUIE | SVK |
|  | SLOVENIE | SLO |
|  | SUEDE | SWE |
|  | SUISSE | SUI |
|  | TADJIKISTAN | TJK |
|  | TCHEQUE REP. | CZE |
|  | TUNISIE | TUN |
|  | TURKMENISTAN | TKM |
|  | TURQUIE | TUR |
|  | UKRAINE | UKR |
|  | VENEZUELA | VEN |

Nombre de nations - Number of Countries 64



Nombre d'engagés par nation / Number of Entries By Country

Senior World Championships

STYLE GR



| <i>Pays - Country</i> | <i>55 KG</i> | <i>60 KG</i> | <i>66 KG</i> | <i>74 KG</i> | <i>84 KG</i> | <i>96 KG</i> | <i>120 KG</i> | <i>TOTAL</i> |
|-----------------------|--------------|--------------|--------------|--------------|--------------|--------------|---------------|--------------|
| KAZ | 1 | 1 | 1 | 1 | 1 | 1 | 1 | 7 |
| KGZ | 1 | 1 | 1 | 1 | 1 | | 1 | 6 |
| KOR | 1 | 1 | 1 | 1 | 1 | 1 | | 6 |
| LAT | | | | 1 | | | | 1 |
| LTU | | 1 | | 1 | 1 | 1 | 1 | 5 |
| MAR | | | | 1 | | | | 1 |
| MDA | 1 | | 1 | | 1 | 1 | | 4 |
| NCA | | | | | 1 | | | 1 |
| NOR | | | 1 | | | | | 1 |
| PLW | 1 | | | | | | | 1 |
| POL | 1 | 1 | 1 | 1 | 1 | 1 | 1 | 7 |
| POR | | | 1 | | | | | 1 |
| ROU | 1 | 1 | 1 | | | 1 | | 4 |
| RSA | | | | 1 | | 1 | | 2 |
| RUS | 1 | 1 | 1 | 1 | 1 | 1 | 1 | 7 |
| SLO | | | | 1 | 1 | | | 2 |
| SMR | | | | | | 1 | | 1 |
| SOL | | | | 1 | | | | 1 |
| SRB | | 1 | 1 | | 1 | | 1 | 4 |
| SUI | | 1 | 1 | 1 | | | | 3 |
| SVK | | | | | 1 | 1 | | 2 |
| SWE | | | 1 | 1 | 1 | 1 | 1 | 5 |
| TJK | | | | | | | 1 | 1 |
| TKM | | 1 | 1 | | 1 | | | 3 |
| TPE | | | | | 1 | | | 1 |
| TUN | | | | | 1 | | | 1 |
| TUR | 1 | 1 | 1 | 1 | 1 | 1 | 1 | 7 |
| UKR | 1 | 1 | 1 | 1 | 1 | 1 | 1 | 7 |
| USA | 1 | 1 | 1 | 1 | 1 | 1 | 1 | 7 |
| UZB | 1 | 1 | 1 | 1 | 1 | 1 | 1 | 7 |
| VEN | | | | | 1 | | | 1 |
| TOTAL | 34 | 31 | 36 | 39 | 40 | 34 | 31 | 245 |



Liste des Engagés par pays / Entry-List By Country

Senior World Championships

STYLE GR



ALGERIA (ALG)

Chef de délégation / Team Leader : CHEBBAH, Rabah

Entraîneur / Coach : BENDJEDAA, Mazouz

Lutteur(s) / Wrestler(s) :

| | |
|-------|-----------------------|
| 55 kg | BOUTERFESSA, Mohammed |
| 66 kg | SERIR, Mohamed |

ARGENTINA (ARG)

Chef de délégation / Team Leader : IGLESIAS, Daniel Alfredo

Entraîneur / Coach : BROSCHINI, Javier

Lutteur(s) / Wrestler(s) :

| | |
|-------|--------------------------|
| 74 kg | BARRIO, Francisco Albano |
|-------|--------------------------|

ARMENIA (ARM)

Lutteur(s) / Wrestler(s) :

| | |
|--------|--------------------|
| 55 kg | AMOYAN, Roman |
| 60 kg | JUHARYAN, Vahan |
| 66 kg | ADIKYAN, Arman |
| 74 kg | JULFALAKYAN, Arsen |
| 84 kg | FOROV, Denis |
| 96 kg | TONOYAN, Sargis |
| 120 kg | PATRIKEEV, Yuri |

AUSTRALIA (AUS)

Chef de délégation / Team Leader : SAUL, John

Entraîneur / Coach : POPOV, Vladimir
NAZARYAN, Ashot

Kiné / Medical Staff : SAFANIEV, Marc

Lutteur(s) / Wrestler(s) :

| | |
|--------|--------------------------|
| 55 kg | PARKER, Shane Norman |
| 74 kg | SHAHSVAN, Hassan |
| 96 kg | FKIRI, Hassene Ben Amara |
| 120 kg | POPOV, Ivan |

AUSTRIA (AUT)

Chef de délégation / Team Leader : OSTERMANN, Heinz



Liste des Engagés par pays / Entry-List By Country

Senior World Championships



STYLE GR

Entraîneur / Coach : KOSMATA, Peter
Médecin / Medical Staff : AICHNER, Alexander
Lutteur(s) / Wrestler(s) :
84 kg HRUSTANOVIC, Amer
96 kg HÖRMANN, Lukas

AZERBAIJAN (AZE)

Chef de délégation / Team Leader : RZAYEV, Yashar
EYVAZOV, Tofig
Entraîneur / Coach : MANSUROV, Farid
ALIYEV, Akif
RAJABOV, Nuraddin
Médecin / Medical Staff : ZEYNALOV, Samir
ALIYEVA, Asmar
ALIYEV, Rauf
Kiné / Medical Staff : ISMAYILOV, Seymur
CHERNOVA, Yana
ALIYEV, Khanoghlan
Lutteur(s) / Wrestler(s) :
55 kg ALIYEV, Elchin
60 kg ALIYEV, Hasan
66 kg RAHIMOV, Vitaliy
74 kg HUSEYNOV, Rafig
84 kg TAHMASIBI, Saman
96 kg HUMBATOV, Sabuhi
120 kg MEHRALIYEV, Zaur

BELARUS (BLR)

Chef de délégation / Team Leader : TSITOU, Ivan
MAJYDAU, Kamandar
Entraîneur / Coach : SAPUNOU, Gennady
ZIMIN, Siarhei
Médecin / Medical Staff : ZHUKOUSKI, A.
SVADKOUSKAYA, K.
YAKAULEU, Aliaksandr
Kiné / Medical Staff : HASPADARYK, A.
MIKHAILOUSKI, Aliaksandr
Lutteur(s) / Wrestler(s) :



Liste des Engagés par pays / Entry-List By Country

Senior World Championships



STYLE GR

| | |
|--------|------------------------|
| 55 kg | HUZAU, Ivan |
| 60 kg | ALENSKI, Dzmitry |
| 66 kg | KILOU, Kazbek |
| 74 kg | KIKINIOU, Aliaksandr |
| 84 kg | HRABOVIK, Aliaksandr |
| 96 kg | DZEINICHENKA, Tsimafei |
| 120 kg | CHUGOSHVILI, Ioseb |

BULGARIA (BUL)

Chef de délégation / Team Leader : JORDANOV, Valentin

Entraîneur / Coach : TZENOV, Bratan
STOIANOV, Stoian
GERGOV, Nikolay
ANGELOV, Stefan

Médecin / Medical Staff : STRUGAROV, Stefan

Kiné / Medical Staff : DIMITROV, Stoyan

Kiné / Medical Staff : BAYAZIT, Mahmud
STANCHEV, Stancho

Lutteur(s) / Wrestler(s) :

| | |
|-------|-------------------------|
| 55 kg | VENKOV, Venelin Petkov |
| 60 kg | ANGELOV, Ivo Serafimov |
| 66 kg | EMILIYAN, Todorov |
| 74 kg | LLIYAN, Todorov |
| 84 kg | MARINOV, Hristo Diyanov |
| 96 kg | DINCHEV, Kaloyan Ivanov |

CHILE (CHI)

Lutteur(s) / Wrestler(s) :

| | |
|-------|-----------------------------------|
| 66 kg | HUBERMAN GUERRERO, Zairo Lisandro |
|-------|-----------------------------------|

CHINA (CHN)

Chef de délégation / Team Leader : LIU, Zhenduo
XUE, Lian
DONG, Shenghui

Entraîneur / Coach : WANG, Xiaoqi
WANG, Jianming

Médecin / Medical Staff : YANG, Chao

Kiné / Medical Staff : ZHAO, Fan



Liste des Engagés par pays / Entry-List By Country

Senior World Championships

STYLE GR



Lutteur(s) / Wrestler(s) :

| | |
|--------|----------------|
| 55 kg | WANG, Lumin |
| 60 kg | WAN, Feihu |
| 66 kg | WANG, Hu |
| 74 kg | WANG, Bingxuan |
| 84 kg | DUAN, Ning |
| 96 kg | HOU, Zhenlin |
| 120 kg | NIE, Xiaoming |

COLOMBIA (COL)

Lutteur(s) / Wrestler(s) :

| | |
|-------|---------------------|
| 84 kg | MOSQUERA, Christian |
|-------|---------------------|

CROATIA (CRO)

Chef de délégation / Team Leader : BERGOVIC, Vladimir

Entraîneur / Coach : SEKULIC, Vladimir

BAIC, Mario

Médecin / Medical Staff : IVANCI, Ivan

Kiné / Medical Staff : PANIC, Pero

RUNAC, Alen

Lutteur(s) / Wrestler(s) :

| | |
|-------|------------------|
| 60 kg | SOKOL, Tonimir |
| 66 kg | JANECIC, Danijel |
| 74 kg | ZUGAJ, Neven |
| 84 kg | ZUGAJ, Nenad |
| 96 kg | HOGAC, Sinisa |

CUBA (CUB)

Chef de délégation / Team Leader : PEREZ TELLEZ, Eduardo

Entraîneur / Coach : ULACIA GONZALEZ, Carlos

VAL BARGUEIRAS, Pedro

Médecin / Medical Staff : MONTESINOS FLORES, Francisco

Lutteur(s) / Wrestler(s) :

| | |
|--------|---------------------------------|
| 55 kg | BALART MARIN, Gustavo Eddy |
| 74 kg | CONSUEGRA PANFE, Mayli Raul |
| 84 kg | SHOREY HERNANDEZ, Pablo Enrique |
| 96 kg | ESTRADA FALCON, Yunior |
| 120 kg | LOPEZ NUNEZ, Mijain |



Liste des Engagés par pays / Entry-List By Country

Senior World Championships

STYLE GR



CZECH REPUBLIC (CZE)

Chef de délégation / Team Leader : VARGA, Ervin
Entraîneur / Coach : KHUTORNOY, German

Lutteur(s) / Wrestler(s) :

| | |
|--------|----------------|
| 55 kg | HOCKO, Jan |
| 60 kg | ULIP, Ondrej |
| 74 kg | SOBECKY, Tomas |
| 84 kg | OMAROV, Artur |
| 96 kg | VALA, David |
| 120 kg | SVEC, Marek |

DOMINICA (DOM)

Entraîneur / Coach : MELLA SEGURA, Rafael

Lutteur(s) / Wrestler(s) :

| | |
|-------|---------------------------|
| 60 kg | RAMIREZ, Jansel Rafael |
| 74 kg | MOTA BREA, Anyelo Alberto |

ECUADOR (ECU)

Lutteur(s) / Wrestler(s) :

| | |
|-------|--------------------------------|
| 60 kg | MONTANO ARROYO, Andres Roberto |
|-------|--------------------------------|

EGYPT (EGY)

Lutteur(s) / Wrestler(s) :

| | |
|-------|------------------------------|
| 55 kg | HASSAN ABDELAAL, Mostafa |
| 60 kg | ABDELMONEM, Sayed Hamed |
| 96 kg | ABDELFATAH, Mohammed Ibrahim |

ESTONIA (EST)

Chef de délégation / Team Leader : PRIIMAGI, Heino
LAND, Urmas

Entraîneur / Coach : POLLUSTE, Henn
KARD, Mehis

Médecin / Medical Staff : SARAPUU, Elar
PÄRNA, Lauri

Lutteur(s) / Wrestler(s) :

| | |
|-------|----------------|
| 55 kg | ZEINALOV, Anar |
|-------|----------------|



Liste des Engagés par pays / Entry-List By Country

Senior World Championships



STYLE GR

| | |
|--------|-------------------|
| 84 kg | APS, Eerik |
| 96 kg | KARELSON, Richard |
| 120 kg | NABI, Heiki |

FINLAND (FIN)

| | |
|---|---|
| Chef de délégation / Team Leader : | RAUHALA, Jukka |
| Entraîneur / Coach : | VIRTANEN, Juha YLI-HANNUKSELA, Marko |
| Médecin / Medical Staff : | LEHTO, Mika |
| Kiné / Medical Staff : | NIEMI, Pentti |

Lutteur(s) / Wrestler(s) :

| | |
|--------|---------------------------|
| 55 kg | HAAPAMÄKI, Jani Jukka |
| 60 kg | ALA-HUIKKU, Jarkko Tapani |
| 66 kg | VALIMAKI, Tero Seppo |
| 74 kg | MOISIO, Valtteri mikael |
| 84 kg | HIETANIEMI, Rami Antero |
| 120 kg | LALLI, Taisto henrik |

FRANCE (FRA)

| | |
|---|---|
| Chef de délégation / Team Leader : | LASSUYE, François |
| Entraîneur / Coach : | MOURIER, Patrice CARDEY, Jean-Marc |
| Médecin / Medical Staff : | ROUGEE, Philippe VITALI, Eric |
| Kiné / Medical Staff : | ROUGEE, Guillaume BREARD, Jean GANGLOFF, Philippe |

Lutteur(s) / Wrestler(s) :

| | |
|--------|--------------------------------|
| 60 kg | BELMADANI, Tarik |
| 66 kg | GUENOT, Steeve François Fabien |
| 74 kg | GUENOT, Christophe René Marcel |
| 84 kg | NOUMONVI, Mélonin |
| 120 kg | SZCZEPANIAK, Yannick |

GEORGIA (GEO)

| | |
|---|------------------------------------|
| Chef de délégation / Team Leader : | GESTADZE, Kakha |
| Entraîneur / Coach : | DARCHIA, Begi TATISHVILI, Otari |



Liste des Engagés par pays / Entry-List By Country

Senior World Championships



STYLE GR

| | |
|-----------------------------------|-----------------------|
| | CHACHUA, Akaki |
| Médecin / Medical Staff : | KAKHABRISHVILI, Zurab |
| Kiné / Medical Staff : | KELEKHASHVILI, Jemal |
| Lutteur(s) / Wrestler(s) : | |
| 55 kg | GOGITADZE, Lasha |
| 60 kg | LASHKHI, Revaz |
| 66 kg | TSKHADAIA, Manuchar |
| 74 kg | KVIRKELIA, Manuchar |
| 84 kg | GEGESHIDZE, Vladimer |
| 96 kg | JABIDZE, Soso |
| 120 kg | PHERSELIDZE, Guram |

GERMANY (GER)

| | |
|---|---|
| Chef de délégation / Team Leader : | SCHMENGLER, Detlef |
| Entraîneur / Coach : | BULLMAN, Maik HARTMANN, Frank LEVERMANN, Jörn |
| Médecin / Medical Staff : | GSTÖTTNER, Hans KOLTZ, Christian |
| Kiné / Medical Staff : | MARNETTE, Heinz KRASS, Wrner FRANZ, Axel |
| Lutteur(s) / Wrestler(s) : | |
| 55 kg | CRUSIUS, Florian |
| 66 kg | FETZER, Christian |
| 74 kg | SCHNEIDER, Konstantin |
| 84 kg | FISCHER, Jan |
| 96 kg | ENGLICH, Mirko |
| 120 kg | BOEHRINGER, Ralf Walter |

GREECE (GRE)

| | |
|---|------------------------|
| Chef de délégation / Team Leader : | GALAKTOPOULOS, Petros |
| Entraîneur / Coach : | APOSTOLOU, Nikos |
| Lutteur(s) / Wrestler(s) : | |
| 55 kg | TERSENIDIS, Vasileios |
| 66 kg | PAROTSIDIS, Loannis |
| 74 kg | MANOUILIDIS, Petros |
| 84 kg | TOUNOUSIDIS, Theodoros |



Liste des Engagés par pays / Entry-List By Country

Senior World Championships

STYLE GR



GUAM (GUM)

Lutteur(s) / Wrestler(s) :

66 kg JOSEPH, Lopez

HUNGARY (HUN)

Chef de délégation / Team Leader : MAROTHY, Istvan

Médecin / Medical Staff : BAKANEK, Gyorgy

Kiné / Medical Staff : HADI, Gegerly

Lutteur(s) / Wrestler(s) :

55 kg MÓDOS, Péter
66 kg LŐRINCZ, Tamás
74 kg BÁCSI, Péter
84 kg DAJKA, Zsolt
96 kg NÉMETH, Iván
120 kg DEÁK-BÁRDOS, Mihály

INDIA (IND)

Entraîneur / Coach : MAKHARZADE, Emzard

MAHABIR, Prasad

Kiné / Medical Staff : PERIVINKAL, Kaur

RAHUL, Shamra

GURPREET, Singh

Lutteur(s) / Wrestler(s) :

55 kg RAJENDER, Kumar
60 kg RAVINDER, Singh
66 kg SUNIL, Kumar
120 kg DALAL, Dharmender

IRAN R.I. (IRI)

Chef de délégation / Team Leader : OLIA, Jafar

Entraîneur / Coach : BANA, Mohammad

KHEIRABADI, J.

ESFANDIARIFAR, I.

ESMAEINEZHAD, H.

JAZINI, R.

Médecin / Medical Staff : AMIRSASAN, Ramin

TAHERI, Ali

Kiné / Medical Staff : REFETOV, Rais Behaydinov



Liste des Engagés par pays / Entry-List By Country

Senior World Championships

STYLE GR



Lutteur(s) / Wrestler(s) :

| | |
|--------|-----------------------------------|
| 55 kg | SORYAN REIHANPOUR, Hamid Mohammad |
| 60 kg | NOROOZI, Omid Haji |
| 66 kg | ABDVALI, Saeid Morad |
| 74 kg | MOHAMMADI, Mehdi Rahman |
| 84 kg | NEMATPOUR, Taleb Nariman |
| 96 kg | ALIAKBARI, Amir Aziz |
| 120 kg | GHOORBANI GOLDASTEHEH, Mohammad |

ISRAEL (ISR)

Chef de délégation / Team Leader : TSITSIASHVILI, Gocha

Entraîneur / Coach : ZIMKIMD, Ariel

Lutteur(s) / Wrestler(s) :

| | |
|--------|--------------------|
| 55 kg | CARIUR, Vladimir |
| 74 kg | SHAFRAN, Ilya |
| 84 kg | NICKOLAEV, Denis |
| 120 kg | GURALSKI, Vladimir |

ITALY (ITA)

Chef de délégation / Team Leader : ALBANESE, Aldo

Entraîneur / Coach : OLIVERA HERNANDEZ, Jos Mario

GIUNTA, Giuseppe

Kiné / Medical Staff : PILOTTI, Pietro

Lutteur(s) / Wrestler(s) :

| | |
|--------|-----------------------|
| 55 kg | MANEA, Federico |
| 74 kg | SCARAMUZZI, Saverio |
| 96 kg | TIMONCINI, Daigoro |
| 120 kg | FICARA, Rocco Daniele |

JAPAN (JPN)

Chef de délégation / Team Leader : MARUYAMA, Hideji

HASE, Hiroshi

Entraîneur / Coach : MOTOKI, Yasutochi

KUKIDOME, Takeshi

Médecin / Medical Staff : NAKAJIMA, Kohei

KOMATSU, Yutaka

Kiné / Medical Staff : TAKEUCHI, Tsuyoshi

KAWASAKI, Atsushi



Liste des Engagés par pays / Entry-List By Country

Senior World Championships

STYLE GR



Lutteur(s) / Wrestler(s) :

| | |
|--------|--------------------|
| 55 kg | HASEGAWA, Kohei |
| 60 kg | MATSUMOTO, Ryutaro |
| 66 kg | FUJIMURA, Tsutomu |
| 74 kg | KANAKUBO, Takehiro |
| 84 kg | SAIKAWA, Norikatsu |
| 96 kg | KITAMURA, Katsuya |
| 120 kg | SHINJO, Hirokazu |

JORDAN (JOR)

Lutteur(s) / Wrestler(s) :

| | |
|--------|-----------------|
| 96 kg | YAHIA, Mohammad |
| 120 kg | HANI, Salah |

KAZAKHSTAN (KAZ)

Lutteur(s) / Wrestler(s) :

| | |
|--------|----------------------|
| 55 kg | AZKENOV, Zhangeldy |
| 60 kg | KEPISPAYEV, Almat |
| 66 kg | BAYAKHMETOV, Darkhan |
| 74 kg | MELYOSHIN, Roman |
| 84 kg | OZDIYEV, Alkhazur |
| 96 kg | MAMBETOV, Asset |
| 120 kg | TINALIYEV, Nurmakhan |

KYRGYZSTAN (KGZ)

Chef de délégation / Team Leader : TURGANBAEV, Melis

Entraîneur / Coach : ALYKULOV, E.

USHUROV, Farkhad

Médecin / Medical Staff : ALISHEVA, Baktygul

Kiné / Medical Staff : BATYRBЕКOV, A.

Lutteur(s) / Wrestler(s) :

| | |
|--------|-----------------------|
| 55 kg | ERALIEV, Arsen |
| 60 kg | TIUMENBAEV, Ruslan |
| 66 kg | BEGALIEV, Kanatbek |
| 74 kg | KOBONOV, Daniyar |
| 84 kg | KARACHOLOKOV, Ulukbek |
| 120 kg | RAMONOV, Murat |



Liste des Engagés par pays / Entry-List By Country

Senior World Championships

STYLE GR



LATVIA (LAT)

Entraîneur / Coach : CACS, Levnards

Lutteur(s) / Wrestler(s) :

74 kg VISNAKOVS, Aleksandrs

LITHUANIA (LTU)

Chef de délégation / Team Leader : DAUMANTAS, Paulius

Entraîneur / Coach : VARTANOV, Ruslan
EZRSKIS, Mindaugas

Médecin / Medical Staff : SKLIZMANTAS, Vladas

Lutteur(s) / Wrestler(s) :

60 kg VENCKAITIS, Edgaras

74 kg KAZAKEVIC, Aleksandr

84 kg LAIMUTIS, Adomaitis

96 kg LUKOSAITIS, Aldas

120 kg MIZGAITIS, Mindaugas

MICRONESIA, FEDERATED STATES OF (FSM)

Entraîneur / Coach : YOUNGHO, Ko

Lutteur(s) / Wrestler(s) :

74 kg GRAHAM, Keitani Christopher

MOLDOVA (MDA)

Chef de délégation / Team Leader : CUCUL, Mihail
CORECENCOV, Victor
PEICOV, Victor

Médecin / Medical Staff : DERIVOLKOV, Alexandr

Kiné / Medical Staff : CEREDNIK, Iurii

Lutteur(s) / Wrestler(s) :

55 kg ISLAMOVS, Donior

66 kg GAIVAN, Tudor

84 kg MOCANU, Andrian

96 kg CAZAC, Marin

MOROCCO (MAR)

Chef de délégation / Team Leader : MAGHOUSI, Ahmed



Liste des Engagés par pays / Entry-List By Country

Senior World Championships

STYLE GR



Entraîneur / Coach : LACHKAR, Ali

Lutteur(s) / Wrestler(s) :

74 kg BOUALEM, Aziz

NICARAGUA (NCA)

Chef de délégation / Team Leader : ARDESHIR, Zack Asgari

Lutteur(s) / Wrestler(s) :

84 kg ESTRADA ROMBILD, Domingo Antonio

NORWAY (NOR)

Chef de délégation / Team Leader : MOLNES, Ole-Willy

Lutteur(s) / Wrestler(s) :

66 kg THOMMESEN, Marius Blomstadli

PALAU (PLW)

Lutteur(s) / Wrestler(s) :

55 kg ELWAIS, Elgin Loren

POLAND (POL)

Lutteur(s) / Wrestler(s) :

55 kg ERSETIC, Dawid Andrzej

60 kg KARECINSKI, Dawid

66 kg SWIERK, Tomasz

74 kg KWIT, Julian

84 kg JANIKOWSKI, Damian

96 kg MALINOWSKI, Przemyslaw

120 kg BANAK, Lukasz

PORTUGAL (POR)

Chef de délégation / Team Leader : SILVA, Pedro

Entraîneur / Coach : MAIA, David

Lutteur(s) / Wrestler(s) :

66 kg PASSOS, Hugo



Liste des Engagés par pays / Entry-List By Country

Senior World Championships

STYLE GR



ROMANIA (ROU)

| | |
|-----------------------------------|------------------------|
| Entraîneur / Coach : | CARARE, Petrica |
| | OBROCEA, Dinu |
| Médecin / Medical Staff : | PLOESTEANU, Nicolae |
| Lutteur(s) / Wrestler(s) : | |
| 55 kg | MUNTEANU, Virgil |
| 60 kg | LECIU, Aurelian |
| 66 kg | PANAIT, Ion Iulian |
| 96 kg | PAPP, Robert Alexandru |

RUSSIA (RUS)

| | |
|-----------------------------------|---------------------|
| Lutteur(s) / Wrestler(s) : | |
| 55 kg | MANKIEV, Nazyr |
| 60 kg | KURAMAGOMEDOV, Zaur |
| 66 kg | VACHADZE, Ambako |
| 74 kg | SHARAFETDINOV, Imil |
| 84 kg | MISHIN, Aleksey |
| 96 kg | KHUSHTOV, Aslanbek |
| 120 kg | BAROEV, Khasan |

SAN MARINO (SMR)

| | |
|-----------------------------------|------------------|
| Lutteur(s) / Wrestler(s) : | |
| 96 kg | SCARCI, Cristian |

SERBIA (SRB)

| | |
|---|------------------------|
| Chef de délégation / Team Leader : | TRAJKEVIC, Jelko |
| Entraîneur / Coach : | DOKMAIJAC, Milorad |
| | DAMJANVIC, Sreten |
| Médecin / Medical Staff : | HISPAS, Dejai |
| Lutteur(s) / Wrestler(s) : | |
| 60 kg | STEFANEK, Davor |
| 66 kg | MAKSIMOVIC, Aleksandar |
| 84 kg | BALO, Petar |
| 120 kg | SPASIC, Milos |

SLOVAKIA (SVK)



Liste des Engagés par pays / Entry-List By Country

Senior World Championships

STYLE GR



Lutteur(s) / Wrestler(s) :

84 kg MIHALIK, Marian
96 kg KOSZEGHY, Filip

SLOVENIA (SLO)

Entraîneur / Coach : BACIC, Rade

Lutteur(s) / Wrestler(s) :

74 kg KUHAR, Jure
84 kg SERNEK, Dejan

SOLOMON ISLANDS (SOL)

Lutteur(s) / Wrestler(s) :

74 kg KATEA UERESI, Tebitara

SOUTH AFRICA (RSA)

Chef de délégation / Team Leader : PUTTER, Willem

Entraîneur / Coach : COETZEE, Nico

Lutteur(s) / Wrestler(s) :

74 kg ADDINALL, Richard Brian
96 kg BELLA-LUFU, Kakoma Hugues

SOUTH KOREA (KOR)

Chef de délégation / Team Leader : KIM, Hae-Jin

Entraîneur / Coach : BANG, Dae-Du
SON, Sang-Pil

Lutteur(s) / Wrestler(s) :

55 kg CHOI, Gyu-Jin
60 kg JUNG, Ji-Hyun
66 kg KIM, Hyeon-Woo
74 kg PARK, Jin-Sung
84 kg LEE, Se-Yeol
96 kg AN, Chang-Gun

SPAIN (ESP)

Chef de délégation / Team Leader : JAVIER IGLESIAS, Francisco

Entraîneur / Coach : SANCHEZ, Oscar



Liste des Engagés par pays / Entry-List By Country

Senior World Championships

STYLE GR



Lutteur(s) / Wrestler(s) :

| | |
|-------|------------------------------|
| 55 kg | MARTINEZ ABELLAN, Joaquin |
| 60 kg | BAGHUMYAN AGHAZARYAN, Albert |
| 66 kg | NAVARRO SANCHEZ, Ismael |

SWEDEN (SWE)

Chef de délégation / Team Leader : MALMKVIST, Lars

BESARATI, Faribolz

Entraîneur / Coach :

LJUNGBACLE, Benni

BABULFATH, Mohammad

BUGAY, Igor

Kiné / Medical Staff :

GANNBY, Ingmar

Lutteur(s) / Wrestler(s) :

| | |
|--------|------------------------------|
| 66 kg | VARDANYAN, Sharur |
| 74 kg | ROSENGREN, Robert Patrik |
| 84 kg | LJUNGBACK, Benni Christoffer |
| 96 kg | LIDBERG, Jimmy Alexander |
| 120 kg | EUREN, Johan Magnus |

SWITZERLAND (SUI)

Entraîneur / Coach : HIRT, Volker

Lutteur(s) / Wrestler(s) :

| | |
|-------|---------------------|
| 60 kg | STADELMANN, Patrick |
| 66 kg | STREBEL, Pascal |
| 74 kg | SUPPIGER, Thomas |

TAIPEI CHINESE (TPE)

Entraîneur / Coach : LIN, Ming-Chi

Lutteur(s) / Wrestler(s) :

| | |
|-------|-----------------|
| 84 kg | LIN, Ming-Hsuan |
|-------|-----------------|

TAJIKISTAN (TJK)

Lutteur(s) / Wrestler(s) :

| | |
|--------|--------------------|
| 120 kg | TUYCHIEV, Murodjon |
|--------|--------------------|

TUNISIA (TUN)



Liste des Engagés par pays / Entry-List By Country

Senior World Championships



STYLE GR

Chef de délégation / Team Leader : KHEDHRI, Ahmed
Entraîneur / Coach : BERBEROV NESHO, Andonov
Lutteur(s) / Wrestler(s) :
84 kg ACHOURI, Haikel

TURKEY (TUR)

Chef de délégation / Team Leader : YILDIZ, Ercan
CAKIR, Mustafa
GENC, Mehmet
Entraîneur / Coach : BORA, Salih
DONAT, Saban
BASAR, Hakki
YERLIKAYA, Mutallip
Médecin / Medical Staff : GUNES, Elif
SAVRANBASI, Ramazan
Kiné / Medical Staff : AKSAKAL, Suat
CELIK, Ahmet
Lutteur(s) / Wrestler(s) :
55 kg TEKIN, Ferhat
60 kg UGURLI, Abdulsamet
66 kg ARZIMANOV, Vasif
74 kg CEBI, Selcuk
84 kg AVLUCA, Nazmi
96 kg TACYILDIZ, Ahmet
120 kg KAYAALP, Riza

TURKMENISTAN (TKM)

Lutteur(s) / Wrestler(s) :
60 kg ORAZSAHADOV, Agamurad
66 kg KADYROV, Yazgeldy
84 kg ESENOV, Ylyas

UKRAINE (UKR)

Chef de délégation / Team Leader : NOSADCHYY, Eduard
KOMARNYTSKA, Tetiana
Médecin / Medical Staff : KURINNAYA, Iryna
MOSKALENKO, Oleksandr
SHVANGYRADZE, Merab



Liste des Engagés par pays / Entry-List By Country

Senior World Championships



STYLE GR

Kiné / Medical Staff :

GULKHARIEV, Igor
PARNAK, Andriy
NAZARENKO, Yuriy

Lutteur(s) / Wrestler(s) :

| | |
|--------|------------------------|
| 55 kg | RAGYMOV, Vyugar |
| 60 kg | TEMIROV, Lenur |
| 66 kg | VARDANYAN, Armen |
| 74 kg | PYSHKOV, Dmytro |
| 84 kg | RACHYBA, Vasyl |
| 96 kg | KRYOKA, Oleg |
| 120 kg | CHERNETSKYY, Oleksandr |

UNITED STATES (USA)

Lutteur(s) / Wrestler(s) :

| | |
|--------|-----------------------|
| 55 kg | MANGO, Spenser Thomas |
| 60 kg | DAVIS, Jeremiah Chaz |
| 66 kg | SAHIN, Faruk |
| 74 kg | FISHER, Jacob |
| 84 kg | CLARK, Jacob Adam |
| 96 kg | RUIZ, Justin Daniel |
| 120 kg | BYERS, Dremiel Deshon |

UZBEKISTAN (UZB)

Chef de délégation / Team Leader :

ABDUVALIYEV, Salim
TURSUNOV, Botir

Entraîneur / Coach :

DOKTURISHVILI, Alexandr
KUDRATOV, Rustam

Médecin / Medical Staff :

ABAEVA, Elena

Kiné / Medical Staff :

BIKTYAKOV, Ravil

Lutteur(s) / Wrestler(s) :

| | |
|--------|--------------------|
| 55 kg | KUZIEV, Akbar |
| 60 kg | ARIPOV, Dilshod |
| 66 kg | POGUDIN, Vladimir |
| 74 kg | MURODOV, Azizbek |
| 84 kg | MUMINOV, Jakhongir |
| 96 kg | SALDADZE, David |
| 120 kg | FARNIEV, Soslan |



Liste des Engagés par pays / Entry-List By Country

Senior World Championships

STYLE GR



VENEZUELA (VEN)

Lutteur(s) / Wrestler(s) :

84 kg

BARTOLOZZY, Edy



Feuille de compétition / Competition Sheet

Senior World Championships

STYLE : GR 55 kg



Classement

| Cl | Pays | Nom |
|----|------|----------------------------------|
| 1 | IRI | SORYAN REIHANPOUR Hamid Mohammad |
| 2 | KOR | CHOI Gyu-Jin |
| 3 | RUS | MANKIEV Nazyr |
| 3 | ARM | AMOYAN Roman |
| 5 | HUN | MÓDOS Péter |
| 5 | BUL | VENKOV Venelin Petkov |
| 7 | FIN | HAAPAMÄKI Jani Jukka |
| 8 | POL | ERSETIC Dawid Andrzej |
| 9 | AZE | ALIYEV Elchin |
| 10 | CUB | BALART MARIN Gustavo Eddy |
| 11 | KAZ | AZKENOV Zhangel'dy |
| 12 | ROU | MUNTEANU Virgil |
| 13 | IND | RAJENDER Kumar |
| 14 | GER | CRUSIUS Florian |
| 15 | TUR | TEKIN Ferhat |
| 16 | JPN | HASEGAWA Kohei |
| 17 | GEO | GOGITADZE Lasha |
| 18 | KGZ | ERALIEV Arsen |
| 19 | ISR | CARIUR Vladimir |
| 19 | USA | MANGO Spenser Thomas |

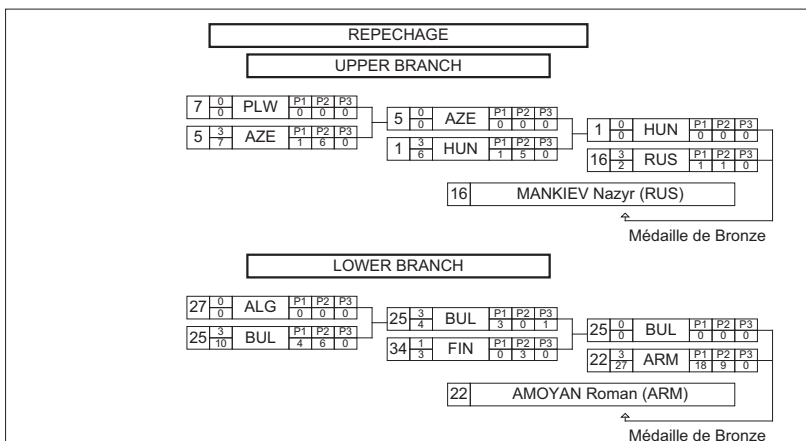



Classement

Senior World Championships



STYLE : GR 55 kg

1 - Or / Gold



SORYAN REIHANPOUR Hamid Mohamm

2 - Argent / Silver



CHOI Gyu-Jin

3 - Bronze



MANKIEV Nazyr



AMOYAN Roman

| Classement | Nom - Name | Pays - Country |
|------------|---------------------------|----------------|
| 1 | SORYAN REIHANPOUR H. | IRI |
| 2 | CHOI Gyu-Jin | KOR |
| 3 | MANKIEV Nazyr | RUS |
| 3 | AMOYAN Roman | ARM |
| 5 | MÓDOS Péter | HUN |
| 5 | VENKOV V. | BUL |
| 7 | HAAPAMÄKI Jani Jukka | FIN |
| 8 | ERSETIC Dawid Andrzej | POL |
| 9 | ALIYEV Elchin | AZE |
| 10 | BALART MARIN Gustavo Eddy | CUB |
| 11 | AZKENOV Zhangeldy | KAZ |
| 12 | MUNTEANU Virgil | ROU |
| 13 | RAJENDER Kumar | IND |
| 14 | CRUSIUS Florian | GER |
| 15 | TEKIN Ferhat | TUR |
| 16 | HASEGAWA Kohei | JPN |
| 17 | GOGITADZE Lasha | GEO |
| 18 | ERALIEV Arsen | KGZ |
| 19 | CARIUR Vladimir | ISR |
| 19 | MANGO Spenser Thomas | USA |
| 21 | MARTINEZ ABELLAN Joaquin | ESP |
| 22 | PARKER Shane Norman | AUS |
| 23 | HUZAU Ivan | BLR |
| 23 | ISLAMOV Donior | MDA |
| 25 | RAGYMOV Vyugar | UKR |
| 25 | HOCKO Jan | CZE |
| 25 | ZEINALOV Anar | EST |
| 28 | KUZIEV Akbar | UZB |
| 29 | WANG Lumin | CHN |
| 30 | HASSAN ABDELAAL Mostafa | EGY |



Classement

Senior World Championships

STYLE : GR 55 kg



| <i>Classement</i> | <i>Nom - Name</i> | <i>Pays - Country</i> |
|-------------------|----------------------|-----------------------|
| 31 | TERSENIDIS Vasileios | GRE |
| 31 | MANEA Federico | ITA |
| 33 | ELWAIS Elgin Loren | PLW |
| 34 | BOUTERFESSA Mohammed | ALG |



Feuille de compétition / Competition Sheet

Senior World Championships



WORLD WRESTLING
MOSCOW 16-17 SEPTEMBER 2013
CHAMPIONSHIP

STYLE : GR 60 kg

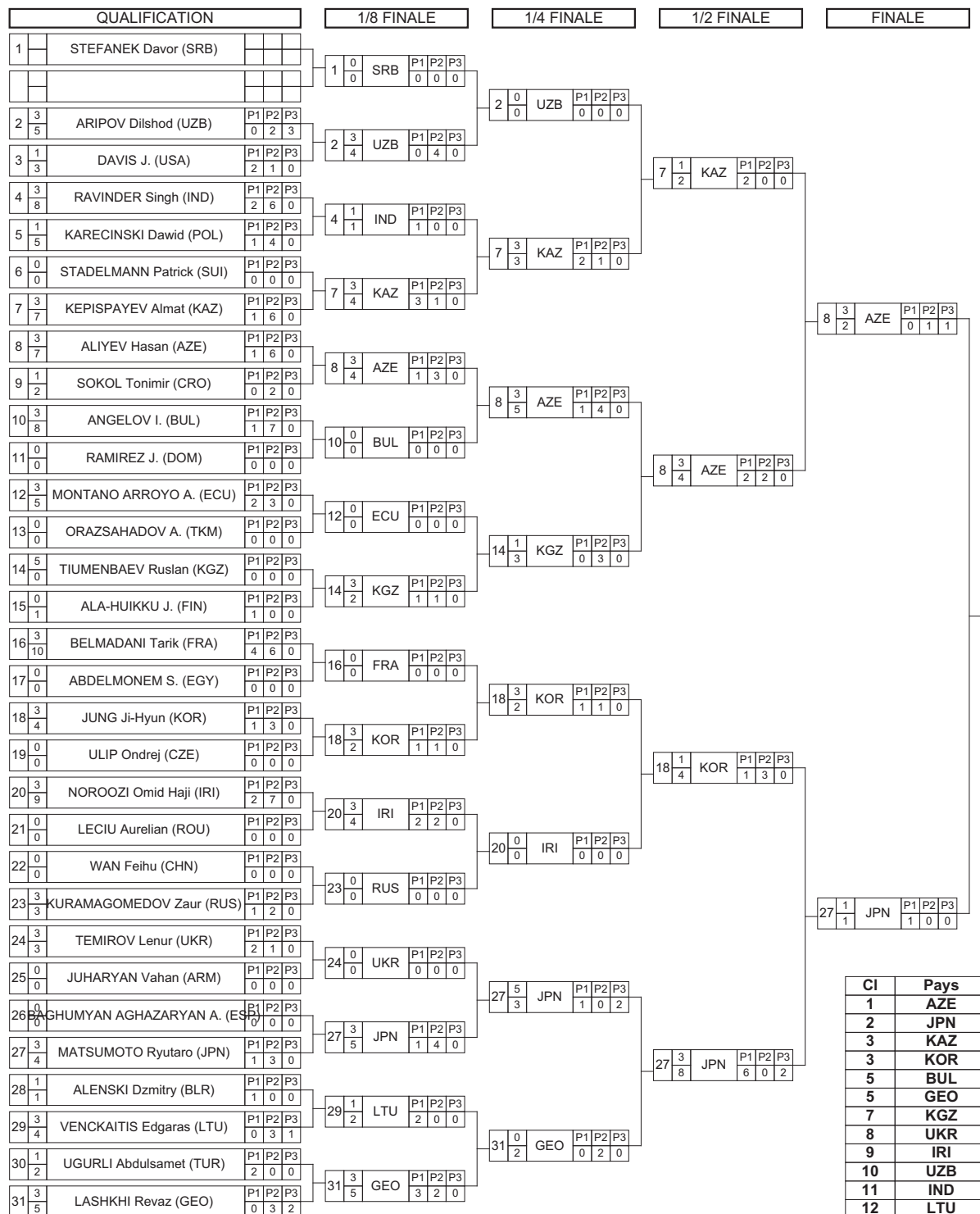

8 ALIYEV Hasan (AZE)

Classement

| Cl | Pays | Nom |
|----|------|-------------------------|
| 1 | AZE | ALIYEV Hasan |
| 2 | JPN | MATSUMOTO Ryutaro |
| 3 | KAZ | KEPISPAYEV Almat |
| 3 | KOR | JUNG Ji-Hyun |
| 5 | BUL | ANGELOV I. |
| 5 | GEO | LASHKHI Revaz |
| 7 | KGZ | TIUMENBAEV Ruslan |
| 8 | UKR | TEMIROV Lenur |
| 9 | IRI | NOROOZI Omid Haji |
| 10 | UZB | ARIPOV Dilshod |
| 11 | IND | RAVINDER Singh |
| 12 | LTU | VENCKAITIS Edgargas |
| 13 | FRA | BELMADANI Tarik |
| 14 | ECU | MONTANO ARROYO A. |
| 15 | RUS | KURAMAGOMEDOV Zaur |
| 16 | POL | KARECINSKI Dawid |
| 17 | USA | DAVIS Jeremiah Chaz |
| 18 | TUR | UGURLI Abdulsamet |
| 19 | CRO | SOKOL Tonimir |
| 20 | BLR | ALENSKI Dzmitry |
| 21 | FIN | ALA-HUIKKU J. |
| 22 | CHN | WAN Feihu |
| 22 | ARM | JUHARYAN Vahan |
| 24 | CZE | ULIP Ondrej |
| 24 | SRB | STEFANEK Davor |
| 26 | TKM | ORAZSAHADOV A. |
| 27 | SUI | STADELMANN Patrick |
| 28 | DOM | RAMIREZ J. |
| 29 | ROU | LECIU Aurelian |
| 30 | ESP | BAGHUMYAN AGHAZARYAN A. |
| 30 | EGY | ABDELMONEM S. |

REPECHAGE

REPECHAGE FINALISTE 1



REPECHAGE FINALISTE 2

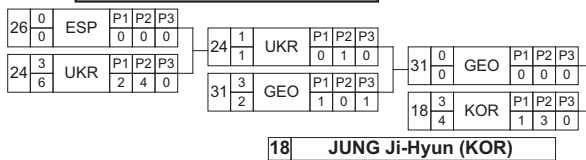



Classement

Senior World Championships

STYLE : GR 60 kg



WORLD WRESTLING
FEDERATION
CHAMPIONSHIP

1 - Or / Gold



ALIYEV Hasan

2 - Argent / Silver



MATSUMOTO Ryutaro

3 - Bronze



KEPISPAYEV Almat



JUNG Ji-Hyun

| Classement | Nom - Name | Pays - Country |
|------------|-------------------------------|----------------|
| 1 | ALIYEV Hasan | AZE |
| 2 | MATSUMOTO Ryutaro | JPN |
| 3 | KEPISPAYEV Almat | KAZ |
| 3 | JUNG Ji-Hyun | KOR |
| 5 | ANGELOV I. | BUL |
| 5 | LASHKHI Revaz | GEO |
| 7 | TIUMENBAEV Ruslan | KGZ |
| 8 | TEMIROV Lenur | UKR |
| 9 | NOROOZI Omid Haji | IRI |
| 10 | ARIPOV Dilshod | UZB |
| 11 | RAVINDER Singh | IND |
| 12 | VENCKAITIS Edgaras | LTU |
| 13 | BELMADANI Tarik | FRA |
| 14 | MONTANO ARROYO Andres Roberto | ECU |
| 15 | KURAMAGOMEDOV Zaur | RUS |
| 16 | KARECINSKI Dawid | POL |
| 17 | DAVIS Jeremiah Chaz | USA |
| 18 | UGURLI Abdulsamet | TUR |
| 19 | SOKOL Tonimir | CRO |
| 20 | ALENSKI Dzmitry | BLR |
| 21 | ALA-HUIKKU Jarkko Tapani | FIN |
| 22 | WAN Feihu | CHN |
| 22 | JUHARYAN Vahan | ARM |
| 24 | ULIP Ondrej | CZE |
| 24 | STEFANEK Davor | SRB |
| 26 | ORAZSAHADOV Agamurad | TKM |
| 27 | STADELMANN Patrick | SUI |
| 28 | RAMIREZ Jansel Rafael | DOM |
| 29 | LECIU Aurelian | ROU |
| 30 | BAGHUMYAN AGHAZARYAN Albert | ESP |
| 30 | ABDELMONEM Sayed Hamed | EGY |



Classement

Senior World Championships

STYLE : GR 60 kg



| <i>Classement</i> | <i>Nom - Name</i> | <i>Pays - Country</i> |
|-------------------|-------------------|-----------------------|
|-------------------|-------------------|-----------------------|



Feuille de compétition / Competition Sheet

Senior World Championships

STYLE : GR 66 kg



Classement

| Cl | Pays | Nom |
|----|------|-------------------------------|
| 1 | RUS | VACHADZE Ambako |
| 2 | UKR | VARDANYAN Armen |
| 3 | TUR | ARZIMANOV Vasif |
| 3 | AZE | RAHIMOV Vitaliy |
| 5 | FRA | GUENOT Steeve François Fabien |
| 5 | HUN | LÖRINCZ Tamás |
| 7 | SUI | STREBEL Pascal |
| 8 | KOR | KIM Hyeon-Woo |
| 9 | CRO | JANECIC Danijel |
| 10 | BUL | EMILIJAN Todorov |
| 11 | USA | SAHIN Faruk |
| 12 | KAZ | BAYAKHMETOV Darkhan |
| 13 | SRB | MAKSIMOVIC Aleksandar |
| 14 | IRI | ABDVALI Saeid Morad |
| 15 | ARM | ADIKYAN Arman |
| 16 | ROU | PANAIT Ion Iulian |
| 17 | FIN | VALIMAKI Tero Seppo |
| 18 | BLR | KILOU Kazbek |
| 19 | UZB | POGUDIN Vladimir |
| 20 | JPN | FUJIMURA Tsutomu |

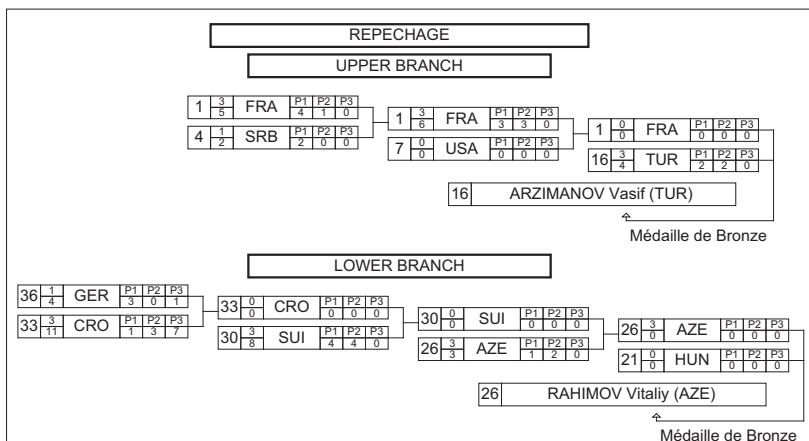



Classement

Senior World Championships



STYLE : GR 66 kg

1 - Or / Gold



VACHADZE Ambako

2 - Argent / Silver



VARDANYAN Armen

3 - Bronze



ARZIMANOV Vasif



RAHIMOV Vitaliy

| Classement | Nom - Name | Pays - Country |
|------------|-----------------------------|----------------|
| 1 | VACHADZE Ambako | RUS |
| 2 | VARDANYAN Armen | UKR |
| 3 | ARZIMANOV Vasif | TUR |
| 3 | RAHIMOV Vitaliy | AZE |
| 5 | GUENOT S. | FRA |
| 5 | LŐRINCZ Tamás | HUN |
| 7 | STREBEL Pascal | SUI |
| 8 | KIM Hyeon-Woo | KOR |
| 9 | JANECIC Danijel | CRO |
| 10 | EMILIYAN Todorov | BUL |
| 11 | SAHIN Faruk | USA |
| 12 | BAYAKHMETOV Darkhan | KAZ |
| 13 | MAKSIMOVIC Aleksandar | SRB |
| 14 | ABDVALI Saeid Morad | IRI |
| 15 | ADIKYAN Arman | ARM |
| 16 | PANAIT Ion Iulian | ROU |
| 17 | VALIMAKI Tero Seppo | FIN |
| 18 | KILOU Kazbek | BLR |
| 19 | POGUDIN Vladimir | UZB |
| 20 | FUJIMURA Tsutomu | JPN |
| 21 | GAIVAN Tudor | MDA |
| 22 | FETZER Christian | GER |
| 23 | TSKHADAIA Manuchar | GEO |
| 24 | BEGALIEV Kanatbek | KGZ |
| 25 | THOMMESEN Marius Blomstadli | NOR |
| 25 | SWIERK Tomasz | POL |
| 27 | WANG Hu | CHN |
| 28 | SUNIL Kumar | IND |
| 29 | PAROTSIDIS Loannis | GRE |
| 30 | SERIR Mohamed | ALG |
| 30 | JOSEPH Lopez | GUM |



Classement

Senior World Championships

STYLE : GR 66 kg



WORLD WRESTLING
CHAMPIONSHIP

| <i>Classement</i> | <i>Nom - Name</i> | <i>Pays - Country</i> |
|-------------------|----------------------------------|-----------------------|
| 32 | KADYROV Yazgeldy | TKM |
| 33 | VARDANYAN Sharur | SWE |
| 34 | NAVARRO SANCHEZ Ismael | ESP |
| 35 | PASSOS Hugo | POR |
| 36 | HUBERMAN GUERRERO Zairo Lisandro | CHI |



Feuille de compétition / Competition Sheet

Senior World Championships

STYLE : GR 74 kg



Classement

| Cl | Pays | Nom |
|----|------|-------------------------------|
| 1 | TUR | CEBI Selcuk |
| 2 | ARM | JULFALAKYAN Arsen |
| 3 | RUS | SHARAFETDINOV Imil |
| 3 | KGZ | KOBO NOV Daniyar |
| 5 | AZE | HUSEYNOV Rafiq |
| 5 | JPN | KANAKUBO Takehiro |
| 7 | KAZ | MELYOSHIN Roman |
| 8 | CRO | ZUGAJ Neven |
| 9 | SLO | KUHAR Jure |
| 10 | FRA | GUENOT Christophe René Marcel |
| 11 | UKR | PYSHKOV Dmytro |
| 12 | LTU | KAZAKEVIC Aleksandr |
| 13 | CHN | WANG Bingxuan |
| 14 | GEO | KVIRKELIA Manuchar |
| 15 | GER | SCHNEIDER Konstantin |
| 16 | UZB | MURODOV Azizbek |
| 17 | KOR | PARK Jin-Sung |
| 18 | CZE | SOBECKY Tomas |
| 19 | LAT | VISNAKOV'S Aleksandrs |
| 20 | HUN | BÁCSI Péter |

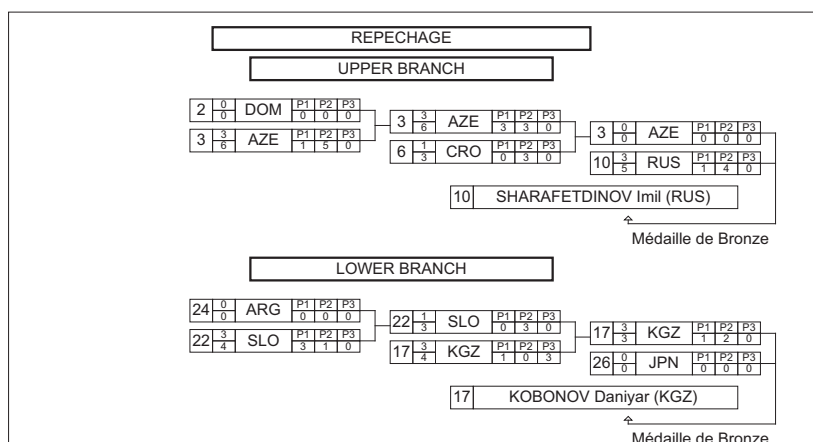



Classement

Senior World Championships

STYLE : GR 74 kg



WORLD WRESTLING
MOSCOW 18-22 SEPTEMBER 2002
CHAMPIONSHIP

1 - Or / Gold



CEBI Selcuk

2 - Argent / Silver



JULFALAKYAN Arsen

3 - Bronze



SHARAFETDINOV Imil



KOBONOV Daniyar

| Classement | Nom - Name | Pays - Country |
|------------|-------------------------------|----------------|
| 1 | CEBI Selcuk | TUR |
| 2 | JULFALAKYAN Arsen | ARM |
| 3 | SHARAFETDINOV Imil | RUS |
| 3 | KOBONOV Daniyar | KGZ |
| 5 | HUSEYNOV Rafig | AZE |
| 5 | KANAKUBO Takehiro | JPN |
| 7 | MELYOSHIN Roman | KAZ |
| 8 | ZUGAJ Neven | CRO |
| 9 | KUHAR Jure | SLO |
| 10 | GUENOT Christophe René Marcel | FRA |
| 11 | PYSHKOV Dmytro | UKR |
| 12 | KAZAKEVIC Aleksandr | LTU |
| 13 | WANG Bingxuan | CHN |
| 14 | KVIRKELIA Manuchar | GEO |
| 15 | SCHNEIDER Konstantin | GER |
| 16 | MURODOV Azizbek | UZB |
| 17 | PARK Jin-Sung | KOR |
| 18 | SOBECKY Tomas | CZE |
| 19 | VISNAKOV Aleksandrs | LAT |
| 20 | BÁCSI Péter | HUN |
| 21 | MOISIO Valtteri mikael | FIN |
| 22 | KIKINIOU Aliaksandr | BLR |
| 23 | FISHER Jacob | USA |
| 23 | MOHAMMADI Mehdi Rahman | IRI |
| 23 | ROSENGREN Robert Patrik | SWE |
| 23 | SHAHSAVAN Hassan | AUS |
| 23 | SHAFRAN Ilya | ISR |
| 23 | CONSUEGRA PANFE Mayli Raul | CUB |
| 29 | MANOUILIDIS Petros | GRE |
| 30 | KWIT Julian | POL |

**Classement****Senior World Championships**

STYLE : GR 74 kg

WORLD WRESTLING
CHAMPIONSHIP

| <i>Classement</i> | <i>Nom - Name</i> | <i>Pays - Country</i> |
|-------------------|----------------------------|-----------------------|
| 31 | BOUALEM Aziz | MAR |
| 31 | KATEA UERESI Tebitara | SOL |
| 33 | LLIYAN Todorov | BUL |
| 34 | GRAHAM Keitani Christopher | FSM |
| 35 | SCARAMUZZI Saverio | ITA |
| 36 | MOTA BREA Anyelo Alberto | DOM |
| 37 | ADDINALL Richard Brian | RSA |
| 37 | SUPPIGER Thomas | SUI |
| 39 | BARRIO Francisco Albano | ARG |



Feuille de compétition / Competition Sheet

Senior World Championships

STYLE : GR 84 kg



Classement

| Cl | Pays | Nom |
|----|------|--------------------------------|
| 1 | BUL | MARINOV Hristo Diyanov |
| 2 | CUB | SHOREY HERNANDEZ Pablo Enrique |
| 3 | RUS | MISHIN Aleksey |
| 3 | CRO | ZUGAJ Nenad |
| 5 | TUR | AVLUCA Nazmi |
| 5 | POL | JANIKOWSKI Damian |
| 7 | KAZ | OZDIYEV Alkhazur |
| 8 | GEO | GEGESHIDZE Vladimir |
| 9 | UKR | RACHYBA Vasyl |
| 10 | LTU | LAIMUTIS Adomaitis |
| 11 | USA | CLARK Jacob Adam |
| 12 | AUT | HRUSTANOVIC Amer |
| 13 | SRB | BALO Petar |
| 14 | ISR | NICKOLAEV Denis |
| 15 | UZB | MUMINOV Jakhongir |
| 16 | GER | FISCHER Jan |
| 17 | GRE | TOUNOUSIDIS Theodoros |
| 18 | TKM | ESENOV Ilyas |
| 19 | AZE | TAHMASIBI Saman |
| 20 | JPN | SAIKAWA Norikatsu |

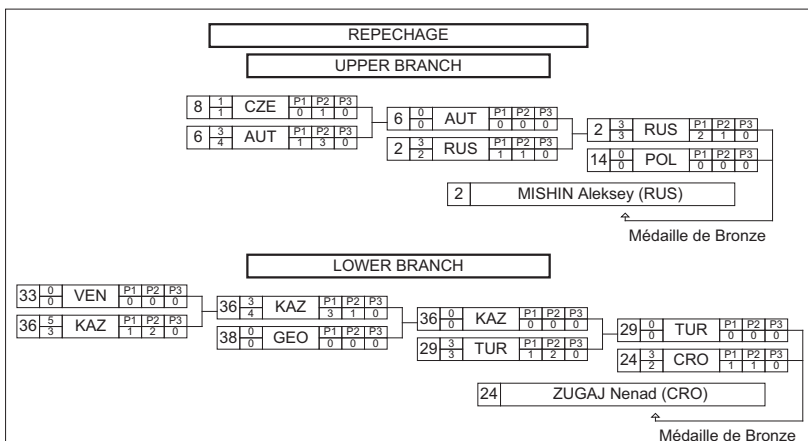



Classement

Senior World Championships



STYLE : GR 84 kg

1 - Or / Gold



MARINOV Hristo Diyanov

2 - Argent / Silver



SHOREY HERNANDEZ Pablo Enrique

3 - Bronze



MISHIN Aleksey



ZUGAJ Nenad

| Classement | Nom - Name | Pays - Country |
|------------|------------------------|----------------|
| 1 | MARINOV H. | BUL |
| 2 | SHOREY HERNANDEZ P. | CUB |
| 3 | MISHIN Aleksey | RUS |
| 3 | ZUGAJ Nenad | CRO |
| 5 | JANIKOWSKI Damian | POL |
| 5 | AVLUCA Nazmi | TUR |
| 7 | OZDIYEV Alkhazur | KAZ |
| 8 | GEGESHIDZE Vladimer | GEO |
| 9 | RACHYBA Vasyl | UKR |
| 10 | LAIMUTIS Adomaitis | LTU |
| 11 | CLARK Jacob Adam | USA |
| 12 | HRUSTANOVIC Amer | AUT |
| 13 | BALO Petar | SRB |
| 14 | NICKOLAEV Denis | ISR |
| 15 | MUMINOV Jakhongir | UZB |
| 16 | FISCHER Jan | GER |
| 17 | TOUNOUSIDIS Theodoros | GRE |
| 18 | ESENOV Ylyas | TKM |
| 19 | TAHMASIBI Saman | AZE |
| 20 | SAIKAWA Norikatsu | JPN |
| 21 | OMAROV Artur | CZE |
| 22 | APS Eerik | EST |
| 23 | HRABOVIK Aliaksandr | BLR |
| 24 | NOUMONVI Mélonin | FRA |
| 24 | HIETANIEMI Rami Antero | FIN |
| 26 | SERNEK Dejan | SLO |
| 27 | BARTOLOZZY Edy | VEN |
| 28 | MOCANU Andrian | MDA |
| 29 | FOROV Denis | ARM |
| 30 | LEE Se-Yeol | KOR |

**Classement****Senior World Championships**

STYLE : GR 84 kg

WORLD WRESTLING
CHAMPIONSHIP

| <i>Classement</i> | <i>Nom - Name</i> | <i>Pays - Country</i> |
|-------------------|---------------------------------|-----------------------|
| 31 | NEMATPOUR Taleb Nariman | IRI |
| 32 | DAJKA Zsolt | HUN |
| 32 | ACHOURI Haikel | TUN |
| 32 | KARACHOLOKOV Ulukbek | KGZ |
| 35 | DUAN Ning | CHN |
| 35 | LJUNGBACK Benni Christoffer | SWE |
| 35 | MIHALIK Marian | SVK |
| 35 | MOSQUERA Christian | COL |
| 39 | LIN Ming-Hsuan | TPE |
| 40 | ESTRADA ROMBILD Domingo Antonio | NCA |



Feuille de compétition / Competition Sheet

Senior World Championships

STYLE : GR 96 kg



Classement

| Cl | Pays | Nom |
|----|------|-----------------------------|
| 1 | IRI | ALIAKBARI Amir Aziz |
| 2 | BLR | DZEINICHENKA Tsimafei |
| 3 | RUS | KHUSHTOV Aslanbek |
| 3 | SWE | LIDBERG Jimmy Alexander |
| 5 | UZB | SALDADZE David |
| 5 | USA | RUIZ Justin Daniel |
| 7 | CUB | ESTRADA FALCON Yunior |
| 8 | ITA | TIMONCINI Daigoro |
| 9 | ROU | PAPP Robert Alexandru |
| 10 | BUL | DINCHEV Kaloyan Ivanov |
| 11 | GER | ENGLISH Mirko |
| 12 | POL | MALINOWSKI Przemyslaw |
| 13 | UKR | KRYOKA Oleg |
| 14 | TUR | TACYILDIZ Ahmet |
| 15 | KAZ | MAMBETOV Asset |
| 16 | CZE | VALA David |
| 17 | EGY | ABDELFAHAT Mohammed Ibrahim |
| 18 | KOR | AN Chang-Gun |
| 19 | ARM | TONOYAN Sargis |
| 20 | HUN | NÉMETH Iván |

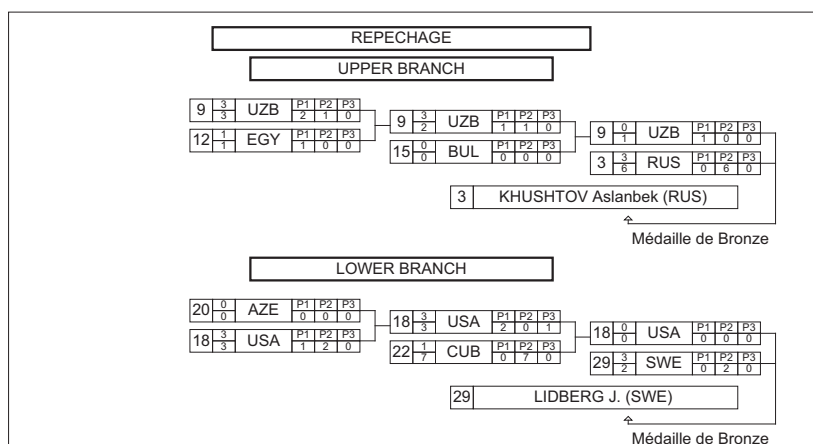



Classement

Senior World Championships

STYLE : GR 96 kg



WORLD WRESTLING
FEDERATION
CHAMPIONSHIP

1 - Or / Gold



ALIAKBARI Amir Aziz

2 - Argent / Silver



DZEINICHENKA Tsimafei

3 - Bronze



KHUSHTOV Aslanbek



LIDBERG Jimmy Alexander

| Classement | Nom - Name | Pays - Country |
|------------|-----------------------------|----------------|
| 1 | ALIAKBARI Amir Aziz | IRI |
| 2 | DZEINICHENKA T. | BLR |
| 3 | KHUSHTOV Aslanbek | RUS |
| 3 | LIDBERG J. | SWE |
| 5 | SALDADZE David | UZB |
| 5 | RUIZ Justin Daniel | USA |
| 7 | ESTRADA FALCON Yunior | CUB |
| 8 | TIMONCINI Daigoro | ITA |
| 9 | PAPP Robert Alexandru | ROU |
| 10 | DINCHEV Kaloyan Ivanov | BUL |
| 11 | ENGLICH Mirko | GER |
| 12 | MALINOWSKI Przemyslaw | POL |
| 13 | KRYOKA Oleg | UKR |
| 14 | TACYILDIZ Ahmet | TUR |
| 15 | MAMBETOV Asset | KAZ |
| 16 | VALA David | CZE |
| 17 | ABDELFATAH Mohammed Ibrahim | EGY |
| 18 | AN Chang-Gun | KOR |
| 19 | TONOYAN Sargis | ARM |
| 20 | NÉMETH Iván | HUN |
| 20 | KITAMURA Katsuya | JPN |
| 22 | YAHIA Mohammad | JOR |
| 22 | JABIDZE Soso | GEO |
| 24 | HOGAC Sinisa | CRO |
| 24 | HÖRMANN Lukas | AUT |
| 26 | FKIRI Hassene Ben Amara | AUS |
| 26 | KARELSON Richard | EST |
| 28 | KOSZEGHY Filip | SVK |
| 29 | SCARCI Cristian | SMR |
| 29 | HUMBATOV Sabuhi | AZE |
| 29 | HOU Zhenlin | CHN |



Classement

Senior World Championships

STYLE : GR 96 kg



| <i>Classement</i> | <i>Nom - Name</i> | <i>Pays - Country</i> |
|-------------------|--------------------------|-----------------------|
| 32 | CAZAC Marin | MDA |
| 32 | LUKOSAITIS Aldas | LTU |
| 34 | BELLA-LUFU Kakoma Hugues | RSA |



Classement

Senior World Championships



STYLE : GR 120 kg

1 - Or / Gold



LOPEZ NUNEZ Mijain

2 - Argent / Silver



PATRIKEEV Yuri

3 - Bronze



TINALIYEV Nurmakhan



KAYAALP Riza

| Classement | Nom - Name | Pays - Country |
|------------|------------------------------|----------------|
| 1 | LOPEZ NUNEZ Mijain | CUB |
| 2 | PATRIKEEV Yuri | ARM |
| 3 | TINALIYEV Nurmakhan | KAZ |
| 3 | KAYAALP Riza | TUR |
| 5 | SVEC Marek | CZE |
| 5 | BYERS D. | USA |
| 7 | BAROEV Khasan | RUS |
| 8 | BANAK Lukasz | POL |
| 9 | EUREN Johan Magnus | SWE |
| 10 | PERSELIDZE Guram | GEO |
| 11 | GURALSKI Vladimir | ISR |
| 12 | CHERNETSKYY Oleksandr | UKR |
| 13 | CHUGOSHVILI Ioseb | BLR |
| 14 | NABI Heiki | EST |
| 15 | RAMONOV Murat | KGZ |
| 16 | LALLI Taisto henrik | FIN |
| 17 | MIZGAITIS Mindaugas | LTU |
| 18 | DEÁK-BÁRDOS Mihály | HUN |
| 18 | TUYCHIEV Murodjon | TJK |
| 18 | MEHRALIYEV Zaur | AZE |
| 18 | SPASIC Milos | SRB |
| 18 | POPOV Ivan | AUS |
| 18 | FARNIEV Soslan | UZB |
| 24 | GHOORBANI GOLDASTEH Mohammad | IRI |
| 24 | SZCZEPANIAK Yannick | FRA |
| 26 | SHINJO Hirokazu | JPN |
| 27 | BOEHRINGER Ralf Walter | GER |
| 28 | DALAL Dharmender | IND |
| 29 | HANI Salah | JOR |
| 30 | FICARA Rocco Daniele | ITA |
| 30 | NIE Xiaoming | CHN |



Classement

Senior World Championships

STYLE : GR 120 kg



| <i>Classement</i> | <i>Nom - Name</i> | <i>Pays - Country</i> |
|-------------------|-------------------|-----------------------|
|-------------------|-------------------|-----------------------|

