



**13 INTERNATIONAL WRESTLING TOURNAMENT, JUNIORS**  
**FREE STYLE & GRECO-ROMAN STYLE**  
**"PETKO SIRAKOV - IVAN ILIEV"**  
**20-21.03.2010, SOFIA, BULGARIA**

---

**FILA DELEGATE: Machaidze Edisher - GEO**  
**CHIEF REFEREE: Antov Petar - BUL**

**JURY D'APPEL :**

1	Machaidze Edisher	GEO	Ol.
2	Antov Petar	BUL	Ol.

**MAT "A"**

**MAT "B"**

**MAT "C"**

1 Miroslav Gotchev	BUL	I	3 Hossein Sayed	IRI	II	5 Vigier Georges	FRA	II
2 Krachium Joan	ROM	II	8 Ludmil Kirilov	BUL	II	6 Ivan Vichev	BUL	I
7 Ivan Kostadinov	BUL	II	4 Dursun Parlak	TUR	II	11 Angelov Angel Ilkov	BUL	II
21 Lubcho Janev	MKD	II	10 Valentin Guetsov	BUL	II	24 Chamishki Denislav	BUL	II
9 Nasser Varzandeh	IRI	II	13 Mohamed Meddah	ALG	II	14 Alexandros Anastasiadis	GRE	III
12 Valeri Raichev	BUL	III	16 Yerzhan Jambubayev	KAZ	III	17 Massimo Stoponi	ITA	III
15 Bajrektarevic Elvis	CRO	III	19 Moss James	USA	III	20 Marianko Lazarov	MKD	III
18 Korba Stefan	SVK	III	22 Semen Cherdonov	RUS	III	23 Janos Kismoni	HUN	III
25 Afanssiev Andrei	ISR	III						



# INTERNATIONAL WRESTLING TOURNAMENT - JUNIORS FS

“PETKO SIRAKOV- IVAN ILIEV, 20-21.03.2010, SOFIA

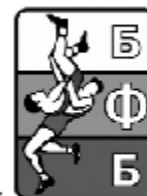

	50	55	60	66	74	84	96	120	Grand Total
ALG	1			2					3
BUL	3	3	4	6	4	4	2	3	29
FRA	1	1	1	1	1	1	1		7
GRE			1	1	2	2			6
HUN	1	1	1	1	2	1	2	1	10
IRI	1	1	1	2	1	2	1	1	10
ISR		1				1		1	3
KAZ	1	2	2	2		2	1	1	11
MKD	1		2	1	1	1			6
ROU	1	1	1	2	2		1	1	9
RUS	2	2	2						6
SVK			1	1	2			1	5
TUR	3	2	2	1	2	2	2	2	16
USA		1							1
<b>Grand Total</b>	<b>15</b>	<b>15</b>	<b>18</b>	<b>20</b>	<b>17</b>	<b>16</b>	<b>10</b>	<b>11</b>	<b>122</b>



**13 INTERNATIONAL WRESTLING TOURNAMENT, JUNIORS  
FREE STYLE & GRECO-ROMAN STYLE  
"PETKO SIRAKOV - IVAN ILIEV"  
20-21.03.2010, SOFIA, BULGARIA**

**MEDALIST - FREE STYLE**

**cat. 50 kg**

1	Foladvand Abdollah	IRI
2	Primbayev Berdakh	KAZ
3	Ivaylo Arnaudov	BUL
3	Zyryanov Makar	RUS

**cat. 55 kg**

1	Kaliyev Rassul	KAZ
2	Tolepbay Gabit	KAZ
3	Molnar Jozef	HUN
3	Vedat Bulduk	TUR

**cat. 60 kg**

1	Nasiriafrachali Mehran	IRI
2	Okassov Sayatbek	KAZ
3	Vasilyev Dulustan	RUS
3	Abdi Zurnaci	TUR

**cat. 66 kg**

1	Servet Coskun	TUR
2	Yeganehjafari Mohammad	IRI
3	Olle Robert	SVK
3	Yousefi Mohammad	IRI

**cat. 74 kg**

1	Rezaei Ghaleh Morteza	IRI
2	Teodor Stoev	BUL
3	Manea Michael	ROU
3	Soner Demirtas	TUR

**cat. 84 kg**

1	Ibrahim Bolukbasi	TUR
2	Xenidis Timofei	GRE
3	Mohammad Amir	IRI
3	Azizov Islam	KAZ

**cat. 96 kg**

1	Kasim Sarac	TUR
2	Fatih Yasarli	TUR
3	Kazamiaghamashhadi	IRI
3	Turculeanu Mihai	ROU

**cat. 120 kg**

1	Taha Akgul	TUR
2	Yalycin Sozen	TUR
3	Csercsics Richard	HUN
3	Daniel Yankov	BUL

***The best international wrestler FS - Servet Coskun, cat. 66 kg, TUR***

# INTERNATIONAL WRESTLING TOURNAMENT -JUNIORS "PETKO SIRAKOV-IVAN ILIEV", 20-21.03.2010, SOFIA

1	Pays	Foladvand Abdollah	3	P1	P2	P3
	IRI		5	3	2	0
2	Pays	Zyryanov Makar	1	P1	P2	P3
	RUS		1	1	0	0
5	Pays	Sandor Csaba	5	P1	P2	P3
	ROU		7	1	6	0
6	Pays	Elovaraque Zoheir	0	P1	P2	P3
	FRA		0	0	0	0
9	Pays	Primbayev Berdakh	3	P1	P2	P3
	KAZ		9	3	6	0
11	Pays	Prokhorov Alexander	0	P1	P2	P3
	RUS		0	0	0	0
13	Pays	Ivaylo Arnaudov	3	P1	P2	P3
	BUL		6	0	5	1
15	Pays	Burhan Atintas	1	P1	P2	P3
	TUR		7	4	3	0

1	Pays	5	P1	P2	P3
	IRI	6	4	0	2
5	Pays	0	P1	P2	P3
	ROU	1	0	1	0
9	Pays	5	P1	P2	P3
	KAZ	6	3	3	0
13	Pays	0	P1	P2	P3
	BUL	0	0	0	0

1	Pays	3	P1	P2	P3
	IRI	14	6	0	8
9	Pays	1	P1	P2	P3
	KAZ	6	1	5	0

1	Pays	Foladvand Abdollah
	IRI	

CATEGORY **50**

STYLE **FS**

### REPECHAGE

#### Qualification round

2	Pays	Zyryanov Makar	4	P1	P2	P3
	RUS		13	7	6	0
3	Pays	Fisnik Dura	0	P1	P2	P3
	MKD		0	0	0	0
4	Pays	Zhan Stilianov	0	P1	P2	P3
	BUL		4	0	4	0
5	Pays	Sandor Csaba	5	P1	P2	P3
	ROU		9	2	7	0
6	Pays	Elovaraque Zoheir	3	P1	P2	P3
	FRA		4	3	1	0
7	Pays	Kolio Kolev	1	P1	P2	P3
	BUL		2	2	0	0
8	Pays	Soner Bulak	0	P1	P2	P3
	TUR		0	0	0	0
9	Pays	Primbayev Berdakh	4	P1	P2	P3
	KAZ		13	6	7	0
10	Pays	Benkraouche Abdelmoumen	1	P1	P2	P3
	ALG		1	0	1	0
11	Pays	Prokhorov Alexander	3	P1	P2	P3
	RUS		4	2	2	0
12	Pays	Molnar Robert	1	P1	P2	P3
	HUN		2	0	2	0
13	Pays	Ivaylo Arnaudov	3	P1	P2	P3
	BUL		3	1	2	0
14	Pays	Nebi Uzun	1	P1	P2	P3
	TUR		9	5	0	4
15	Pays	Burhan Atintas	3	P1	P2	P3
	TUR		7	1	1	5

8	Pays	0	P1	P2	P3
	TUR	0	0	0	0
11	Pays	3	P1	P2	P3
	RUS	7	2	5	0
	Pays				
	Pays				

#### LOWER BRANCH

2	Pays	3	P1	P2	P3
	RUS	5	2	3	0
5	Pays	0	P1	P2	P3
	ROU	0	0	0	0

2	Pays	Zyryanov Makar
	RUS	

#### UPPER BRANCH

11	Pays	1	P1	P2	P3
	RUS	1	0	1	0
13		3	P1	P2	P3
	BUL	3	2	1	0

13	Pays	Ivaylo Arnaudov
	BUL	



**INTERNATIONAL WRESTLING  
TOURNAMENT - JUNIORS FS**  
"PETKO SIRAKOV- IVAN ILIEV, 20-21.03.2010, SOFIA

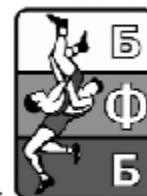

Category 50

Rank	No	Name	Country	C.P	Falls	E.M.	E.R	Win Points	Lost Points
1	1	Foladvand Abdollah	IRI	11	0	0	1	25	8
2	9	Primbayev Berdakh	KAZ	13	0	1	3	34	14
3	13	Ivaylo Arnaudov	BUL	9	0	0	0	12	16
3	2	Zyryanov Makar	RUS	8	0	1	2	19	5
5	5	Sandor Csaba	ROU	10	1	0	1	17	15
5	11	Prokhorov Alexander	RUS	7	0	0	0	12	13
7	15	Burhan Atlintas	TUR	4	0	0	0	14	15
8	6	Elovaraque Zoheir	FRA	3	0	0	0	4	9
9	14	Nebi Uzun	TUR	1	0	0	0	9	7
10	12	Molnar Robert	HUN	1	0	0	0	2	3
11	7	Kolio Kolev	BUL	1	0	0	0	2	4
12	10	Benkraouche Abdelmoumen	ALG	1	0	0	0	1	4
13	4	Zhan Stilianov	BUL	0	0	0	0	4	9
14	3	Fisnik Dura	MKD	0	0	0	0	0	13
15	8	Soner Bulak	TUR	0	0	0	0	0	20

# INTERNATIONAL WRESTLING TOURNAMENT -JUNIORS

## "PETKO SIRAKOV-IVAN ILIEV", 20-21.03.2010, SOFIA

1	Pays	Mishel Mihaylov	0	P1	P2	P3
	BUL		0	0	0	0
2	Pays	Molnar Jozef	5	P1	P2	P3
	HUN		9	6	3	0
5	Pays	Ansari Chakir	0	P1	P2	P3
	FRA		0	0	0	0
6	Pays	Tolepbay Gabit	3	P1	P2	P3
	KAZ		12	5	7	0
9	Pays	Kaliyev Rassul	3	P1	P2	P3
	KAZ		5	0	1	4
10	Pays	Karimizad Hemmat	1	P1	P2	P3
	IRI		6	6	0	0
12	Pays	Mikhaylov Aytal	0	P1	P2	P3
	RUS		2	0	2	0
15	Pays	Vedat Bulduk	3	P1	P2	P3
	TUR		4	1	3	0

### Qualification round

2	Pays	Molnar Jozef	3	P1	P2	P3
	HUN		9	7	2	0
3	Pays	Naiden Ivanov	0	P1	P2	P3
	BUL		0	0	0	0
4	Pays	Biniashvili David	0	P1	P2	P3
	ISR		10	9	1	0
5	Pays	Ansari Chakir	5	P1	P2	P3
	FRA		13	4	6	3
6	Pays	Tolepbay Gabit	3	P1	P2	P3
	KAZ		7	1	6	0
7	Pays	Krum Chuchurov	0	P1	P2	P3
	BUL		0	0	0	0
8	Pays	Max Nowry	0	P1	P2	P3
	USA		0	0	0	0
9	Pays	Kaliyev Rassul	4	P1	P2	P3
	KAZ		12	6	6	0
10	Pays	Karimizad Hemmat	3	P1	P2	P3
	IRI		9	2	7	0
11	Pays	Berati Oztop	0	P1	P2	P3
	TUR		0	0	0	0
12	Pays	Mikhaylov Aytal	3	P1	P2	P3
	RUS		10	3	7	0
13	Pays	Donu Raul	1	P1	P2	P3
	ROU		3	2	1	0
14	Pays	Iakovlev Vladimir	1	P1	P2	P3
	RUS		8	3	4	1
15	Pays	Vedat Bulduk	3	P1	P2	P3
	TUR		9	4	2	3

2	Pays	1	P1	P2	P3
	HUN	1	0	1	0
6	Pays	0	P1	P2	P3
	KAZ	1	1	0	0
6	Pays	3	P1	P2	P3
	KAZ	5	2	3	0
9	Pays	3	P1	P2	P3
	KAZ	4	2	2	0
9	Pays	5	P1	P2	P3
	KAZ	4	1	3	0
15	Pays	0	P1	P2	P3
	TUR	0	0	0	0

CATEGORY **55**

STYLE **FS**

9	Pays	Kaliyev Rassul
	KAZ	

### REPECHAGE LOWER BRANCH

8	Pays	0	P1	P2	P3
	USA	1	0	1	0
10	Pays	1	P1	P2	P3
	IRI	4	1	3	0
10	Pays	3	P1	P2	P3
	IRI	4	1	3	0
15	Pays	3	P1	P2	P3
	TUR	12	4	8	0

15	Pays	Vedat Bulduk
	TUR	

### UPPER BRANCH

7	Pays	5	P1	P2	P3
	BUL	7	3	4	0
7	Pays	0	P1	P2	P3
	BUL	0	0	0	0
5	Pays	0	P1	P2	P3
	FRA	1	1	0	0
2	Pays	5	P1	P2	P3
	HUN	0	0	0	0

2	Pays	Molnar Jozef
	HUN	



**INTERNATIONAL WRESTLING  
TOURNAMENT - JUNIORS FS**  
"PETKO SIRAKOV- IVAN ILIEV, 20-21.03.2010, SOFIA

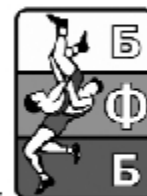

Category 55

Rank	No	Name	Country	C.P	Falls	E.M.	E.R	Win Points	Lost Points
1	9	Kaliyev Rassul	KAZ	15	0	1	2	25	7
2	6	Tolepbay Gabit	KAZ	9	0	0	2	25	5
3	15	Vedat Bulduk	TUR	9	0	0	0	25	18
3	2	Molnar Jozef	HUN	14	1	0	2	19	5
5	7	Krum Chuchurov	BUL	5	1	0	0	7	8
5	10	Karimizad Hemmat	IRI	8	0	0	2	23	18
7	5	Ansari Chakir	FRA	5	1	0	0	14	29
8	12	Mikhaylov Aytal	RUS	3	0	0	1	12	7
9	14	Iakovlev Vladimir	RUS	1	0	0	0	8	9
10	13	Donu Raul	ROU	1	0	0	0	3	10
11	4	Biniashvili David	ISR	0	0	0	0	10	13
12	8	Max Nowry	USA	0	0	0	0	1	16
13	11	Berati Oztop	TUR	0	0	0	0	0	9
14	3	Naiden Ivanov	BUL	0	0	0	0	0	9
15	1	Mishel Mihaylov	BUL	0	0	0	0	0	9

# INTERNATIONAL WRESTLING TOURNAMENT -JUNIORS "PETKO SIRAKOV-IVAN ILIEV", 20-21.03.2010, SOFIA

CATEGORY **60**

STYLE **FS**

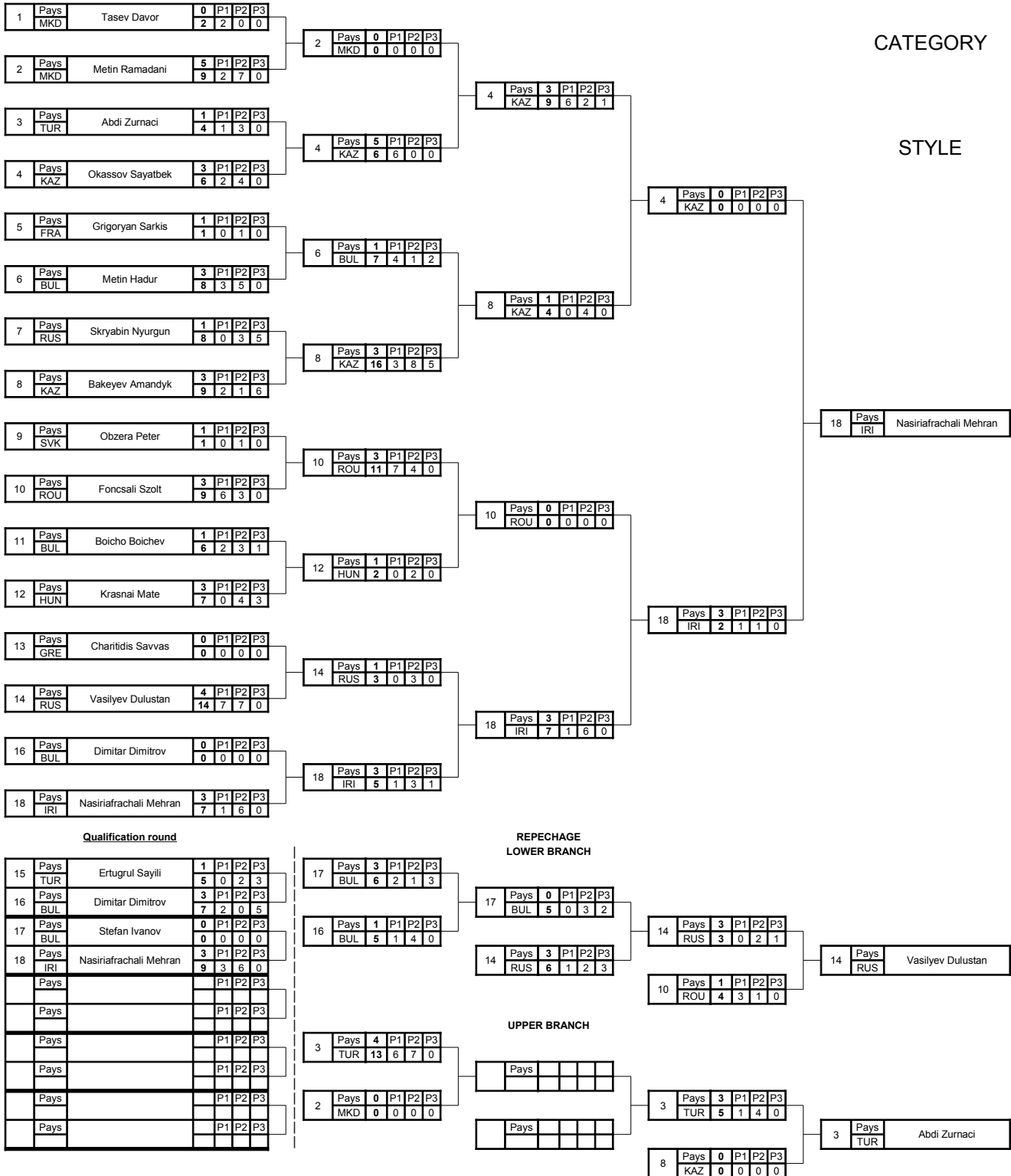





**INTERNATIONAL WRESTLING  
TOURNAMENT - JUNIORS FS**  
"PETKO SIRAKOV- IVAN ILIEV, 20-21.03.2010, SOFIA

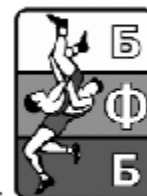

Category 60

Rank	No	Name	Country	C.P	Falls	E.M.	E.R	Win Points	Lost Points
1	18	Nasirifrachali Mehran	IRI	15	0	0	3	30	3
2	4	Okassov Sayatbek	KAZ	11	1	0	2	21	10
3	3	Abdi Zurnaci	TUR	8	0	1	2	22	6
3	14	Vasilyev Dulustan	RUS	11	0	1	2	26	14
5	10	Foncsali Szolt	ROU	7	0	0	2	24	13
5	8	Bakeyev Amandyk	KAZ	7	0	0	1	29	29
7	2	Metin Ramadani	MKD	5	1	0	1	9	21
8	6	Metin Hadur	BUL	4	0	0	0	15	17
9	16	Dimitar Dimitrov	BUL	4	0	0	0	12	18
10	12	Krasnai Mate	HUN	4	0	0	0	9	17
11	17	Stefan Ivanov	BUL	3	0	0	0	11	20
12	7	Skryabin Nyurgun	RUS	1	0	0	0	8	9
13	11	Boicho Boichev	BUL	1	0	0	0	6	7
14	15	Ertugrul Sayili	TUR	1	0	0	0	5	7
15	5	Grigoryan Sarkis	FRA	1	0	0	0	1	8
16	9	Obzera Peter	SVK	1	0	0	0	1	9
17	1	Tasev Davor	MKD	0	0	0	0	2	9
18	13	Charitidis Savvas	GRE	0	0	0	0	0	14

# INTERNATIONAL WRESTLING TOURNAMENT -JUNIORS "PETKO SIRAKOV-IVAN ILIEV", 20-21.03.2010, SOFIA

CATEGORY **66**

STYLE **FS**

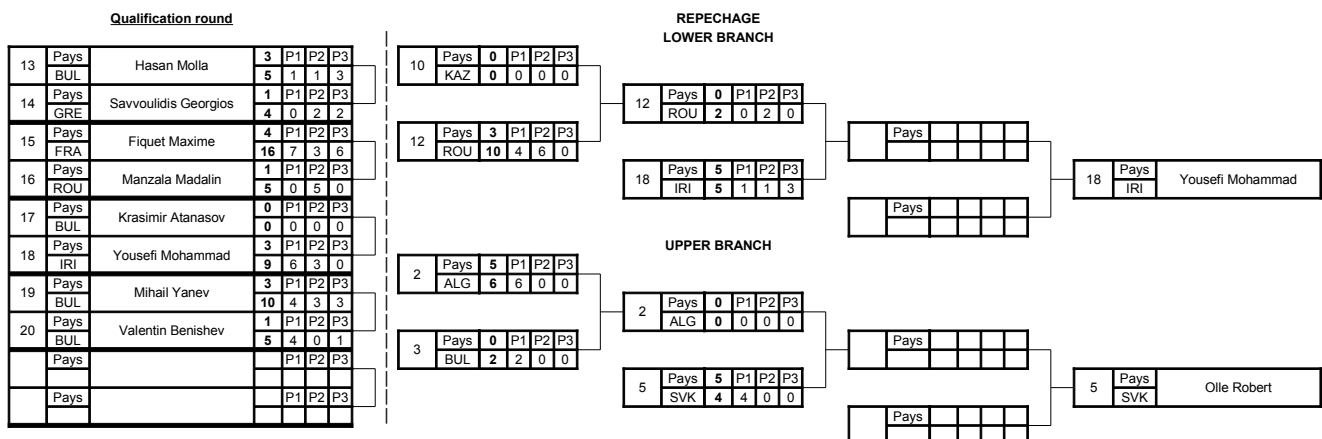
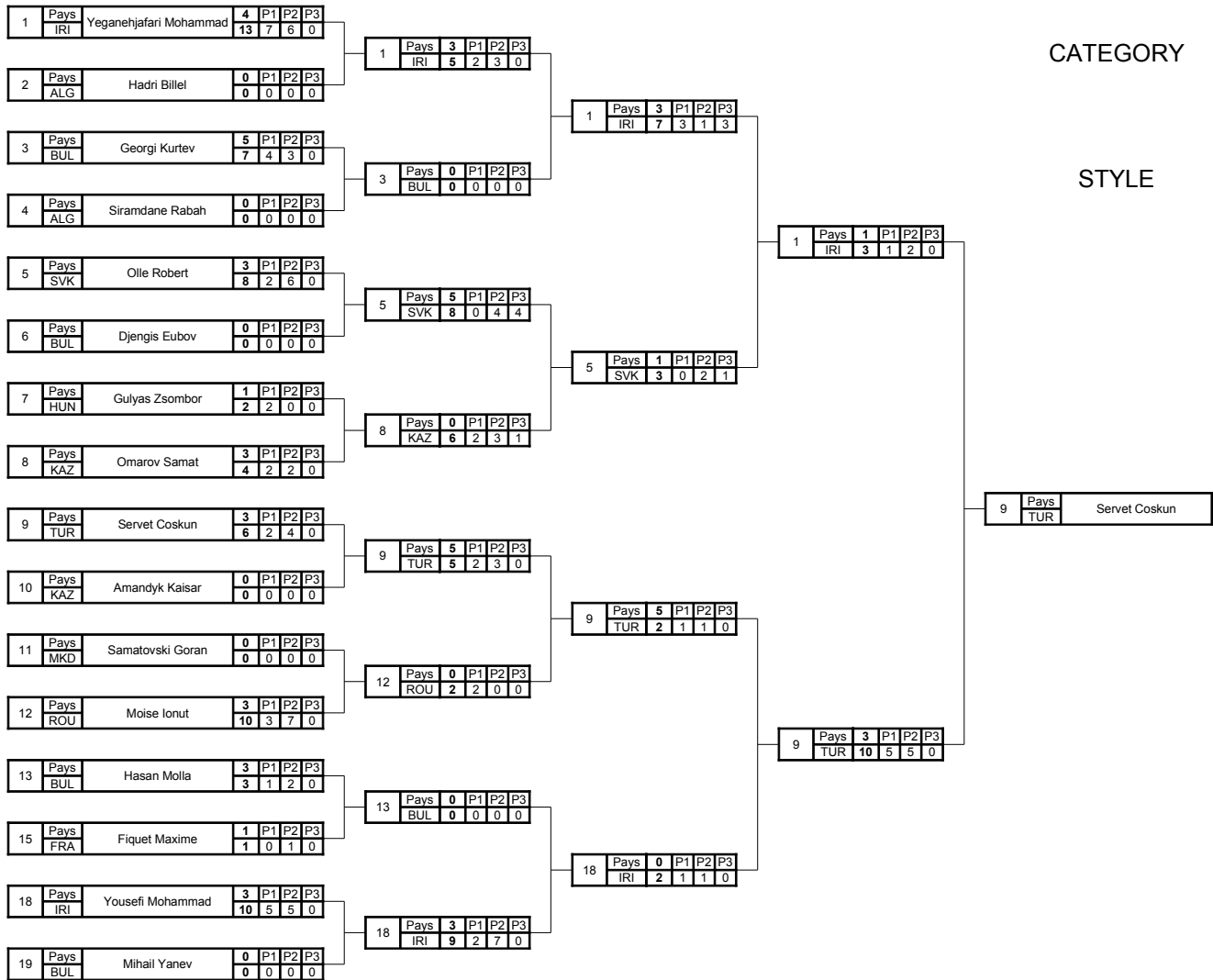



**INTERNATIONAL WRESTLING  
TOURNAMENT - JUNIORS FS**  
"PETKO SIRAKOV- IVAN ILIEV, 20-21.03.2010, SOFIA

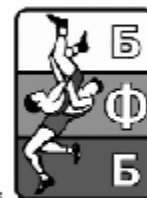

Category 66

Rank	No	Name	Country	C.P	Falls	E.M.	E.R	Win Points	Lost Points
1	9	Servet Coskun	TUR	16	1	0	0	23	7
2	1	Yeganehjafari Mohammad	IRI	11	0	1	2	28	13
3	5	Olle Robert	SVK	14	0	0	1	23	13
3	18	Yousefi Mohammad	IRI	14	1	0	2	35	4
5	2	Hadri Billel	ALG	5	1	0	0	6	19
5	12	Moise Ionut	ROU	6	0	0	2	24	10
7	13	Hasan Molla	BUL	6	0	0	0	8	14
8	15	Fiquet Maxime	FRA	5	0	1	2	17	8
9	3	Georgi Kurtev	BUL	5	0	0	0	9	11
10	8	Omarov Samat	KAZ	3	0	0	0	10	10
11	19	Mihail Yanev	BUL	3	0	0	0	10	15
12	20	Valentin Benishev	BUL	1	0	0	0	5	10
13	16	Manzala Madalin	ROU	1	0	0	0	5	16
14	14	Savvoulidis Georgios	GRE	1	0	0	0	4	5
15	7	Gulyas Zsombor	HUN	1	0	0	0	2	4
16	4	Siramdane Rabah	ALG	0	0	0	0	0	7
17	6	Djengis Eubov	BUL	0	0	0	0	0	8
18	17	Krasimir Atanasov	BUL	0	0	0	0	0	9
19	11	Samatovski Goran	MKD	0	0	0	0	0	10
20	10	Amandyk Kaiser	KAZ	0	0	0	0	0	16

# INTERNATIONAL WRESTLING TOURNAMENT -JUNIORS "PETKO SIRAKOV-IVAN ILIEV", 20-21.03.2010, SOFIA

CATEGORY **74**

STYLE **FS**

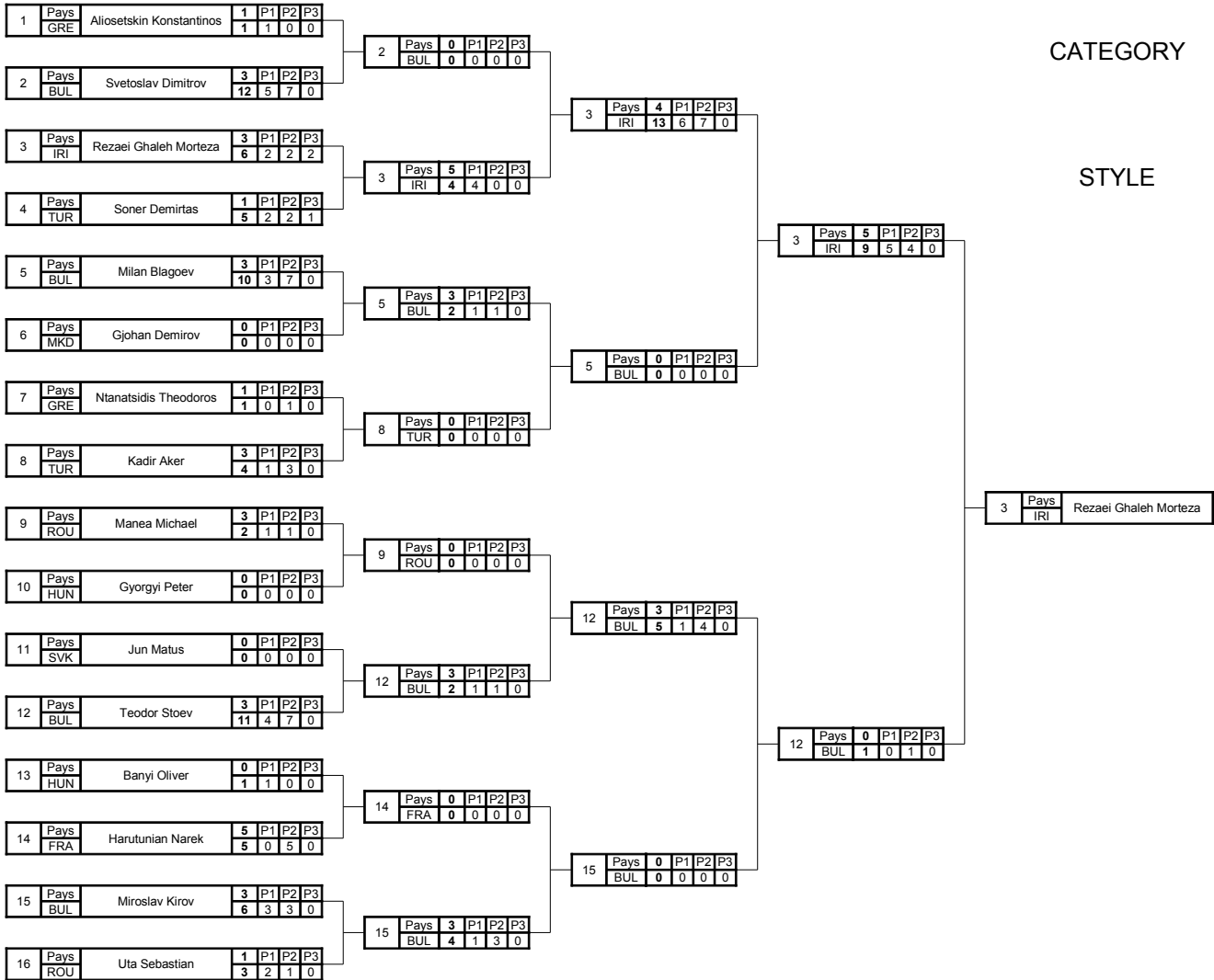

**Qualification round**

**REPECHAGE  
LOWER BRANCH**

**UPPER BRANCH**

16	Pays	ROU	Uta Sebastian	5	P1	P2	P3
				2	2	0	0
17	Pays	SVK	Deak Matej	0	P1	P2	P3
				0	0	0	0
	Pays				P1	P2	P3
	Pays				P1	P2	P3
	Pays				P1	P2	P3
	Pays				P1	P2	P3
	Pays				P1	P2	P3

11	Pays	SVK		0	P1	P2	P3
				0	0	0	0
9	Pays	ROU		3	P1	P2	P3
				8	2	6	0
4	Pays	TUR		3	P1	P2	P3
				9	1	1	7
2	Pays	BUL		1	P1	P2	P3
				2	2	0	0

9	Pays	ROU	Manea Michael	3	P1	P2	P3
				3	1	2	0

15	Pays	BUL		1	P1	P2	P3
				1	1	0	0

4	Pays	TUR	Soner Demirtas	5	P1	P2	P3
				6	1	5	0

5	Pays	BUL		0	P1	P2	P3
				1	1	0	0

9	Pays	ROU	Manea Michael	3	P1	P2	P3
				3	1	2	0

15	Pays	BUL		1	P1	P2	P3
				1	1	0	0

4	Pays	TUR	Soner Demirtas	5	P1	P2	P3
				6	1	5	0

4	Pays	TUR	Soner Demirtas	5	P1	P2	P3
				9	5	4	0



**INTERNATIONAL WRESTLING  
TOURNAMENT - JUNIORS FS**  
"PETKO SIRAKOV- IVAN ILIEV, 20-21.03.2010, SOFIA

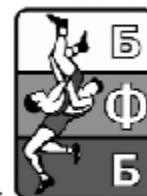

Category 74

Rank	No	Name	Country	C.P	Falls	E.M.	E.R	Win Points	Lost Points
1	3	Rezaei Ghaleh Morteza	IRI	17	1	1	2	32	6
2	12	Teodor Stoev	BUL	9	0	0	1	19	9
3	4	Soner Demirtas	TUR	9	0	0	1	20	9
3	9	Manea Michael	ROU	9	0	0	1	13	3
5	5	Milan Blagoev	BUL	6	0	0	1	13	19
5	15	Miroslav Kirov	BUL	7	0	0	0	11	11
7	16	Uta Sebastian	ROU	6	1	0	0	5	6
8	14	Harutunian Narek	FRA	5	1	0	0	5	5
9	2	Svetoslav Dimitrov	BUL	4	0	0	1	14	14
10	8	Kadir Aker	TUR	3	0	0	0	4	3
11	7	Ntanatsidis Theodoros	GRE	1	0	0	0	1	4
12	1	Aliosetskin Konstantinos	GRE	1	0	0	0	1	12
13	13	Banyi Oliver	HUN	0	0	0	0	1	5
14	10	Gyorgyi Peter	HUN	0	0	0	0	0	2
15	17	Deak Matej	SVK	0	0	0	0	0	2
16	6	Gjohan Demirov	MKD	0	0	0	0	0	10
17	11	Jun Matus	SVK	0	0	0	0	0	19

# INTERNATIONAL WRESTLING TOURNAMENT -JUNIORS "PETKO SIRAKOV-IVAN ILIEV", 20-21.03.2010, SOFIA

CATEGORY **84**

STYLE **FS**

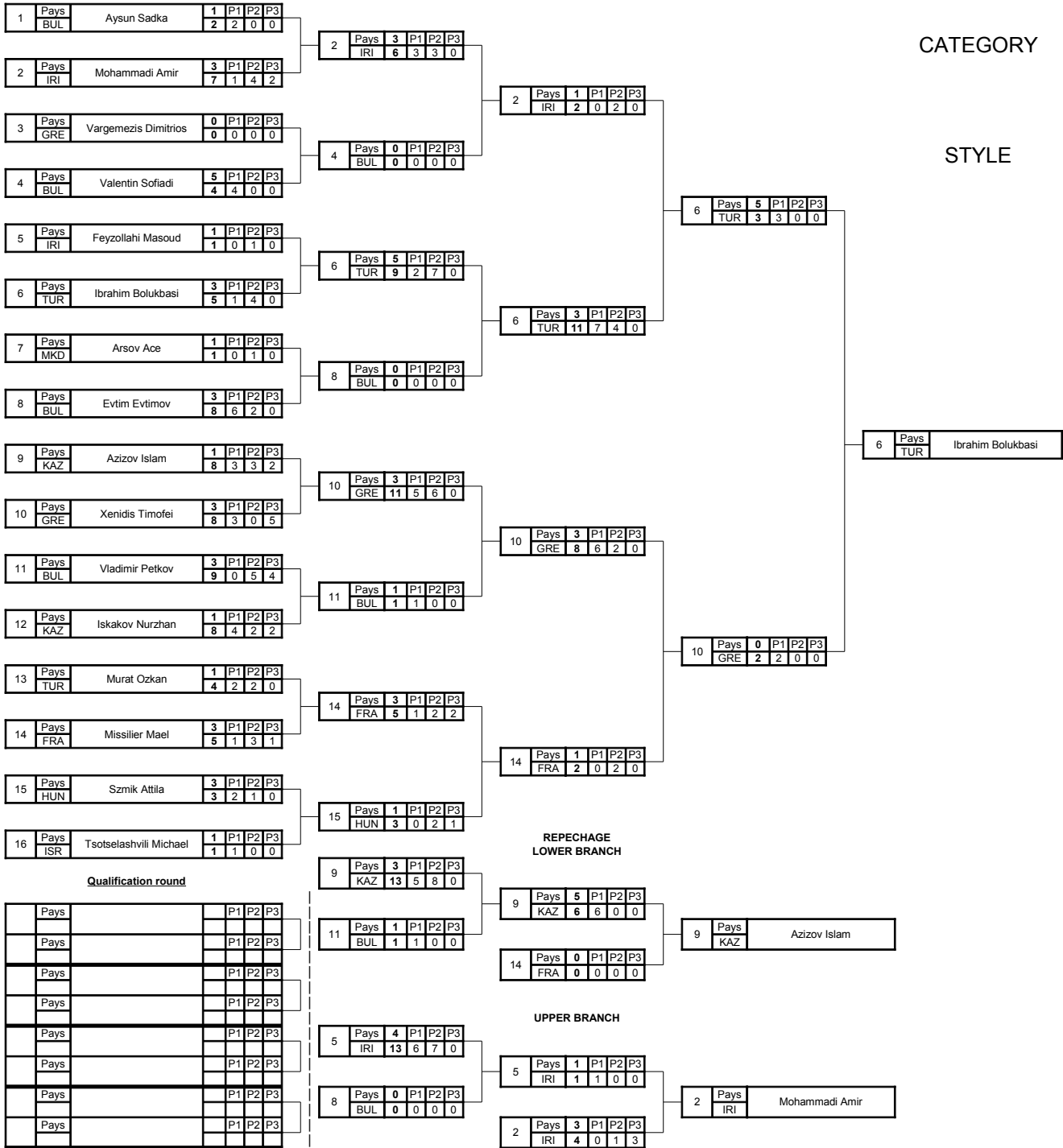



**INTERNATIONAL WRESTLING  
TOURNAMENT - JUNIORS FS**  
"PETKO SIRAKOV- IVAN ILIEV, 20-21.03.2010, SOFIA

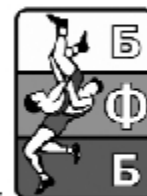

Category 84

Rank	No	Name	Country	C.P	Falls	E.M.	E.R	Win Points	Lost Points
1	6	Ibrahim Bolukbasi	TUR	16	1	0	2	28	5
2	10	Xenidis Timofei	GRE	9	0	0	2	29	14
3	2	Mohammadi Amir	IRI	10	0	0	0	19	14
3	9	Azizov Islam	KAZ	9	0	0	2	27	9
5	14	Missilier Mael	FRA	7	0	0	0	12	21
5	5	Feyzollahi Masoud	IRI	6	0	1	2	15	9
7	4	Valentin Sofiadi	BUL	5	1	0	0	4	6
8	11	Vladimir Petkov	BUL	5	0	0	0	11	32
9	15	Szmik Attila	HUN	4	0	0	0	6	6
10	8	Evtim Evtimov	BUL	3	0	0	1	8	23
11	12	Iskakov Nurzhan	KAZ	1	0	0	0	8	9
12	13	Murat Ozkan	TUR	1	0	0	0	4	5
13	1	Aysun Sadka	BUL	1	0	0	0	2	7
14	16	Tsotselashvili Michael	ISR	1	0	0	0	1	3
15	7	Arsov Ace	MKD	1	0	0	0	1	8
16	3	Vargemezis Dimitrios	GRE	0	0	0	0	0	4

# INTERNATIONAL WRESTLING TOURNAMENT -JUNIORS "PETKO SIRAKOV-IVAN ILIEV", 20-21.03.2010, SOFIA

1	Pays	Turculeanu Mihai	3	P1	P2	P3
	ROU		7	1	6	0
2	Pays	Toth Rafael	0	P1	P2	P3
	HUN		0	0	0	0
3	Pays	Bayram Rasim	0	P1	P2	P3
	BUL		0	0	0	0
4	Pays	Kasim Sarac	5	P1	P2	P3
	TUR		13	6	7	0
5	Pays	kazamiaghamashhadi Mosen	0	P1	P2	P3
	IRI		0	0	0	0
6	Pays	Fatih Yasarli	3	P1	P2	P3
	TUR		8	1	7	0
7	Pays	Bakenov Darkhan	3	P1	P2	P3
	KAZ		8	5	3	0
9	Pays	Vida Viktor	1	P1	P2	P3
	HUN		2	0	2	0

### Qualification round

7	Pays	Bakenov Darkhan	5	P1	P2	P3
	KAZ		5	2	3	0
8	Pays	Kuman Stoykov	0	P1	P2	P3
	BUL		1	1	0	0
9	Pays	Vida Viktor	3	P1	P2	P3
	HUN		10	3	7	0
10	Pays	Yassayev Backhan	0	P1	P2	P3
	FRA		0	0	0	0
	Pays			P1	P2	P3
	Pays			P1	P2	P3

1	Pays	1	P1	P2	P3
	ROU	2	2	0	0

4	Pays	3	P1	P2	P3
	TUR	4	0	2	2

6	Pays	3	P1	P2	P3
	TUR	11	2	3	6

7	Pays	1	P1	P2	P3
	KAZ	6	0	6	0

4	Pays	5	P1	P2	P3
	TUR	0	0	0	0

6	Pays	0	P1	P2	P3
	TUR	0	0	0	0

### REPECHAGE LOWER BRANCH

5	Pays	3	P1	P2	P3
	IRI	7	6	1	0

7	Pays	0	P1	P2	P3
	KAZ	0	0	0	0

5	Pays	Kazamiaghamashhadi Mosen
	IRI	

### UPPER BRANCH

3	Pays	0	P1	P2	P3
	BUL	0	0	0	0

1	Pays	5	P1	P2	P3
	ROU	4	4	0	0

1	Pays	Turculeanu Mihai
	ROU	

CATEGORY

**96**

STYLE

**FS**

4	Pays	Kasim Sarac
	TUR	





**INTERNATIONAL WRESTLING  
TOURNAMENT - JUNIORS FS**  
"PETKO SIRAKOV- IVAN ILIEV, 20-21.03.2010, SOFIA

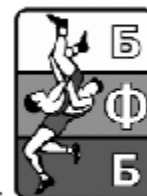

Category 96

Rank	No	Name	Country	C.P	Falls	E.M.	E.R	Win Points	Lost Points
1	4	Kasim Sarac	TUR	13	1	1	2	17	2
2	6	Fatih Yasarli	TUR	6	0	0	2	19	6
3	5	Kazamiaghamashhadi Mosen	IRI	3	0	0	1	7	8
3	1	Turculeanu Mihai	ROU	9	0	0	1	13	4
5	3	Bayram Rasim	BUL	0	0	0	0	0	17
5	7	Bakenov Darkhan	KAZ	9	0	0	0	19	21
7	9	Vida Viktor	HUN	4	0	0	1	12	8
8	8	Kuman Stoykov	BUL	0	0	0	0	1	5
9	2	Toth Rafael	HUN	0	0	0	0	0	7
10	10	Yassayev Backhan	FRA	0	0	0	0	0	10

# INTERNATIONAL WRESTLING TOURNAMENT -JUNIORS "PETKO SIRAKOV-IVAN ILIEV", 20-21.03.2010, SOFIA

1	Pays	YukseI YukseI	0	P1	P2	P3
	BUL		0	0	0	0
2	Pays	Onofrei Seraiv	3	P1	P2	P3
	ROU		4	2	2	0
3	Pays	Csercsics Richard	0	P1	P2	P3
	HUN		0	0	0	0
4	Pays	Taha Akgul	3	P1	P2	P3
	TUR		2	1	1	0
5	Pays	Aslanov Amin	0	P1	P2	P3
	ISR		0	0	0	0
7	Pays	Yalcin Sozen	5	P1	P2	P3
	TUR		7	7	0	0
8	Pays	Daniel Yankov	3	P1	P2	P3
	BUL		3	1	2	0
11	Pays	Asadiaraei Hamed	1	P1	P2	P3
	IRI		1	0	1	0

### Qualification round

6	Pays	Hutnan Marian	1	P1	P2	P3
	SVK		1	0	1	0
7	Pays	Yalcin Sozen	3	P1	P2	P3
	TUR		4	1	3	0
8	Pays	Daniel Yankov	4	P1	P2	P3
	BUL		12	6	6	0
9	Pays	Slavei Velkov	0	P1	P2	P3
	BUL		0	0	0	0
10	Pays	Seitzhanov Meirkhan	1	P1	P2	P3
	KAZ		1	1	0	0
11	Pays	Asadiaraei Hamed	3	P1	P2	P3
	IRI		2	1	1	0
	Pays			P1	P2	P3
	Pays			P1	P2	P3

2	Pays		0	P1	P2	P3
	ROU		0	0	0	0
4	Pays		4	P1	P2	P3
	TUR		13	7	6	0
7	Pays		3	P1	P2	P3
	TUR		4	0	1	3
8	Pays		1	P1	P2	P3
	BUL		4	3	1	0

4	Pays		3	P1	P2	P3
	TUR		8	5	3	0
7	Pays		0	P1	P2	P3
	TUR		0	0	0	0

CATEGORY **120**

STYLE **FS**

4	Pays	Taha Akgul
	TUR	

### REPECHAGE LOWER BRANCH

6	Pays		4	P1	P2	P3
	SVK		12	6	6	0
5	Pays		0	P1	P2	P3
	ISR		0	0	0	0

6	Pays		0	P1	P2	P3
	SVK		0	0	0	0
8	Pays		3	P1	P2	P3
	BUL		2	1	1	0

8	Pays	Daniel Yankov
	BUL	

### UPPER BRANCH

3	Pays		3	P1	P2	P3
	HUN		9	2	7	0
2	Pays		0	P1	P2	P3
	ROU		0	0	0	0

	Pays					
3	Pays					
	HUN					

3	Pays	Csercsics Richard
	HUN	



**INTERNATIONAL WRESTLING  
TOURNAMENT - JUNIORS FS**  
"PETKO SIRAKOV- IVAN ILIEV, 20-21.03.2010, SOFIA

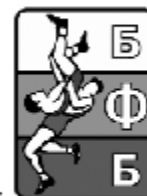

Category 120

Rank	No	Name	Country	C.P	Falls	E.M.	E.R	Win Points	Lost Points
1	4	Taha Akgul	TUR	10	0	1	2	23	0
2	7	Yalcin Sozen	TUR	11	0	0	1	15	13
3	3	Csercsics Richard	HUN	3	0	0	1	9	2
3	8	Daniel Yankov	BUL	11	0	1	2	21	5
5	6	Hutnan Marian	SVK	5	0	1	2	13	6
5	2	Onofrei Seraiv	ROU	3	0	0	0	4	22
7	11	Asadiaraei Hamed	IRI	4	0	0	0	3	4
8	10	Seitzhanov Meirkhan	KAZ	1	0	0	0	1	2
9	1	Yuksel Yuksel	BUL	0	0	0	0	0	4
10	9	Slavei Velkov	BUL	0	0	0	0	0	12
11	5	Aslanov Amin	ISR	0	0	0	0	0	19



# INTERNATIONAL WRESTLING TOURNAMENT - JUNIORS GR

\*PETKO SIRAKOV- IVAN ILIEV, 20-21.03.2010, SOFIA



	50	55	60	66	74	84	96	120	Grand Total
ALG	1	1	1	1	1				5
BUL	2	5	3	2	4	5	2	2	25
CRO			1	1		1	1	1	5
CZE				2	1				3
FRA		1			1	1			3
HUN	1		1	2	1	2	1	1	9
IRI	1	2	2	2	1	2	1	1	12
ISR		1							1
ITA			1		2	2	1		6
KAZ	1	4	4	3	2	1	3	2	20
ROU	1	3		3		1			8
TUR	2	3	2	2	2	2	2	2	17
USA	1	1	1	3	1	1	1		9
<b>Grand Total</b>	<b>10</b>	<b>21</b>	<b>16</b>	<b>21</b>	<b>16</b>	<b>18</b>	<b>12</b>	<b>9</b>	<b>123</b>



**INTERNATIONAL WRESTLING TOURNAMENT, JUNIORS**  
**FREE STYLE & GRECO-ROMAN STYLE**  
**"PETKO SIRAKOV - IVAN ILIEV"**  
**20-21.03.2010, SOFIA, BULGARIA**

---

---

**MEDALISTS - GRECO-ROMAN STYLE**

**cat. 50 kg**

1 Sarsembiyev Zhanserik	KAZ
2 Kabomeri Amir	IRI
3 Nikolay Vichev	BUL
3 Talgahan Karatas	TUR

**cat. 55 kg**

1 Baizakov Aisultan	KAZ
2 Jesse Thielke	USA
3 Umbektaliyev Artur	KAZ
3 Murat Batmaz	TUR

**cat. 60 kg**

1 Kozak Istvan	HUN
2 Valentin Tsvetkov	BUL
3 Hasan Tahsin Ozkul	TUR
3 Kikbayev Yerbol	KAZ

**cat. 66 kg**

1 Szabo Laszlo	HUN
2 Nigmatulin Renat	KAZ
3 Ellis Coleman	USA
3 Zhanbirov Askhat	KAZ

**cat. 74 kg**

1 Yerezhpov Maxat	KAZ
2 Mohammedalizadeh Kamal	IRI
3 Radi Nedkov	BUL
3 Hlavati Daniel	HUN

**cat. 84 kg**

1 Benjamin Provisor	USA
2 Vescau Cyrih	FRA
3 Stanislav Kanev	BUL
3 Nikityuk Nikolay	KAZ

**cat. 96 kg**

1 Hyusein Hyusein	BUL
2 Rizmajer Gyorgy	HUN
3 Serkan Aydemir	TUR
3 Mamizadeh Mojtaba	IRI

**cat. 120 kg**

1 Nazari Parsa	IRI
2 Lam Balint	HUN
3 Marco Koscevic	CRO
3 Bayram Nigar	TUR

*The best international wrestler GR - Benjamin Provisor, cat. 84 kg, USA*

*The best Bulgarian wrestler GR - Hyusein Hyusein, cat. 96, BUL*

# INTERNATIONAL WRESTLING TOURNAMENT - JUNIORS "PETKO SIRAKOV-IVAN ILIEV", 20-21.03.2010, SOFIA

1	Pays	Talgahan Karatas	1	P1	P2	P3
	TUR		2	2	0	0
2	Pays	Sarsembiyev Zhanserik	3	P1	P2	P3
	KAZ		9	0	3	6
3	Pays	Vagiunic Cristian	3	P1	P2	P3
	ROU		5	2	2	1
4	Pays	Juhasz Bence	1	P1	P2	P3
	HUN		4	0	4	0
5	Pays	Kabomeri Amir	3	P1	P2	P3
	IRI		5	4	1	0
6	Pays	Stefan Stoichev	0	P1	P2	P3
	BUL		0	0	0	0
8	Pays	Max Nowry	1	P1	P2	P3
	USA		1	0	1	0
10	Pays	Nikolay Vichev	3	P1	P2	P3
	BUL		5	1	4	0

### Qualification round

7	Pays	Abdellaoui Abdenour	0	P1	P2	P3
	ALG		0	0	0	0
8	Pays	Max Nowry	3	P1	P2	P3
	USA		9	3	6	0
9	Pays	Ibrahim Biyik	1	P1	P2	P3
	TUR		1	0	1	0
10	Pays	Nikolay Vichev	3	P1	P2	P3
	BUL		6	3	0	3
	Pays			P1	P2	P3
	Pays			P1	P2	P3
	Pays			P1	P2	P3
	Pays			P1	P2	P3

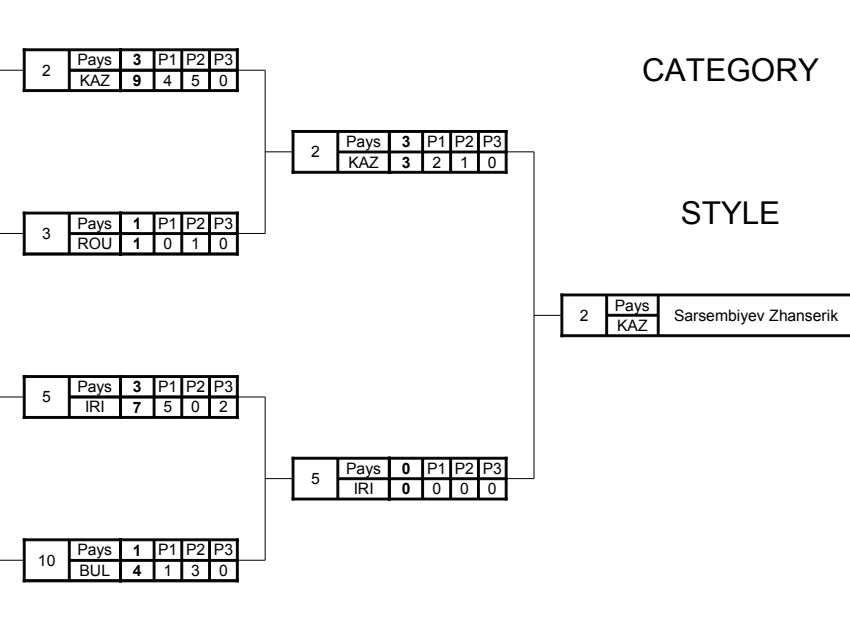

CATEGORY **50**  
STYLE **GR**

### REPECHAGE LOWER BRANCH

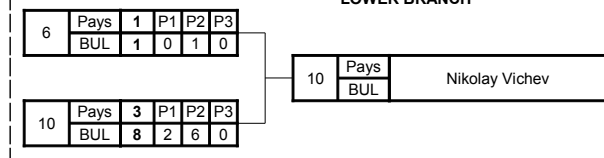

### UPPER BRANCH

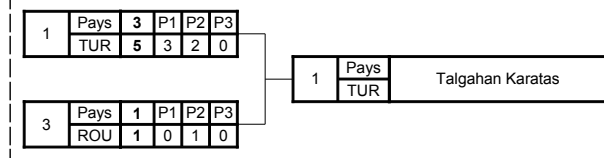



**INTERNATIONAL WRESTLING  
TOURNAMENT - JUNIORS GR**  
“PETKO SIRAKOV- IVAN ILIEV, 20-21.03.2010, SOFIA



Category 50

Rank	No	Name	Country	C.P	Falls	E.M.	E.R	Win Points	Lost Points
1	2	Sarsembiyev Zhanserik	KAZ	9	0	0	1	21	3
2	5	Kabomeri Amir	IRI	6	0	0	0	12	7
3	1	Talgahan Karatas	TUR	4	0	0	0	7	10
3	10	Nikolay Vichev	BUL	10	0	0	0	23	10
5	6	Stefan Stoichev	BUL	1	0	0	0	1	13
5	3	Vagiunic Cristian	ROU	5	0	0	0	7	18
7	8	Max Nowry	USA	4	0	0	1	10	5
8	4	Juhasz Bence	HUN	1	0	0	0	4	5
9	9	Ibrahim Biyik	TUR	1	0	0	0	1	6
10	7	Abdellaoui Abdenour	ALG	0	0	0	0	0	9

# INTERNATIONAL WRESTLING TOURNAMENT - JUNIORS "PETKO SIRAKOV-IVAN ILIEV", 20-21.03.2010, SOFIA

CATEGORY **55**

STYLE **GR**

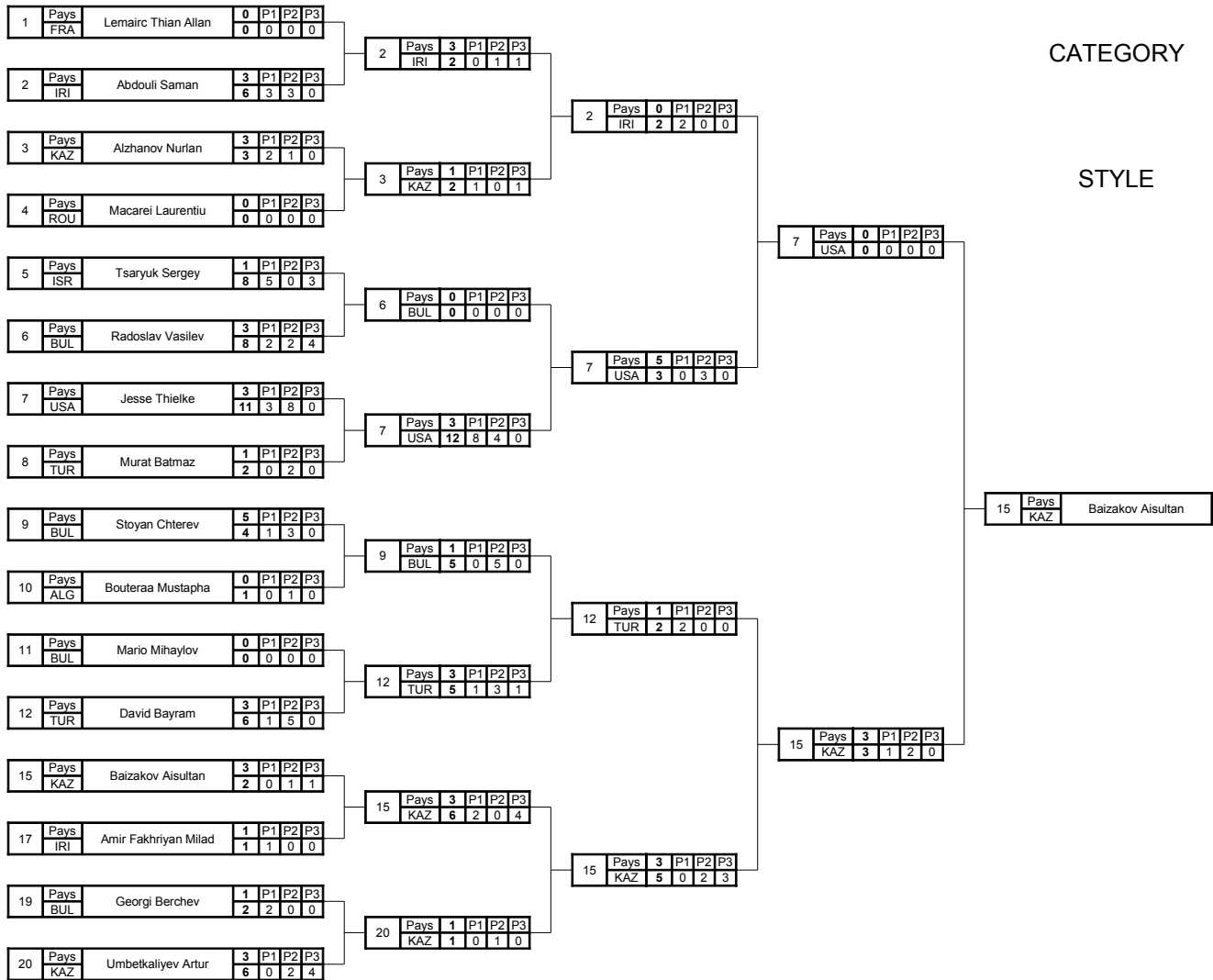

**Qualification round**

12	Pays TUR	David Bayram	3	P1	P2	P3
			9	5	4	0
13	Pays BUL	Nasko Georgiev	0	P1	P2	P3
			0	0	0	0
14	Pays ROU	Atanasoale Ovidiu	0	P1	P2	P3
			0	0	0	0
15	Pays KAZ	Baizakov Aisultan	3	P1	P2	P3
			5	1	4	0
16	Pays TUR	Furken Demir	0	P1	P2	P3
			0	0	0	0
17	Pays IRI	Amir Fakhriyan Milad	3	P1	P2	P3
			3	1	2	0
18	Pays ROU	Serban Emanuel	1	P1	P2	P3
			3	0	3	0
19	Pays BUL	Georgi Berchev	3	P1	P2	P3
			5	1	4	0
20	Pays KAZ	Umbetkaliyev Artur	3	P1	P2	P3
			7	2	5	0
21	Pays KAZ	Zharbolov Madi	1	P1	P2	P3
			1	0	1	0

**REPECHAGE  
LOWER BRANCH**

14	Pays ROU		0	P1	P2	P3
			0	0	0	0
17	Pays IRI		5	P1	P2	P3
			5	5	0	0

**UPPER BRANCH**

8	Pays TUR		3	P1	P2	P3
			2	1	0	1
6	Pays BUL		1	P1	P2	P3
			2	0	2	0

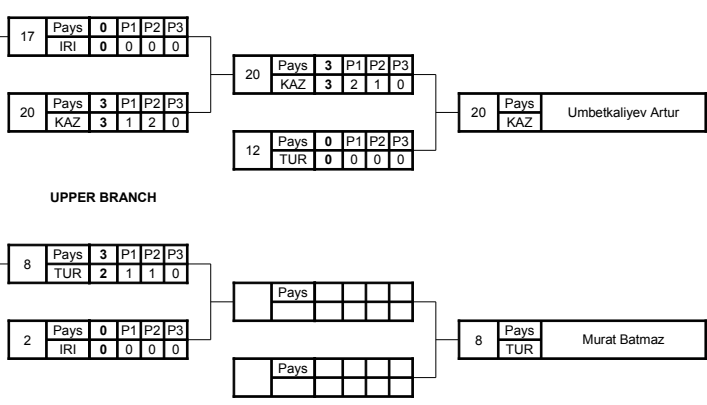

15 Pays  
KAZ Baizakov Aisultan

15 Pays  
KAZ 3 1 2 0

15 Pays  
KAZ 5 0 2 3

20 Pays  
KAZ Umbetkaliyev Artur

8 Pays  
TUR Murat Batmaz





**INTERNATIONAL WRESTLING  
TOURNAMENT - JUNIORS GR**  
\*PETKO SIRAKOV- IVAN ILIEV, 20-21.03.2010, SOFIA

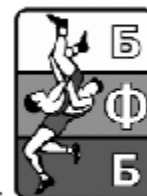

Category 55

Rank	No	Name	Country	C.P	Falls	E.M.	E.R	Win Points	Lost Points
1	15	Baizakov Aisultan	KAZ	15	0	0	0	21	4
2	7	Jesse Thielke	USA	11	1	0	2	26	7
3	8	Murat Batmaz	TUR	7	0	0	0	6	13
3	20	Umbetkaliyev Artur	KAZ	13	0	0	0	20	9
5	2	Abdouli Saman	IRI	6	0	0	0	10	7
5	12	David Bayram	TUR	10	0	0	0	22	13
7	17	Amir Fakhriyan Milad	IRI	9	0	0	0	9	5
8	9	Stoyan Chterev	BUL	6	1	0	0	9	6
9	6	Radoslav Vasilev	BUL	4	0	0	0	10	22
10	19	Georgi Berchev	BUL	4	0	0	0	7	9
11	3	Alzhanov Nurlan	KAZ	4	0	0	0	5	2
12	5	Tsaryuk Sergey	ISR	1	0	0	0	8	8
13	18	Serban Emanuel	ROU	1	0	0	0	3	5
14	21	Zharbolov Madi	KAZ	1	0	0	0	1	7
15	10	Bouteraa Mustapha	ALG	0	0	0	0	1	4
16	16	Furken Demir	TUR	0	0	0	0	0	3
17	4	Macarei Laurentiu	ROU	0	0	0	0	0	3
18	11	Mario Mihaylov	BUL	0	0	0	0	0	6
19	1	Lemairc Thian Allan	FRA	0	0	0	0	0	6
20	13	Nasko Georgiev	BUL	0	0	0	0	0	9
21	14	Atanasoaie Ovidiu	ROU	0	0	0	0	0	10

# INTERNATIONAL WRESTLING TOURNAMENT - JUNIORS "PETKO SIRAKOV-IVAN ILIEV", 20-21.03.2010, SOFIA

CATEGORY **60**

STYLE **GR**

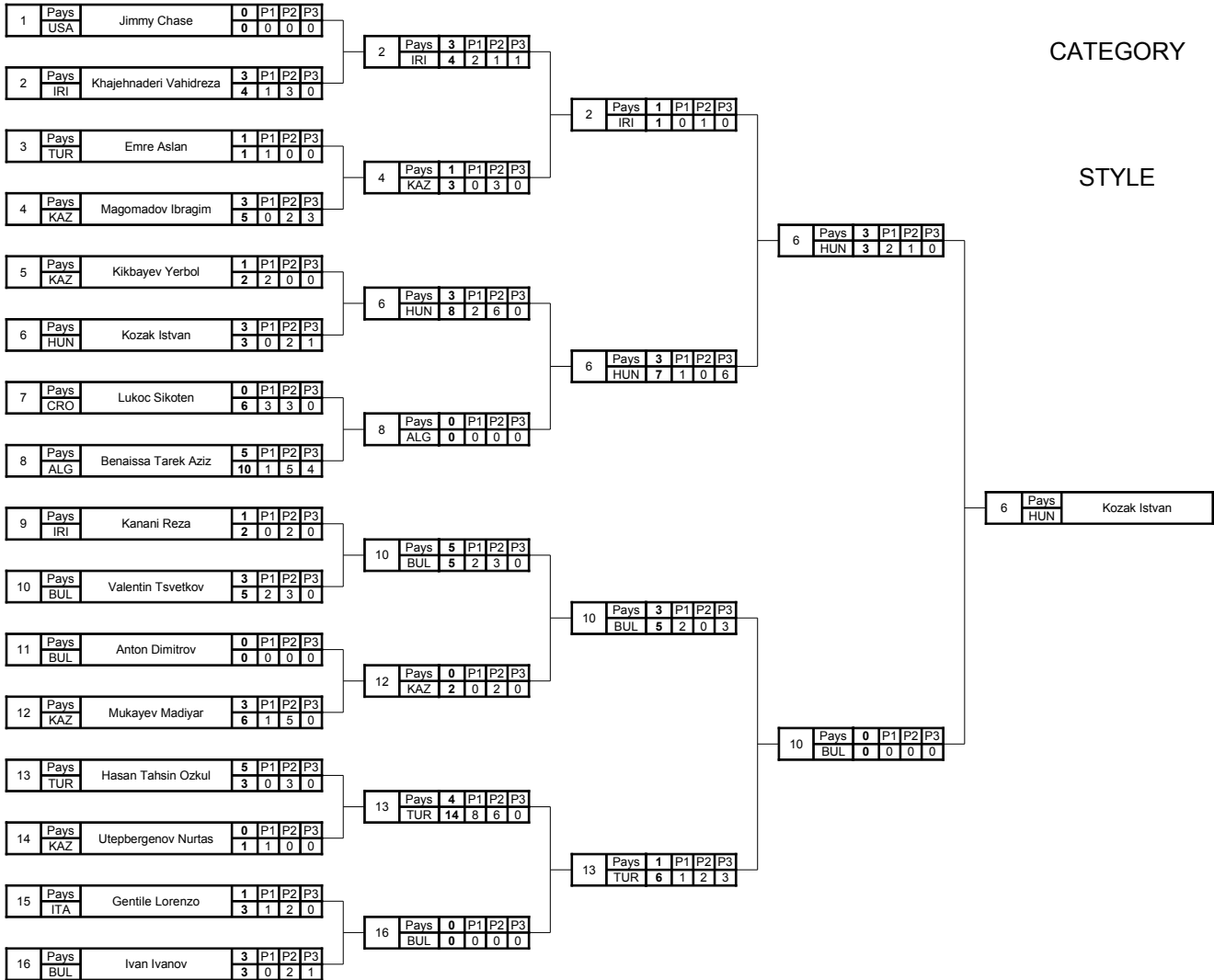

**Qualification round**

**REPECHAGE LOWER BRANCH**

**UPPER BRANCH**



**INTERNATIONAL WRESTLING  
TOURNAMENT - JUNIORS GR**  
\*PETKO SIRAKOV- IVAN ILIEV, 20-21.03.2010, SOFIA



Category 60

Rank	No	Name	Country	C.P	Falls	E.M.	E.R	Win Points	Lost Points
1	6	Kozak Istvan	HUN	12	0	0	2	21	3
2	10	Valentin Tsvetkov	BUL	11	1	0	0	15	13
3	13	Hasan Tahsin Ozkul	TUR	13	1	1	2	29	6
3	5	Kikbayev Yerbol	KAZ	7	0	0	0	8	3
5	2	Khajehnaderi Vahidreza	IRI	7	0	0	0	9	13
5	9	Kanani Reza	IRI	4	0	0	0	5	12
7	8	Benaissa Tarek Aziz	ALG	5	1	0	0	10	17
8	12	Mukayev Madiyar	KAZ	4	0	0	0	9	8
9	4	Magomadov Ibragim	KAZ	4	0	0	0	8	5
10	16	Ivan Ivanov	BUL	3	0	0	0	3	17
11	15	Gentile Lorenzo	ITA	1	0	0	0	3	3
12	3	Emre Aslan	TUR	1	0	0	0	1	5
13	7	Lukoc Sikoten	CRO	0	0	0	0	6	10
14	14	Utepbergenov Nurtas	KAZ	0	0	0	0	1	3
15	1	Jimmy Chase	USA	0	0	0	0	0	4
16	11	Anton Dimitrov	BUL	0	0	0	0	0	6

# INTERNATIONAL WRESTLING TOURNAMENT - JUNIORS "PETKO SIRAKOV-IVAN ILIEV", 20-21.03.2010, SOFIA

CATEGORY **66**

STYLE **GR**

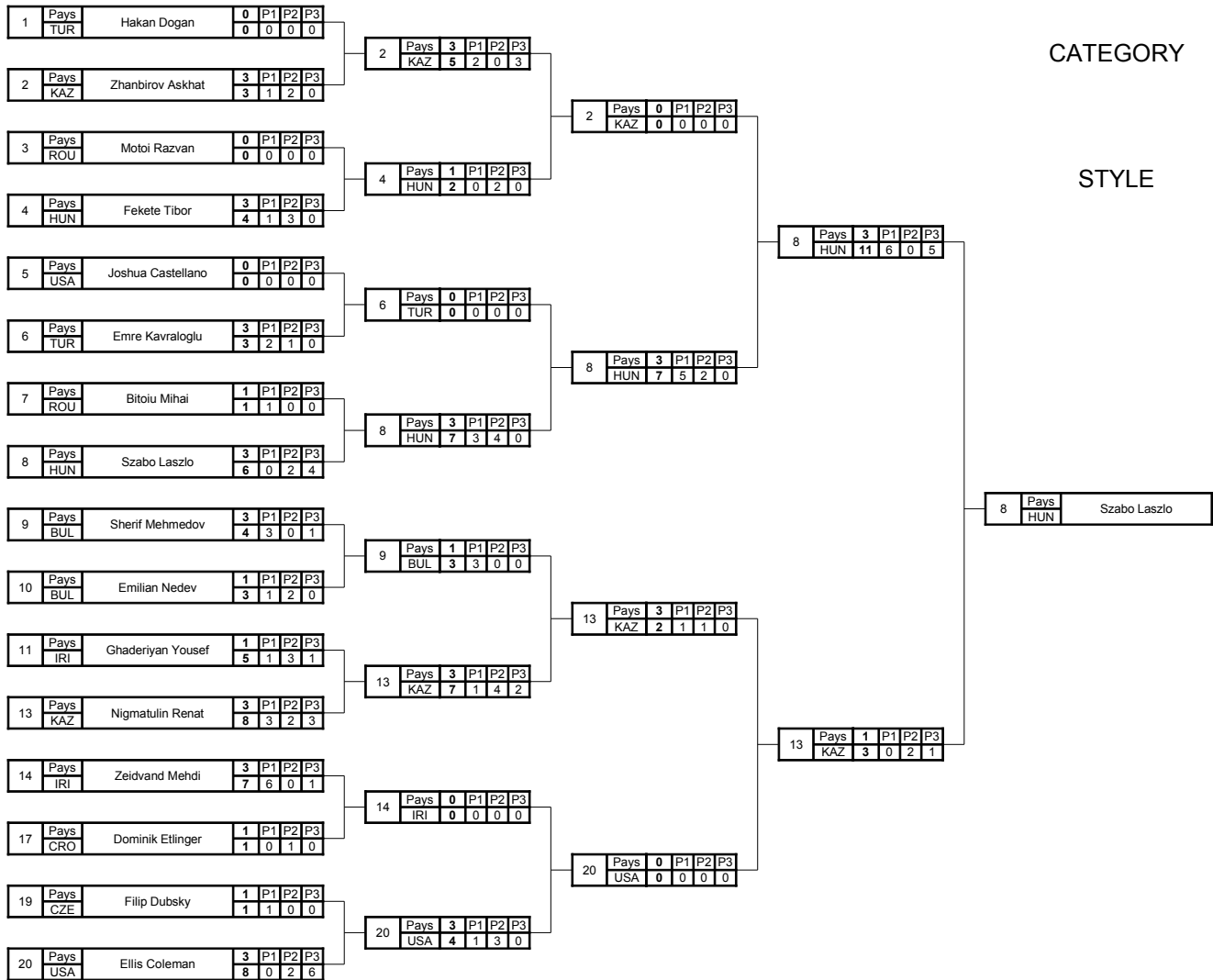

**Qualification round**

12	Pays KAZ	Abdinabi Shakhmurat	0	P1	P2	P3	0	0	0
13	Pays KAZ	Nigmatulin Renat	3	P1	P2	P3	2	1	1
14	Pays IRI	Zeidvand Mehdi	3	P1	P2	P3	4	3	1
15	Pays USA	Tanner Andrews	0	P1	P2	P3	0	0	0
16	Pays CZE	Petr Janda	1	P1	P2	P3	3	0	3
17	Pays CRO	Dominik Ettinger	3	P1	P2	P3	14	5	9
18	Pays ALG	Dekiche Ahmed	0	P1	P2	P3	0	0	0
19	Pays CZE	Filip Dubsky	3	P1	P2	P3	7	3	4
20	Pays USA	Ellis Coleman	3	P1	P2	P3	11	4	7
21	Pays ROU	Mocanu Florin	0	P1	P2	P3	0	0	0

**REPECHAGE  
LOWER BRANCH**

12	Pays KAZ	1	P1	P2	P3	2	0	2	0
11	Pays IRI	3	P1	P2	P3	11	7	4	0
7	Pays ROU	0	P1	P2	P3	0	0	0	0
6	Pays TUR	3	P1	P2	P3	2	1	1	0

**UPPER BRANCH**

11	Pays IRI	3	P1	P2	P3	9	4	5	0
9	Pays BUL	1	P1	P2	P3	1	0	1	0
6	Pays TUR	0	P1	P2	P3	1	1	0	0
2	Pays KAZ	5	P1	P2	P3	12	1	8	3

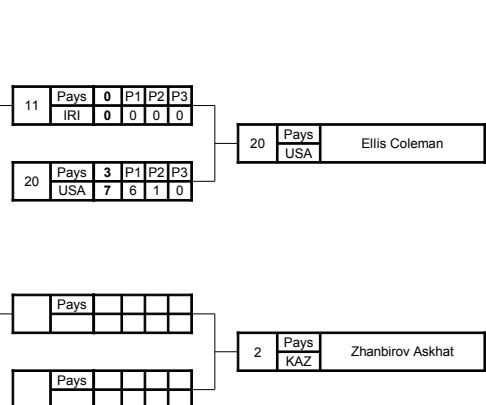



**INTERNATIONAL WRESTLING  
TOURNAMENT - JUNIORS GR**  
\*PETKO SIRAKOV- IVAN ILIEV, 20-21.03.2010, SOFIA



Category 66

Rank	No	Name	Country	C.P	Falls	E.M.	E.R	Win Points	Lost Points
1	8	Szabo Laszlo	HUN	12	0	0	1	31	4
2	13	Nigmatulin Renat	KAZ	13	0	0	0	22	19
3	2	Zhanbirov Askhat	KAZ	11	1	0	1	20	10
3	20	Ellis Coleman	USA	12	0	0	3	30	3
5	11	Ghaderiyan Yousef	IRI	7	0	0	1	25	18
5	6	Emre Kavraloglu	TUR	6	0	0	0	6	19
7	14	Zeidvand Mehdi	IRI	6	0	0	1	11	5
8	9	Sherif Mehmedov	BUL	5	0	0	0	8	19
9	17	Dominik Etlinger	CRO	4	0	0	1	15	10
10	19	Filip Dubsky	CZE	4	0	0	0	8	8
11	4	Fekete Tibor	HUN	4	0	0	0	6	5
12	10	Emilian Nedev	BUL	1	0	0	0	3	4
13	16	Petr Janda	CZE	1	0	0	0	3	14
14	12	Abdinabi Shakhmurat	KAZ	1	0	0	0	2	13
15	7	Bitoiu Mihai	ROU	1	0	0	0	1	8
16	1	Hakan Dogan	TUR	0	0	0	0	0	3
17	5	Joshua Castellano	USA	0	0	0	0	0	3
18	3	Motoi Razvan	ROU	0	0	0	0	0	4
19	15	Tanner Andrews	USA	0	0	0	0	0	4
20	18	Dekiche Ahmed	ALG	0	0	0	0	0	7
21	21	Mocanu Florin	ROU	0	0	0	0	0	11

# INTERNATIONAL WRESTLING TOURNAMENT - JUNIORS "PETKO SIRAKOV-IVAN ILIEV", 20-21.03.2010, SOFIA

CATEGORY **74**

STYLE **GR**

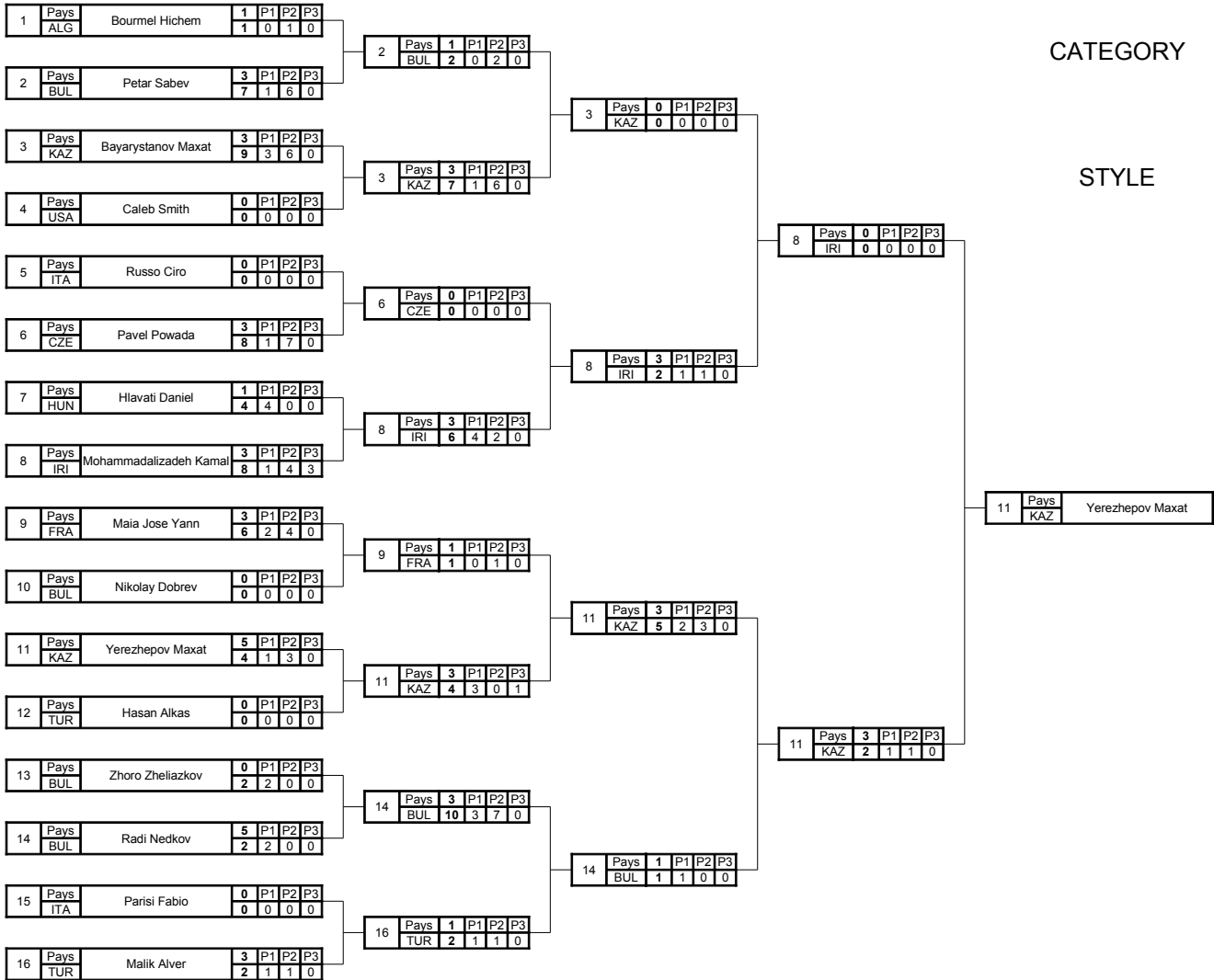

**Qualification round**

Pays		P1	P2	P3
Pays		P1	P2	P3
Pays		P1	P2	P3
Pays		P1	P2	P3
Pays		P1	P2	P3
Pays		P1	P2	P3
Pays		P1	P2	P3
Pays		P1	P2	P3

**REPECHAGE LOWER BRANCH**

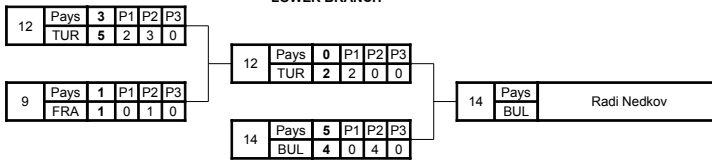

**UPPER BRANCH**

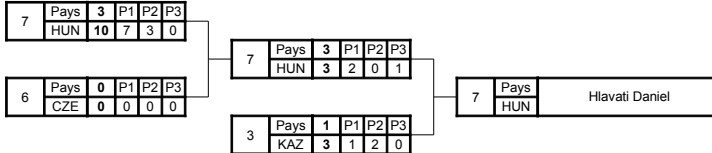



**INTERNATIONAL WRESTLING  
TOURNAMENT - JUNIORS GR**  
“PETKO SIRAKOV- IVAN ILIEV, 20-21.03.2010, SOFIA



Category 74

Rank	No	Name	Country	C.P	Falls	E.M.	E.R	Win Points	Lost Points
1	11	Yezhezhevov Maxat	KAZ	14	1	0	0	15	2
2	8	Mohammadalizadeh Kamal	IRI	9	0	0	0	16	6
3	14	Radi Nedkov	BUL	14	1	0	1	17	11
3	7	Hlavati Daniel	HUN	7	0	0	1	17	11
5	12	Hasan Alkas	TUR	3	0	0	0	7	9
5	3	Bayarystanov Maxat	KAZ	7	0	0	1	19	7
7	9	Maia Jose Yann	FRA	5	0	0	0	8	9
8	2	Petar Sabev	BUL	4	0	0	0	9	8
9	16	Malik Alver	TUR	4	0	0	0	4	10
10	6	Pavel Powada	CZE	3	0	0	1	8	16
11	1	Bourmel Hichem	ALG	1	0	0	0	1	7
12	13	Zhorozheliyazkov	BUL	0	0	0	0	2	2
13	15	Parisi Fabio	ITA	0	0	0	0	0	2
14	10	Nikolay Dobrev	BUL	0	0	0	0	0	6
15	5	Russo Ciro	ITA	0	0	0	0	0	8
16	4	Caleb Smith	USA	0	0	0	0	0	9

# INTERNATIONAL WRESTLING TOURNAMENT - JUNIORS "PETKO SIRAKOV-IVAN ILIEV", 20-21.03.2010, SOFIA

CATEGORY **84**

STYLE **GR**

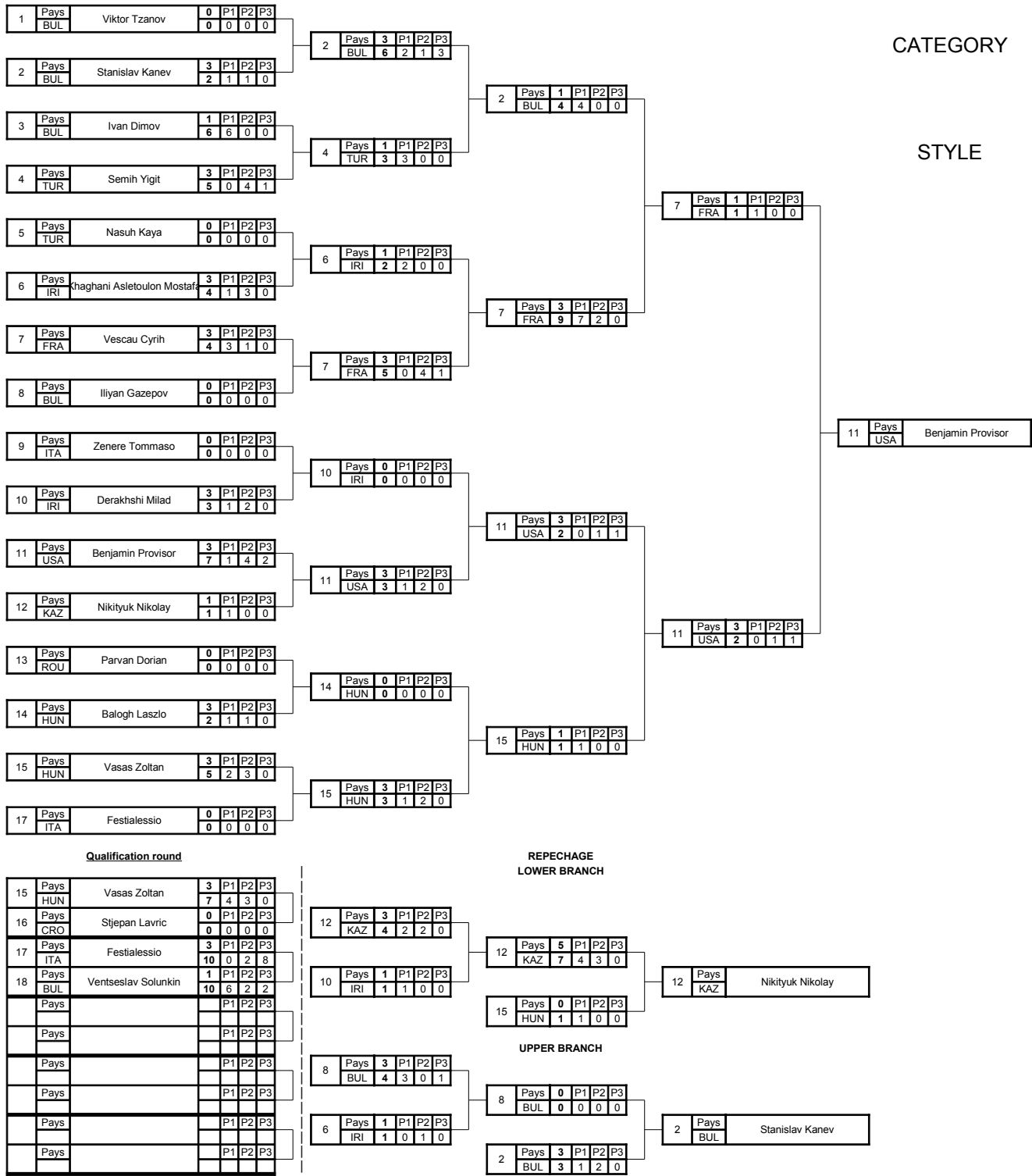





**INTERNATIONAL WRESTLING  
TOURNAMENT - JUNIORS GR**  
\*PETKO SIRAKOV- IVAN ILIEV, 20-21.03.2010, SOFIA



Category 84

Rank	No	Name	Country	C.P	Falls	E.M.	E.R	Win Points	Lost Points
1	11	Benjamin Provisor	USA	12	0	0	0	14	3
2	7	Vescau Cyrih	FRA	10	0	0	0	19	8
3	2	Stanislav Kanev	BUL	10	0	0	0	15	12
3	12	Nikityuk Nikolay	KAZ	9	1	0	0	12	9
5	15	Vasas Zoltan	HUN	10	0	0	0	17	9
5	8	Iliyan Gazepov	BUL	3	0	0	0	4	8
7	6	Khaghani Asletoulon Mostafa	IRI	5	0	0	0	7	9
8	4	Semih Yigit	TUR	4	0	0	0	8	12
9	10	Derakhshi Milad	IRI	4	0	0	0	4	7
10	17	Festialessio	ITA	3	0	0	1	10	15
11	14	Balogh Laszlo	HUN	3	0	0	0	2	3
12	18	Ventseslav Solunkin	BUL	1	0	0	1	10	10
13	3	Ivan Dimov	BUL	1	0	0	1	6	5
14	13	Parvan Dorian	ROU	0	0	0	0	0	2
15	1	Viktor Tzanov	BUL	0	0	0	0	0	2
16	9	Zenere Tommaso	ITA	0	0	0	0	0	3
17	5	Nasuh Kaya	TUR	0	0	0	0	0	4
18	16	Stjepan Lavric	CRO	0	0	0	0	0	7

# INTERNATIONAL WRESTLING TOURNAMENT - JUNIORS

## "PETKO SIRAKOV-IVAN ILIEV", 20-21.03.2010, SOFIA

CATEGORY

**96**

STYLE

**GR**

1	Pays	Serkan Aydemir	3	P1	P2	P3
	TUR		7	3	4	0
2	Pays	Nastochenko Ilya	1	P1	P2	P3
	KAZ		3	2	1	0
3	Pays	Hyusein Hyusein	3	P1	P2	P3
	BUL		7	2	5	0
4	Pays	Tvalabeishvili Nika	0	P1	P2	P3
	KAZ		0	0	0	0
6	Pays	Mamizadeh Mojtaba	0	P1	P2	P3
	IRI		0	0	0	0
7	Pays	Rizmajer Gyorgy	3	P1	P2	P3
	HUN		3	1	2	0
9	Pays	Tomislav Lavric	1	P1	P2	P3
	CRO		4	4	0	0
11	Pays	Dimcho Dimchev	3	P1	P2	P3
	BUL		6	0	5	1

1	Pays	1	P1	P2	P3
	TUR	2	2	0	0

3	Pays	3	P1	P2	P3
	BUL	4	0	4	0

3	Pays	3	P1	P2	P3
	BUL	5	4	1	0

3	Pays	Hyusein Hyusein
	BUL	

7	Pays	4	P1	P2	P3
	HUN	13	6	7	0

7	Pays	1	P1	P2	P3
	HUN	5	3	2	0

11	Pays	0	P1	P2	P3
	BUL	0	0	0	0

**Qualification round**

5	Pays	Metahan Basar	1	P1	P2	P3
	TUR		1	0	1	0
6	Pays	Mamizadeh Mojtaba	3	P1	P2	P3
	IRI		2	1	0	1
7	Pays	Rizmajer Gyorgy	3	P1	P2	P3
	HUN		13	9	4	0
8	Pays	Ashimbayev Aidyn	1	P1	P2	P3
	KAZ		3	3	0	0
9	Pays	Tomislav Lavric	3	P1	P2	P3
	CRO		5	4	1	0
10	Pays	Robert Barbour	0	P1	P2	P3
	USA		0	0	0	0
11	Pays	Dimcho Dimchev	5	P1	P2	P3
	BUL		4	4	0	0
12	Pays	Minguzzi Luca	0	P1	P2	P3
	ITA		0	0	0	0

**REPECHAGE  
LOWER BRANCH**

8	Pays	1	P1	P2	P3
	KAZ	6	6	0	0

4	Pays	1	P1	P2	P3
	KAZ	5	0	3	2

6	Pays	3	P1	P2	P3
	IRI	3	0	2	1

1	Pays	3	P1	P2	P3
	TUR	4	1	0	3

1	Pays	Serkan Aydemir
	TUR	

**UPPER BRANCH**

	Pays				
--	------	--	--	--	--

6	Pays	3	P1	P2	P3
	IRI	2	1	1	0

	Pays				
--	------	--	--	--	--

11		0	P1	P2	P3
	BUL	0	0	0	0

6	Pays	Mamizadeh Mojtaba
	IRI	



**INTERNATIONAL WRESTLING  
TOURNAMENT - JUNIORS GR**  
“PETKO SIRAKOV- IVAN ILIEV, 20-21.03.2010, SOFIA



Category 96

Rank	No	Name	Country	C.P	Falls	E.M.	E.R	Win Points	Lost Points
1	3	Hyusein Hyusein	BUL	9	0	0	0	16	7
2	7	Rizmajer Gyorgy	HUN	11	0	1	3	34	7
3	1	Serkan Aydemir	TUR	7	0	0	0	13	13
3	6	Mamizadeh Mojtaba	IRI	9	0	0	0	7	10
5	11	Dimcho Dimchev	BUL	8	1	0	0	10	19
5	4	Tvalabeishvili Nika	KAZ	1	0	0	0	5	11
7	9	Tomislav Lavric	CRO	4	0	0	0	9	6
8	8	Ashimbayev Aidyn	KAZ	2	0	0	1	9	16
9	2	Nastochenko Ilya	KAZ	1	0	0	0	3	7
10	5	Metahan Basar	TUR	1	0	0	0	1	2
11	12	Minguzzi Luca	ITA	0	0	0	0	0	4
12	10	Robert Barbour	USA	0	0	0	0	0	5

# INTERNATIONAL WRESTLING TOURNAMENT - JUNIORS

## "PETKO SIRAKOV-IVAN ILIEV", 20-21.03.2010, SOFIA

1	Pays	Marko Koscevic	0	P1	P2	P3
	CRO		0	0	0	0
2	Pays	Nazari Parsa	5	P1	P2	P3
	IRI		3	1	2	0
3	Pays	Engin Dagli	0	P1	P2	P3
	TUR		0	0	0	0
4	Pays	Miloslav Metodiev	3	P1	P2	P3
	BUL		3	1	2	0
5	Pays	Pelin Sergey	0	P1	P2	P3
	KAZ		0	0	0	0
6	Pays	Bayram Nigar	3	P1	P2	P3
	TUR		2	1	1	0
7	Pays	Lyubomir Dimitrov	1	P1	P2	P3
	BUL		3	2	1	0
9	Pays	Lam Balint	3	P1	P2	P3
	HUN		5	0	4	1

**Qualification round**

8	Pays	Budanov Baglan	0	P1	P2	P3
	KAZ		0	0	0	0
9	Pays	Lam Balint	3	P1	P2	P3
	HUN		2	1	1	0
	Pays			P1	P2	P3
	Pays			P1	P2	P3
	Pays			P1	P2	P3
	Pays			P1	P2	P3
	Pays			P1	P2	P3

2	Pays	3	P1	P2	P3
	IRI	6	3	3	0

4	Pays	0	P1	P2	P3
	BUL	0	0	0	0

6	Pays	0	P1	P2	P3
	TUR	2	1	1	0

9	Pays	5	P1	P2	P3
	HUN	5	1	4	0

2	Pays	3	P1	P2	P3
	IRI	5	4	0	1

9	Pays	1	P1	P2	P3
	HUN	2	0	2	0

**REPECHAGE  
LOWER BRANCH**

8	Pays	5	P1	P2	P3
	KAZ	0	0	0	0

7	Pays	0	P1	P2	P3
	BUL	0	0	0	0

8	Pays	0	P1	P2	P3
	KAZ	0	0	0	0

6	Pays	3	P1	P2	P3
	TUR	2	1	1	0

**UPPER BRANCH**

1	Pays	3	P1	P2	P3
	CRO	3	2	1	0

4	Pays	0	P1	P2	P3
	BUL	0	0	0	0

Pays					

Pays					

CATEGORY **120**

STYLE **GR**

2	Pays	Nazari Parsa
	IRI	

6	Pays	Bayram Nigar
	TUR	

1	Pays	Marko Koscevic
	CRO	



**INTERNATIONAL WRESTLING  
TOURNAMENT - JUNIORS GR**  
“PETKO SIRAKOV- IVAN ILIEV, 20-21.03.2010, SOFIA



Category 120

Rank	No	Name	Country	C.P	Falls	E.M.	E.R	Win Points	Lost Points
1	2	Nazari Parsa	IRI	11	1	0	0	14	2
2	9	Lam Balint	HUN	12	1	0	0	14	10
3	6	Bayram Nigar	TUR	6	0	0	0	6	5
3	1	Marko Koscevic	CRO	3	0	0	0	3	3
5	4	Miloslav Metodiev	BUL	3	0	0	0	3	9
5	8	Budanov Baglan	KAZ	5	0	0	0	0	4
7	7	Lyubomir Dimitrov	BUL	1	0	0	0	3	5
8	5	Pelin Sergey	KAZ	0	0	0	0	0	2
9	3	Engin Dagli	TUR	0	0	0	0	0	3